



**EBC produces the largest range of brake pads, brake discs and clutches for street motorcycles, motocross bikes and quads. Here are brief details of our range explained in this catalogue.**

**EBC DISC BRAKE PADS** are available in two product qualities, organic or sintered for all markets.



**STREET USE BRAKE PADS** : a choice of world top selling organic brake pads (with Kevlar® fibre) or heavy duty sintered metal HH brake pads, shown as the FA series in the material selection columns 1 and 6. EBC's sintered metal Double-H™ pads are ideal for heavier and faster street use motorcycles and have longer life than organics - see columns 2 and 7.



**ENDURO, MOTO-X AND QUADS** : EBC offers three choices, one for each of these markets. For Enduro (Tout Terrain) EBC offers its new red coated carbon graphite formula pads with TT suffix (shown in columns 1 & 6). For moto-x use riders choose between "R" suffix sintered metal pads or the latest MXS series sintered pads complete with new slider pins shown in columns 2 and 7.

**EBC BRAKE DISCS** are made in both solid and fully floating designs with a choice of either standard profile or contoured profile for 2007.



**SOLID DISCS**, for rear fitments of most street motorcycles see column 8 and for contour rotors for rear fitments see column 9.

**FLOATING DISCS** - Choose from normal circular rotor designs in columns 3, 4, and 8, or new Contour profile rotors in columns 5 and 9. Please note front Pro-lite contour rotors are universal for left and right sides of the motorcycle.

**EBC CLUTCH KITS** EBC manufacture replacement clutch plate sets and complete clutch kits which include springs and unlined plates.



- Standard lined plates carry a CK prefix.
- Complete clutch kits with springs and unlined plates are numbered DRC for moto-x or Kevlar® lined friction plates with springs (no steel plates) carry SRC prefix).
- Extra plate clutch kits for moto-x use numbers DRC and add suffix EP for extra plate.

**EBC BRAKE SHOES** Now made with high pressure die cast alloys and lined with asbestos free premium quality linings in either standard design or WG grooved design for enduro/moto-x use.



**EBC produziert das weltweit größte Programm an Bremsklötzen, Bremsscheiben und Kupplungen für Straßen- und Geländemotorräder sowie Quads. Hier finden Sie eine kurze Übersicht des Lieferprogramms.**

**BREMSKLÖTZE** sind generell in zwei Qualitäten für alle Einsatzbereiche lieferbar: Organisch oder Sintermetall.



**BREMSKLÖTZE FÜR STRAßENEINSATZ:** Eine Auswahl der weltweit am häufigsten verkauften organischen Bremsklötze mit Kevlar® Fasern finden Sie in der Verwendungsliste des Kataloges in den Spalten 1 und 6 (Bremsklötze/Bremsbacken für vorne oder hinten) als FA gekennzeichnet. Double-H Sinterklötze für höchste Beanspruchung bei schweren oder schnellen Motorrädern mit einer stark verbesserten Lebensdauer zeigen wir in den Spalten 2 und 7 (HH Pads).



**BREMSKLÖTZE FÜR ENDUROS, MOTO-X UND QUADS:** EBC bietet für jeden Einsatzzweck eine spezielle Auswahl an Bremsklötzen. Für das Endurosegment wurden Carbon/Graphite Bremsklötze mit rot beschichteten Rückenplatten neu entwickelt - erkennbar am Zusatz TT (Tout Terrain). Die FA/TT Beläge finden Sie in den Spalten 1 und 6 (Bremsklötze/Bremsbacken für vorne oder hinten). Für den Moto-X Bereich können Sie wählen zwischen Sinterbelägen mit dem Zusatz „R“ oder „MX-S“, der neuesten Entwicklung, die komplett mit Sechskant-Gleitstiften (Slider Pins) geliefert werden. Beide Qualitäten finden Sie in den Spalten 2 und 7 (HH Pads).

**EBC BREMSSCHEIBEN** werden als starre oder vollschwimmende Bremsscheiben in Standard- oder Contour Profil angeboten.



**STARRE BREMSSCHEIBEN** für hinten finden Sie als Standard in Spalte 8 und als Contour in Spalte 9.

**VOLLSCHWIMMENDE BREMSSCHEIBEN (FULL FLOATER)** in Standard Profil zeigen wir in den Spalten 3, 4 und 8. In Contour Profil in den Spalten 7 und 9. Bitte beachten Sie, dass die vorderen Pro-Lite Contour Scheiben für links und rechts identisch sind.

**EBC KUPPLUNGSSÄTZE** EBC stellt sowohl Standard Kupplungssätze als auch komplette Sätze mit verstärkten Kupplungsfedern und Stahlscheiben her.



- Standard Kupplungssätze beginnen mit "CK"
- Komplett Kupplungssätze mit verstärkten Federn und Stahlscheiben für Moto-X beginnen mit "DRC" oder für Straßeneinsatz mit "SRC"
- Komplett Kupplungssätze, die mit einer zusätzlichen Lamelle und Stahlscheibe versehen sind, sind mit "DRC" und dem Zusatz "EP" gekennzeichnet

**EBC BREMSBACKEN** Hergestellt aus Aluminium im Hochdruck-Einspritzverfahren und versehen mit asbestfreien Premium Belägen sind in Standarddesign oder für den Enduro/Moto-X Einsatz mit Nuten als WG (water grooved design) lieferbar.



**EBC produce la gama más grande de los pastillas del freno, discos del freno y embrages para las motocicletas de la calle, las bicis y los cuadrángulos de los motocross. Aquí están los breve detalles de nuestra gama explicada en este catálogo.**

**PASTILLAS DEL FRENO DE DISCO DE EBC** estan disponible en dos calidades del producto, orgánico o sinterizado para todos los mercados.



**PASTILLAS DEL FRENO DEL USO DE LA CALLE** Una opción de los cojines orgánicos vendedores superiores del freno del mundo (con la fibra de Kevlar®) o pasillas sinterizados resistentes del freno del metal HH, demostrado como la serie del FA en las columnas materiales 1 y 6 de la selección. Las pastillas sinterizados de Double-H™ del metal de EBC son ideales para motocicletas más pesadas y más rápidas del uso de la calle y hacen que una vida más larga que los orgánicos - vea las columnas 2 y 7.

**ENDURO, MOTO-X Y CUADRÁNGULOS** : EBC ofrece tres opciones, una para cada uno de estos mercados. Para Enduro (tout el terreno) EBC ofrece sus pastillas revestidos rojos nuevos del fórmula del grafito del carbón con el sufijo del TT (demostrado en las columnas 1 y 6). Para el uso del moto-x los jinetes eligen entre los cojines sinterizados sufijo del metal de "R" o los cojines sinterizados la serie más última de MXS completos con los pernos nuevos del resbalador demostrados en las columnas 2 y 7.

**DISCOS DEL FRENO DE EBC** se hacen en sólido y diseños completamente flotantes con una opción de cualquier perfil estándar o del perfil contorneado para 2007.



**DISCOS SÓLIDOS**, para los mobiliarios posteriores de la mayoría de la calle las motocicletas ven la columna 8 y para los rotores del contorno para los mobiliarios posteriores ver la columna 9.

**DISCOS FLOTANTES** - Elija de diseños circulares normales del rotor en las columnas 3, 4, y 8, o rotores nuevos del perfil del contorno en las columnas 5 y 9. Rotores delanteros del contorno de la nota los Favorables-lite son por favor universales para los lados izquierdos y derechos de la motocicleta.

**KITS DEL EMBRAGUE DE EBC** La placa de embrague del reemplazo de la fabricación de EBC fija y termina los kits del embrague que incluyen los resortes y las placas sin forro.



- Las placas alineadas estándares llevan un prefijo de CK.
- Los kits completos del embrague con los resortes y las placas sin forro se numeran DRC para el moto-x o SRC para la calle.
- Los kits adicionales del embrague de la placa para el moto-x utilizan los números DRC y agregan a EP del sufijo para la placa adicional.

**EBC BRAKE SHOES** Ahora hecho con el dado de alta presión eche las aleaciones y alineó con las guarniciones superiores libres de la calidad del asbesto en o diseño de estándar o el WG acanaló el diseño para el uso de enduro/moto-x.



**EBC fabrique la plus large gamme de plaquettes de frein, disques de frein et d'embrayages pour les motos de route, de tout terrain ainsi que les quads. Voici quelques détails de notre gamme présentée dans ce catalogue.**

**LES PLAQUETTES DE FREIN** sont disponibles en deux qualités, organique et métal fritté pour toutes les utilisations.



**LES PLAQUETTES DE FREIN POUR LES MOTOS DE ROUTE** : un choix entre nos plaquettes organique best seller (contenant des fibres Kevlar®), indiquées dans les colonnes 1 et 6 (série FA), et nos plaquettes haute performance HH en métal fritté, indiquées dans les colonnes 2 et 7, conseillées pour les motos de moyenne et grosse cylindrée et des motos sportives, et qui bénéficient d'une longévité accrue par rapport aux plaquettes organiques.

**ENDURO, MX ET QUAD** : EBC offre trois qualités, chacune spécifique à chaque utilisation. Pour l'Enduro et Tout Terrain, EBC propose ses nouvelles plaquettes "TT" en graphite de carbone (avec une plaque de couleur rouge), qui figurent dans les colonnes 1 & 6). Pour une utilisation en cross, il y a le choix entre les plaquettes "R" en métal fritté ou les toutes dernières plaquettes "MXS" en métal fritté avec de nouvelles goupilles, se référer aux colonnes 2 et 7.

**LES DISQUES DE FREIN EBC** sont proposés en versions fixes et flottants, avec un choix de profils standard ou découpés en 2007.



**LES DISQUES FIXES**, qui se montent à l'arrière de la plupart des motos de route sont indiqués à la colonne 8. Se référer à la colonne 9 pour les disques de profil découpé.

**LES DISQUES FLOTTANTS** - les disques à profil rond sont indiqués dans les colonnes 3, 4, et 8, les nouveaux disques à profil découpé dans les colonnes 5 et 9. Les disques Pro-lite à profil découpé qui se montent à l'avant sont universels (côtés gauche et droits).

**LES EMBRAYAGES EBC** sont proposés en kits de disques garnis ou kits complets, comprenant les ressorts et disques non-garnis.



- Les kits de disques garnis standards ont l'appellation CK.
- Les kits complets ont l'appellation DRC pour les motos de tout terrain et SRC pour les motos de route.
- Pour les kits avec un disque supplémentaire pour le tout terrain, utiliser la référence DRC et ajouter le suffixe EP.

**LES MACHOIRES EBC** sont maintenant fabriquées avec des alliages coulés à haute pression, et utilisent des garnitures sans amiante. Disponibles en versions standard et rainurés (appellation WG) pour une utilisation enduro/tout terrain.



**EBC produce la più ampia gamma di pastiglie freno, dischi freno e frizioni per moto da strada, da motocross e Quad. Ecco alcuni dettagli dei prodotti che troverete nel nostro ricco catalogo.**

**PASTIGLIE FRENO** : disponibili in due mescole, organiche o sinterizzate.



**PASTIGLIE PER USO STRADALE** : un'ampia scelta delle pastiglie organiche più vendute (con fibra di Kevlar®) oppure, nella serie HH, pastiglie in metallo sinterizzato. La serie FA va scelta nelle colonne 1 e 6 della selezione materiali. Le pastiglie sinterizzate HH della EBC sono ideali per essere utilizzate su moto stradali sportive o pesanti ed offrono una durata superiore alle mescole organiche - vedi colonne 2 e 7.

**ENDURO, MOTOCROSS, QUAD** : EBC offre tre scelte, una per ognuno dei tre mercati. Per l'enduro (Tout Terrain) EBC offre le sue nuove pastiglie rosse con formula di carbonio e grafite col suffisso TT (mostrate nelle colonne 1 e 6). Gli utilizzatori di moto da cross possono scegliere fra le pastiglie sinterizzate della linea R o le nuove sinterizzate della linea MX-S complete dei nuovi perni (mostrate nelle colonne 2 e 7)

**DICHI FRENO EBC** : sono prodotti in versione normale o completamente flottante e possono avere disegno standard oppure, novità del 2007 profilo sagomato (Contour).



**DISCHI STANDARD** : per applicazioni posteriori delle moto da strada più diffuse, vedere la colonna 8, per i dischi sagomati posteriori, vedere la colonna 9.

**DISCHI FLOTTANTI** : scegliere i dischi con design normale dalle colonne 3, 4, 8 oppure i nuovi dischi sagomati nelle colonne 5 e 9. **ATTENZIONE** : i dischi anteriori sagomati Pro-Lite possono essere montati sia sul lato destro sia su quello sinistro indifferentemente.

**KIT FRIZIONI EBC** : set di dischi di ricambio conformi agli originali e kit completi che includono molle e dischi in ferro.



- i dischi frizione standard hanno il suffisso CK
- i kit frizione completi di dischi e molle hanno il suffisso DRC per ne moto da cross e SRC per le moto da strada
- kit frizione con disco supplementare per moto da cross usare il numero DRC e il suffisso EP per il disco extra

**GANASCE EBC** : vengono ora prodotte con alluminio in presso-fusione e ricoperte con mescole di alta qualità (senza amianto) sia per i disegni standard sia per i disegni scanalati WG per uso enduro e motocross.

# INDEX

## BRAKE APPLICATIONS

|                                     |       |                                      |        |
|-------------------------------------|-------|--------------------------------------|--------|
| Japanese Built Motorcycles .....    | 14-50 | US Built Motorcycles.....            | 52-61  |
| Road Racing Motorcycles.....        | 51    | Non-Japanese Built Motorcycles ..... | 62-117 |
| Pads for Aftermarket Calipers ..... | 51    |                                      |        |

## DISC PAD BUYERS GUIDE

|  |         |
|--|---------|
| Buyers Guide - Disc Brake Pads .....           | 116-268 |
| Brake Pad Competitor Interchange Numbers ..... | 269-277 |

## SHOE BUYERS GUIDE

|   |         |
|---|---------|
| Buyers Guide - Brake Shoes .....                | 278-298 |
| Brake Shoe Illustrations.....                   | 299-307 |
| Brake Shoe Competitor Interchange Numbers ..... | 308-309 |

## CLUTCH APPLICATIONS

|   |         |
|---|---------|
| Clutch Introduction Page .....            | 310     |
| Clutch Kits/SRC's/DRC's and Springs ..... | 311-324 |

## BUYERS GUIDE CLUTCH

|                                  |         |
|----------------------------------|---------|
| Buyers Guide - Clutch Kits ..... | 325-342 |
|----------------------------------|---------|

## RACE/SPECIAL DISCS & CALIPERS

|   |         |
|---|---------|
| Supermoto Oversize Disc Conversions.....          | 343     |
| Oversize MC Disc Front Floating Conversions ..... | 343-344 |
| Race Disc Programme.....                          | 344-345 |
| Special Disc Ordering Instructions .....          | 346     |

## DISC BUYERS GUIDE

|                                       |         |
|---------------------------------------|---------|
| Buyers Guide - Streetbike Discs ..... | 347-370 |
| Buyers Guide - Off Road Discs .....   | 371-380 |

## ACCESSORY PAGES

|                           |     |                                  |     |
|---------------------------|-----|----------------------------------|-----|
| S & B Filters .....       | 381 | Baffle Pac .....                 | 384 |
| Hy-Tech Racing Reeds..... | 382 | Brake Fluid.....                 | 384 |
| RD Engineering Jets.....  | 383 | Galindo Grips & Baja Grips ..... | 385 |
| Ledar Nozzles .....       | 384 |                                  |     |

# TECHNICAL SECTION - BRAKE DISCS

STREET FRONT

- **THE ONLY** complete range of MC discs
- Hub and rotor complete units, bolt on and go
- Lightweight forged aluminium centre hubs
- Roll forged **BILLET STEEL** disc rings
- Sturdy riveted construction

The EBC Pro-lite series has become an aftermarket standard worldwide because of its very close similarity to the original disc but offering a higher friction (18% extra) braking power over stainless steel and being a safe, riveted, sturdy construction as opposed to the risky circlip system used by some of our competitors. If the OEM manufacturers thought circlips were a good idea, they would have put them on the original bikes. It is also worth explaining to your customers the false economy of buying replacement rotor ring kits with the risky circlip system. (See buyers guide for hub colours).

## New Contour Discs

### Front floating designs

A universal rotor that fits both left and right sides of the motorcycle, made with tough semi-stainless rotor rings mounted on forged aluminium centre hubs with the traditional EBC high security riveted hardware. Contour discs not only look modern, they are lighter than most other aftermarket and original discs. (All come with gold centres).

### Rear solid designs

With contoured profile to reduce weight, rear versions of this new programme are made in HPSR steel and zinc plated to avoid corrosion.



How To Order

Select disc no. from application pages. Prefix with "MD" for Prolite and then suffix with "LS" or "RS" for left or right. For new contour discs use suffix "C".

STREET REAR

- Unique birdswing drill pattern prevents ridges
- Tough HPSR steel prevents cracking
- Silver zinc finish to prevent corrosion

Standard replacement discs for modern streetbikes made with the EBC unique birdswing drill pattern. Holes overlap such that as pad and disc wears, no ridges are generated, pads stay flatter and last longer.



How To Order

Select disc no. from application pages and prefix with "MD"

SUPERMOTO

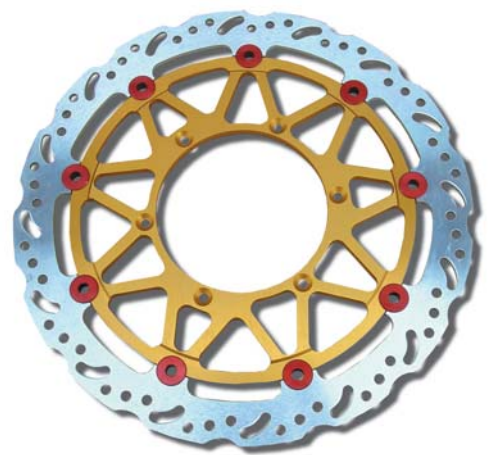

320mm oversize conversion discs with brackets designed to fit most standard wheel hubs on modern enduro bikes.

# TECHNICAL SECTION - BRAKE PADS



## Organic Streetbike Pads

Made in our own factory in Bristol, England, the EBC Kevlar series has now been re-named NAO series or Non Asbestos Organic, although we still use the famous Dupont Kevlar® fibre in conjunction with other high tech fibres that have come on the market. The NAO series are a superb all round value-for-money replacement for all levels of motorcycle and are still extremely popular with many riders who prefer the "feel" of organic pads. NAO series are fully TUV tested and KBA certified and conform to the new ECE R90 brake regulations which are about to storm the European market. EBC is at the forefront of this technology and will be the first on the market to offer Reg. 90 approved pads and packaging.

- Still number 1 selling EBC formulation
- German Motorrad magazine tests rated these above most organics
- KBA Approved and will comply with Reg90
- Typical organic "feel" which many riders prefer

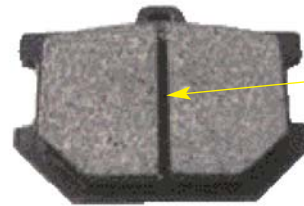
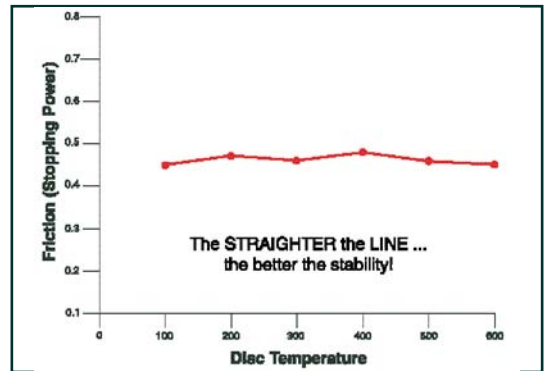

Most EBC organic pads have expansion groove which reduces noise and prevents cracking



Aramid fibre compound with non-ferrous particles to prevent surface "scorching" under load

**How To Order**

Select pad no. from application pages - material is pre-selected

## Double-H Sintered Streetbike Pads

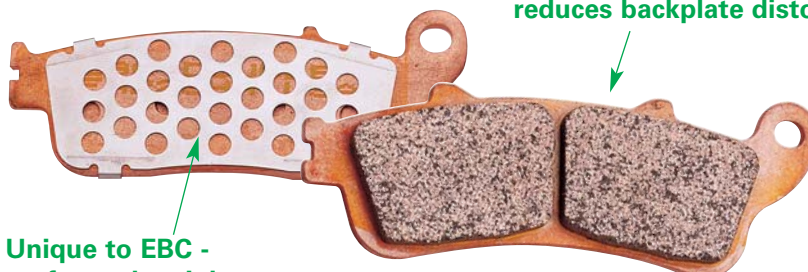

Unique to EBC - perforated stainless steel heat radiator plates

Double segment compact improves venting and reduces backplate distortion



**How To Order**

Select pad no. from application pages - suffix with "HH"

Made in our Cleveland, USA, state of the art manufacturing facility, the "Double-H" sintered pads have set the levels by which all other pads are now judged in the European market. Boasting the highest "HH" friction rating and a lifetime which is the envy of our competition, the "Double-H" pads are extended in their application range for this year and are available in a new quieter running, faster bedding formulation, further raising the attractive commercial features of this already top selling product line.

- HH rated - highest friction rating possible
- Huge mileage - 20,000 miles plus
- Perfect in hot dry or cold and wet conditions
- Consistent performance throughout life

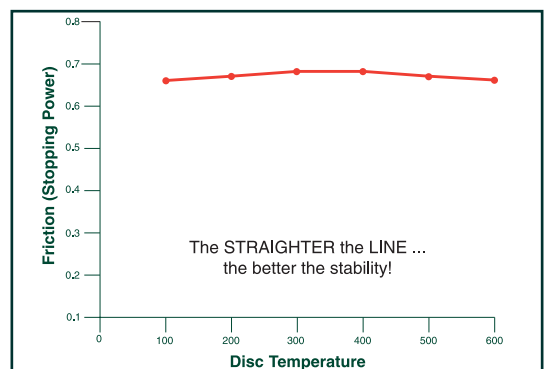

# TECHNICAL SECTION - ROADRACE BRAKES

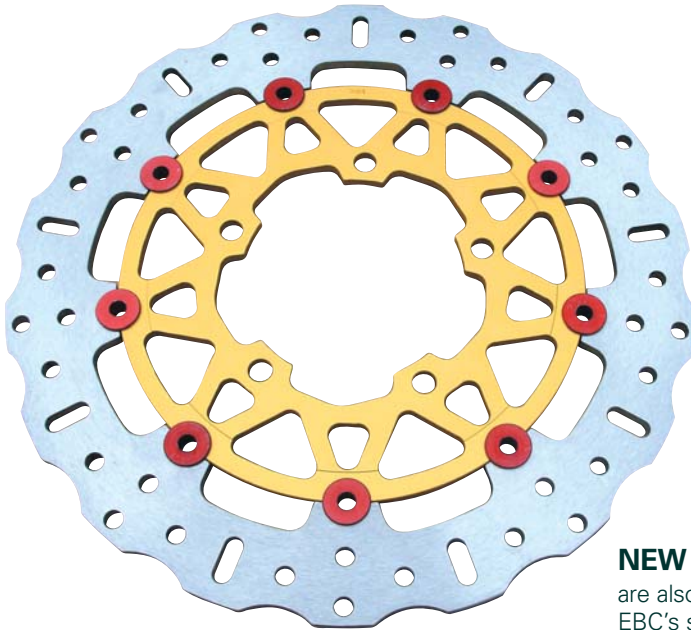

**How To Order**

See separate race section and suffix with **LD/RD** or **CR** for contour

## NEW CONTOUR VERSION ROTORS

are also available and feature stainless steel rotor rings with EBC's scraper slot and hole combination system. To order quote part number with "CR" suffix, for example MD3058LD becomes MD3058CR. Similar to LD/RD suffix, the contour series features fully rebuildable button and clip design as above.

## Double-H Sintered **KIT** Superbike & Race Pads

Following the installation of our "pressure sintering" furnaces at our Cleveland, USA facility a whole new rule book has been established on performance levels of sintered metal brakes. Our first offering for the superbike and road race market is the SB151HH pressure sintered copper brake formulation, which offers

- Faster brake bed in
- Highest heat stability
- Maximum braking power
- Consistent performance throughout life



For Part no's available in GFA/HH kit range see 2005 price list

**How To Order**

Select pad no. from application pages - suffix with "HH" and prefix with "GFA"

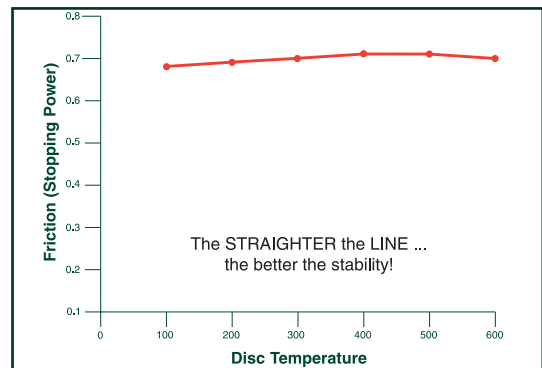

## NEW FOR 2007 - GFA SERIES OFF ROAD RACE PADS

Enduro riders have often praised the stopping power of our GFA HH series race pad materials but asked for lower heat transfer which means the addition of a shim. Below is a list of available part numbers of these new Enduro race brakes which offer superb durability and now reduced heat transfer.

### Available Parts

GFA208HH  
GFA346HH  
GFA367HH  
GFA368HH



# TECHNICAL SECTION - MX/ATV BRAKE DISCS

## Front MX Brake Discs

**With circular or contoured profile**

- Front or rear fitments
- New lightweight construction
- Radical new profile
- Heat treated carbon steel
- Gold zinc anodised

EBC still offer, due to popular demand, a circular version of all the off road rotor range but now introduce its new contoured profile rotor in addition.

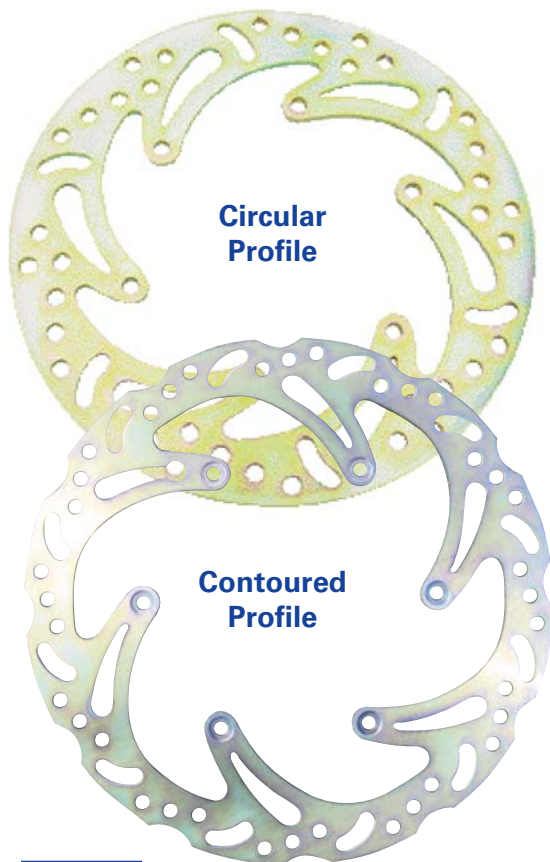

**How To Order**

Select disc no. from application pages and prefix with **"MD"**. Add suffix **"C"** for contoured profile.

Select disc no. from application pages and prefix with **"MD"**

**How To Order**

## Heavy Duty Heat Treated MX Rear & ATV Front & Rear Discs

- Front or rear fitments
- Strong heavy duty design
- Heat treated carbon steel
- Gold zinc anodised

An extended range of our successful range of heat treated carbon steel replacement brake rotors for the general replacement market for moto-x and ATV machinery.

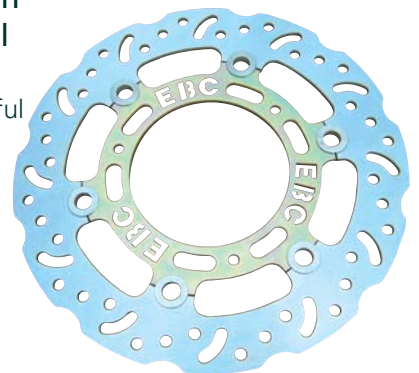

## Oversize MX Front Floating Disc Conversions

**(Also 250mm for 80/85cc MX Bikes)**

- 280mm oversize design or
- 250mm oversize design
- Fully floating construction
- Heat treated carbon steel
- Complete with brackets
- Front applications only

This extremely popular range of oversize discs has become a worldwide number one seller. The optimum 250/280mm design gives a significant improvement to stopping power but also great modulational/control without the risk of 'grounding' on excessively over diameter units. The rotors are quick and easy to fit with beautifully crafted brackets made by Ted Devol in the United States, available for all recent modern moto-x machines.

**How To Order**

Select disc no. from application pages and prefix with **"OS"**

# TECHNICAL SECTION - MOTO-X & ATV DISC PADS

## TT Series (Tout Terrain) Enduro Compound Pads

For some eight years now this successful carbon graphite formula has been the choice of top Enduro and moto-x riders for certain conditions around the world. The main advantage of this type of material is its lack of heat generation or conduction, which keeps both the rotor and caliper cool. Top Enduro and Hare Scrambles USA riders prefer this material for fast and dry riding conditions. The material is also very useable for standard sport ATV useage. Also TUV tested and KBA approved for street use on Enduro bikes.



**How  
To  
Order**

Select pad no. from application pages and add suffix **"TT"**.

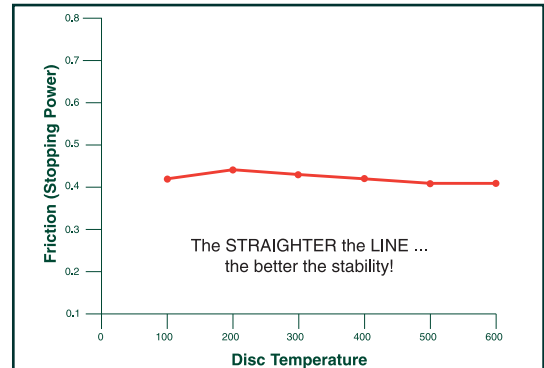

## Sintered Moto-X Race Pads with Hex Drive Slider Pin Kits

- Highest HH rated friction for maximum stopping
- Include new "Hex Drive" slider pins (on most applications)
- All weather performance formulation
- Excellent race material for moto-x and ATV

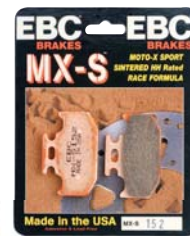

Complete with new external "hex" drive head slider pins (on most applications)

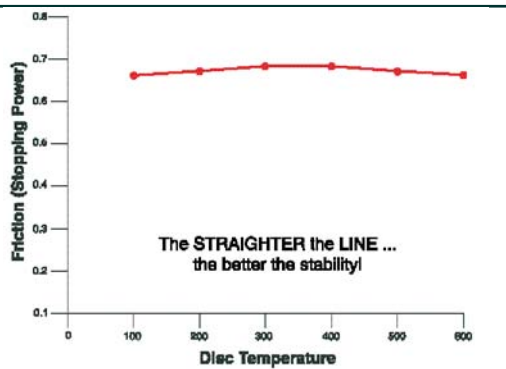

**How  
To  
Order**

Select pad no. from application pages and prefix with **"MXS"**

## Sintered Metal ATV and Moto-X brake pads

A sintered copper material made in our own USA facility, the "R" series of heavy duty ATV and moto-x pads have become an aftermarket standard offering high durability, complete resistance to mud, water, sand and grit etc. offering reduced disc damage and long pad life.



**How  
To  
Order**

Select pad no. from application pages and suffix with **"R"**

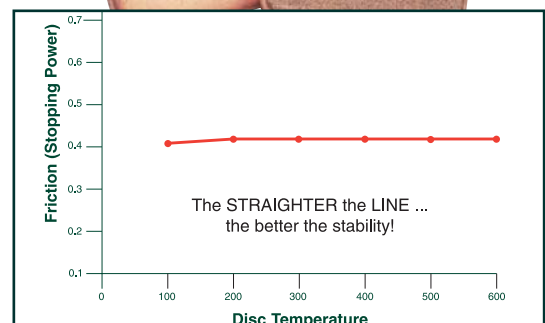



# EBC PROMOTIONAL MATERIAL



Banners and stickers are always available in reasonable quantities - see your representative.

**The Promotional Items below are available from various EBC promotions throughout the year or can be purchased at subsidised prices at any time from your distributor.**

EBC's new top of the range 3/4 length rally jacket, made with breathable Tactel® fabric has built in hood, velcro cuffs, zip side pockets and inside pocket plus discreet logo on chest and collar areas.

A jacket of this design and quality would retail in the high street for £89 and is available at a subsidised price to distributors for dealer promotions.



**EBC Mechanics Overalls**  
 Sizes - M, L, XL, XXL  
 Order no. - OVER  
 (+size e.g. OVER L)



**EBC Logo Fleece**  
 Sizes - M, L, XL, XL  
 Order no. - FLEECE  
 (+size e.g. FLEECE-M, FLEECE-L)



**Counter Display Stands**  
 For details and part numbers, see page 13.



**EBC Logo Wall Clock**  
 Order no. - CLOCK



**EBC Logo Baseball Cap**  
 Order no. - CAP



**EBC Logo Paddock Umbrella**  
 Over 1 metre in diameter  
 Order no. - UB1



**EBC Product Rack**  
 (16 pegs - space for upto 160 sets of pads)  
 Order no. - RACK



**EBC Logo Carrier Bags**  
 Sold in packs of 100 or 500  
 Order no. - BAGS 100  
 BAGS 500

All rear rotor  
thicknesses 5mm  
or 0.2"

**FRONT**

**NARROW BAND SERIES**

**FSD001 (2" bore)**  
**FSD002 (2.25" bore)**  
**Solid Rotor**

This rotor will accept pads FA216/3, FA299, FA381 & FA400.

**NARROW BAND SERIES**

**FSD003 (2" bore)**  
**FSD004 (2.25" bore)**  
**5 button full floater**

This rotor will accept pads FA216/3, FA299, FA381 & FA400.

**NARROW BAND SERIES**

**FSD005 (2" bore)**  
**FSD006 (2.25" bore)**  
**5 button full floater**

This rotor will accept pads FA216/3, FA299, FA381 & FA400.

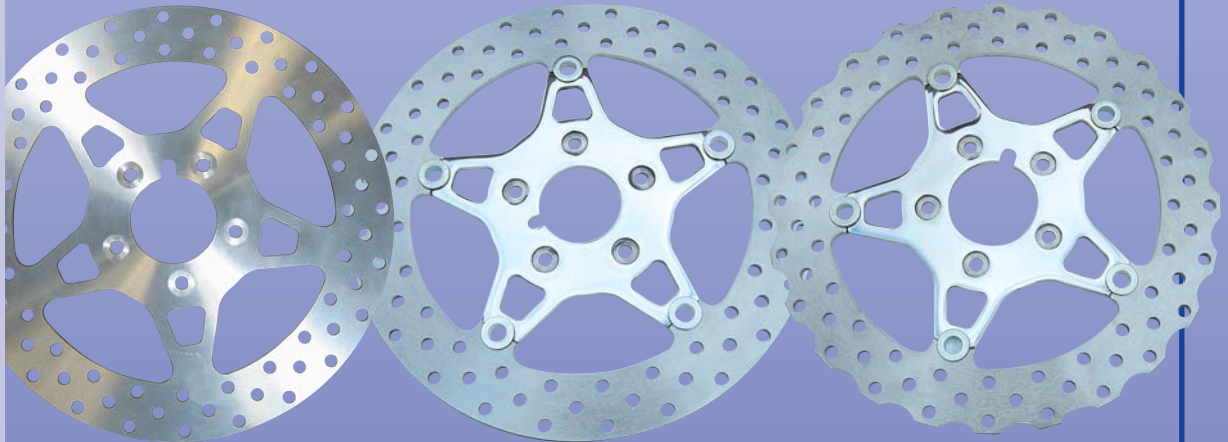

**WIDE BAND SERIES**

**FSD007 (2" bore)**  
**FSD008 (2.25" bore)**  
**Solid Rotor**

This rotor will accept pads FA94, FA216/3, FA299, FA381 & FA400.

**WIDE BAND SERIES**

**FSD009 (2" bore)**  
**FSD010 (2.25" bore)**  
**5 button full floater**

This rotor will accept pads FA94, FA216/3, FA299, FA381 & FA400.

**WIDE BAND SERIES**

**FSD011 (2" bore)**  
**FSD012 (2.25" bore)**  
**5 button full floater**

This rotor will accept pads FA94, FA216/3, FA299, FA381 & FA400.

All rear rotor  
thicknesses 6mm  
or 0.24"

**REAR**

**NARROW BAND SERIES**

**RSD013 (2" bore)**  
**RSD014 (2.25" bore)**  
**10 button full floater**

This rotor will accept pads FA216/3, FA299, FA387 & FA400.

**NARROW BAND SERIES**

**RSD015 (2" bore)**  
**RSD016 (2.25" bore)**  
**10 button full floater**

This rotor will accept pads FA216/3, FA299, FA387 & FA400.

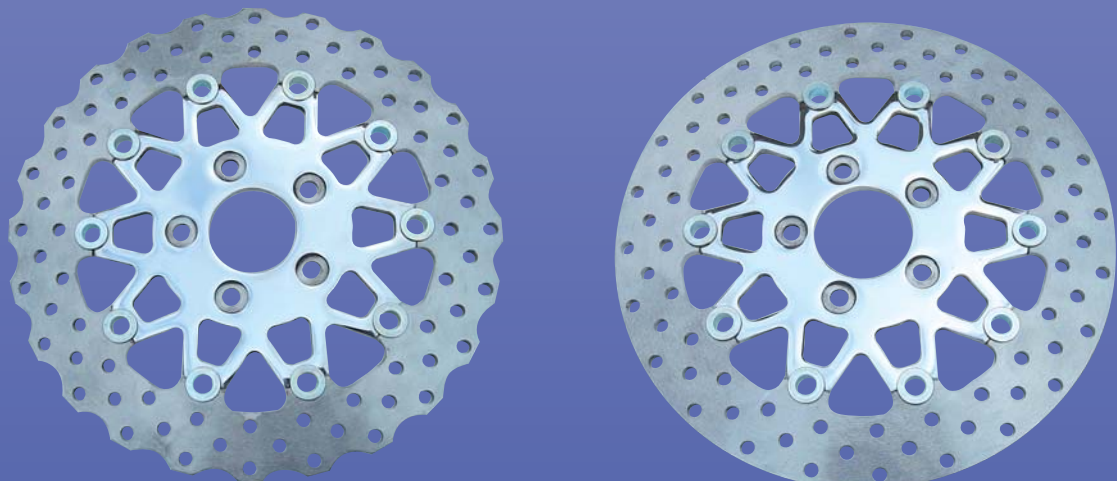

**WIDE BAND SERIES**

**RSD017 (2" bore)**  
**RSD018 (2.25" bore)**  
**10 button full floater**

This rotor will accept pads FA216/3, FA200, FA201, FA299, FA387 & FA400.

**WIDE BAND SERIES**

**RSD019 (2" bore)**  
**RSD020 (2.25" bore)**  
**10 button full floater**

This rotor will accept pads FA216/3, FA200, FA201, FA299, FA387 & FA400.

# EBC Stainless Steel Custom Rotors for American Motorcycles

All rotors fit standard 5 bolt hubs and are 11.5 inch diameter.  
Front rotors use 5mm rotor thickness, rears use 6mm rotor thickness.

| New # for Polished Stainless Rotors (Universal left or right fitment) | Old EBC # As in Listings |                                       |
|---|--------------------------|---------------------------------------|
| FSD007  | MD506                    | Solid wide band                       |
| FSD008  | MD512                    | Solid wide band                       |
| FSD009  | MD506                    | 5 button floater wide band            |
| FSD010  | MD512                    | 5 button floater wide band            |
| FSD011C   | MD506                    | 5 button floater contour wide band    |
| FSD012C   | MD512                    | 5 button floater contour wide band    |
| RSD017C   | MD508                    | 10 button floater contour wide band   |
| RSD018C   | MD513                    | 10 button floater contour wide band   |
| RSD019  | MD508                    | 10 button floater wide band           |
| RSD020  | MD513                    | 10 button floater wide band           |
| FSD001  | MD506                    | Solid narrow band                     |
| FSD002  | MD512                    | Solid narrow band                     |
| FSD003  | MD506                    | 5 button floater narrow band          |
| FSD004  | MD512                    | 5 button floater narrow band          |
| FSD005C   | MD506                    | 5 button floater contour narrow band  |
| FSD006C   | MD512                    | 5 button floater contour narrow band  |
| RSD013C   | MD508                    | 10 button floater contour narrow band |
| RSD014C   | MD513                    | 10 button floater contour narrow band |
| RSD015  | MD508                    | 10 button floater narrow band         |
| RSD016  | MD513                    | 10 button floater narrow band         |



## WHICH PADS WORK BEST ...

For almost 30 years Harley riders have appreciated the softer organic pads (EBC Kevlar® formula pads) which offer fingertip stopping, great brake feel and much less rotor damage. EBC now also offer longer lasting American made sintered metal pads for improved life.



# Polished "Streetfighter" Discs for Sport & Custom Street Bikes

## PART NUMBERS AVAILABLE

### **HONDA**

MD1003CC  
MD1014CC  
MD1134CC  
MD1137CC  
MD1141CC  
MD1152CC  
MD1153CC

### **KAWASAKI**

MD4012CC  
MD4022CC  
MD4152CC  
MD4154CC  
MD4155CC

### **SUZUKI**

MD3058CC  
MD3089CC  
MD3091CC

### **YAMAHA**

MD2074CC  
MD2082CC  
MD2094CC  
MD2095CC

**NEW FOR  
2007**

Slotted scraper holes  
help clean pads  
better and prevent  
pad pick-up on rotor.

Stainless steel rotor  
blades

Lightweight  
contoured  
rotor blade  
profile

Lightweight forged  
alloy centre hub  
which is then  
polished and  
lacquered

# The EBC 2007 4 or More Dealer Brake Disc Promotion

To enable dealers to have a physical example of our brake discs, we have created 4 beautiful displays which are actual EBC discs (made 1mm undersize so they cannot be used) on heavy plastic stands. There are 3 disc stand designs with part numbers shown below. These are free of charge to distributors and allocated according to turnover UPON REQUEST. Distributors should order these to EBC who will verify for realistic quantities requested and supply accordingly. In order for the dealer to obtain one of these displays, he needs to order 4 BRAKE DISCS from that group, in other words, to get the Pro-lite display he needs to order any 4 Pro-lite discs. Each display comes complete with a dual purpose leaflet holder which either attaches to the disc display using the hooks on its front, or can be left free standing as shown in the illustration below.



Part No. MCD-TWIN

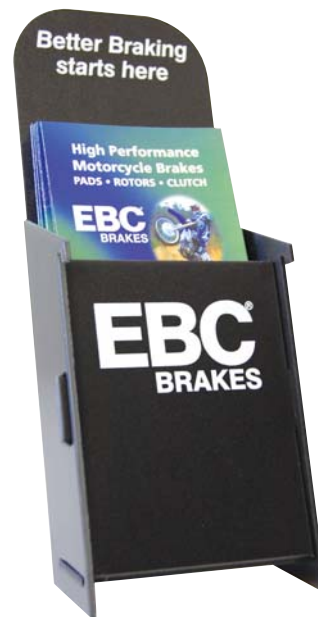

Part No. MLF-TWIN (Info for Big Twins)

Part No. MLF-IMP (Info for all Japanese and European produced motorcycles)



Part No. MCD-MX

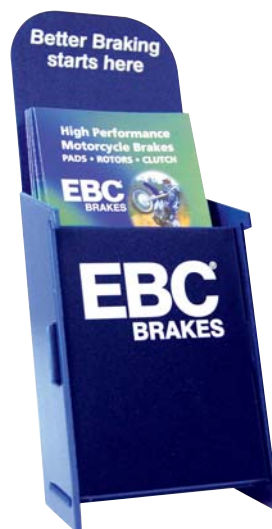

Part No. MLF-MX (Info for MX and ATV)



Part No. MCD-SPORT

# JAPANESE Built Motorcycles

APPLICATIONS

BRAKE



|   |       | Front/Avant/Vorn |                                    |                   | Frente/Anteriere    |  | Rear/Arrière/Hinten |                                    | Posterior/Posteriore |                               |
|---|-------|------------------|------------------------------------|-------------------|---------------------|--|---------------------|------------------------------------|----------------------|-------------------------------|
|   |       | ①                | ②                                  | ③                 | ④                   | ⑤  | ⑥                   | ⑦                                  | ⑧                    | ⑨                             |
| HONDA   |       |                  | Sintered/HH Pads/<br>Grooved shoes | Left/Gauche/Links | Right/Droite/Rechts | Contour Rotor<br>Universal left<br>and right fitment |                     | Sintered/HH Pads/<br>Grooved shoes |                      | Contour Rotor<br>Rear fitment |
| C 50 "All Models"   | 75-93 |                  | H303                               |                   |                     |  |                     | H303                               |                      |                               |
| C 50 N (Single seat model)                                      | 95    |                  | H303                               |                   |                     |  |                     | H304                               |                      |                               |
| C 50 P/S/V/X/Y/1/2 (Single seat model)                          | 96-02 |                  | H303                               |                   |                     |  |                     | H304                               |                      |                               |
| CB 50 J   | 81    |                  | FA40                               |                   |                     | N/A  |                     | H304                               |                      |                               |
| CB 50 V/W Dream 50  | 97-98 |                  | FA197                              | FA197HH           |                     | N/A  |                     | FA131TT                            | N/A                  |                               |
| CD 50 ST/SV/SW/SX Benley 50 S                                   | 96-99 |                  | H304                               |                   |                     |  |                     | H304                               |                      |                               |
| CF 50 Chaly   | 79    |                  | H303                               |                   |                     |  |                     | H303                               |                      |                               |
| CHF 50-1/Scoopy 50 (Drum brake model)                           | 01-05 |                  | H333                               |                   |                     |  |                     | H333                               |                      |                               |
| CL 50 V/X Benley CL50   | 97-99 |                  | H304                               |                   |                     |  |                     | H304                               |                      |                               |
| CR 50 RE/RF   | 84-85 |                  | H333                               | H333G             |                     |  |                     | H333                               | H333G                |                               |
| CRF 50 F4/F5/F6/F7  | 04-07 |                  | H301                               |                   |                     |  |                     | H301                               |                      |                               |
| CRM 50 RN/RP/RR/RT  | 93-96 | FA125TT          | FA125R                             | MD6001D           |                     |  |                     | H304                               |                      |                               |
| MB 5 S  | 80-82 | FA54TT           |                                    |                   |                     | N/A  |                     | H304                               |                      |                               |
| MBX 50 SD/SF  | 83-85 | FA86             | FA86HH                             |                   |                     | N/A  |                     | H304                               |                      |                               |
| MG 50 S/X/1/3 "Magna 50" (AC13-)                                | 95-03 | FA54TT           | FA54HH                             |                   |                     | N/A  |                     | H304                               |                      |                               |
| MP 50 3/DX3 (AC17) Solo   | 03    |                  | H304                               |                   |                     |  |                     | H304                               |                      |                               |
| MRX 50  | 88-   | FA54TT           |                                    |                   |                     | N/A  |                     | H304                               |                      |                               |
| MT 50 SA/SE/SG/SJ/SL  | 80-93 |                  | H304                               | H304G             |                     |  |                     | H304                               | H304G                |                               |
| MTX 50 SC   | 83-84 |                  | H304                               | H304G             |                     |  |                     | H304                               | H304G                |                               |
| NB 50 ME "Aero"   | 84    |                  | H301                               |                   |                     |  |                     | H302                               |                      |                               |
| NB 50 MF/MG/TH "Vision"   | 86-88 |                  | H301                               |                   |                     |  |                     | H302                               |                      |                               |
| NC 50 K1/Z "Express"  | 79-82 |                  | H301                               |                   |                     |  |                     | H301                               |                      |                               |
| NC 50 C "Express 2"   | 82    |                  | H301                               |                   |                     |  |                     | H302                               |                      |                               |
| NC 50 A/B "Express 3 Delux"                                     | 82    |                  | H301                               |                   |                     |  |                     | H302                               |                      |                               |
| NE 50 MF/MG "Vision"  | 86-87 |                  | H301                               |                   |                     |  |                     | H302                               |                      |                               |
| NH 50 "Lead 50 SS"  | 84    | FA176            |                                    | N/A               |                     |  |                     | H302                               |                      |                               |
| NH 50 "Lead AF01/D716"  | 84-85 | FA176            |                                    | N/A               |                     |  |                     | H302                               |                      |                               |
| NJ 50 MDY/M2/MD2 (TD01) Gyro-X                                  | 00-02 |                  | H333                               |                   |                     |  |                     | H333*                              |                      |                               |
| NP 50 D "Melody Mini"   | 83    |                  | H301                               |                   |                     |  |                     | H302                               |                      |                               |
| NPC 50 2/3 (AF59) Bite  | 02-03 |                  | H333                               |                   |                     |  |                     | H333                               |                      |                               |
| NPS 50 1/2/3/5/6/7 (AF58) Zoomer                                | 01-07 |                  | H333                               |                   |                     |  |                     | H333                               |                      |                               |
| NS 50 "Melody"  | 82    |                  | H301                               |                   |                     |  |                     | H302                               |                      |                               |
| NS 50 MSB "Melody Delux"  | 82    |                  | H301                               |                   |                     |  |                     | H302                               |                      |                               |
| NSR 50 FP/FR/FS   | 93-95 | FA86             | FA86HH                             |                   |                     | N/A  |                     | H304                               |                      |                               |
| NSR 50 RV/RW/RX/RY  | 97-00 | FA197            | FA197HH                            |                   | MD1142RS            |  |                     | FA131/3                            | MD1143               |                               |
| NSR 50 SK/SP/SR/SS  | 89-95 | FA86             |                                    |                   | N/A                 |  |                     | H304                               |                      |                               |
| NT 50 F/G/H "Melody Mini"                                       | 85-87 |                  | H301                               |                   |                     |  |                     | H301                               |                      |                               |
| NU 50 MC "Runaway"  | 82    |                  | H333                               |                   |                     |  |                     | H302                               |                      |                               |
| NV 50 MSD "Stream"  | 84    |                  | H302                               |                   |                     |  |                     | H302                               |                      |                               |
| NVS 501SH2/Today 50   | 01-05 |                  | H333                               |                   |                     |  |                     | TBA                                |                      |                               |
| NX 50 A/B/MB "Caren"  | 80-82 |                  | H301                               |                   |                     |  |                     | H302                               |                      |                               |
| PA 50 Camino  | 80    |                  | H322                               |                   |                     |  |                     | H322                               |                      |                               |
| PC 50 K1  | 79    |                  | H301                               |                   |                     |  |                     | H301                               |                      |                               |
| PF 50 M "Novio"   | 75    |                  | H322                               |                   |                     |  |                     | H322                               |                      |                               |
| PK 50 "Wallaro" All models                                      | 90-01 |                  | H333                               |                   |                     |  |                     | H303                               |                      |                               |
| PX 50   | 82-83 |                  | H322                               |                   |                     |  |                     | H302                               |                      |                               |
| PX 50   | 84    |                  | H322                               |                   |                     |  |                     | H337                               |                      |                               |
| PXR 50  | 84    |                  | H335                               |                   |                     |  |                     | H334                               |                      |                               |
| SA 50 J/M/P/R/S "Vision Metin"                                  | 88-95 |                  | H333                               |                   |                     |  |                     | H333                               |                      |                               |
| SFX 50 S/T/V/W/X/Y/1  | 95-04 | FA193            | FA193HH                            | MD906D            |                     |  |                     | H303                               |                      |                               |
| SGX 50 V/W/X/Y/1 "Sky/Sky Deluxe"                               | 97-03 | FA193            | FA193HH                            | MD931D            |                     |  |                     | H303                               |                      |                               |
| SH 50 E/H/K/M/P/DP "City Express"                               | 85-96 |                  | H303                               |                   |                     |  |                     | H336                               |                      |                               |
| SH 50 T "Fifty"/"Scoopy" W/X/Y/1                                | 97-03 | FA193            | FA193HH                            | MD918D            |                     |  |                     | H303                               |                      |                               |
| SJ 50 P/R/S/T/V/W/X "Bali"                                      | 93-99 | FA256            | FA256HH                            | MD923D            |                     |  |                     | H303                               |                      |                               |
| SK 50 MM/MM-YA/MM-YC/MN/MN-YA<br>/MN-YB/MP/MP-YA/MMR/MMT (AF27) |       |                  |                                    |                   |                     |  |                     |                                    |                      |                               |
| "DIO" Drum Front & Rear   |       |                  | H333                               |                   |                     |  |                     | H333                               |                      |                               |
| SK 50 MM-II/MM-YD/MN-II/MP-II<br>(AF28) "DIO SR"                |       |                  | FA257                              |                   | MD919D              |  |                     | H333                               |                      |                               |
| SK 50 MN/III/MP/IV (AF28) "DIO-ZX"                              |       |                  | FA257                              |                   | MD919D              |  |                     | H333                               |                      |                               |

\*-2 Sets Required. ■ - Also available in MX-S race compound, see page 8. ✖ - Oversize and Supermoto disc available - see page 301.

**SAFETY WARNING:- DO NOT USE HH PADS ON REAR UNLESS ALSO USED ON FRONT TO AVOID BRAKE IMBALANCE.**

# JAPANESE Built Motorcycles



HONDA contd.

|  |       | Front/Avant/Vorn                   |                   |                     | Frente/Anteriere                                     |         | Rear/Arrière/Hinten                |         | Posterior/Posteriore          |         |
|--|-------|------------------------------------|-------------------|---------------------|--|---------|------------------------------------|---------|-------------------------------|---------|
|  |       | 1                                  | 2                 | 3                   | 4  | 5       | 6                                  | 7       | 8                             | 9       |
|  |       | Sintered/HH Pads/<br>Grooved shoes | Left/Gauche/Links | Right/Droite/Rechts | Contour Rotor<br>Universal left<br>and right fitment |         | Sintered/HH Pads/<br>Grooved shoes |         | Contour Rotor<br>Rear fitment |         |
| SK 50 MR-II/MMT-II "DIO XR" (AF28)                         |       | FA257                              |                   | MD919D              |  |         | H333                               |         |                               |         |
| SN 50 N/R/S "Giorno"                                       | 94    | H333                               |                   |                     |  |         | H333                               |         |                               |         |
| SS 50 ZK2  | 75-77 | H303                               |                   |                     |  |         | H303                               |         |                               |         |
| SS 50 ZB2  | 77-80 | FA40                               |                   | N/A                 |  |         | H303                               |         |                               |         |
| SRX 50 T/W/X "Joker/Shadow"                                | 97-99 | FA131/3                            |                   | MD931D              |  |         | H303                               |         |                               |         |
| ST 50 J/K "Dax"  | 78-93 | H303                               |                   |                     |  |         | H303                               |         |                               |         |
| SXR 50 W/SW/X/SX   | 98-99 | FA193                              | FA193HH           | MD906D              |  |         | H303                               |         |                               |         |
| X8R-S Super Sport Scooter (SZX 50 SW/SX/SY/S1)             | 98-04 | FA193                              | FA193HH           | MD920D              |  |         | FA234                              |         | MD921D                        |         |
| X8R-X Cross Sport Scooter (SZX 50 XW/XX/XY/X1)             | 98-04 | FA193                              | FA193HH           | MD920D              |  |         | FA234                              |         | MD921D                        |         |
| Tact 50  |       | FA257                              |                   | N/A                 |  |         | H333                               | H333G   |                               |         |
| TC 50 M/P/V "Gyro Canopy" (TA02)                           | 96-00 | H303                               |                   |                     |  |         | H333                               |         |                               |         |
| TC 50 Y/2 (TA02) Gyro Canopy                               | 00-02 | H304                               |                   |                     |  |         | H333                               |         |                               |         |
| TLM 50 F   | 85    | H333                               | H333G             |                     |  |         | H333                               | H333G   |                               |         |
| QR 50 D/E/F  | 83-87 | H301                               |                   |                     |  |         | H302                               |         |                               |         |
| QR 50 M/R/V/W/Y  | 93-03 | H301                               |                   |                     |  |         | H333                               |         |                               |         |
| XR 50 R1/R2/R3   | 01-03 | H301                               |                   |                     |  |         | H301                               |         |                               |         |
| XR 50 M5 (AD14) Motard                                     | 05    | FA197                              | FA197HH           |                     | TBA  |         | FA131TT                            |         | TBA                           |         |
| XZ 50 1/2 "APE-AC16"                                       | 01-02 | H304                               |                   |                     |  |         | H304                               |         |                               |         |
| Z 50 R "All Models"  | 79-86 | H301                               |                   |                     |  |         | H301                               |         |                               |         |
| CR 60 Rf/RG  | 85-86 | H333                               | H333G             |                     |  |         | H333                               | H333G   |                               |         |
| ATC 70 "All Models"  | 78-85 | None                               |                   |                     |  |         | H310                               |         |                               |         |
| C 70 "All Models"  | 75-85 | H303                               |                   |                     |  |         | H303                               |         |                               |         |
| CF 70 C  | 77-78 | H303                               |                   |                     |  |         | H303                               |         |                               |         |
| CRF 70 F4/F5/F6/F7   | 04-07 | H333                               | H333G             |                     |  |         | H333                               | H333G   |                               |         |
| TRX 70 Fourtrax  | 86-87 | H346*                              | H346G*            |                     |  |         | H306                               | H306G   |                               |         |
| XR 70 RV/RW/RX/RY/R1/R2/R3                                 | 97-03 | H333                               | H333G             |                     |  |         | H333                               | H333G   |                               |         |
| CRM 75 RK/RL/RM/RP/RR                                      | 89-94 | FA125TT                            | FA125R■           | MD6001D             |  | MD6001C | H304                               | H304G   |                               |         |
| NF 75  | 79    | H303                               |                   |                     |  |         | H303                               |         |                               |         |
| NSR 75 N/P/R/X/Y (NS-1)                                    | 92-00 | FA197                              | FA197HH           |                     | MD1142RS   |         | FA131/2                            |         | MD1143                        |         |
| SA 75 Vision   | 89-   | H303                               |                   |                     |  |         | H333                               |         |                               |         |
| SH 75 Scoopy H/K/M/P/DP/S/DS                               | 87-95 | H303                               |                   |                     |  |         | H336                               |         |                               |         |
| XR 75 K4   | 75-78 | H304                               | H304G             |                     |  |         | H303                               | H303G   |                               |         |
| XR 75 K5   | 79    | H303                               | H303G             |                     |  |         | H303                               | H303G   |                               |         |
| CR 80 RA/RB  | 80-81 | H304                               | H304G             |                     |  |         | H304                               | H304G   |                               |         |
| CR 80 RC   | 82    | H304                               | H304G             |                     |  |         | H333                               | H333G   |                               |         |
| CR 80 RD/RE  | 83-84 | H333                               | H333G             |                     |  |         | H333                               | H333G   |                               |         |
| CR 80 RF   | 85    | H333                               | H333G             |                     |  |         | H338                               | H338G   |                               |         |
| CR 80 R2F/R2G  | 85-86 | H304                               | H304G             |                     |  |         | H304                               | H304G   |                               |         |
| CR 80 RG/RH/RJ/RK/RL/RM                                    | 86-91 | FA84TT                             | FA84R■            | MD6004D             |  |         | H338                               | H338G   |                               |         |
| CR 80 RN/RP/RR/RS  | 92-95 | FA84TT                             | FA84R■            | MD6004D             |  |         | FA131TT                            | FA131R■ | MD6005D                       | MD6005C |
| CR 80 RT/RBT/RV/RBV/RW/RBW/RX<br>/RBX/RY/RBY/R1/RB1/R2/RB2 | 96-02 | FA84TT                             | FA84R■            | MD6058D✕            |  | MD6058C | FA131TT                            | FA131R■ | MD6005D                       | MD6005C |
| CRE 80   | 98-   | FA84TT                             | FA84R■            | MD6058D✕            |  | MD6058C | FA131TT                            | FA131R■ | MD6005D                       | MD6005C |
| CRF 80 F4/F5/F6/F7   | 04-07 | H333                               | H333G             |                     |  |         | H333                               | H333G   |                               |         |
| MB 80 (MB8)  | 80-   | FA83/2TT                           |                   |                     | N/A  |         | H304                               |         |                               |         |
| MBX 80 FWDD/FWDF   | 83-86 | FA54TT*                            | FA54HH*           | N/A                 | N/A  |         | H304                               |         |                               |         |
| MCX 80   | 82-   | FA83/2TT                           |                   | N/A                 |  |         | H304                               |         |                               |         |
| MTX 80 RFD/RFF   | 83-84 | H304                               | H304G             |                     |  |         | H304                               | H304G   |                               |         |
| NH 80 MD-D/MD-G  | 83-86 | H303                               |                   |                     |  |         | H302                               |         |                               |         |
| NH 80 Lead 80  | 85    | FA176                              |                   | N/A                 |  |         | H302                               |         |                               |         |
| NH 80 Lead 80 SS   | 85    | FA176                              |                   | N/A                 |  |         | H333                               |         |                               |         |
| NH 80 MDR  | 94-   | H303                               |                   |                     |  |         | H333                               |         |                               |         |
| NSR 80 J-2/K/L/N (HC06)                                    | 88-92 | FA86                               | FA86HH            |                     | TBA  |         | FA131TT                            |         | TBA                           |         |
| NSR 80 P/R/S (HC06)  | 93-   | FA197                              | FA197HH           |                     | TBA  |         | FA131TT                            |         | TBA                           |         |
| XR 80 Z/A/B  | 80-81 | H304                               | H304G             |                     |  |         | H304                               | H304G   |                               |         |
| XR 80 R  | 87-88 | H333                               | H333G             |                     |  |         | H333                               | H333G   |                               |         |
| CR 85 R3/RB3/R4/RB4/R5/RB5/R6/RB6/R7/RB7                   | 03-07 | FA84TT                             | FA84R■            | MD6058D✕            |  | MD6058C | FA131TT                            | FA131R■ | MD6005D                       | MD6005C |
| C 90 "All Models"  | 75-92 | H303                               |                   |                     |  |         | H303                               |         |                               |         |
| C 90 "All Models"  | 93-03 | H304                               |                   |                     |  |         | H304                               |         |                               |         |
| EZ 90 "Cub"  | 91-95 | H303                               |                   |                     |  |         | H303                               |         |                               |         |

\*-2 Sets Required. ■ - Also available in MX-S race compound, see page 8. ✕ - Oversize and Supermoto disc available - see page 301.

**SAFETY WARNING:- DO NOT USE HH PADS ON REAR UNLESS ALSO USED ON FRONT TO AVOID BRAKE IMBALANCE.**

R Suffix = High Durability Sintered Pad. HH Suffix = High Performance Sintered Pad. G Suffix = Grooved Shoe.  
D Suffix = Drilled Disc. C Suffix = Contoured Disc. LS Suffix = Left/Steel Disc. RS = Right/Steel Disc.

BRAKE APPLICATIONS

# JAPANESE Built Motorcycles

APPLICATIONS

BRAKE



HONDA contd.



|  |           | Front/Avant/Vorn                   |                   |                     | Frente/Anteriere                                     |         | Rear/Arrière/Hinten                |              | Posterior/Posteriore          |         |
|--|-----------|------------------------------------|-------------------|---------------------|--|---------|------------------------------------|--------------|-------------------------------|---------|
|  |           | ①                                  | ②                 | ③                   | ④  | ⑤       | ⑥                                  | ⑦            | ⑧                             | ⑨       |
|  |           | Sintered/HH Pads/<br>Grooved shoes | Left/Gauche/Links | Right/Droite/Rechts | Contour Rotor<br>Universal left<br>and right fitment |         | Sintered/HH Pads/<br>Grooved shoes |              | Contour Rotor<br>Rear fitment |         |
| Lead 90                                      | 88-       | FA131/3                            |                   | N/A                 |  |         | H336                               |              |                               |         |
| NH 90 M/P/R "Yuppy"                          | 91-94     | FA131/3                            |                   | TBA                 |  |         | H303                               |              |                               |         |
| SRX 90 "Shadow" T/W/X                        | 97-99     | FA131/3                            |                   | MD931D              |  |         | H303                               |              |                               |         |
| TRX 90 Fourtrax/Sportrax P/R/S/T/V/W/X/Y/1-6 | 93-06     | H303*                              | H303G*            |                     |  |         | H306                               | H306G        |                               |         |
| <b>TRX 90 EX</b>                             | <b>07</b> | <b>H303*</b>                       | <b>H303G*</b>     |                     |  |         | <b>H306</b>                        | <b>H306G</b> |                               |         |
| Astrea Supra NF 100                          | 99        | FA197                              | FA197HH           | N/A                 |  |         | H303                               |              |                               |         |
| Astrea Grand/Supra (Drum Model)              | 97-98     | H303                               |                   |                     |  |         | H303                               |              |                               |         |
| CB 100 N                                     | 78-80     | FA52                               |                   | N/A                 |  |         | H304                               |              |                               |         |
| CRF 100 F4/F5/F6/F7                          | 04-07     | H333                               | H333G             |                     |  |         | H333                               | H333G        |                               |         |
| H 100 A/SD/SG/SJ                             | 82-92     | H303                               |                   |                     |  |         | H303                               |              |                               |         |
| SCV 100-3/F5 Lead                            | 03-07     | H352                               |                   |                     |  |         | H352                               |              |                               |         |
| SH 100 T/W/X/Y/1 "Scoopy"                    | 96-01     | FA193                              | FA193HH           | MD918D              |  |         | H303                               |              |                               |         |
| SJ 100 T/W/W/X "Bali Ex"                     | 96-99     | FA256                              | FA256HH           | MD923D              |  |         | H303                               |              |                               |         |
| XL 100 "All models"                          | 78-82     | H304                               | H304G             |                     |  |         | H304                               | H304G        |                               |         |
| XR 100 RP/RR/RS/RT/RV/RW/RX/R/Y/R1-R3        | 93-03     | H333                               | H333G             |                     |  |         | H333                               | H333G        |                               |         |
| XR 100 M5 (HD13) Motard                      | 05        | FA197                              | FA197HH           |                     | TBA  |         | FA131TT                            |              | TBA                           |         |
| XZ 100 2 "APE-HC07"                          | 02        | H304                               |                   |                     |  |         | H304                               |              |                               |         |
| ATC 110 "All models"                         | 79-84     | None                               |                   |                     |  |         | H306                               | H306G        |                               |         |
| CT 110 K/M/P                                 | 89-93     | H303                               |                   |                     |  |         | H304                               |              |                               |         |
| CT 110 P                                     | 89-04     | H304                               | H304G             |                     |  |         | H304                               | H304G        |                               |         |
| CT 110 X                                     |           | H304                               |                   |                     |  |         | H352                               |              |                               |         |
| ANF 125-3/5/T5/6/7 "Innova"                  | 03-07     | FA375                              |                   | N/A                 |  |         | H353                               |              |                               |         |
| ATC 125 ME/MG                                | 84-85     | H303                               | H303G             |                     |  |         | H306                               | H306G        |                               |         |
| CA 125 S/T "Rebel"                           | 95-97     | FA228                              | FA228HH           | MD1030LS            |  |         | H318                               |              |                               |         |
| CA 125 V/W/X "Rebel"                         | 98-00     | FA256                              | FA256HH           | MD1030LS            |  |         | H318                               |              |                               |         |
| CB 125 K1-K5                                 | 72-76     | H308                               |                   |                     |  |         | H310                               |              |                               |         |
| CB 125 K6/S2                                 | 76        | N/A                                |                   |                     | N/A  |         | H310                               |              |                               |         |
| CB 125 S                                     | 75-79     | H303                               |                   |                     |  |         | H303                               |              |                               |         |
| CB 125 J                                     | 79        | FA40                               |                   | N/A                 |  |         | H304                               |              |                               |         |
| CB 125 T                                     | 78        | FA40                               |                   | N/A                 |  |         | H310                               |              |                               |         |
| CB 125 T2                                    | 79        | FA52                               |                   | N/A                 |  |         | H310                               |              |                               |         |
| CB 125 TDC/TDE/TDJ                           | 83-89     | FA69                               | FA69HH            | N/A                 |  |         | H310                               |              |                               |         |
| CB 125 RS                                    | 83        | FA54TT                             | FA54HH            |                     | N/A  |         | H310                               |              |                               |         |
| CBR 125 R4/R5/RS5/RW5/RS6/R7                 | 04-07     | FA375                              |                   |                     | MD644RS  |         | FA343                              |              | MD1151                        |         |
| CBX 125 TS Custom                            | 82-       | FA54TT                             | FA54HH            |                     | N/A  |         | H310                               |              |                               |         |
| CBX 125 F                                    | 84-       | FA69                               | FA69HH            | N/A                 |  |         | H318                               |              |                               |         |
| CBX 125 Custom                               | 88-       | FA86                               | FA86HH            | N/A                 |  |         | H304                               |              |                               |         |
| CD 125 TC                                    | 78        | H312                               |                   |                     |  |         | H310                               |              |                               |         |
| CG 125 K1/B/C/E                              | 77-84     | H303                               |                   |                     |  |         | H303                               |              |                               |         |
| CG 125 BR-K/BR-T/95                          | 85-97     | H330                               |                   |                     |  |         | H303                               |              |                               |         |
| CG 125 T/W/M/1/1                             | 98-03     | H330                               |                   |                     |  |         | H304                               |              |                               |         |
| CG 125-ES4                                   | 04-07     | FA54TT                             | FA54HH            |                     |  | N/A     | H352                               |              |                               |         |
| CG 125 Job                                   | 05        | H352                               |                   |                     |  |         | H353                               |              |                               |         |
| CH 125 D/E/G "Spacy"                         | 84-86     | H303                               |                   |                     |  |         | H303                               |              |                               |         |
| CH 125 J/K/L/M/P/R/T "Spacy"                 | 88-96     | H303                               |                   |                     |  |         | H303                               |              |                               |         |
| CLR 125 W "City Fly"                         | 99-03     | FA256                              | FA256HH           | MD1147LS            |  |         | H304                               |              |                               |         |
| CM 125 CC/CF                                 | 82-85     | H312                               |                   |                     |  |         | H310                               |              |                               |         |
| CR 125 M2-M4                                 | 76-78     | H304                               | H304G             |                     |  |         | H304                               | H304G        |                               |         |
| CR 125 RZ/RA/RB                              | 79-81     | H324                               | H324G             |                     |  |         | H330                               | H330G        |                               |         |
| CR 125 RC                                    | 82        | H319                               | H319G             |                     |  |         | H330                               | H330G        |                               |         |
| CR 125 RD                                    | 83        | H331                               | H331G             |                     |  |         | H331                               | H331G        |                               |         |
| CR 125 RE/RF                                 | 84-85     | FA92TT                             | FA92R             | MD6087D             |  |         | H331                               | H331G        |                               |         |
| CR 125 RG                                    | 86        | FA92TT                             | FA92R             | MD6087D             |  |         | H344                               | H344G        |                               |         |
| CR 125 RH/RJ                                 | 87-88     | FA125TT                            | FA125R            | MD6087D             |  |         | FA131TT                            | FA131R       | MD6009D                       |         |
| CR 125 RK                                    | 89        | FA125TT                            | FA125R            | MD6008D             |  |         | FA131TT                            | FA131R       | MD6002D                       |         |
| CR 125 RL/RM                                 | 90-91     | FA125TT                            | FA125R            | MD6003D             |  |         | FA131TT                            | FA131R       | MD6002D                       |         |
| CR 125 RN/RP/RR                              | 92-94     | FA125TT                            | FA125R            | MD6001D             |  | MD6001C | FA131TT                            | FA131R       | MD6002D                       |         |
| CR 125 RS/RT/RV                              | 95-97     | FA185TT                            | FA185R            | MD6037D             |  | MD6037C | FA131TT                            | FA131R       | MD6002D                       |         |
| CR 125 RW/RX/R/Y/R1                          | 98-01     | FA185TT                            | FA185R            | MD6037D             |  | MD6037C | FA131TT                            | FA131R       | MD6124D                       | MD6124C |
| CR 125 R2/R3                                 | 02-03     | FA185TT                            | FA185R            | MD6037D             |  | MD6037C | FA346TT                            | FA346R       | MD6191D                       | MD6191C |

\*-2 Sets Required. ■ - Also available in MX-S race compound, see page 8. ✖ - Oversize and Supermoto disc available - see page 301.

**SAFETY WARNING:- DO NOT USE HH PADS ON REAR UNLESS ALSO USED ON FRONT TO AVOID BRAKE IMBALANCE.**



# JAPANESE Built Motorcycles



| Front/Avant/Vorn                   |                   |                     | Frente/Anteriere                                     |                                    |                               | Rear/Arrière/Hinten |   |   | Posterior/Posteriore |  |  |
|------------------------------------|-------------------|---------------------|--|------------------------------------|-------------------------------|---------------------|---|---|----------------------|--|--|
| 1                                  | 2                 | 3                   | 4  | 5                                  | 6                             | 7                   | 8 | 9 |                      |  |  |
| Sintered/HH Pads/<br>Grooved shoes | Left/Gauche/Links | Right/Droite/Rechts | Contour Rotor<br>Universal left<br>and right fitment | Sintered/HH Pads/<br>Grooved shoes | Contour Rotor<br>Rear fitment |                     |   |   |                      |  |  |

HONDA contd.

|   |       |         |         |          |          |         |         |         |         |         |
|---|-------|---------|---------|----------|----------|---------|---------|---------|---------|---------|
| CR 125 R4/R5/R6/R7                        | 04-07 | FA185TT | FA185R■ | MD6037D✕ |          | MD6037C | FA346TT | FA346R■ | MD6191D | MD6191C |
| CRM 125 RL/RM/RP/RR/RV/RX                 | 90-99 | FA256TT | FA256HH | MD1147LS |          |         | FA47/3  |         | N/A     |         |
| CT 125 C                                  | 85    | H304    |         |          |          |         | H304    |         |         |         |
| FES 125 W/Y1/2 "Pantheon"                 | 98-02 | FA281   | FA261HH | MD922D   |          |         | H351    |         |         |         |
| FES 125 3/4/5/6/7 Pantheon                | 03-07 | FA281   | FA261HH | MD922D   |          |         | FA140   | FA140HH | MD1004  |         |
| FS 125 Sonic                              | 03-04 | FA86    | FA86HH  |          | N/A      |         | FA375   |         | N/A     |         |
| LS 125 RY                                 | 00-   | FA86    | FA86HH  |          | N/A      |         | FA197   |         | N/A     |         |
| MBX 125 FE                                | 84-86 | FA86    | FA86HH  |          | N/A      |         | H304    |         |         |         |
| MTX 125 RWD                               | 83-84 | H304    |         |          |          |         | H304    |         |         |         |
| MTX 125 RWE/RWF/RWH/RWL                   | 85-95 | FA92TT  | FA92R   | MD6087D  |          |         | H304    | H304G   |         |         |
| NES 125 Y1/2/3/4/5 (@ 125 Scooter)        | 00-05 | FA323   | FA323HH | MD970D   |          |         | H352    |         |         |         |
| NH 125 MD-D "Lead"                        | 83    | H303    |         |          |          |         | H303    |         |         |         |
| NH 125 Lead 125                           | 86-87 | FA176   |         | N/A      |          |         | H303    |         |         |         |
| NS 125 FG/FH/RH                           | 86-90 | FA256   | FA256HH | MD1084LS |          |         | H303    |         |         |         |
| NSR 125 FM/RR/RL/RM/RN                    | 91-92 | FA256   | FA256HH | MD1088LS |          |         | FA47/3  |         | N/A     |         |
| NSR 125 FP/RP/RR/RV/RW/RX/R1              | 93-04 | FA256   | FA256HH | MD1109LS |          |         | FA47/3  |         | N/A     |         |
| NX 125 K/S/F "Transcity"                  | 89-97 | FA256TT | FA256HH | MD1147LS |          |         | H303    |         |         |         |
| NXR 125 Bros ES/KS                        | 05    | H352    |         |          |          |         | H353    |         |         |         |
| PS 125 i6/i7                              | 06-07 | FA323   | FA323HH | MD920D   |          |         | H352    |         |         |         |
| SES 125 2/3/4 'Dylan'                     | 02-07 | FA323   | FA323HH | MD970D   |          |         | H352    |         |         |         |
| SH 125 1/3/4/5/6-i7-i                     | 01-07 | FA323   | FA323HH | MD970D   |          |         | H352    |         |         |         |
| SL 125 KIA                                | 76    | H303    |         |          |          |         | H303    |         |         |         |
| SL 125 KID/E/F/G/K2A                      | 76-80 | H304    |         |          |          |         | H304    |         |         |         |
| TL 125                                    | 76    | H304    | H304G   |          |          |         | H304    | H304G   |         |         |
| TRX 125 J                                 | 88    | H303*   | H303G*  |          |          |         | H306    | H306G   |         |         |
| VT 125 CX/CY/C2Y/C1/C21/C3/C4-C7 "Shadow" | 99-07 | FA197   | FA197HH |          | MD1030RS |         | H318    |         |         |         |
| XL 125 K2                                 | 78    | H304    | H304G   |          |          |         | H304    | H304G   |         |         |
| XL 125 K3/K4                              | 79    | H303    | H303G   |          |          |         | H304    | H304G   |         |         |
| XL 125 SZ/SA/SB/SC/RC                     | 79-82 | H304    | H304G   |          |          |         | H304    | H304G   |         |         |
| XL 125 Paris-Dakar                        | 85    | FA256TT | FA256HH | N/A      |          |         | H303    |         |         |         |
| XL 125 RF/RH                              | 85-86 | FA92TT  | FA92R   | MD6087D  |          |         | H304    | H304G   |         |         |
| XL 125 V1/V2/V3/V4/V5/V6/V7 "Varadero"    | 01-07 | FA197   | FA197HH |          | MD1150RS |         | FA343   |         | MD1151  |         |
| XLR 125 RW                                | 98-01 | FA185TT | FA185R■ | MD6001D  |          | MD6001C | H304    | H304G   |         |         |
| XR 125 L3/L4/L5/L6/L7                     | 03-07 | FA185TT | FA185R■ | N/A      |          |         | H304    | H304G   |         |         |
| CBR 150 R                                 | 00-03 | FA375   |         |          | MD644RS  |         | FA343   |         | MD1151  |         |
| CG 150 ESD Titan                          | 04-05 | FA54TT  | FA54R■  | N/A      |          |         | H352    |         |         |         |
| CG 150 KS/ES Titan                        | 04-05 | FA54TT  | FA54R■  | N/A      |          |         | H352    |         |         |         |
| CRF 150 F3/F4/F5/F6/F7                    | 03-06 | FA185TT | FA185R■ | MD6001D✕ |          | MD6001C | H304    | H304G   |         |         |
| CRF 150 RB7/R7                            | 07    | FA84TT  | FA84R■  | MD6058D✕ |          | MD6058C | FA346TT | FA346R■ | MD6005D | MD6005C |
| FES 150 W/Y1/2 'Pantheon'                 | 98-02 | FA281   |         | MD922D   |          |         | H351    |         |         |         |
| FES 150 3/4/5 Pantheon                    | 03-06 | FA281   |         | MD970D   |          |         | FA140   |         | MD1004  |         |
| NES 150 Y1/2/3/4/5 "@ 150 Scooter"        | 01-05 | FA323   |         | MD970D   |          |         | H352    |         |         |         |
| NSR 150 RR (Malaysian Market)             |       | FA197   | FA197HH | N/A      |          |         | FA197   | FA197HH | N/A     |         |
| SES 150 2/3/4 Dylan                       | 02-06 | FA323   | FA323HH | MD970D   |          |         | H352    |         |         |         |
| SH 150 1/3/4/5/i6/i7                      | 01-07 | FA323   | FA323HH | MD970D   |          |         | H352    |         |         |         |
| CB 175 "All models"                       | 74-76 | H308    |         |          |          |         | H309    |         |         |         |
| CD 175 "All models"                       | 71-78 | H306    |         |          |          |         | H307    |         |         |         |
| ATC 185 A/SB                              | 80-81 | H303    | H303G   |          |          |         | H306    | H306G   |         |         |
| CD 185 T                                  | 78    | H312    |         |          |          |         | H310    |         |         |         |
| XL 185 SZ/SA/SB                           | 80-82 | H304    | H304G   |          |          |         | H304    | H304G   |         |         |
| ATC 200 B/ESE/ESF/SE                      | 81-84 | H303    | H303G   |          |          |         | H306    | H306G   |         |         |
| ATC 200 XD                                | 83    | →       | FA84/2R | MD6059D  |          |         | →       | FA84/2R | MD6059D |         |
| TRX 200 L/M/DM/DN                         | 90-93 | H345*   | H345G*  |          |          |         | H306    | H306G   |         |         |
| CB 200 B                                  | 76-79 | N/A     |         | N/A      |          |         | H309    |         |         |         |
| CBX 200 Strada                            | 97-01 | FA54TT  | FA54HH  |          | N/A      |         | H352    |         |         |         |
| CD 200 TA/TB                              | 79-80 | H312    |         |          |          |         | H310    |         |         |         |
| CM 200 TA/TB                              | 79-80 | H312    |         |          |          |         | H310    |         |         |         |
| CTX 200/CTX 200 A Bushlander              | 04-05 | FA185TT | FA185R■ | MD6001D  |          | MD6001C | H304    | H304G   |         |         |
| MTX 200 RWD                               | 83-84 | H304    | H304G   |          |          |         | H304    | H304G   |         |         |
| MTX 200 RWF                               | 85    | FA92TT  | FA92R   | MD6087D  |          |         | H304    | H304G   |         |         |

\*-2 Sets Required. ■ - Also available in MX-S race compound, see page 8. ✕ - Oversize and Supermoto disc available - see page 301.

**SAFETY WARNING:- DO NOT USE HH PADS ON REAR UNLESS ALSO USED ON FRONT TO AVOID BRAKE IMBALANCE.**

R Suffix = High Durability Sintered Pad. HH Suffix = High Performance Sintered Pad. G Suffix = Grooved Shoe.  
D Suffix = Drilled Disc. C Suffix = Contoured Disc. LS Suffix = Left/Steel Disc. RS = Right/Steel Disc.

BRAKE APPLICATIONS

# JAPANESE Built Motorcycles

APPLICATIONS

BRAKE



| Front/Avant/Vorn               |                                | Frente/Anteriore  |                     |  | Rear/Arrière/Hinten            |                                | Posterior/Posteriore       |                            |
|--------------------------------|--------------------------------|-------------------|---------------------|--|--------------------------------|--------------------------------|----------------------------|----------------------------|
| 1                              | 2                              | 3                 | 4                   | 5  | 6                              | 7                              | 8                          | 9                          |
| Sintered/HH Pads/Grooved shoes | Sintered/HH Pads/Grooved shoes | Left/Gauche/Links | Right/Droite/Rechts | Contour Rotor Universal left and right fitment | Sintered/HH Pads/Grooved shoes | Sintered/HH Pads/Grooved shoes | Contour Rotor Rear fitment | Contour Rotor Rear fitment |

HONDA contd.

|  |       |         |           |          |          |         |         |         |         |         |
|--|-------|---------|-----------|----------|----------|---------|---------|---------|---------|---------|
| TA 200 (TA Shadow)                         | 02-05 | FA197   | FA197HH   | TBA      | TBA      |         | FA197   | FA197HH | N/A     |         |
| TL 200 J/Y "Colin Seeley"                  | 76-78 | H304    | H304G     |          |          |         | H304    | H304G   |         |         |
| TLR 200 D/E                                | 83-85 | H333    | H333G     |          |          |         | H333    | H333G   |         |         |
| TLR 200 G/H                                | 86-87 | H304    | H304G     |          |          |         | H333    | H333G   |         |         |
| XL 200 L                                   | 85    | FA256TT | FA256HH   | N/A      |          |         | H303    |         |         |         |
| XL 200 R                                   | 85    | FA92TT  | FA92R     | N/A      |          |         | H303    |         |         |         |
| XR 200                                     | 80-84 | H304    | H304G     |          |          |         | H304    | H304G   |         |         |
| XR 200 R                                   | 81-83 | H304    | H304G     |          |          |         | H304    | H304G   |         |         |
| XR 200 R                                   | 84-85 | H304    | H304G     |          |          |         | H304    | H304G   |         |         |
| XR 200 R                                   | 86-02 | H304    | H304G     |          |          |         | H304    | H304G   |         |         |
| FTR 223 Y/2/A2 (MC34)                      | 00-02 | FA92TT  | FA92R     | TBA      |          |         | H352    |         |         |         |
| CRF 230 F4/F5/F6/F7                        | 04-07 | FA185TT | FA185R■   | MD6001D* |          | MD6001C | H304    | H304G   |         |         |
| SL 230 "Free Landsports" (MD33) V/W/X/1    | 97-01 | FA185TT | FA185R■   | MD6001D  |          | MD6001C | FA131TT | FA131R■ | MD6013D | MD6013C |
| XL 230 2 (MC36)                            | 02    | H352    |           |          |          |         | H352    |         |         |         |
| ATC 250 RB                                 | 81    | FA54TT  | FA54R■    |          | MD6060D  |         | H306    | H306G   |         |         |
| ATC 250 RC                                 | 82    | FA84TT  | FA84R■    |          | MD6060D  |         | H306    | H306G   |         |         |
| ATC 250 RD                                 | 83-84 | FA84TT  | FA84R■    |          | MD6059D  |         | FA84TT  | FA84R■  | MD6059D |         |
| ATC 250 RF/RG                              | 85-86 | FA92TT  | FA92R     | MD6059D  |          |         | FA92TT  | FA92R   | MD6007D |         |
| ATC 250 ESF/ESG/ESH/ESJ                    | 85-88 | H306    | H306G     |          |          |         | H315    | H315G   |         |         |
| AX-1 (NX 250 J/K/R/R3)                     | 89-94 | FA125TT | FA125R■   | MD6001D  |          | MD6001C | FA153   |         | MD6198D |         |
| CB 250 K3-K5                               | 73-75 | H314    |           |          |          |         | H315    |         |         |         |
| CB 250 G5                                  | 75    | FA13    |           |          | N/A      |         | H315    |         |         |         |
| CB 250 T                                   | 78    | FA45    |           | N/A      |          |         | H313    |         |         |         |
| CB 250 N/NA/NB/NDB/NDC                     | 78-82 | FA45    |           | MD1036LS |          |         | H313    |         |         |         |
| CB 250 RSA/RSD                             | 81-84 | FA45    |           | N/A      |          |         | H309    |         |         |         |
| CB 250 FT/FV/FX/FY/F1 "Hornet"             | 96-01 | FA187   | FA187HH   |          | MD1144RS |         | FA140   | FA140HH | MD1004  | MD1004C |
| CB 250 N/T/W/X/Y/1/4 "Two Fifty"           | 92-05 | FA196   | FA196HH   | MD1089LS |          |         | H310    |         |         |         |
| CBF 250 4                                  | 04-06 | FA197   | FA197HH   |          | MD644RS  |         | H352    |         |         |         |
| CBR 250 FG/FGYA (MC14)                     | 86    | FA121*  | FA121HH*  | MD1006LS | MD1006RS |         | H309    |         |         |         |
| CBR 250 RH (MC17)                          | 87    | FA121*  | FA121HH*  | MD1006LS | MD1006RS |         | FA140   | FA140HH | MD1004  | MD1004C |
| CBR 250 RJ/RK/RK2 (MC19)                   | 88-89 | FA142   | FA142HH   |          | MD1140RS |         | FA140   | FA140HH | MD1004  | MD1004C |
| CBR 250 RRL/RRN/RRR (MC22)                 | 90-94 | FA142*  | FA142HH*  | MD1145LS | MD1145RS |         | FA140   | FA140HH | MD1004  | MD1004C |
| CBX 250 RSE                                | 84    | FA69    | FA69HH    | MD1090LS |          |         | H318    |         |         |         |
| CBX 250 Twister                            |       | TBA     |           |          |          |         | H352    |         |         |         |
| CBX 250                                    | 84-98 | FA86    | FA86HH    |          | MD1030RS |         | H304    |         |         |         |
| CD 250 UJ                                  | 88-92 | FA124/2 | FA124/2HH | MD1090LS |          |         | H310    |         |         |         |
| CH 250 F/G "Spacy"                         | 85-86 | FA323/2 |           | MD913D   |          |         | H341    |         |         |         |
| CJ 250 T                                   | 77    | FA13    |           | N/A      |          |         | H315    |         |         |         |
| C 250 SC                                   | 81    | H312    |           |          |          |         | H309    |         |         |         |
| CM 250 TB                                  | 81    | FA45    |           | MD1036LS |          |         | H313    |         |         |         |
| CMX 250 CT "Rebel" (Nissin Caliper)        | 96    | FA228   | FA228HH   | MD1030LS |          |         | H318    |         |         |         |
| CMX 250 CV/CW/CX "Rebel" (Grimeca Caliper) | 97-00 | FA256   | FA256HH   | MD1030LS |          |         | H318    |         |         |         |
| CN 250 H/J/K/L/M/P/R/S/T/V/X SPAZIO/Helix  | 87-98 | FA69/2  |           | MD908D   |          |         | H350    |         |         |         |
| CN 250 3 (MF02) Fusion/Fusion X            |       |         |           |          |          |         |         |         |         |         |
| /Fusion X Special                          | 03    | FA196   | FA196HH   | MD908D   |          |         | H350    |         |         |         |
| CR 250 RZ/RA                               | 79-80 | H324    | H324G     |          |          |         | H325    | H325G   |         |         |
| CR 250 RB/RC                               | 81-82 | H327    | H327G     |          |          |         | H330    | H330G   |         |         |
| CR 250 RD                                  | 83    | H328    | H328G     |          |          |         | H331    | H331G   |         |         |
| CR 250 RE/RF                               | 84-85 | FA92TT  | FA92R     | MD6087D  |          |         | H331    | H331G   |         |         |
| CR 250 RG                                  | 86    | FA92TT  | FA92R     | MD6087D  |          |         | H344    | H344G   |         |         |
| CR 250 RH/RJ                               | 87-88 | FA125TT | FA125R■   | MD6087D  |          |         | FA131TT | FA131R■ | MD6009D | MD6009C |
| CR 250 RK                                  | 89    | FA125TT | FA125R■   | MD6008D  |          |         | FA131TT | FA131R■ | MD6002D | MD6002C |
| CR 250 RL/RM                               | 90-91 | FA125TT | FA125R■   | MD6003D  |          |         | FA131TT | FA131R■ | MD6002D | MD6002C |
| CR 250 RN/RP/RR                            | 92-94 | FA125TT | FA125R■   | MD6001D* |          | MD6001C | FA131TT | FA131R■ | MD6002D | MD6002C |
| CR 250 RS/RT                               | 95-96 | FA185TT | FA185R■   | MD6037D* |          | MD6037C | FA131TT | FA131R■ | MD6002D | MD6002C |
| CR 250 RV/RW/RX/R/Y/R1                     | 97-01 | FA185TT | FA185R■   | MD6037D* |          | MD6037C | FA131TT | FA131R■ | MD6124D | MD6124C |
| CR 250 R2/R3                               | 02-03 | FA185TT | FA185R■   | MD6037D* |          | MD6037C | FA346TT | FA346R■ | MD6191D | MD6191C |
| CR 250 R4/R5/R6/R7                         | 04-07 | FA185TT | FA185R■   | MD6037D* |          | MD6037C | FA346TT | FA346R■ | MD6191D | MD6191C |
| CRF 250 R4/R5/R6/R7                        | 04-07 | FA185TT | FA185R■   | MD6037D* |          | MD6037C | FA346TT | FA346R■ | MD6191D | MD6191C |
| CRF 250 X4/X5/X6/X7                        | 04-07 | FA185TT | FA185R■   | MD6037D* |          | MD6037C | FA346TT | FA346R■ | MD6191D | MD6191C |

\*-2 Sets Required. ■ - Also available in MX-S race compound, see page 8. ✖ - Oversize and Supermoto disc available - see page 301.

**SAFETY WARNING:- DO NOT USE HH PADS ON REAR UNLESS ALSO USED ON FRONT TO AVOID BRAKE IMBALANCE.**

# JAPANESE Built Motorcycles



| Front/Avant/Vorn                   |                   |                     | Frente/Anteriores                                    |                                    |                               | Rear/Arrière/Hinten |   |   | Posterior/Posteriore |  |  |
|------------------------------------|-------------------|---------------------|--|------------------------------------|-------------------------------|---------------------|---|---|----------------------|--|--|
| 1                                  | 2                 | 3                   | 4  | 5                                  | 6                             | 7                   | 8 | 9 |                      |  |  |
| Sintered/HH Pads/<br>Grooved shoes | Left/Gauche/Links | Right/Droite/Rechts | Contour Rotor<br>Universal left<br>and right fitment | Sintered/HH Pads/<br>Grooved shoes | Contour Rotor<br>Rear fitment |                     |   |   |                      |  |  |

HONDA contd.

|  |       |          |           |          |          |         |          |         |         |         |
|--|-------|----------|-----------|----------|----------|---------|----------|---------|---------|---------|
| CRM 250 R (RK) MK1 MD24 (100001-1008385)                             | 89-90 | FA125TT  | FA125R■   | MD6087D  |          | FA153   |          | MD6165D |         |         |
| CRM 250 R (RM) MK2 MD24<br>(1200001-1211634)                         | 91-92 | FA125TT  | FA125R■   | MD6001D* |          | MD6001C | FA131TT  | FA131R■ | MD6013D | MD6013C |
| CRM 250 R (RP/RP-II) MK2/2 MD24<br>(1300001-)                        | 93    | FA125TT  | FA125R■   | MD6001D* |          | MD6001C | FA131TT  | FA131R■ | MD6013D | MD6013C |
| CRM 250 (MD24) 140 (MK3) RR-RR-II                                    | 94-96 | FA185TT  | FA185R■   | MD6001D* |          | MD6001C | FA131TT  | FA131R■ | MD6013D | MD6013C |
| CRM 250 ARV/ARW "Active Radical" (MD32)                              | 97-98 | FA185TT  | FA185R■   | MD6001D* |          | MD6001C | FA131TT  | FA131R■ | MD6013D | MD6013C |
| FES 250 W/X "Foresight"  | 98-99 | FA281    |           | MD922D   |          | H351    |          |         |         |         |
| FES 250 Y1/1/2/5 Foresight   | 00-05 | FA281    |           | MD922D   |          | FA140   |          | MD1004  |         |         |
| Note - Brake shoes (Parking)   |       | H351     |           |          |          |         |          |         |         |         |
| FL 250 Odyssey   | 77-84 | FA40     |           | N/A      |          | H306    | H306G    |         |         |         |
| GB 250 E/H "Clubman" (MC10 101-110)                                  | 84-87 | FA69/2   |           | TBA      |          | H318    |          |         |         |         |
| GB 250 J/L/P/S/V "Clubman" (MC 10-120-150)                           | 89-97 | FA124/2  | FA124/2HH | TBA      |          | H318    |          |         |         |         |
| MXV 250 F (MC92)   | 83-88 | FA80/2   |           |          |          | H315    |          |         |         |         |
| NS 250 FE (MCII)   | 84    | FA69/2*  |           | MD1006LS | MD1006RS | FA69/3  |          | MD1002  |         |         |
| NS 250 RE/RG (MCII)  | 84-86 | FA69/2*  |           | MD1006LS | MD1006RS | FA69/3  |          | MD1002  |         |         |
| NSR 250 RG (MC16)  | 86    | FA121*   | FA121HH*  | MD1129LS | MD1129RS | FA69/3  | FA69/3HH | MD1002  |         |         |
| NSR 250 R (R2J) RSP (R4J) R (RSK<br>/RSK-11) RSP (R6K/R6K-11) (MC18) | 88    | FA187*   | FA187HH*  | MD1117LS | MD1117RS | FA140   | FA140HH  | MD1002  |         |         |
| NSR 250 RL/RN/RSP (MC21)   | 95-   | FA187*   | FA187HH*  | MD1117LS | MD1117RS | FA140   | FA140HH  | MD1002  |         |         |
| NSR 250 RR/R2R (MC28)  | 94-   | FA187*   | FA187HH*  | MD1117LS | MD1117RS | FA143   |          | MD1111  |         |         |
| NSS 250 YIAY1/A1/A3/3 Forza/Forza-ST/S/T<br>/Jazz/Reflex (MF04/MF06) | 00-04 | FA281    |           | MD922D   |          | FA358   |          | MD1004  | MD1004C |         |
| NSS 250 EX5/EX6 Forza EX (ABS)<br>Parking brake                      | 05-06 | FA388    | FA388HH   | MD922D   |          | FA415   | FA415HH  | MD1020  |         |         |
| NSS 250 AX5/AX6 Forza Z (ABS)<br>Parking brake                       | 05-06 | FA388    | FA388HH   | MD922D   |          | FA415   | FA415HH  | MD1020  |         |         |
| NX 250 J/K (MD21)  | 87-90 | FA125TT  | FA125R■   | MD6008D  |          | H323    | H323G    |         |         |         |
| NX 250 2L/M/P/2P (MD25)  | 90-93 | FA125TT  | FA125R■   | MD6001D  | MD6001C  | H323    | H323G    |         |         |         |
| PS 250 5/6 Big Ruckus  | 05-06 | FA388    | FA388HH   | MD922D   |          | H351    |          |         |         |         |
| RTL 250 SG   | 86    | H304     | H304G     |          |          | H304    | H304G    |         |         |         |
| TL 250 K1  | 79    | H304     | H304G     |          |          | H304    | H304G    |         |         |         |
| TLR 250 F  | 85    | H304     | H304G     |          |          | H304    | H304G    |         |         |         |
| TLM 250 RJ   | 89    | H304     | H304G     |          |          | H304    | H304G    |         |         |         |
| TRX 250 F/G/H  | 85-87 | H339*    | H339G*    |          |          | H315    | H315G    |         |         |         |
| TRX 250 RG/RH  | 86-87 | FA125TT* | FA125R■   | MD6046D  | MD6046D  | FA92TT  | FA92R    | MD6007D |         |         |
| TRX 250 RJ/RK  | 88-89 | FA125TT* | FA125R■   | MD6006D  | MD6006D  | FA92TT  | FA92R    | MD6007D |         |         |
| TRX 250 VWV/XY1/TE2-7/TM2-7<br>"Re Con"/ES                           | 97-07 | H345*    | H345G*    |          |          | H340    | H340G    |         |         |         |
| TRX 250 EX1/2/3/4/5/6/7  | 01-07 | FA84TT*  | FA84R■    | MD6006D  | MD6006D  | H340    | H340G    |         |         |         |
| VT 250 FL "Spada/Castel"   | 88-90 | FA142    | FA142HH   |          | TBA      | FA140   | FA140HH  | MD1002  |         |         |
| XL 250 K3/K4   | 78-79 | H311     | H311G     |          |          | H312    | H312G    |         |         |         |
| XL 250 S/SZ/SA   | 78-81 | H312     | H312G     |          |          | H323    | H323G    |         |         |         |
| XL 250 SB  | 82    | H312     | H312G     |          |          | H318    | H318G    |         |         |         |
| XL 250 RE/RF   | 84-85 | H330     | H330G     |          |          | H323    | H323G    |         |         |         |
| XL 250 RC  | 82    | H330     | H330G     |          |          | H323    | H323G    |         |         |         |
| XL 250 RL  | 90    | FA125TT  | FA125R■   | MD6001D  | MD6001C  | FA131TT | FA131R■  | MD6013D | MD6013C |         |
| XL 250 Degree (MD26)   |       | FA185TT  | FA185R■   | MD6001D  | MD6001C  | H323    | H323G    |         |         |         |
| XR 250 SZ/SA   | 79-80 | H312     | H312G     |          |          | H323    | H323G    |         |         |         |
| XR 250 RB/RC/RD  | 81-83 | H327     | H327G     |          |          | H323    | H323G    |         |         |         |
| XR 250 RE/RF   | 84-85 | FA92TT   | FA92R     | MD6001D  | MD6001C  | H304    | H304G    |         |         |         |
| XR 250 RG/RH   | 86-87 | FA92TT   | FA92R     | MD6087D  |          | H304    | H304G    |         |         |         |
| XR 250 RJ/RK   | 88-89 | FA125TT  | FA125R■   | MD6087D  |          | H304    | H304G    |         |         |         |
| XR 250 RL  | 90    | FA125TT  | FA125R■   | MD6087D  |          | FA131TT | FA131R■  | MD6013D | MD6013C |         |
| XR 250 RM/RN/RP/RR/RS  | 91-95 | FA125TT  | FA125R■   | MD6001D* | MD6001C  | FA131TT | FA131R■  | MD6013D | MD6013C |         |
| XR 250 RT/RV/RW/RX/RY/R1/R2/R3/R4                                    | 96-04 | FA185TT  | FA185R■   | MD6001D* | MD6001C  | FA131TT | FA131R■  | MD6013D | MD6013C |         |
| XR 250 Y/3 (MD30)  | 00-03 | FA185TT  | FA185R■   | MD6001D  | MD6001C  | FA131TT | FA131R■  | MD6013D | MD6013C |         |
| XR 250 3/5 (MD30) Motard   | 03-05 | FA185TT  | FA185R■   | MD6001D  | MD6001C  | FA131TT | FA131R■  | MD6013D | MD6013C |         |
| XR 250 Tornado   | 05    | TBA      |           | TBA      |          | H352    |          |         |         |         |
| XR 250 III Y/3 Baja  | 00-03 | FA185TT  | FA185R■   | MD6001D  | MD6001C  | FA131TT | FA131R■  | MD6013D | MD6013C |         |

\*-2 Sets Required. ■ - Also available in MX-S race compound, see page 8. ✕ - Oversize and Supermoto disc available - see page 301.

**SAFETY WARNING:- DO NOT USE HH PADS ON REAR UNLESS ALSO USED ON FRONT TO AVOID BRAKE IMBALANCE.**

R Suffix = High Durability Sintered Pad. HH Suffix = High Performance Sintered Pad. G Suffix = Grooved Shoe.  
D Suffix = Drilled Disc. C Suffix = Contoured Disc. LS Suffix = Left/Steel Disc. RS = Right/Steel Disc.

BRAKE  
APPLICATIONS

# JAPANESE Built Motorcycles

APPLICATIONS

BRAKE



| Front/Avant/Vorn                   |                   | Frente/Anteriores   |  |                                    | Rear/Arrière/Hinten           |   | Posterior/Posteriore |   |
|------------------------------------|-------------------|---------------------|--|------------------------------------|-------------------------------|---|----------------------|---|
| 1                                  | 2                 | 3                   | 4  | 5                                  | 6                             | 7 | 8                    | 9 |
| Sintered/HH Pads/<br>Grooved shoes | Left/Gauche/Links | Right/Droite/Rechts | Contour Rotor<br>Universal left<br>and right fitment | Sintered/HH Pads/<br>Grooved shoes | Contour Rotor<br>Rear fitment |   |                      |   |

HONDA contd.

|   |         |         |           |          |          |          |          |         |         |         |
|---|---------|---------|-----------|----------|----------|----------|----------|---------|---------|---------|
| XLR 250 Baja MK1 RF/R2F/RH (MD22)             | FA92TT  | FA92R   | MD6001D   |          | MD6001C  | H323     | H323G    |         |         |         |
| XLR 250 Baja MK2 R3 (MD22)                    | FA185TT | FA185R■ | MD6001D   |          | MD6001C  | FA153    |          | MD6013D | MD6013C |         |
| XLR 250 R/R3J/RK/RL/R3L/R3M/RN (MD22)         | 88-90   | FA92TT  | FA92R     | MD6087D  |          | FA153    |          | MD6013D | MD6013C |         |
| XLR 250 RM/R3N/RP/RR/R3R (MD22)               | 91-     | FA185TT | FA185R■   | MD6001D  |          | MD6001C  | FA131TT  | FA131R■ | MD6013D | MD6013C |
| VT 250 FD                                     | 83      | FA80/2  |           | N/A      |          | H309     |          |         |         |         |
| VT 250 CR/CT/CV "Magna"                       | 95-97   | FA196   | FA196HH   | MD1021LS |          | H321     |          |         |         |         |
| VTR 250 W/Y/1-7 (MC33)                        | 98-07   | FA196   | FA196HH   |          | MD1144RS | FA140    | FA140HH  | MD1004  | MD1004C |         |
| VTZ 250 H/J/K                                 | 86-88   | FA124/2 | FA124/2HH |          | TBA      | H309     |          |         |         |         |
| SH 300i A7                                    | 07      | FA388   | FA388HH   | TBA      |          | FA415    | FA415HH  | TBA     |         |         |
| TRX 300 J/K/L/T/V/W/X/Y (2WD)                 | 88-00   | H345*   | H345G*    |          |          | H315     | H315G    |         |         |         |
| TRX 300 FW/J/K/L/T/V/W/X/Y (4WD)              | 88-00   | H347*   | H347G*    |          |          | H315     | H315G    |         |         |         |
| TRX 300 EX P/R/S/T/V/W/X/Y/1/2/3/4/5/6/7      | 93-07   | FA84TT* | FA84R■    | MD6006D  | MD6006D  | FA84TT   | FA84R■   | MD6064D |         |         |
| CB 350 K4                                     | 74      | H314    |           |          |          | H315     |          |         |         |         |
| CB 350 SG/SJ                                  | 86-90   | FA121*  | FA121HH*  | MD1005LS | MD1005RS | H313     |          |         |         |         |
| FL 350 R Odyssey                              | 85-87   | H339*   | H339G*    |          |          | FA111    | FA111R   | N/A     |         |         |
| TRX 350 G/H/J/K/L/M/N                         | 86-93   | H342*   | H342G*    |          |          | H343     | H343G    |         |         |         |
| TRX 350 Rancher ES 4x4/2x4 (FMY1/1/2/3)       |         |         |           |          |          |          |          |         |         |         |
| /Rancher 4x4 & 2x4 (FEY1/1/2/3)               | 00-03   | H347S*  | H347SG*   |          |          | H351     | H351G    |         |         |         |
| XR 350 RD                                     | 83      | H331    | H331G     |          |          | H304     | H304G    |         |         |         |
| XR 350 RE                                     | 84      | FA92TT  | FA92R     | MD6087D  |          | H304     | H304G    |         |         |         |
| CB 360 G5                                     | 75      | FA13    |           |          | N/A      | H315     |          |         |         |         |
| CJ 360 T                                      | 78      | FA13    |           | MD1034LS |          | H315     |          |         |         |         |
| CB-1 (CB 400 F)                               | 89-90   | FA142   | FA142HH   |          | MD1038RS | FA140    | FA140HH  | MD1020  |         |         |
| CB 400 SF (F2N/F2R/F2S/F2T/F3S) "Superfour"   | 92-95   | FA142*  | FA142HH*  | MD1132LS | MD1132RS | MD1132C* | FA140    | FA140HH | MD1020  |         |
| CB 400 SF (F2V/F3T) "Superfour"               | 96-97   | FA187*  | FA187HH*  | MD1132LS | MD1132RS | MD1132C* | FA140    | FA140HH | MD1020  |         |
| CB 400 SF (F3V) "Superfour"                   | 97      | FA244*  | FA244HH*  | MD1132LS | MD1132RS | MD1132C* | FA140    | FA140HH | MD1020  |         |
| CB 400 F/F1/F2                                | 75-79   | FA13    |           | MD1034LS |          | H315     |          |         |         |         |
| CB 400 A "Honda-Matic"                        | 79      | FA45    |           | N/A      |          | H313     |          |         |         |         |
| CB 400 T                                      | 78      | FA45    |           | N/A      |          | H313     |          |         |         |         |
| CB 400 N/NA/NB                                | 78-81   | FA30*   |           | N/A      | N/A      | H313     |          |         |         |         |
| CB 400 NC                                     | 82      | FA69/2* |           | N/A      | N/A      | H313     |          |         |         |         |
| CB 400 Four V/V-II/W/W-II (NC36)              | 97-98   | FA142*  | FA142HH*  | TBA      | TBA      | FA140    | FA140HH  | MD1020  |         |         |
| CB 400 SFX/SFY/SF1/SF2/SF3                    |         |         |           |          |          |          |          |         |         |         |
| Super Four (NC39)                             | 99-03   |         | FA296HH*  | TBA      | TBA      | FA254    | FA254HH  | TBA     |         |         |
| CB 400 SBS                                    | 05      |         | FA296HH*  | TBA      | TBA      | FA174    | FA174HH  | TBA     |         |         |
| CB 400 SF4/5/S5                               | 04-05   |         | FA296HH*  | TBA      | TBA      | FA174    | FA174HH  | TBA     |         |         |
| CBR 400 RG (NC23) 100                         | 86      | FA121*  | FA121HH*  | MD1001LS | MD1001RS | FA69/3   | FA69/3HH | MD1002  |         |         |
| CBR 400 RH-YA (NC23) 101                      | 86      | FA121*  | FA121HH*  | MD1001LS | MD1001RS | FA69/3   | FA69/3HH | MD1002  |         |         |
| CBR 400 RRL/RRK (NC23) "Tri-Arm" (102/109)    | 87-89   | FA142*  | FA142HH*  | MD1003LS | MD1003RS | MD1003C* | FA140    | FA140HH | MD1002  |         |
| CBR 400 RRL/RRN/RRR (NC29) "Gull Arm"         | 90-94   | FA142*  | FA142HH*  | MD1003LS | MD1003RS | MD1003C* | FA140    | FA140HH | MD1004  |         |
| FJS 400 A (NF01) Silverwing                   | 01-02   | FA281   | FA261HH   | MD1006LS |          | FA196    | FA196HH  | MD1149  |         |         |
| Parking brake:                                |         | FA257/2 |           |          |          |          |          |         |         |         |
| FJS 400 D6 Silverwing                         | 06      | FA281   | FA261HH   | MD1006LS |          | FA196    | FA196HH  | MD1149  |         |         |
| Parking brake                                 |         | FA257/2 |           |          |          |          |          |         |         |         |
| FL 400 R RK/RL "Pilot"                        | 89-93   | H339*   | H339G*    |          |          | FA111    | FA111R   | MD6144D |         |         |
| NS 400 RF/RG                                  | 85-87   | FA69*   | FA69HH*   | MD1006LS | MD1006RS | FA69     | FA69HH   | MD1002  |         |         |
| NT 400 "Bros" (NC25)                          |         | FA187   | FA187HH   | MD1124LS |          | FA140    | FA140HH  | MD1022  |         |         |
| NV 400 C/J/CK "Steed"                         | 92-93   | FA124/2 | FA124/2HH | MD1047LS |          | H321     |          |         |         |         |
| NV 400 CS/CV "Steed"                          | 95-97   | FA142   | FA142HH   | MD1047LS |          | H321     |          |         |         |         |
| NV 400 DCY/DC1/DC2 (NC40) "Shadow Slasher"    | 00-02   | FA196   | FA196HH   | MD1008LS |          | H343     |          |         |         |         |
| NX 4 Falcon                                   | 02-05   | FA185TT | FA185R■   | TBA      |          | FA131TT  | FA131R■  | TBA     |         |         |
| RVF 400 RR/RR-II/RT/RT-II (NC35)              | 94-96   | FA187*  | FA187HH*  | MD1003LS | MD1003RS | MD1003C* | FA143    |         | MD1111  |         |
| TRX 400 FWS/T/V/W/X/Y                         | 95-00   | H347*   | H347G*    |          |          | H351     | H351G    |         |         |         |
| TRX 400 EXX/EXY/EX1-EX6                       | 99-06   | FA84TT* | FA84R*    | MD6006D  | MD6006D  | FA84TT   | FA84R    | MD6164D |         |         |
| TRX 400 FA4/5/6/7 Fourtrax AT                 | 04-07   | H347*   | H347G*    |          |          | H351     | H351G    |         |         |         |
| TRX 400 FGA4/5/6/7 Fourtrax Rancher at Gscape | 04-07   | H347*   | H347G*    |          |          | H351     | H351G    |         |         |         |
| VF 400 FD                                     | 83-85   | FA80/2  |           | N/A      |          | FA80/2   |          | N/A     |         |         |
| VFR 400 ZG/ZHRG/RG-YA (NC21)                  | 85-87   | FA121*  | FA121HH*  | MD1006LS | MD1006RS | FA69/3   | FA69/3HH | MD1002  |         |         |
| VFR 400 RH2/RJ (NC24)                         | 87-88   | FA121*  | FA121HH*  | MD1001LS | MD1001RS | FA140    | FA140HH  | MD1022  |         |         |
| VFR 400 R3K/R3N (NC30)                        | 89-92   | FA187*  | FA187HH*  | MD1003LS | MD1003RS | MD1003C* | FA143    |         | MD1111  |         |

\*-2 Sets Required. ■ - Also available in MX-S race compound, see page 8. ✖ - Oversize and Supermoto disc available - see page 301.

**SAFETY WARNING:- DO NOT USE HH PADS ON REAR UNLESS ALSO USED ON FRONT TO AVOID BRAKE IMBALANCE.**

# JAPANESE Built Motorcycles



HONDA contd.

|   |       | Front/Avant/Vorn               |                   |                     | Frente/Anteriores                              |          | Rear/Arrière/Hinten            |          | Posterior/Posteriore       |         |
|---|-------|--------------------------------|-------------------|---------------------|--|----------|--------------------------------|----------|----------------------------|---------|
|   |       | 1                              | 2                 | 3                   | 4  | 5        | 6                              | 7        | 8                          | 9       |
|   |       | Sintered/HH Pads/Grooved shoes | Left/Gauche/Links | Right/Droite/Rechts | Contour Rotor Universal left and right fitment |          | Sintered/HH Pads/Grooved shoes |          | Contour Rotor Rear fitment |         |
| VFR 400 R3L/R3M (NC30)                              | 90-91 | FA187*                         | FA187HH*          | MD1003LS            | MD1003RS                                       | MD1003C* | FA143                          |          | MD1111                     |         |
| VRX 400 T (NC33)                                    | 96    | FA196                          | FA196HH           |                     | TBA  |          | FA174                          | FA174HH  | TBA                        |         |
| XR 400 RT/RV/RW/RX/RY/R1/R2/R3/R4                   | 96-04 | FA185TT                        | FA185R■           | MD6001D*            |  | MD6001C  | FA131TT                        | FA131R■  | MD6013D                    |         |
| XR 400 R5/R6 (NC38E) Nomad                          | 05-06 | FA185TT                        | FA185R■           | TBA                 |  |          | FA131TT                        | FA131R■  | TBA                        |         |
| TRX 420 FE7/TE7 Fourtrax Rancher                    | 07    | FA84TT*                        | FA84R*            | MD6302D             | MD6302D  |          | H351                           | H351G    |                            |         |
| TRX 420 FM7/TM7 Fourtrax Rancher                    | 07    | FA84TT*                        | FA84R*            | MD6302D             | MD6302D  |          | H351                           | H351G    |                            |         |
| CB 450 SG/SJ  | 86-88 | FA121*                         | FA121HH*          | MD1005LS            | MD1005RS                                       |          | H321                           |          |                            |         |
| CB 450 DX-K   | 89-92 | FA122*                         |                   | N/A                 | N/A  |          | FA122                          |          | N/A                        |         |
| CMX 450 CH/CJ "Rebel"                               | 87-88 | FA69                           | FA69HH            | MD1041LS            |  |          | H313                           |          |                            |         |
| CR 450 RB   | 81    | H327                           | H327G             |                     |  |          | H319                           | H319G    |                            |         |
| CRF 450 R2/R3                                       | 02-03 | FA185TT                        | FA185R■           | MD6037D*            |  | MD6037C  | FA346TT                        | FA346R■  | MD6191D                    | MD6191C |
| CRF 450 R4/R5/R6/R7                                 | 04-07 | FA185TT                        | FA185R■           | MD6037D*            |  | MD6037C  | FA346TT                        | FA346R■  | MD6191D                    | MD6191C |
| CRF 450 X5/X6/X7                                    | 05-07 | FA185TT                        | FA185R■           | MD6037D*            |  | MD6037C  | FA346TT                        | FA346R■  | MD6191D                    | MD6191C |
| TRX 450 ESW/ESX/ESY/ES1                             | 98-01 | H347S*                         | H347SG*           |                     |  |          | H351                           | H351G    |                            |         |
| TRX 450 R4/R5/R6/ER6/R7/ER7                         | 04-07 | FA185TT*                       | FA185R■           | MD6006D             | MD6006D  |          |                                | FA373R   | MD6233D                    |         |
| CR 480 RC   | 82    | H327                           | H327G             |                     |  |          | H330                           | H330G    |                            |         |
| CR 480 RD   | 83    | H328                           | H328G             |                     |  |          | H331                           | H331G    |                            |         |
| CB 500 T  | 75-77 | FA13                           |                   | N/A                 |  |          | H316                           |          |                            |         |
| CB 500 K1/K2/F                                      | 75-77 | FA13                           |                   | MD1042LS            |  |          | H316                           |          |                            |         |
| CB 500 R/T  | 94-96 | FA196                          | FA196HH           |                     | MD1008RS                                       |          | H321                           |          |                            |         |
| CB 500 V/W/SW/X/SX/YY/S2/S2                         | 97-03 | FA209/2                        | FA209/2HH         |                     | MD1008RS                                       |          | FA213                          | FA213HH  | MD1020                     |         |
| CBF 500 A4/A5/A6/A7 (ABS Model)                     | 04-07 | FA388                          | FA388HH           |                     | MD1155RS                                       |          | FA174                          | FA174HH  | MD1156                     |         |
| CBF 500 4 (Non ABS Model)                           | 04    | FA196                          | FA196HH           |                     | MD1155RS                                       |          | FA174                          | FA174HH  | MD1156                     |         |
| CBR 500 FH/FJ/FK/FL                                 | 87-90 | FA121*                         | FA121HH*          | MD1001LS            | MD1001RS                                       |          | FA69/3                         | FA69/3HH | MD1002                     |         |
| CR 500 RE/RF  | 84-85 | FA92TT                         | FA92R             | MD6087D             |  |          | H331                           | H331G    |                            |         |
| CR 500 RG   | 86    | FA92TT                         | FA92R             | MD6087D             |  |          | H344                           | H344G    |                            |         |
| CR 500 RH/RJ  | 87-88 | FA125TT                        | FA125R■           | MD6087D             |  |          | FA131TT                        | FA131R■  | MD6009D                    |         |
| CR 500 RK   | 89    | FA125TT                        | FA125R■           | MD6008D             |  |          | FA131TT                        | FA131R■  | MD6002D                    |         |
| CR 500 RL/RM  | 90-91 | FA125TT                        | FA125R■           | MD6003D             |  |          | FA131TT                        | FA131R■  | MD6002D                    |         |
| CR 500 RN/RP/RR                                     | 92-94 | FA125TT                        | FA125R■           | MD6001D*            |  | MD6001C  | FA131TT                        | FA131R■  | MD6002D                    |         |
| CR 500 RS/RT/RV/RW/RX/RY/R1                         | 95-01 | FA185TT                        | FA185R■           | MD6037D*            |  | MD6037C  | FA131TT                        | FA131R■  | MD6002D                    |         |
| CX 500 CA/CB/Z/A/B                                  | 79-81 | FA29*                          |                   | N/A                 | N/A  |          | H321                           |          |                            |         |
| CX 500 CC   | 82    | FA69*                          | FA69HH*           | N/A                 | N/A  |          | H321                           |          |                            |         |
| CX 500 EC   | 82    | FA69*                          | FA69HH*           | MD1036LS            | MD1036RS                                       |          | FA69                           | FA69HH   | N/A                        |         |
| FT 500 C  | 82    | FA69                           | FA69HH            | MD1131LS            |  |          | FA69                           | FA69HH   | MD1048                     |         |
| GL 500 DC   | 82    | FA69                           | FA69HH            | N/A                 | N/A  |          | H321                           |          |                            |         |
| CX 500 TCC "Turbo"                                  | 83    | FA69*                          | FA69HH*           | N/A                 | N/A  |          | FA69                           | FA69HH   | N/A                        |         |
| NX 500 J/K/L/M "Dominator"                          | 88-91 | FA124/2                        | FA124/2HH         | MD6010D             |  |          | FA140                          | FA140HH  | MD6013D                    |         |
| NX 500 N/P/R/S/T                                    | 92-96 | FA124/2                        | FA124/2HH         | MD6010D             |  |          | FA140                          | FA140HH  | MD6099D                    |         |
| NX 500 V/W/X Dominator                              | 97-99 | FA209/2                        | FA209/2HH         | MD6010D             |  |          | FA213                          | FA213HH  | MD6099D                    |         |
| TRX 500 FA1/FA2/FA3/FA4 Fourtrax Rubicon            | 01-04 | H347S*                         | H347SG*           |                     |  |          | H343                           | H343G    |                            |         |
| TRX 500 FA5/FA6                                     | 05-07 | FA410TT*                       | FA410R*           | MD6251D             | MD6251D  |          | H343                           | H343G    |                            |         |
| TRX 500 FGA5/6/7 Fourtrax Foreman                   |       |                                |                   |                     |  |          |                                |          |                            |         |
| Rubicon Gpscape                                     | 05-07 | FA410TT*                       | FA410R*           | MD6251D             | MD6251D  |          | H343                           | H343G    |                            |         |
| VF 500 FE/F2E/FF/F2F                                | 84-85 | FA69*                          | FA69HH*           | MD1006LS            | MD1006RS                                       |          | FA69                           | FA69HH   | MD1006                     |         |
| VT 500 ED/EF  | 83-85 | FA80/2                         |                   | N/A                 |  |          | H313                           |          |                            |         |
| XL 500 SZ   | 80    | H312                           | H312G             |                     |  |          | H318                           | H318G    |                            |         |
| XL 500 SB   | 81    | H325                           | H325G             |                     |  |          | H309                           |          |                            |         |
| XL 500 RC   | 82    | H332                           | H332G             |                     |  |          | H318                           | H318G    |                            |         |
| XR 500 SZ/SA  | 79-80 | H324                           | H324G             |                     |  |          | H318                           | H318G    |                            |         |
| XR 500 RB   | 81    | H327                           | H327G             |                     |  |          | H318                           | H318G    |                            |         |
| XR 500 RD/RE  | 84-85 | FA92TT                         | FA92R             | MD6001D             |  |          | H304                           | H304G    |                            |         |
| XBR 500 F/G/H/SJ                                    | 85-89 | FA69                           | FA69HH            | MD1001LS            |  |          | H340                           |          |                            |         |
| CB 550 F/F1/F2/K3                                   | 78-80 | FA13                           |                   | MD1042LS            |  |          | H316                           |          |                            |         |
| CBX 550 FC/F2C/FD/F2D                               | 82-84 | FA80*                          |                   | N/A                 | N/A  |          | FA80/2                         |          | N/A                        |         |
| 600 Silverwing "Scooter" FJS 600 1/2/A3/D3/A4/D4/A5 |       |                                |                   |                     |  |          |                                |          |                            |         |
| /D5/A6/D6/A7 (inc ABS models)                       | 01-07 | FA281                          | FA261HH           | MD1006LS            |  |          | FA196                          | FA196HH  | MD1149                     |         |
| Parking brake pad                                   |       | FA257/2                        |                   |                     |  |          |                                |          |                            |         |
| CB 600 FW/FX "Hornet" (16" wheel)                   | 98-99 | FA226*                         | FA226HH*          | MD1132LS            | MD1132RS                                       | MD1132C* | FA174                          | FA174HH  | MD1004                     | MD1004C |

\*-2 Sets Required. ■ - Also available in MX-S race compound, see page 8. ✖ - Oversize and Supermoto disc available - see page 301.

**SAFETY WARNING:- DO NOT USE HH PADS ON REAR UNLESS ALSO USED ON FRONT TO AVOID BRAKE IMBALANCE.**

R Suffix = High Durability Sintered Pad. HH Suffix = High Performance Sintered Pad. G Suffix = Grooved Shoe.  
D Suffix = Drilled Disc. C Suffix = Contoured Disc. LS Suffix = Left/Steel Disc. RS = Right/Steel Disc.

BRAKE APPLICATIONS

# JAPANESE Built Motorcycles

APPLICATIONS

BRAKE



| Front/Avant/Vorn                   |                   | Frente/Anteriores   |  |  | Rear/Arrière/Hinten           |   | Posterior/Posteriore |   |
|------------------------------------|-------------------|---------------------|--|--|-------------------------------|---|----------------------|---|
| 1                                  | 2                 | 3                   | 4  | 5                                      | 6                             | 7 | 8                    | 9 |
| Sintered/HH Pads/<br>Grooved shoes | Left/Gauche/Links | Right/Droite/Rechts | Contour Rotor<br>Universal left<br>and right fitment | Sintered/<br>HH Pads/<br>Grooved shoes | Contour Rotor<br>Rear fitment |   |                      |   |

HONDA contd.

|  |       |          |            |          |          |          |         |          |         |         |
|--|-------|----------|------------|----------|----------|----------|---------|----------|---------|---------|
| CB 600 FY/F1/F2/F3/F4/F5/F6 "Hornet" (17" wheel) | 00-06 | FA226*   | FA226HH*   | MD1139LS | MD1139RS | MD1139C* | FA174   | FA174HH  | MD1004  | MD1004C |
| CB 600 F7 Hornet                                 | 07    | FA226*   | FA226HH*   | MD1141LS | MD1141RS | MD1141C* | FA436   | FA436HH  | MD1156  |         |
| CB 600 AF7 Hornet (ABS)                          | 07    | FA388*   | FA388HH*   | MD1141LS | MD1141RS | MD1141C* | FA174   | FA174HH  | MD1156  |         |
| CB 600 F2Y/F21/F22 Hornet S (17 wheel)           | 00-04 | FA226*   | FA226HH*   | MD1139LS | MD1139RS | MD1139C* | FA174   | FA174HH  | MD1004  | MD1004C |
| CBF 600 N4/S4/N5/N6                              | 04-06 | FA226*   | FA226HH*   | TBA      | TBA      |          | FA174   | FA174HH  | MD1156  |         |
| CBF 600 NA4/NA5/NA6 (ABS Model)                  | 04-06 | FA226*   | FA226HH*   | TBA      | TBA      |          | FA174   | FA174HH  | MD1156  |         |
| CBF 600 N7 (Radical Caliper)                     | 07    |          | FA390HH*   | TBA      | TBA      |          | FA174   | FA174HH  | TBA     |         |
| CBF 600 S4/S5 (Non ABS)                          | 04-05 | FA226*   | FA226HH*   | TBA      | TBA      |          | FA174   | FA174HH  | MD1156  |         |
| CBF 600 SA4/SA5/SA6/SA7 (ABS Model)              | 04-07 | FA226*   | FA226HH*   | TBA      | TBA      |          | FA174   | FA174HH  | MD1156  |         |
| CBR 600 FH/FJ/FK/FL                              | 87-90 | FA121*   | FA121HH*   | MD1001LS | MD1001RS |          | FA69/3  | FA69/3HH | MD1002  |         |
| CBR 600 FM/FN/FP/FR                              | 91-94 | FA203*   | FA203HH*   | MD1001LS | MD1001RS |          | FA174   | FA174HH  | MD1004  | MD1004C |
| oversize disc conversion for above models        |       | FA203*   | FA203HH*   | MD601LS  | MD601RS  |          |         |          |         |         |
| CBR 600 FS/FT/FV/FW                              | 95-98 | FA226*   | FA226HH*   | MD1003LS | MD1003RS | MD1003C* | FA174   | FA174HH  | MD1004  | MD1004C |
| CBR 600 FX/FY                                    | 99-00 | →        | FA296HH*   | MD1014LS | MD1014RS | MD1014C* | FA174   | FA174HH  | MD1004  | MD1004C |
| CBR 600 F1/F2/600 FS1/FS2 "Sport"                | 01-02 | →        | FA296HH*   | MD1141LS | MD1141RS | MD1141C* | FA174   | FA174HH  | MD1004  | MD1004C |
| CBR 600 F3/F4/F5/F6/F7                           | 03-07 | →        | FA296HH*   | MD1141LS | MD1141RS | MD1141C* | FA174   | FA174HH  | MD1004  | MD1004C |
| CBR 600 RR3/RR4                                  | 03-04 | →        | FA296HH*   | MD1152LS | MD1152RS | MD1152C* | FA174   | FA174HH  | MD1004  | MD1004C |
| CBR 600 RR5/RR6 (Radial Caliper)                 | 05-06 | →        | FA390HH*   | MD1152LS | MD1152RS | MD1152C* | FA174   | FA174HH  | MD1004  | MD1004C |
| CBR 600 RR7                                      | 07    |          | FA390HH*   | MD1152LS | MD1152RS | MD1152C* | FA436   | FA436HH  | MD1004  | MD1004C |
| NTV 600 J/K/M "Revere"                           | 88-92 | FA142    | FA142HH    | MD1021LS |          |          | FA140   | FA140HH  | MD1025  |         |
| VT 600 CN "Shadow custom"                        | 93    | FA124/2  | FA124/2HH  | MD1047LS |          |          | H321    |          |         |         |
| VT 600 CR/CS/CT/CV/CW/CX "Shadow custom"         | 94-00 | FA142    | FA142HH    | MD1047LS |          |          | H321    |          |         |         |
| XL 600 RD/LD/RE/LE/RF/RG/RH                      | 83-87 | FA92TT   | FA92R      | MD6087D  |          |          | H318    | H318G    |         |         |
| XL 600 LMF                                       | 85    | FA92TT   | FA92R      | MD6096D  |          |          | H318    | H318G    |         |         |
| XL 600 VH/VJ/VK "Trans Alp"                      | 87-90 | FA69     | FA69HH     | MD6044D  |          |          | H318    | H318G    |         |         |
| XL 600 VM/VN/VP "Trans Alp"                      | 91-93 | FA124/2  | FA124/2HH  | MD6044D  |          |          | FA140   | FA140HH  | MD6097D |         |
| XL 600 VR/VT "Transalp"                          | 94-96 | FA196    | FA196HH    | MD6044D  |          |          | FA140   | FA140HH  | MD6097D |         |
| XL 600 VV/VW/VX "Transalp"                       | 97-99 | FA185TT* | FA185R*■   | MD6010D  | MD6010DR |          | FA140   | FA140HH  | MD6097D |         |
| XR 600 RF/RG/RH                                  | 85-87 | FA92TT   | FA92R      | MD6087D  |          |          | H304    | H304G    |         |         |
| XR 600 RJ/RK/RL                                  | 88-90 | FA125TT  | FA125R■    | MD6087D  |          |          | H304    | H304G    |         |         |
| XR 600 RM  | 91    | FA125TT  | FA125R■    | MD6001Dx |          | MD6001C  | FA131TT | FA131R■  | MD6013D | MD6013C |
| XR 600 RP/RR/RS/RT/RV/RW/RX/RY                   | 93-00 | FA185TT  | FA185R■    | MD6001Dx |          | MD6001C  | FA131TT | FA131R■  | MD6013D | MD6013C |
| CB 650 Z/B                                       | 79-81 | FA45*    |            | N/A      | N/A      |          | H320    |          |         |         |
| CB 650 SCC "Nighthawk"                           | 82    | FA90*    |            | MD1036LS | MD1036RS |          | H320    |          |         |         |
| CX 650 ED  | 83    | FA69/2*  |            | MD1036LS | MD1036RS |          | FA69    |          | N/A     |         |
| CX 650 TD "Turbo"                                | 83    | FA69/2*  |            | MD1115LS | MD1115RS |          | FA69    |          | N/A     |         |
| FMX 650 5/6                                      | 05-07 | FA196    | FA196HH    | MD6300D  |          |          | FA140   | FA140HH  | MD6165D |         |
| FX 650 X/Y "Vigor"                               | 99-03 | FA209/2  | FA209/2HH  | MD6044D  |          |          | FA208TT |          | MD6099D |         |
| GL 650 D2-E                                      | 84    | FA69/2*  |            | MD1040LS | MD1040RS |          | H321    |          |         |         |
| NT 650 J/K/L (Bros)                              | 88-92 | FA187    | FA187HH    | MD1124LS |          |          | FA140   | FA140HH  | MD1022  |         |
| NT 650 VV/VX/VY/V1 "Deauville"                   | 98-01 | FA209/2* | FA209/2HH* | MD1008LS | MD1008RS |          | FA140   | FA140HH  | MD1001  |         |
| NT 650 V2/V3/V4 Deauville ③                      | 02-04 | →        | FA261HH*   | MD1008LS | MD1008RS |          |         | FA261HH  | MD1001  |         |
| NTV 650 J/K/L/M/P/S/T/V                          | 88-97 | FA142    | FA142HH    | MD1021LS |          |          | FA140   | FA140HH  | MD1025  |         |
| NX 650 J/K/L/LI/M "Dominator"                    | 88-91 | FA124/2  | FA124/2HH  | MD6010D  |          |          | FA140   | FA140HH  | MD6013D | MD6013C |
| NX 650 N/P/R/S/T "Dominator"                     | 92-96 | FA124/2  | FA124/2HH  | MD6010D  |          |          | FA140   | FA140HH  | MD6099D |         |
| NX 650 V/W/X "Dominator"                         | 97-02 | FA209/2  | FA209/2HH  | MD6010D  |          |          | FA213   | FA213HH  | MD6099D |         |
| SLR 650 V/W                                      | 97-98 | FA209/2  | FA209/2HH  | MD6044D  |          |          | FA213   | FA213HH  | MD6099D |         |
| TRX 650 FA3/FA4/FA5 'Rincon'                     | 03-05 | H347*    | H347G*     |          |          |          |         | FA373R   | MD6217D |         |
| XL 650 VY/V1-V7 Transalp                         | 00-07 | FA185TT* | FA185R*■   | MD6010D  | MD6010DR |          | FA140   |          | MD6097D |         |
| XR 650 RY/R1-R7                                  | 00-07 | FA185TT  | FA185R■    | MD6001Dx |          | MD6001C  | FA131TT | FA131R■  | MD6181D |         |
| XRV 650 J/K Africa Twin                          | 88-89 | FA124/2  | FA124/2HH  | MD6168D  |          |          | FA140   | FA140HH  | MD6097D |         |
| TRX 680 FGA6 Fourtrax Rincon Gpscape             | 06-07 | FA410TT* | FA410R*    | MD6251D  | MD6251D  |          |         | FA373R   | MD6217D |         |
| TRX 680 FA6/7 Fourtrax Rubicon                   | 06-07 | FA410TT* | FA410R*    | MD6251D  | MD6251D  |          |         | FA373R   | MD6217D |         |
| NT 700 V6/V7 Deauville                           | 06-07 | FA388*   | FA388HH*   | MD1008LS | MD1008RS |          | FA261   | FA261HH  | MD1016  |         |
| NT 700 VA7 Deauville                             | 07    | FA388*   | FA388HH*   | TBA      | TBA      |          | FA261   | FA261HH  | TBA     |         |
| CB 750 F/F1                                      | 76-77 | FA13     |            | N/A      |          |          | FA32    |          | MD1064  |         |
| CB 750 F2  | 78    | FA31*    |            | N/A      | N/A      |          | FA30    |          | MD1064  |         |
| CB 750 FZ/FA/FB                                  | 78-82 | FA31*    |            | MD1036LS | MD1036RS |          | FA31    |          | MD1071  |         |
| CB 750 FC/F2C/FD/F2D                             | 83-84 | FA69/2*  |            | MD1036LS | MD1036RS |          | FA69    |          | MD1082  |         |

\*-2 Sets Required. ■ - Also available in MX-S race compound, see page 8. ✖ - Oversize and Supermoto disc available - see page 301.

**SAFETY WARNING:- DO NOT USE HH PADS ON REAR UNLESS ALSO USED ON FRONT TO AVOID BRAKE IMBALANCE.**

# JAPANESE Built Motorcycles



| Front/Avant/Vorn                   |                   | Frente/Anteriore    |  |  | Rear/Arrière/Hinten           |   | Posterior/Posteriore |   |
|------------------------------------|-------------------|---------------------|--|--|-------------------------------|---|----------------------|---|
| 1                                  | 2                 | 3                   | 4  | 5                                      | 6                             | 7 | 8                    | 9 |
| Sintered/HH Pads/<br>Grooved shoes | Left/Gauche/Links | Right/Droite/Rechts | Contour Rotor<br>Universal left<br>and right fitment | Sintered/<br>HH Pads/<br>Grooved shoes | Contour Rotor<br>Rear fitment |   |                      |   |

HONDA contd.

|  |       |          |          |          |          |          |         |          |         |
|--|-------|----------|----------|----------|----------|----------|---------|----------|---------|
| CB 750 F2N/F2R/F2S/F2T/F2V/F2W/F2X/F2Y<br>/F21 "CB Seven Fifty"        | 92-02 | FA142*   | FA142HH* | MD1008LS | MD1008RS |          | FA174   | FA174HH  | MD1020  |
| CB 750 K0-K6   | 69-77 | FA12     |          | N/A      |          |          | H320    |          |         |
| CB 750 K7  | 78    | FA13     |          | N/A      |          |          | H320    |          |         |
| CB 750 KZ  | 80    | FA45*    |          | MD1036LS | MD1036RS |          | H320    |          |         |
| CBR 750 FH "Superaero" (RC27)  | 87    | FA124*   | FA124HH* | MD1001LS | MD1001RS |          | FA69/3  | FA69/3HH | MD1006  |
| CBR 750 FJ "Superaero" (RC27)  | 88    | FA142*   | FA142HH* | MD1162LS | MD1162RS |          | FA196   | FA196HH  | MD1006  |
| CBX 750 FE   | 84    | FA69*    | FA69HH*  | MD1001LS | MD1001RS |          | FA69/3  | FA69/3HH | MD1079  |
| RVF 750 RR/RS "RC45"   | 94-98 | FA187*   | FA187HH* | MD1012LS | MD1012RS |          | FA143   |          | MD1013  |
| VF 750 S "Sabre"   | 82-83 | FA69*    | FA69HH*  | MD1001LS | MD1001RS |          | H321    |          |         |
| VF 750 C "Shadow"  | 83    | FA69     | FA69HH   | MD1047LS |          |          | H343    |          |         |
| VF 750 CH  | 87    | FA69/3   | FA69/3HH | MD1059LS |          |          | H343    |          |         |
| VF 750 CP/CR/CS/CT/CV/CW/CX  | 93-99 | FA196    | FA196HH  | MD1021LS |          |          | H343    |          |         |
| VF 750 FD/FE   | 83-84 | FA69*    | FA69HH*  | MD1083LS | MD1083RS |          | FA69/3  | FA69/3HH | MD1068  |
| VF 750 SC  | 82    | FA69*    | FA69HH*  | MD1001LS | MD1001RS |          | H321    |          |         |
| VFR 750 FG/FH  | 86-87 | FA124*   | FA124HH* | MD1001LS | MD1001RS |          | FA69/3  | FA69/3HH | MD1006  |
| VFR 750 FJ/FK  | 88-89 | FA142*   | FA142HH* | MD1008LS | MD1008RS |          | FA196   | FA196HH  | MD1006  |
| VFR 750 FL/FM/FN/FP  | 90-93 | FA142*   | FA142HH* | MD1008LS | MD1008RS |          | FA196   | FA196HH  | MD1007  |
| VFR 750 FR/FS/FT/FV  | 94-97 | FA142*   | FA142HH* | MD1003LS | MD1003RS | MD1003C* | FA196   | FA196HH  | MD1007  |
| VFR 750 RJ/RK/RL "RC30"  | 88-90 | FA187*   | FA187HH* | MD1010LS | MD1010RS |          | FA143   |          | MD1011  |
| VT 750 CV/C2V/CW/C2W/CX/C2X/CY/C2Y<br>/C21/C1/C31/C4/C5/C6/C7 "Shadow" | 97-07 | FA196    | FA196HH  | MD1008LS |          |          | H343    |          |         |
| VT 750 DC1/DC2 "Black Widow"   | 01-04 | FA196    | FA196HH  | MD1008LS |          |          | H343    |          |         |
| VT 750 DCA7 Shadow Spirit  | 07    | FA196    | FA196HH  | MD1008LS |          |          | H343    |          |         |
| XLV 750 R  | 83-88 | FA69     | FA69HH   | MD6044D  |          |          | H340    | H340G    |         |
| XRV 750 L/M/N "Africa Twin"  | 90-93 | FA121*   | FA121HH* | MD6102D  | MD6102DR |          | FA140   | FA140HH  | MD6103D |
| XRV 750 P/R/S/T/W/X/Y "Africa Twin"                                    | 94-03 | FA185TT* | FA185R*  | MD6102D  | MD6102DR |          | FA140   |          | MD6103D |
| PC 800 "Pacific coast"   | 89-97 | FA142*   | FA142HH* | MD1001LS | MD1001RS |          | H343    |          |         |
| VFR 800 FIW/FIX  | 98-99 |          | FA261HH* | MD1014LS | MD1014RS | MD1014C* |         | FA261HH  | MD1165  |
| VFR 800 FIY/FI1/2/3/4/5  | 00-05 |          | FA261HH* | MD1014LS | MD1014RS | MD1014C* |         | FA261HH  | MD1164  |
| VFR 800 A2/A3/A4/A5 (ABS Model)  | 02-05 |          | FA261HH* | MD1157LS | MD1157RS | MD1157C* |         | FA261HH  | MD1164  |
| VFR 800 6/7  | 06-07 |          | FA388HH* | MD1157LS | MD1157RS | MD1157C* |         | FA261HH  | MD1164  |
| VFR 800 A6/A7 (ABS Model)  | 06-07 |          | FA388HH* | MD1157LS | MD1157RS | MD1157C* |         | FA261HH  | MD1164  |
| CB 900 FZ/FA   | 80-81 | FA31*    |          | MD1036LS | MD1036RS |          | FA31    |          | MD1071  |
| CB 900 FB/F2B  | 82-83 | FA69/2*  |          | MD1036LS | MD1036RS |          | FA69    |          | MD1082  |
| CB 900 FC/F2C/FD/F2D   | 84-85 | FA69*    | FA69HH*  | MD1036LS | MD1036RS |          | FA69    | FA69HH   | MD1082  |
| CB 900 F2/F3/F4/F5/F6/F7 Hornet  | 02-07 | FA187*   | FA187HH* | MD1141LS | MD1141RS | MD1141C* | FA174   | FA174HH  | MD1020  |
| CBR 900 RRR/RRP "Fireblade"  | 92-93 | FA187*   | FA187HH* | MD1014LS | MD1014RS | MD1014C* | FA174   | FA174HH  | MD1004  |
| CBR 900 RRR/RRS/RRT/RRV "Fireblade"                                    | 94-97 | FA187*   | FA187HH* | MD1003LS | MD1003RS | MD1003C* | FA174   | FA174HH  | MD1004  |
| CBR 900 RRW/RRX "Fireblade"  | 98-99 | →        | FA265HH* | MD1134LS | MD1134RS | MD1134C* | FA174   | FA174HH  | MD1004  |
| CBR 900 "Evolution Blade"  | 99    | FA95*    | FA95HH*  | TBA      | TBA      |          | FA47    | FA47HH   | TBA     |
| CBR 900 RRY/RR1 "(929cc) Fireblade"                                    | 00-01 | →        | FA265HH* | MD1137LS | MD1137RS | MD1137C* | FA174   | FA174HH  | MD1004  |
| CBR 900 RR2/RR3 (954cc) Fireblade                                      | 02-03 | →        | FA265HH* | MD1137LS | MD1137RS | MD1137C* | FA174   | FA174HH  | MD1004  |
| CB 1000 FP/FR/FS/FT/FV   | 93-97 | FA187*   | FA187HH* | MD1056LS | MD1056RS |          | FA174   | FA174HH  | MD1016  |
| CBF 1000 FA6/FA7 (ABS Model)   | 06-07 |          | FA388HH* | MD1160LS | MD1160RS |          | FA388HH | TBA      |         |
| CBF 1000 F6/F7   | 06-07 | FA226*   | FA226HH* | MD1160LS | MD1160RS |          | FA174   | FA174HH  | MD1156  |
| CBR 1000 FH/FJ   | 87-88 | FA124*   | FA124HH* | MD1008LS | MD1008RS |          | FA69/3  | FA69/3HH | MD1001  |
| CBR 1000 FK/FL/FM/FN   | 89-92 | FA142*   | FA142HH* | MD1008LS | MD1008RS |          | FA196   | FA196HH  | MD1016  |
| CBR 1000 FP/FR/FS/FT/FV/FW/FX  | 93-99 | FA189*   | FA189HH* | MD1008LS | MD1008RS |          | FA189   | FA189HH  | MD1006  |
| CBR 1000 RR4/RR5 Fireblade   | 04-05 | →        | FA390HH* | MD1153LS | MD1153RS | MD1153C* | FA174   | FA174HH  | MD1004  |
| CBR 1000 RR6/RR7   | 06-07 |          | FA390HH* | MD1161LS | MD1161RS | MD1161C* | FA436   | FA436HH  | MD1004  |
| CBX 1000 Z   | 79-80 | FA29*    |          | MD1036LS | MD1036RS |          | FA30    |          | MD1071  |
| CBX 1000 B/C   | 81-82 | FA69/2*  |          | N/A      | N/A      |          | FA69    |          | MD1071  |
| GL 1000 K/K1/K2 "Goldwing"   | 75-77 | FA30*    |          | MD1074LS | MD1074RS |          | FA32    |          | MD1064  |
| GL 1000 K3 "Goldwing"  | 78    | FA29*    |          | N/A      | N/A      |          | FA32    |          | MD1064  |
| GL 1000 Z Goldwing   | 79    | FA29*    |          | MD1036LS | MD1036RS |          | FA32    |          | MD1064  |
| VF 1000 FE/FF/FG/F2F/F2G   | 84-86 | FA69*    | FA69HH*  | MD1001LS | MD1001RS |          | FA69/3  | FA69/3HH | MD1079  |
| VF 1000 RE/RF/RG   | 84-86 | FA69*    | FA69HH*  | MD1146LS | MD1146RS |          | FA109   |          | N/A     |
| VTR 1000 FV/FW/FX/FY<br>/F1/F2/F3/F4/F5/F6 "Firestorm"                 | 97-06 | FA187*   | FA187HH* | MD1003LS | MD1003RS | MD1003C* | FA174   | FA174HH  | MD1004  |

\*-2 Sets Required. ■ - Also available in MX-S race compound, see page 8. ✖ - Oversize and Supermoto disc available - see page 301.

**SAFETY WARNING:- DO NOT USE HH PADS ON REAR UNLESS ALSO USED ON FRONT TO AVOID BRAKE IMBALANCE.**

R Suffix = High Durability Sintered Pad. HH Suffix = High Performance Sintered Pad. G Suffix = Grooved Shoe.  
D Suffix = Drilled Disc. C Suffix = Contoured Disc. LS Suffix = Left/Steel Disc. RS = Right/Steel Disc.

BRAKE  
APPLICATIONS

# JAPANESE Built Motorcycles

APPLICATIONS

BRAKE

G Suffix = Grooved Shoe.

HH Suffix = High Performance Sintered Pad.

R Suffix = High Durability Sintered Pad.

RS = Right/Steel Disc.

LS Suffix = Left/Steel Disc.

C Suffix = Contoured Disc.

D Suffix = Drilled Disc.



## HONDA contd.

|  |       | Front/Avant/Vorn |                                |                   | Frente/Anterore     |  | Rear/Arrière/Hinten |                                | Posterior/Posteriore |                            |
|--|-------|------------------|--------------------------------|-------------------|---------------------|--|---------------------|--------------------------------|----------------------|----------------------------|
|  |       | ①                | ②                              | ③                 | ④                   | ⑤  | ⑥                   | ⑦                              | ⑧                    | ⑨                          |
|  |       |                  | Sintered/HH Pads/Grooved shoes | Left/Gauche/Links | Right/Droite/Rechts | Contour Rotor Universal left and right fitment |                     | Sintered/HH Pads/Grooved shoes |                      | Contour Rotor Rear fitment |
| VTR 1000 SP-Y/SP-1 (SC45) (SP1)                | 00-01 | →                | FA265HH*                       | MD1138LS          | MD1138RS            | MD1138C*                                       | FA174               | FA174HH                        | MD1004               | MD1004C                    |
| VTR 1000 SP-2/SP-3/SP-4/SP-5/SP-6 (SP2)        | 02-07 | →                | FA265HH*                       | MD1138LS          | MD1138RS            | MD1138C*                                       | FA174               | FA174HH                        | MD1004               | MD1004C                    |
| XL 1000 VX/XY/V1-V2 "Varadero" ③               | 99-02 | →                | FA261HH*                       | MD1014LS          | MD1014RS            | MD1014C*                                       | →                   | FA261HH                        | MD6103D              |                            |
| XL 1000 VA4/VA5/VA6/A7 Varadero                | 04-07 | →                | FA388HH*                       | MD1014LS          | MD1014RS            | MD1014C*                                       | →                   | FA261HH                        | MD1006               | MD1006C                    |
| XL 1000 V3/V4/V5/V6                            | 03-06 | →                | FA261HH*                       | MD1014LS          | MD1014RS            | MD1014C*                                       | →                   | FA261HH                        | MD1006               | MD1006C                    |
| CB 1100 RB2/RC2/RD2                            | 80-83 | FA69*            | FA69HH*                        | N/A               | N/A                 |  | FA69/3              | FA69/3HH                       | MD1116               |                            |
| CB 1100 SFY/SF1 "X11"                          | 00-03 | →                | FA261HH*                       | MD1136LS          | MD1136RS            | MD1136C*                                       | →                   | FA261HH                        | MD1006               | MD1006C                    |
| CBR 1100 XXV/XXW "Blackbird" ③                 | 97-98 | →                | FA261HH*                       | MD1120LS          | MD1120RS            |  | →                   | FA261HH                        | MD1006               |                            |
| CBR 1100 XXX/XXY/XX1/XX2/XX3                   |       |                  |                                |                   |                     |  |                     |                                |                      |                            |
| /XX4/XX5/XX6/XX7 Blackbird ③                   | 99-07 | →                | FA261HH*                       | MD1136LS          | MD1136RS            | MD1136C*                                       | →                   | FA261HH                        | MD1006               | MD1006C                    |
| GL 1100 AD "Goldwing Aspencade"                | 83    | FA69/2*          |                                | MD1133LS          | MD1133RS            |  | FA69                |                                | MD1082               |                            |
| GL 1100 A/DA/B/DB (SC02)                       | 80-82 | FA30*            |                                | MD1036LS          | MD1036RS            |  | FA30                |                                | MD1071               |                            |
| GL 1100 C/DC "Goldwing"                        | 82    | FA69/2*          |                                | MD1036LS          | MD1036RS            |  | FA69                |                                | MD1071               |                            |
| ST 1100 L/M/N/P/R/S/T/V/W/XY/Y1 "Pan European" | 90-01 | FA142*           | FA142HH*                       | MD1021LS          | MD1021RS            |  | FA196               | FA196HH                        | MD1077               |                            |
| ST 1100 AN/AP/AR/AS "Pan European"             | 92-95 | FA142*           | FA142HH*                       | MD1021LS          | MD1021RS            |  | FA196               | FA196HH                        | MD1077               |                            |
| ST 1100 AT/AV/AW/AX/AY/A1 "Pan European" ③     | 96-01 | →                | FA261HH*                       | MD1008LS          | MD1008RS            |  | →                   | FA261HH                        | MD1135               |                            |
| VT 1100 CH/CJ/CN/CP Shadow                     | 87-93 | FA69/3           | FA69/3HH                       |                   | MD1080RS            |  | H343                |                                |                      |                            |
| VT 1100 CR/CS/CT/CV/CW Shadow                  | 94-98 | FA196            | FA196HH                        |                   | MD1080RS            |  | H343                |                                |                      |                            |
| VT 1100 C3 Shadow                              | 03    | FA196            | FA196HH                        | MD1021LS          |                     |  | H343                |                                |                      |                            |
| VT 1100 C4 Shadow Sabre                        | 04-05 | FA196            | FA196HH                        | MD1021LS          |                     |  | FA174               | FA174HH                        | MD1016               |                            |
| GL 1200 DE/DF/DG "Goldwing" ①                  | 84-86 | FA69/3*          | FA69/3HH*                      | MD1083LS          | MD1083RS            |  | FA69/3              | FA69/3HH                       | MD1082               |                            |
| GL 1200 AE/AF/AG "Goldwing" ②                  | 84-86 | FA69/3*          | FA69/3HH*                      | MD1125LS          | MD1125RS            |  | FA69/3              | FA69/3HH                       | MD1082               |                            |
| "X4" CB 1300 DCV/DCW/DCX/DCY (SC38)            | 97-00 | FA187*           | FA187HH*                       | N/A               | N/A                 |  | FA254               | FA254HH                        | MD1001               |                            |
| CB 1300 FW/FX/FY (SC40)                        | 98-00 | FA424*           | FA424HH*                       | TBA               | TBA                 |  | FA254               | FA254HH                        | TBA                  |                            |
| CB 1300 F1 (SC40)                              | 01    | →                | FA265HH*                       | TBA               | TBA                 |  | FA254               | FA254HH                        | TBA                  |                            |
| CB 1300 F3/F13 "Super Four"                    | 03-04 | →                | FA296HH*                       | TBA               | TBA                 |  | FA174               | FA174HH                        | MD1006               |                            |
| CB 1300 5/6 (Superfour)                        | 05-06 | →                | FA296HH*                       | MD1152LS          | MD1152RS            | MD1152C*                                       | FA174               | FA174HH                        | TBA                  |                            |
| CB 1300 A5/A6/A7 (Superfour ABS)               | 05-07 | →                | FA296HH*                       | MD1152LS          | MD1152RS            | MD1152C*                                       | FA174               | FA174HH                        | TBA                  |                            |
| CB 1300 SA5/SA6/SA7 SuperBol-Dor               | 05-07 | →                | FA296HH*                       | MD1152LS          | MD1152RS            | MD1152C*                                       | FA174               | FA174HH                        | TBA                  |                            |
| ST 1300 2/A2/3/A3/4/A4/5/A5/6/A6/A7            |       |                  |                                |                   |                     |  |                     |                                |                      |                            |
| Pan European ③                                 | 02-07 | →                | FA261HH*                       | MD1154LS          | MD1154RS            | MD1154C*                                       | →                   | FA261HH                        | MD1163               |                            |
| VTX 1300 S3/S4/S5/S6/S7                        | 03-07 | FA196            | FA196HH                        |                   | MD1158RS            |  | FA174               | FA174HH                        | MD1159               |                            |
| GL 1500 J/K "Goldwing"                         | 88-89 | FA124/2*         | FA124/2HH*                     | MD1126LS          | MD1126RS            |  | FA69/3              | FA69/3HH                       | MD1127               |                            |
| GL 1500 L/SEM/SEN/SEP/SER/SES/SEV              |       |                  |                                |                   |                     |  |                     |                                |                      |                            |
| /SEW/SEX/SEY "Goldwing"                        | 90-00 | FA124/2*         | FA124/2HH*                     | MD1126LS          | MD1126RS            |  | FA69/3              | FA69/3HH                       | MD1077               |                            |
| GL 1500 CV/CW/CX (F6C)                         | 97-99 | FA142*           | FA142HH*                       | MD1014LS          | MD1014RS            | MD1014C*                                       | FA196               | FA196HH                        | MD1077               |                            |
| GL 1500 CY/C1/C2 (F6C)                         | 00-03 | FA142*           | FA142HH*                       | MD1014LS          | MD1014RS            | MD1014C*                                       | FA196               | FA196HH                        | MD1148               |                            |
| GL 1800 A1/A2/A3/A4/A5/A6/A7                   |       |                  |                                |                   |                     |  |                     |                                |                      |                            |
| "Goldwing" ③                                   | 01-07 | →                | FA261HH*                       | MD1014LS          | MD1014RS            | MD1014C*                                       | →                   | FA261/2HH                      | N/A                  |                            |
| VTX 1800 C2/C3/C4/C15 ③                        | 02-05 | →                | FA261HH*                       | MD1141LS          | MD1141RS            | MD1141C*                                       | →                   | FA261HH                        | MD1148               |                            |

- ① = with 4.7mm front disc
- ② = with 10.0mm vented front disc
- ③ = Note: Linked brake system - fit all three sets at pad change.

## KAWASAKI

|                                 |       |          |        |          |  |  |        |       |         |  |
|---------------------------------|-------|----------|--------|----------|--|--|--------|-------|---------|--|
| AE 50 A1/A2                     | 81-82 | S603     | S603G  |          |  |  | S603   | S603G |         |  |
| AR 50 A1/C2-C10                 | 81-97 | FA83TT   | FA83HH | MD4040LS |  |  | S603   |       |         |  |
| KDX 50 A1/A2/A3                 | 03-05 | S613     | S613G  |          |  |  | S613   | S613G |         |  |
| KFX 50 (KSF 50 A1/A2/A3)        | 03-05 | S614*    | S614G* |          |  |  | S604   | S604G |         |  |
| KSR1 (KMX 50 B1/B2)             | 90-91 | FA83/2TT |        | TBA      |  |  | FA67   |       | TBA     |  |
| KX 60 A1/A2/B1-B19              | 83-03 | K715     | K715G  |          |  |  | K715   | K715G |         |  |
| KX 65 A1/A2/A3/A4/A5/A6/A6F/A7F | 00-07 | FA302TT  | FA302R | MD6166D  |  |  | FA54TT | FA54R | MD6166D |  |
| AE 80 A1/B1                     | 81-82 | S603     | S603G  |          |  |  | S603   | S603G |         |  |
| AR 80 A1/C1-C8                  | 81-91 | FA83TT   | FA83HH | MD4040LS |  |  | S603   |       |         |  |
| KFX 80 (KSF 80 A1/A2/A3/A6F)    | 03-06 | S614*    | S614G* |          |  |  | S618   | S618G |         |  |
| KX 80 B1/B2/D1/D2               | 79-83 | K701     | K701G  |          |  |  | K701   | K701G |         |  |
| KX 80 E1                        | 83    | K714     | K714G  |          |  |  | K715   | K715G |         |  |
| KX 80 E2/E3/G1/G2/J1/J2         | 84-87 | FA83TT   | FA83R  | MD6027D  |  |  | K715   | K715G |         |  |
| KX 80 L1/L2/N2/L3/N3/R1/T1      | 88-91 | FA83TT   | FA83R  | MD6027D  |  |  | FA84TT | FA84R | MD6025D |  |

\*-2 Sets Required. ■ - Also available in MX-S race compound, see page 8. ✖ - Oversize and Supermoto disc available - see page 301.

**SAFETY WARNING:- DO NOT USE HH PADS ON REAR UNLESS ALSO USED ON FRONT TO AVOID BRAKE IMBALANCE.**



# JAPANESE Built Motorcycles



**KAWASAKI** contd.



|  |       | Front/Avant/Vorn |                                    |                   | Frente/Anteriore    |  | Rear/Arrière/Hinten |                                    | Posterior/Posteriore |                               |
|--|-------|------------------|------------------------------------|-------------------|---------------------|--|---------------------|------------------------------------|----------------------|-------------------------------|
|  |       | 1                | 2                                  | 3                 | 4                   | 5  | 6                   | 7                                  | 8                    | 9                             |
|  |       |                  | Sintered/HH Pads/<br>Grooved shoes | Left/Gauche/Links | Right/Droite/Rechts | Contour Rotor<br>Universal left<br>and right fitment |                     | Sintered/HH Pads/<br>Grooved shoes |                      | Contour Rotor<br>Rear fitment |
| KX 80 R2/T2/R3/T3/R4/T4/R5/T5/R6/T6          | 92-96 | FA83TT           | FA83R                              | MD6026D           |                     |  | FA84TT              | FA84R                              | MD6025D              |                               |
| KX 80 R7/W1/W2/W3                            | 97-00 | FA258TT          | FA258R                             | MD6026D           |                     |  | FA84TT              | FA84R                              | MD6025D              |                               |
| KX 85/85-2 A1-A5/A6F/A7F/B1-B5/B6F/B7F 01-07 |       | FA258TT          | FA258R                             | MD6186D*          |                     | MD6186C  | FA84TT              | FA84R                              | MD6187D              | MD6187C                       |
| KSR II (KMX 80 B1/B2)                        | 90-91 | FA83/2TT         |                                    | TBA               |                     |  | FA67                |                                    | TBA                  |                               |
| KC 100 C1-C4                                 | 80-83 | S603             |                                    |                   |                     |  | S603                |                                    |                      |                               |
| KE 100 A7-A10/B1-B15                         | 79-98 | S603             | S603G                              |                   |                     |  | S603                | S603G                              |                      |                               |
| KH 100 A2-A4                                 | 78-81 | S602             |                                    |                   |                     |  | S603                |                                    |                      |                               |
| KH 100 G2/G3                                 | 81-83 | FA48             |                                    | MD4116LS          |                     |  | S603                |                                    |                      |                               |
| KH 100 G4                                    | 83    | FA67             | FA67HH                             | MD4116LS          |                     |  | S603                |                                    |                      |                               |
| KH 100 G5-G8 (EX)                            | 84-87 | FA67             | FA67HH                             | MD4105LS          |                     |  | S602                |                                    |                      |                               |
| KM 100 A4-A6                                 | 78-81 | S603             | S603G                              |                   |                     |  | S603                | S603G                              |                      |                               |
| KX 100 A1/A2/B1                              | 89-91 | FA83TT           | FA83R                              | MD6027D           |                     |  | FA84TT              | FA84R                              | MD6025D              |                               |
| KX 100 B2-B6                                 | 92-96 | FA83TT           | FA83R                              | MD6026D           |                     |  | FA84TT              | FA84R                              | MD6025D              |                               |
| KX 100 B7/C1/C2/C3                           | 97-00 | FA258TT          | FA258R                             | MD6026D           |                     |  | FA84TT              | FA84R                              | MD6025D              |                               |
| Max 100                                      |       | S603             |                                    |                   |                     |  | S603                |                                    |                      |                               |
| KLF 110 B1-B2 "Mojave"                       | 87-88 | S603             | S603G                              |                   |                     |  | K602A               | K602AG                             |                      |                               |
| KLX 110 R (KLX 110 A1/A2/A3/A4/A6F)          | 02-06 | K715             | K715G                              |                   |                     |  | S603                | S603G                              |                      |                               |
| Kaze-r 112cc                                 | 04    | FA197            | FA197HH                            | N/A               |                     |  | S603                |                                    |                      |                               |
| Kaser 115                                    |       | FA165TT          |                                    | N/A               |                     |  | S603                |                                    |                      |                               |
| AR 125 A1-A7/B1-B8                           | 82-94 | FA67             | FA67HH                             | MD4099LS          |                     |  | K602A               |                                    |                      |                               |
| BN 125 A1/A2 "Eliminator"                    | 98-99 | FA54TT           | FA54HH                             |                   | MD4137RS            |  | K602A               |                                    |                      |                               |
| BN 125 A3/A4/A5/A6/A6F/A7F Eliminator 00-07  |       | FA197            | FA197HH                            |                   | MD4137RS            |  | K602A               |                                    |                      |                               |
| KDX 125 A1/A2/B1/B2                          | 90-94 | FA83TT           | FA83R                              | MD6083D           |                     |  | FA152TT             | FA152R■                            | MD6105D              |                               |
| KE 125 A4-A12                                | 76-85 | K704             | K704G                              |                   |                     |  | K602A               | K602AG                             |                      |                               |
| KH 125 A1-A4                                 | 77-81 | FA39             |                                    | N/A               |                     |  | K702                |                                    |                      |                               |
| KH 125 K1                                    | 83    | FA54TT           | FA54HH                             | N/A               |                     |  | S602                |                                    |                      |                               |
| KH 125 K2-K10                                | 82-98 | FA67             | FA67HH                             | N/A               |                     |  | S602                |                                    |                      |                               |
| KH 125 L1 (EX)                               | 84    | FA67             | FA67HH                             | MD4105LS          |                     |  | S602                |                                    |                      |                               |
| KLX 125 A1/A2/A3/A6F                         | 03-06 | S604             | S604G                              |                   |                     |  | S604                | S604G                              |                      |                               |
| KLX 125 L (B1/B2/B3/B6F)                     | 03-06 | FA230TT          | FA230R                             | MD6212D           |                     |  | S604                | S604G                              |                      |                               |
| KMX 125 A1-A5/B1-B9                          | 86-98 | FA83TT           | FA83R                              | MD6106D           |                     |  | FA67                | FA67R                              | MD6107D              |                               |
| KMX 125 B10-B12                              | 99-03 | FA230TT          | FA230R                             | MD6106D           |                     |  | FA67                | FA67R                              | MD6107D              |                               |
| KX 125 A3-A7                                 | 74-80 | K704             | K704G                              |                   |                     |  | K602A               | K602AG                             |                      |                               |
| KX 125 B1                                    | 82    | FA83TT           | FA83R                              | N/A               |                     |  | K602A               | K602AG                             |                      |                               |
| KX 125 B2/C1                                 | 83-84 | FA67             | FA67R                              | N/A               |                     |  | K702                | K702G                              |                      |                               |
| KX 125 D1                                    | 85    | FA67             | FA67R                              | MD6036D           |                     |  | K702                | K702G                              |                      |                               |
| KX 125 E1                                    | 86    | FA67             | FA67R                              | MD6036D           |                     |  | FA67                | FA67R                              | MD6161D              |                               |
| KX 125 E2/F1                                 | 87-88 | FA130            | FA130R                             | MD6036D           |                     |  | FA67                | FA67R                              | MD6161D              |                               |
| KX 125 G1/H1/H2/J1/J2                        | 89-93 | FA135TT          | FA135R■                            | MD6015D           |                     | MD6015C  | FA152TT             | FA152R■                            | MD6024D              | MD6024C                       |
| KX 125 K1                                    | 94    | FA185TT          | FA185R■                            | MD6015D*          |                     | MD6015C  | FA152TT             | FA152R■                            | MD6024D              | MD6024C                       |
| KX 125 K2/K3/K4/K5/L1/L2/L3/L4               | 95-02 | FA185TT          | FA185R■                            | MD6015D*          |                     | MD6015C  | FA131TT             | FA131R■                            | MD6024D              | MD6024C                       |
| KX 125 M1/M2/M3                              | 03-05 | FA185TT          | FA185R■                            | MD6213D*          |                     | MD6213C  | FA131TT             | FA131R■                            | MD6208D              | MD6208C                       |
| KX 125 M6F/M7F 06-07                         |       | FA185TT          | FA185R■                            | MD6264D*          |                     | MD6264C  | FA131TT             | FA131R■                            | MD6208D              | MD6208C                       |
| SC 150 A1 (Epsilon 150)                      | 02    | FA396            |                                    | MD934D            |                     |  | S635                |                                    |                      |                               |
| BN 175 Boss 175                              | 02    | TBA              |                                    |                   | N/A                 |  | TBA                 |                                    |                      |                               |
| KDX 175 A1-A3                                | 80-82 | K704             | K704G                              |                   |                     |  | K602A               | K602AG                             |                      |                               |
| KE 175 B1-B3                                 | 76-78 | K704             | K704G                              |                   |                     |  | K602A               | K602AG                             |                      |                               |
| KE 175 D2-D5                                 | 79-83 | K704             | K704G                              |                   |                     |  | K703                | K703G                              |                      |                               |
| KLF 185 A1                                   | 87    | None             |                                    |                   |                     |  | K706                | K706G                              |                      |                               |
| KDX 200 A1-A3                                | 83-85 | K703             | K703G                              |                   |                     |  | K702                | K702G                              |                      |                               |
| KDX 200 C1/C2/C3                             | 86-88 | FA67             | FA67R                              | MD6036D           |                     |  | K702                | K702G                              |                      |                               |
| KDX 200 E1/E2/E3/E4                          | 89-92 | FA67             | FA67R                              | MD6036D           |                     |  | FA152TT             | FA152R■                            | MD6024D              |                               |
| KDX 200 E5/E6                                | 93-94 | FA135TT          | FA135R■                            | MD6015D           |                     | MD6015C  | FA152TT             | FA152R■                            | MD6024D              | MD6024C                       |
| KDX 200 H1/H2/H3/H4/H5                       | 95-99 | FA185TT          | FA185R■                            | MD6083D           |                     |  | FA152TT             | FA152R■                            | MD6105D              |                               |
| KDX 200 SR (DX200G)                          |       | FA135TT          | FA135R■                            | MD6036D           |                     |  | FA152TT             | FA152R■                            | MD6105D              |                               |
| KLT 200 A1/A4A/C1/C2                         | 81-84 | S603             | S603G                              |                   |                     |  | K705                | K705G                              |                      |                               |
| KMX 200 A2/A3                                | 88-92 | FA83TT           | FA83R                              | MD6057D           |                     |  | FA67                | FA67R                              | MD6108D              |                               |
| Z 200 A1-A5                                  | 77-82 | FA39             |                                    | N/A               |                     |  | K602A               |                                    |                      |                               |
| Z 200 A6                                     | 83    | FA67             | FA67HH                             | N/A               |                     |  | K602A               |                                    |                      |                               |
| KLF 220 A1-A15                               | 88-02 | K705*            | K705G*                             |                   |                     |  | K706                | K706G                              |                      |                               |

\*-2 Sets Required. ■ - Also available in MX-S race compound, see page 8. ✕ - Oversize and Supermoto disc available - see page 301.

**SAFETY WARNING:- DO NOT USE HH PADS ON REAR UNLESS ALSO USED ON FRONT TO AVOID BRAKE IMBALANCE.**

**R** Suffix = High Durability Sintered Pad. **HH** Suffix = High Performance Sintered Pad. **G** Suffix = Grooved Shoe.  
**D** Suffix = Drilled Disc. **C** Suffix = Contoured Disc. **LS** Suffix = Left/Steel Disc. **RS** = Right/Steel Disc.

**BRAKE APPLICATIONS**

# JAPANESE Built Motorcycles

APPLICATIONS

BRAKE



| Front/Avant/Vorn | Front/Avant/Vorn                   |                                    | Frente/Anteriores |                     | Rear/Arrière/Hinten                                  | Posterior/Posteriore               |                                    |                               |
|------------------|------------------------------------|------------------------------------|-------------------|---------------------|--|------------------------------------|------------------------------------|-------------------------------|
|                  | 1                                  | 2                                  | 3                 | 4                   |  | 6                                  | 7                                  | 8                             |
|                  | Sintered/HH Pads/<br>Grooved shoes | Sintered/HH Pads/<br>Grooved shoes | Left/Gauche/Links | Right/Droite/Rechts | Contour Rotor<br>Universal left<br>and right fitment | Sintered/HH Pads/<br>Grooved shoes | Sintered/HH Pads/<br>Grooved shoes | Contour Rotor<br>Rear fitment |

**KAWASAKI** contd.

|                                    |       |          |          |          |          |         |         |         |         |         |
|------------------------------------|-------|----------|----------|----------|----------|---------|---------|---------|---------|---------|
| KDX 220 R A4-A12/A6F               | 97-06 | FA185TT  | FA185R■  | MD6083D  |          |         | FA152TT | FA152R■ | MD6105D |         |
| KDX 220 SR (DX 220 B)              |       | FA185TT  | FA185R■  | MD6083D  |          |         | FA152TT | FA152R■ | MD6105D |         |
| 250 SIB                            | 75    | K711     |          |          |          |         | K708    |         |         |         |
| ER 250 B1/B2/B3 (Z 250 T Scorpion) | 83-88 | FA85     | FA85HH   | MD4099LS |          |         | K706    |         |         |         |
| EL 250 D1-D5                       | 90-94 | FA85     | FA85HH   | MD4002LS |          |         | K706    |         |         |         |
| EL 252 (EX 250 F2/F5)              | 97-03 | FA67     | FA67HH   |          | MD4002RS |         | K706    |         |         |         |
| EL 250 "Eliminator"                | 87-89 | FA85     | FA85HH   |          | MD4002RS |         | K706    |         |         |         |
| BJ 250 B1-B7A "Estrella"           | 92-99 | FA67     | FA67HH   |          | TBA      |         | FA67    | FA67HH  | TBA     |         |
| BJ 250 C1-C7 "Estrella-RS"         | 99-02 | FA67     | FA67HH   |          | TBA      |         | FA67    | FA67HH  | TBA     |         |
| BJ 250 D1-D7 "Estrella Custom"     | 96-02 | S612     |          |          |          |         | K706    |         |         |         |
| BJ 250 E1-E4A Estrella RS Custom   | 96-99 | S612     |          |          |          |         | K706    |         |         |         |
| BJ 250 F1/F2 (250 TR)              | 02-03 | FA231    | FA231HH  | TBA      |          |         | K706    |         |         |         |
| GPX 250 R (ZX 250 F2-F9)           | 88-95 | FA129    | FA129HH  |          | MD4041RS |         | FA141   |         | MD4042  |         |
| GPX 250 R (EX 250 E)               | 86    | FA85     | FA85HH   | MD4002LS |          |         | FA85    | FA85HH  | MD4032  |         |
| GPX 250 R (EX 250 F)               | 87    | FA129    | FA129HH  |          | MD4041RS |         | FA141   |         | MD4042  |         |
| GPX 250 RII (EX 250 G)             | 88    | FA141*   |          | TBA      | TBA      |         | FA141   |         | MD4042  |         |
| KDX 250 B1                         | 79    | K705     | K705G    |          |          |         | S605    | S605G   |         |         |
| KDX 250 B2/B3                      | 80-84 | K705     | K705G    |          |          |         | K602A   | K602AG  |         |         |
| KDX 250 D1                         | 91-93 | FA135TT  | FA135R■  | MD6083D  |          |         | FA152TT | FA152R■ | MD6105D |         |
| KH 250 B1-B5                       | 77-82 | FA33     |          | N/A      |          |         | K708    |         |         |         |
| KDX 250 SR (KDX 250 F1)            | 91    | FA135TT  | FA135R■  | MD6083D  |          |         | FA152TT | FA152R■ | MD6105D |         |
| KL 250 A1/A2                       | 78-79 | K705     | K705G    |          |          |         | S605    | S605G   |         |         |
| KL 250 A3/A4/C1/C2                 | 80-84 | K704     | K704G    |          |          |         | K703    | K703G   |         |         |
| KL 250 J1/J3 Stockman              |       | FA258TT  | FA258R   | MD6239D  |          |         | FA67TT  | FA67R   | MD6107D |         |
| KL 250 G1/G1A Super Sherpa         | 97    | FA258TT  | FA258R   | MD6239D  |          |         | FA67    | FA67R   | MD6107D |         |
| KLE 250 A2 'Anhelo'                | 95    | FA129    | FA129R   | TBA      |          |         | FA67/3  |         | TBA     |         |
| KLE 250 A3                         | 97    | FA129    | FA129R   | TBA      |          |         | FA67/3  |         | TBA     |         |
| KLE 250 A5/A6                      | 00-01 | FA129    | FA129R   | TBA      |          |         | FA67/3  |         | TBA     |         |
| KLX 250 H1 "Super Sherpa"          | 98    | FA258TT  | FA258R   | MD6239D  |          |         | FA67    | FA67R   | MD6107D |         |
| KLF 250 A1/A2/A3/A6F (Bayou 250)   | 03-06 | K705*    | K705G*   |          |          |         | K706    | K706G   |         |         |
| KLR 250 D2-D22                     | 84-05 | FA67     | FA67R    | MD6057D  |          |         | K703    | K703G   |         |         |
| KLT 250 C1-C3 "Prairie"            | 83-85 | S603     | S603G    |          |          |         | K705    | K705G   |         |         |
| KLX 250 R D1/D2                    | 93-94 | FA185TT  | FA185R■  | MD6015D✘ |          | MD6015C | FA152TT | FA152R■ | MD6085D |         |
| KLX 250 F1-F4 (KLX 250 ES)         | 94-97 | FA185TT  | FA185R■  | MD6091D  |          |         | FA152TT | FA152R■ | MD6085D |         |
| KLX 250 G1                         | 94    | FA185TT  | FA185R■  | MD6091D  |          |         | FA152TT | FA152R■ | MD6085D |         |
| KLX 250 J1-J6 "D-Tracker"          | 98-03 | FA185TT  | FA185R■  | MD6240D✘ |          | MD6240C | FA131TT | FA131R■ | MD6105D |         |
| KLX 250 H6                         | 05    | FA185TT  | FA185R■  | MD6015D  |          | MD6015C | FA131TT | FA131R  | MD6105D |         |
| KR-1 (KR 250 B2)                   | 89    | FA141*   |          | MD4095LS | MD4095RS |         | FA141   |         | MD4096  |         |
| KR-1S (KR 250 C2/C3)               | 90-92 | FA158*   | FA158HH* | MD4008LS | MD4008RS | MD4008C | FA141   |         | MD4096  |         |
| KR 250 A1/A2                       | 84-86 | FA67*    | FA67HH*  | TBA      | TBA      |         | FA85    | FA85HH  | TBA     |         |
| KSF 250 A8/A18 (KFX 250 Mojave)    | 94-04 | FA128TT* | FA128R*  | MD6133D  | MD6133D  |         | FA84TT  | FA84R   | MD6132D |         |
| KT 250 "All models"                | 75-80 | K704     | K704G    |          |          |         | K602A   | K602AG  |         |         |
| KX 250 B1                          | 82    | FA83TT   | FA83R    | N/A      |          |         | K602A   | K602AG  |         |         |
| KX 250 C1/C2                       | 83-84 | FA67     | FA67R    | N/A      |          |         | K602A   | K602AG  |         |         |
| KX 250 D1                          | 85    | FA67     | FA67R    | MD6036D  |          |         | K602A   | K602AG  |         |         |
| KX 250 D2                          | 86    | FA67     | FA67R    | MD6036D  |          |         | FA67    | FA67R   | MD6161D |         |
| KX 250 E1/F1                       | 87-88 | FA130    | FA130R   | MD6036D  |          |         | FA67    | FA67R   | MD6161D |         |
| KX 250 G1/H1/H2/J1/J2              | 89-93 | FA135TT  | FA135R■  | MD6015D  |          | MD6015C | FA152TT | FA152R■ | MD6024D | MD6024C |
| KX 250 K1                          | 94    | FA185TT  | FA185R■  | MD6015D✘ |          | MD6015C | FA152TT | FA152R■ | MD6024D | MD6024C |
| KX 250 K2/K3/K4/K5/L1/L2/L3/L4     | 95-02 | FA185TT  | FA185R■  | MD6015D✘ |          | MD6015C | FA131TT | FA131R■ | MD6024D | MD6024C |
| KX 250 M1/M2/R1                    | 03-05 | FA185TT  | FA185R■  | MD6213D✘ |          | MD6213C | FA131TT | FA131R■ | MD6208D | MD6208C |
| KX 250 F (KX 250 N1/N2)            | 04-05 | FA185TT  | FA185R■  | MD6213D✘ |          | MD6213C | FA367TT | FA367R■ | MD6208D | MD6208C |
| KX 250 R6F/R7F                     | 06-07 | FA185TT  | FA185R■  | MD6264D✘ |          | MD6264C | FA131TT | FA131R■ | MD6208D | MD6208C |
| KX 250 F (T6F/T7F)                 | 06-07 | FA185TT  | FA185R■  | MD6264D✘ |          | MD6264C | FA367TT | FA367R■ | MD6208D | MD6208C |
| KXF 250 A1/A2 "Tecate 4"           | 87-88 | FA128TT* | FA128R*  | MD6133D  | MD6133D  |         | FA83TT  | FA83R   | MD6136D |         |
| KXT 250 A1 "Tecate"                | 84    | K705     | K705G    |          |          |         | FA83TT  | FA83R   | N/A     |         |
| SC 250 A1 (Epsilon 250)            | 02    | FA283*   | FA283HH* | MD929D   |          |         | FA323/3 |         | MD930D  |         |
| Z 250 A1/A2                        | 78-80 | FA73     |          | N/A      |          |         | FA161   |         | N/A     |         |
| Z 250 A3                           | 81    | FA68     | FA68HH   | MD4010LS |          |         | FA161   | FA161HH | N/A     |         |
| Z 250 B1/B2                        | 80-83 | K711     |          |          |          |         | K706    |         |         |         |

\*-2 Sets Required. ■ - Also available in MX-S race compound, see page 8. ✘ - Oversize and Supermoto disc available - see page 301.

**SAFETY WARNING:- DO NOT USE HH PADS ON REAR UNLESS ALSO USED ON FRONT TO AVOID BRAKE IMBALANCE.**

# JAPANESE Built Motorcycles



**KAWASAKI** contd.

|   |                 | Front/Avant/Vorn                   |                   |                     | Frente/Anteriere                                     |          | Rear/Arrière/Hinten                |         | Posterior/Posteriore          |         |
|---|-----------------|------------------------------------|-------------------|---------------------|--|----------|------------------------------------|---------|-------------------------------|---------|
|   |                 | ①                                  | ②                 | ③                   | ④  | ⑤        | ⑥                                  | ⑦       | ⑧                             | ⑨       |
|   |                 | Sintered/HH Pads/<br>Grooved shoes | Left/Gauche/Links | Right/Droite/Rechts | Contour Rotor<br>Universal left<br>and right fitment |          | Sintered/HH Pads/<br>Grooved shoes |         | Contour Rotor<br>Rear fitment |         |
| Z 250 C1/C2/G1/G2                       | 81-83           | K711                               |                   |                     |  |          | K602A                              |         |                               |         |
| ZR 250 A1-A5 Ballus                     | 91-95           | FA129                              | FA129HH           |                     | MD4008RS   | MD4008C  | FA67/3                             |         | MD4051                        | MD4051C |
| ZR 250 B6 (Ballus-II)                   | 02              | FA231                              | FA231HH           |                     | MD4008RS   | MD4008C  | FA67                               | FA67HH  | MD4051                        | MD4051C |
| ZZR 250 (EX 250 H1-H13)                 | 90-01           | FA129                              | FA129HH           |                     | MD4008RS   | MD4008C  | FA67/3                             |         | MD4117                        |         |
| ZXR 250 (ZX 250 A1/A2)                  | 89-90           | FA141*                             |                   | MD4008LS            | MD4008RS   | MD4008C* | FA141                              |         | MD4051                        | MD4051C |
| ZXR 250 R (ZX 250 B1/B2)                | 89-90           | FA141*                             |                   | MD4008LS            | MD4008RS   | MD4008C* | FA141                              |         | MD4051                        | MD4051C |
| ZXR 250 C1-C3 (ZX 250 C1-C3)            | 91-95           | FA141*                             |                   | MD4149LS            | MD4149RS   |          | FA67/3                             |         | MD4051                        | MD4051C |
| ZXR 250 R (ZX 250 D1)                   | 91              | FA141*                             |                   | MD4149LS            | MD4149RS   |          | FA67/3                             |         | MD4051                        | MD4051C |
| KAF 300 A1/B1/B2 (Mule 500)             |                 | S628*                              | S628G*            |                     |  |          | K718*                              | N/A     |                               |         |
| KAF 300 C1/C2/C3/C4/C6/C7/D1 (Mule 550) |                 | S628*                              | S628G*            |                     |  |          | K718*                              | N/A     |                               |         |
| KEF 300 B1/B2/B3 Lakota Sport           | 01-03           | FA128TT*                           | FA128R*           | MD6133D             | MD6133D  |          | FA84TT                             | FA84R   | MD6132D                       |         |
| KLF 300 A1/A2 "Bayou"                   | 86-87           | K717*                              | K717G*            |                     |  |          | K706                               | K706G   |                               |         |
| KLF 300 B1-B17 "Bayou"                  | 88-04           | FA67*                              | FA67R*            | MD6133D             | MD6133D  |          | K706                               | K706G   |                               |         |
| KLF 300 C1-C17 "Bayou"                  | Left Hand 89-05 | FA135TT                            | FA135R            | MD6131D             |  |          | K710                               | K710G   |                               |         |
|   | Right Hand      | FA165TT                            | FA165R            |                     | MD6131D  |          |                                    |         |                               |         |
| KLX 300 A2-A10/A6F/A7F                  | 97-07           | FA185TT                            | FA185R            | MD6015D             |  |          | FA131TT                            | FA131R  | MD6105D                       |         |
| KVF 300 A1/A2/A3/A4 (Prairie 4 x 4)     | 99-02           | FA54TT*                            | FA54R*            | MD6131D             | MD6131D  |          | K710                               | K710G   |                               |         |
| KVF 300 B1/B2/B3/B4 (Prairie 2 x 4)     | 99-02           | FA54TT*                            | FA54R*            | MD6131D             | MD6131D  |          | K710                               | K710G   |                               |         |
| GPZ 305 A1/B1-B10                       | 83-96           | FA67*                              | FA67HH*           | MD4105LS            | MD4105RS   |          | K706                               |         |                               |         |
| KVF 360 A1-A3/A6F/B1-B3/B6F             |                 |                                    |                   |                     |  |          |                                    |         |                               |         |
| /C1-C3/C6F Prairie All models           | 03-06           | FA54TT*                            | FA54R*            | MD6188D             | MD6188D  |          | N/A                                |         |                               |         |
| KH 400 "All Models"                     | 76-81           | FA33                               |                   | N/A                 |  |          | K708                               |         |                               |         |
| KLF 400 B1-B7 "Bayou"                   | Left Hand 93-99 | FA135TT                            | FA135R            | MD6131D             |  |          | K710                               | K710G   |                               |         |
|   | Right Hand      | FA165TT                            | FA165R            |                     | MD6131D  |          |                                    |         |                               |         |
| KSF 400 A1/A2/A3/A6F (KFX 400)          | 03-06           | FA84TT*                            | FA84R*            | MD6210D             | MD6210D  |          | FA137TT                            | FA137R  | MD6211D                       |         |
| KVF 400 A1/A2/B1 "Prairie"              | 97-98           | FA54TT*                            | FA54R*            | MD6131D             | MD6131D  |          | K710                               | K710G   |                               |         |
| KVF 400 C1/C2/C3/C4 (Prairie 4 x 4)     | 99-02           | FA54TT*                            | FA54R*            | MD6131D             | MD6131D  |          | K710                               | K710G   |                               |         |
| KVF 400 D1/D2/D3 (Prairie 2 x 4)        | 99-01           | FA54TT*                            | FA54R*            | MD6131D             | MD6131D  |          | K710                               | K710G   |                               |         |
| Z 400 B1/B2                             | 78-80           | FA48                               |                   | N/A                 |  |          | K706                               |         |                               |         |
| Z 400 G1                                | 79              | FA33                               |                   | N/A                 |  |          | K706                               |         |                               |         |
| Z 400 J1                                | 80              | FA73*                              |                   | MD4047LS            | MD4047RS   |          | K709                               |         |                               |         |
| Z 400 J2/J3                             | 81-83           | FA68*                              | FA68HH*           | MD4010LS            | MD4010RS   |          | K709                               |         |                               |         |
| ZR 400 A1/B1 (Z 400 F)                  | 83-84           | FA67*                              | FA67HH*           | MD4108LS            | MD4108RS   |          | K706                               |         |                               |         |
| Z 400 C2/C3 (Z 400 F2)                  | 85-87           | FA67*                              | FA67HH*           | MD4028LS            | MD4028RS   |          | FA85                               | FA85HH  | MD4001                        |         |
| ZL 400 A "Eliminator"                   | 86-87           | FA85                               | FA85HH            | MD4016LS            |  |          | K709                               |         |                               |         |
| ZL 400 B "Eliminator 400 SE"            | 88              | FA67*                              | FA67HH*           | MD4135LS            | MD4135RS   |          | K709                               |         |                               |         |
| FX 400 R (ZX 400 E1-E3)                 | 86-88           | FA67*                              | FA67HH*           | MD4135LS            | MD4135RS   |          | FA85                               | FA85HH  | MD4015                        |         |
| GPZ 400 R (ZX 400 D/D3/D3A)             | 85-87           | FA67*                              | FA67HH*           | MD4135LS            | MD4135RS   |          | FA85                               | FA85HH  | MD4015                        |         |
| GPZ 400 R "D4"                          | 88              | FA141*                             |                   | MD4143LS            | MD4143RS   |          | FA129                              |         | TBA                           |         |
| GPX 400 R (ZX 400 F1)                   | 87              | FA141*                             |                   | MD4140LS            | MD4140RS   |          | FA129                              |         | MD4027                        |         |
| KLX 400 R (KLX 400 B1/B2)               | 03-04           | FA185TT                            | FA185R            | MD6017D*            |  | MD6017C  | FA131TT                            | FA131R  | MD6014D                       | MD6014C |
| ZR 400 D1/D3/D4 "Xanthus"               | 92-95           | FA141*                             |                   | TBA                 | TBA  |          | FA67/3                             |         | TBA                           |         |
| ZR 400 Zephyr (G2/G3/G3A/G4/G5)         | 97-01           | FA158*                             | FA158HH*          | TBA                 | TBA  |          | FA192                              | FA192HH | MD4009                        |         |
| ZRX 400 (ZR 400 E1/E2)                  | 94-95           | FA129                              | FA129HH           | MD4008LS            | MD4008RS   | MD4008C* | FA192                              | FA192HH | TBA                           |         |
| ZRX 400 E3 (ZR 400 E3)                  | Left 96         | FA229                              | FA229HH           | MD4008LS            | MD4008RS   | MD4008C* | FA192                              | FA192HH | TBA                           |         |
|   | Right           | FA231                              | FA231HH           |                     |  |          |                                    |         |                               |         |
| ZRX 400 (ZX 400 E4/E5/E6/E7)            | 98-01           |                                    | FA294HH*          | MD4008LS            | MD4008RS   | MD4008C* | FA192                              | FA192HH | TBA                           |         |
| ZX-4 (ZX 400 G1/G1A/G1B)                | 88              | FA141*                             |                   | MD4134LS            | MD4134RS   |          | FA141                              |         | MD4009                        |         |
| ZXR 400 H1/H2                           | 89-90           | FA158*                             | FA158HH*          | MD4008LS            | MD4008RS   | MD4008C* | FA161                              | FA161HH | MD4009                        | MD4009C |
| ZXR 400 R (ZXR 400 J1)                  | 89              | FA158*                             | FA158HH*          | MD4008LS            | MD4008RS   | MD4008C* | FA161                              | FA161HH | MD4009                        | MD4009C |
| ZXR 400 R (ZX 400 J2)                   | 90              | FA158*                             | FA158HH*          | MD4008LS            | MD4008RS   | MD4008C* | FA161                              | FA161HH | MD4009                        | MD4009C |
| ZXR 400 R (ZX 400 M1-M4)                | 91-94           | FA158*                             | FA158HH*          | MD4005LS            | MD4005RS   |          | FA161                              | FA161HH | MD4009                        |         |
| ZXR 400 L1-L9                           | 91-03           | FA180*                             | FA180HH*          | MD4005LS            | MD4005RS   |          | FA161                              | FA161HH | MD4009                        |         |
| ZZ-R 400 (ZX 400 K1/K2/K3)              | 90-92           | FA158*                             | FA158HH*          | MD4008LS            | MD4008RS   | MD4008C* | FA129                              | FA129HH | MD4007                        |         |
| ZZ-R 400 (ZX 400 N1-N7)                 | 93-99           | FA158*                             | FA158HH*          | MD4008LS            | MD4008RS   | MD4008C* | FA192                              | FA192HH | MD4009                        | MD4009C |
| KX 420 A1/A2                            | 80-81           | K705                               | K705G             |                     |  |          | S605                               | S605G   |                               |         |
| Z 440 A2 "LTD"                          | 79              | FA73                               |                   | MD4047LS            |  |          | K706                               |         |                               |         |
| Z 440 C1                                | 80              | FA73                               |                   | N/A                 |  |          | K706                               |         |                               |         |
| Z 440 C2                                | 81              | FA68                               | FA68HH            | MD4010LS            |  |          | K706                               |         |                               |         |
| Z 440 D4 "LTD"                          | 82              | FA73                               |                   | MD4047LS            |  |          | K706                               |         |                               |         |

\*-2 Sets Required. ■ - Also available in MX-S race compound, see page 8. ✖ - Oversize and Supermoto disc available - see page 301.

**SAFETY WARNING:- DO NOT USE HH PADS ON REAR UNLESS ALSO USED ON FRONT TO AVOID BRAKE IMBALANCE.**

**R** Suffix = High Durability Sintered Pad. **HH** Suffix = High Performance Sintered Pad. **G** Suffix = Grooved Shoe.  
**D** Suffix = Drilled Disc. **C** Suffix = Contoured Disc. **LS** Suffix = Left/Steel Disc. **RS** = Right/Steel Disc.

**BRAKE APPLICATIONS**

# JAPANESE Built Motorcycles

APPLICATIONS

BRAKE



| 1 | Front/Avant/Vorn                   |                   | Frente/Anteriores   |  | Rear/Arrière/Hinten |                                    | Posterior/Posteriore |                               |
|---|------------------------------------|-------------------|---------------------|--|---------------------|------------------------------------|----------------------|-------------------------------|
|   | 2                                  | 3                 | 4                   | 5  | 6                   | 7                                  | 8                    | 9                             |
|   | Sintered/HH Pads/<br>Grooved shoes | Left/Gauche/Links | Right/Droite/Rechts | Contour Rotor<br>Universal left<br>and right fitment |                     | Sintered/HH Pads/<br>Grooved shoes |                      | Contour Rotor<br>Rear fitment |

**KAWASAKI** contd.

|                                 |       |         |            |          |          |          |         |         |         |         |
|---------------------------------|-------|---------|------------|----------|----------|----------|---------|---------|---------|---------|
| Z 440 D5/D6 "LTD"               | 83-84 | FA68    | FA68HH     | MD4010LS |          |          | K706    |         |         |         |
| Z 440 H1/H2                     | 82-83 | FA68    | FA68HH     | MD4010LS |          |          | K706    |         |         |         |
| LTD 450 (EN 450 A1-A5)          | 86-89 | FA85    | FA85HH     | MD4006LS |          |          | K709    |         |         |         |
| KAF 450 B1 (Mule 1000)          |       | K719*   | N/A        |          |          |          | K720*   | N/A     |         |         |
| <b>KFX 450 R Quad</b>           |       |         |            |          |          |          |         |         |         |         |
| Left                            | 07    |         | FA342R     | MD6137D  |          |          | FA84TT  | FA84R   | TBA     |         |
| Right                           |       |         | FA349R     |          | MD6137D  |          |         |         |         |         |
| <b>KLX 450 R (A8F)</b>          | 07    | FA185TT | FA185R■    | MD6264D* |          | MD6264C  | FA367TT | FA367R■ | MD6208D | MD6208C |
| KX 450 F (D6F/D7F)              | 06-07 | FA185TT | FA185R■    | MD6264D* |          | MD6264C  | FA367TT | FA367R■ | MD6208D | MD6208C |
| EN 500 A1-A3                    | 90-93 | FA85    | FA85HH     | MD4006LS |          |          | K709    |         |         |         |
| EN 500 B1-B2/C1-C9              | 94-04 | FA85    | FA85HH     | MD4124LS |          |          | K709    |         |         |         |
| H1 D/E/F                        | 73-75 | FA55    |            | MD4069LS |          |          | K710    |         |         |         |
| GPZ 500 "S" (EX 500 A1-A6)      | 87-93 | FA129   | FA129HH    | MD4016LS |          |          | K706    |         |         |         |
| GPZ 500 'S' (EX 500 B1-B5)      | 88-93 | FA67*   | FA67HH*    | MD4144LS | MD4144RS |          | K706    |         |         |         |
| GPZ 500 "S" (EX 500 D1-D7)      | 94-01 | FA129   | FA129HH    |          | MD4016RS |          | FA67/3  |         | MD4051  | MD4051C |
| GPZ 500 'S' (EX 500 E1-E10)     | 94-04 | FA141*  |            | MD4144LS | MD4144RS |          | FA67    |         | MD4051  | MD4051C |
| ER-5 (ER 500 A1/A2/A3/A4)       | 97-00 | FA129   | FA129HH    | MD4016LS |          |          | K706    |         |         |         |
| ER-5 (ER 500 C1/C3/C4/C5P)      | 01-07 | FA229   | FA229HH    | MD4016LS |          |          | K706    |         |         |         |
| KH 500 A8                       | 76    | FA33    |            | MD4052LS |          |          | K710    |         |         |         |
| KLE 500 B1                      | 05    | FA129   | FA129HH    | MD6093D  |          |          | FA67/3  |         | MD6082D |         |
| KLE 500 B1P/B6F/B7F             | 05-07 | FA129   | FA129HH    | MD6093D  |          |          | FA67/3  |         | MD6082D |         |
| KX 500 A1/A2                    | 83-84 | FA67    | FA67R      | N/A      |          |          | K602A   | K602AG  |         |         |
| KX 500 B1                       | 85    | FA67    | FA67R      | MD6036D  |          |          | K602A   | K602AG  |         |         |
| KX 500 B2                       | 86    | FA67    | FA67R      | MD6036D  |          |          | FA67    | FA67R   | MD6161D |         |
| KX 500 C1/D1                    | 87-88 | FA130   | FA130R     | MD6036D  |          |          | FA67    | FA67R   | MD6161D |         |
| KX 500 E1-E5                    | 89-93 | FA135TT | FA135R■    | MD6015D  |          | MD6015C  | FA152TT | FA152R■ | MD6024D | MD6024C |
| KX 500 E6/E7                    | 94-95 | FA185TT | FA185R■    | MD6015D* |          | MD6015C  | FA152TT | FA152R■ | MD6024D | MD6024C |
| KX 500 E8-E16                   | 96-04 | FA185TT | FA185R■    | MD6015D* |          | MD6015C  | FA131TT | FA131R■ | MD6024D | MD6024C |
| KLE 500 A1-A12                  | 91-04 | FA129   | FA129R     | MD6093D  |          |          | FA67/3  |         | MD6082D |         |
| Z 500 B1-B2                     | 79-80 | FA73*   |            | MD4047LS | MD4047RS |          | FA36    |         | MD4123  |         |
| KAF 540 C1 (Mule 2010)          |       | K719*   | N/A        |          |          |          | K720*   | N/A     |         |         |
| KAF 540 D1 (Mule 2020)          |       | K719*   | N/A        |          |          |          | K720*   | N/A     |         |         |
| KAF 540 E1 (Mule 2030)          |       | K719*   | N/A        |          |          |          | K720*   | N/A     |         |         |
| GPZ 550 D1                      | 82    | FA68*   | FA68HH*    | MD4010LS | MD4010RS |          | FA68    | FA68HH  | MD4010  |         |
| GPZ 550 H1/H2                   | 82-83 | FA68*   | FA68HH*    | MD4099LS | MD4099RS |          | FA68    | FA68HH  | MD4024  |         |
| GPZ 550 A1-A4 (ZX 550 A1-A4)    | 84-87 | FA85*   | FA85HH*    | MD4002LS | MD4002RS |          | FA85    | FA85HH  | MD4001  |         |
| GT 550 G1-G9                    | 83-01 | FA67*   | FA67HH*    | MD4006LS | MD4006RS |          | K709    |         |         |         |
| Z 550 A1                        | 80    | FA73*   |            | MD4047LS | MD4047RS |          | K709    |         |         |         |
| Z 550 A2/A3                     | 81-82 | FA68*   | FA68HH*    | MD4010LS | MD4010RS |          | K709    |         |         |         |
| Z 550 C1/C2 "LTD"               | 82-84 | FA68*   | FA68HH*    | MD4010LS | MD4010RS |          | K709    |         |         |         |
| ZR 550 A1/A2 (Z 550 F)          | 83-84 | FA67*   | FA67HH*    | MD4108LS | MD4108RS |          | K706    |         |         |         |
| ZR 550 B2/B3 "Zephyr"           | 91-93 | FA129*  | FA129HH*   | MD4008LS | MD4008RS | MD4008C* | FA141   |         | MD4009  | MD4009C |
| ZR 550 B4-B6 "Zephyr"           | 94-99 | FA129*  | FA129HH*   | MD4008LS | MD4008RS | MD4008C* | FA192   | FA192HH | MD4009  | MD4009C |
| GPX 600 R (ZX 600 C1-C7)        | 88-96 | FA129*  | FA129HH*   | MD4026LS | MD4026RS |          | FA129   | FA129HH | MD4027  |         |
| GPZ 600 R A1-A5A                | 85-89 | FA85*   | FA85HH*    | MD4028LS | MD4028RS |          | FA85    | FA85HH  | MD4015  |         |
| KLR 600 A1/B2/B1-B4/B6-B9       | 84-94 | FA67    | FA67R      | MD6080D  |          |          | K602A   | K602AG  |         |         |
| ZL 600 B1 "Eliminator"          | 95-97 | FA129   | FA129HH    |          | MD4008RS | MD4008C  | K709    |         |         |         |
| ZZR 600 (ZX 600 D1-D3)          | 90-93 | FA158*  | FA158HH*   | MD4141LS | MD4141RS | MD4141C* | FA129   | FA129HH | MD4007  |         |
| ZZR 600 (ZX 600 E1-E13)         | 93-05 | FA158*  | FA158HH*   | MD4153LS | MD4153RS | MD4153C* | FA192   | FA192HH | MD4009  | MD4009C |
| ZZR 600 (ZX 600 E6F)            | 06-07 | FA158*  | FA158HH*   | MD4153LS | MD4153RS | MD4153C* | FA192   | FA192HH | MD4009  | MD4009C |
| ZX-6R (ZX 600 F1-F3)            | 95-97 | FA158*  | FA158HH*   | MD4008LS | MD4008RS | MD4008C* | FA192   | FA192HH | MD4023  | MD4023C |
| ZX-6R (ZX 600 G1/G2/J1/J2)      | 98-01 | FA188*  | FA188HH*   | MD4136LS | MD4136RS | MD4136C* | FA192   | FA192HH | MD4138  | MD4138C |
| ZX-6R (ZX 636 A1P) "636cc"      | 02    | FA188*  | FA188HH*   | MD4136LS | MD4136RS | MD4136C* | FA192   | FA192HH | MD4138  | MD4138C |
| ZX6R (ZX 636 B1/B2)             | 03-04 |         | FA369/4HH* | MD4151LS | MD4151RS | MD4151C* | FA192   | FA192HH | MD4138  | MD4138C |
| ZX6R (ZX 636 C1/C6F)            | 05-06 |         | FA369/4HH* |          |          | MD4152C* | FA192   | FA192HH | MD4138  | MD4138C |
| ZX-6RR (ZX 600 K1/M1)           | 03-04 |         | FA369/4HH* | MD4151LS | MD4151RS | MD4151C* | FA192   | FA192HH | MD4138  | MD4138C |
| ZX-6RR (ZX 600 N1/N6F)          | 05-06 |         | FA369/4HH* |          |          | MD4152C* | FA192   | FA192HH | MD4138  | MD4138C |
| <b>ZX-6R (ZX 600 P7F)</b>       | 07    |         | FA417/4HH* |          |          | MD4152C* | FA192   | FA192HH |         | MD4138C |
| KAF 620 A1/A2/A3/A6 (Mule 2510) |       | K719*   | N/A        |          |          |          | K720*   | N/A     |         |         |
| KAF 620 B1/B2/B6 (Mule 2520)    |       | K719*   | N/A        |          |          |          | K720*   | N/A     |         |         |
| KAF 620 C1/C2/C3/C6 (Mule 2500) |       | K719*   | N/A        |          |          |          | K720*   | N/A     |         |         |

\*-2 Sets Required. ■ - Also available in MX-S race compound, see page 8. ✖ - Oversize and Supermoto disc available - see page 301.

**SAFETY WARNING:- DO NOT USE HH PADS ON REAR UNLESS ALSO USED ON FRONT TO AVOID BRAKE IMBALANCE.**

# JAPANESE Built Motorcycles



| Front/Avant/Vorn               |                   | Frente/Anteriore    |  |                                | Rear/Arrière/Hinten        |   | Posterior/Posteriore |   |
|--------------------------------|-------------------|---------------------|--|--------------------------------|----------------------------|---|----------------------|---|
| 1                              | 2                 | 3                   | 4  | 5                              | 6                          | 7 | 8                    | 9 |
| Sintered/HH Pads/Grooved shoes | Left/Gauche/Links | Right/Droite/Rechts | Contour Rotor Universal left and right fitment | Sintered/HH Pads/Grooved shoes | Contour Rotor Rear fitment |   |                      |   |

**KAWASAKI** contd.

|   |       |         |          |          |          |          |         |         |         |
|---|-------|---------|----------|----------|----------|----------|---------|---------|---------|
| KAF 620 E1/E2/E3/E4/E5 Mule 3010                        |       | K719*   | N/A      |          |          |          | K720*   | N/A     |         |
| KAF 620 F1/F2 Mule 3020                                 |       | K719*   | N/A      |          |          |          | K720*   | N/A     |         |
| KAF 620 G1/G2/G3/G4/G5 Mule 3000                        |       | K719*   | N/A      |          |          |          | K720*   | N/A     |         |
| KAF 620 H1/H2/H3 (Mule 3010 4x4)                        |       | K719*   |          |          |          |          | K720*   | N/A     |         |
| KAF 620 J1/K1/K6F (Mule 3010 Trans 4x4)                 | 05-06 | K719*   | N/A      |          |          |          | K720*   | N/A     |         |
| ER-6F (EX 650 A6F/A7F) Left                             | 06-07 | FA229   | FA229HH  |          |          | MD4159C  | FA192   | FA192HH | MD4138  |
| ER-6F (EX 650 A6F/A7F) Right                            |       | FA231   | FA231HH  |          |          | MD4156C  |         |         | MD4138C |
| ER-6F (ABS Model) Left                                  | 06-07 | FA229   | FA229HH  |          |          | MD4156AC | FA192   | FA192HH | MD4138  |
| ER-6F (ABS Model) Right                                 |       | FA231   | FA231HH  |          |          | MD4156C  |         |         | MD4138C |
| ER-6N (ER 650 A6F/B7F) Left                             | 06-07 | FA229   | FA229HH  |          |          | MD4159C  | FA192   | FA192HH | MD4138  |
| ER-6N (ER 650 A6F/B7F) Right                            |       | FA231   | FA231HH  |          |          | MD4159C  |         |         | MD4138C |
| ER-6N (ABS Model) Left                                  | 06-07 | FA229   | FA229HH  |          |          | MD4156AC | FA192   | FA192HH | MD4138  |
| ER-6N (ABS Model) Right                                 |       | FA231   | FA231HH  |          |          | MD4156C  |         |         | MD4138C |
| KLR 650 A1-A3   | 87-89 | FA130   | FA130R   | MD6042D* |          |          | FA67/3  |         | MD6082D |
| KL 650 B1-B3 "Tengai"                                   | 89-92 | FA129   | FA129R   | MD6081D  |          |          | FA67    | FA67R   | MD6082D |
| KLE 650 A7F Versys Left                                 | 07    | FA229   | FA229HH  |          |          | MD4159C  | FA192   | FA192HH |         |
| KLE 650 A7F Versys Right                                |       | FA231   | FA231HH  |          |          | MD4159C  |         |         | MD4138C |
| KLE 650 B7F Versys ABS Left                             | 07    | FA229   | FA229HH  |          |          | MD4156AC | FA192   | FA192HH |         |
| KLE 650 B7F Versys ABS Right                            |       | FA231   | FA231HH  |          |          | MD4156C  |         |         | MD4138C |
| KLR 650 C1-C10  | 95-04 | FA229   | FA229HH  | MD6081D  |          |          | FA67    | FA67R   | MD6082D |
| KLX 650 C1/C2/C3  | 93-97 | FA185TT | FA185R   | MD6086D  |          |          | FA152TT | FA152R  | MD6085D |
| KVF 650 A1/A2 Prairie Left                              | 02-03 | N/A     | FA342R   | MD6188D  |          |          | N/A     |         |         |
| KVF 650 A1/A2 Prairie Right                             |       | N/A     | FA349R   |          | MD6188D  |          |         |         |         |
| KVF 650 D1/D6F Brute Force 4x4 Left                     | 05-06 |         | FA342R   | MD6188D  |          |          | N/A     |         |         |
| KVF 650 D1/D6F Brute Force 4x4 Right                    |       |         | FA349R   |          | MD6188D  |          |         |         |         |
| KVF 650 E1/E6F Brute Force 4x4 Hardwoods Green HD Left  | 05    |         | FA342R   | MD6188D  |          |          | N/A     |         |         |
| KVF 650 E1/E6F Brute Force 4x4 Hardwoods Green HD Right |       |         | FA349R   |          | MD6188D  |          |         |         |         |
| W 650 (EJ 650-A1/C3/C4/C5/C6/C7)                        | 99-05 | FA231   | FA231HH  |          | MD4008RS | MD4008C  | K706    |         |         |
| Z 650 B1-B3   | 79-81 | FA33    |          | MD4052LS |          |          | K709    |         |         |
| Z 650 C1/C2   | 76-77 | FA33*   |          | MD4059LS | MD4059RS |          | FA37    |         | MD4062  |
| Z 650 C3  | 78    | FA73*   |          | MD4059LS | MD4059RS |          | FA36    |         | MD4086  |
| Z 650 D2/D3 (SR)  | 79-80 | FA73*   |          | MD4059LS | MD4059RS |          | FA36    |         | MD4063  |
| Z 650 F1  | 79    | FA73*   |          | MD4052LS | MD4052RS |          | K709    |         |         |
| Z 650 F2-F4   | 80-83 | FA68*   | FA68HH*  | MD4010LS | MD4010RS |          | K709    |         |         |
| KSV 700 A1/A2/A6F/B1/B2 /B6F(KFX 700) V-Force Left      | 04-06 |         | FA342R   | MD6137D  |          |          | N/A     |         |         |
| KSV 700 A1/A2/A6F/B1/B2 /B6F(KFX 700) V-Force Right     |       |         | FA349R   |          | MD6137D  |          |         |         |         |
| KVF 700 B1/B6F 4x4 (Prairie) Left                       | 04-06 |         | FA342R   | MD6188D  |          |          |         |         |         |
| KVF 700 B1/B6F 4x4 (Prairie) Right                      |       |         | FA349R   |          | MD6188D  |          |         |         |         |
| KVF 700 D1 Team Green Left                              | 05    |         | FA342R   | MD6188D  |          |          | N/A     |         |         |
| KVF 700 D1 Team Green Right                             |       |         | FA349R   |          | MD6188D  |          |         |         |         |
| Z 700 A1 "LTD"  | 84    | FA68*   | FA68HH*  | MD4010LS | MD4010RS |          | FA68    | FA68HH  | MD4010  |
| VN 700 A1 "Vulcan"                                      | 85    | FA85*   | FA85HH*  | MD4010LS | MD4010RS |          | K709    |         |         |
| ZN 700 A1/A2 "LTD"                                      | 84-85 | FA85*   | FA85HH*  | MD4067LS | MD4067RS |          | FA85    | FA85HH  | MD4068  |
| KVF 750 A1/A6F/B1/B6F Brute Force 4x4 Left              | 04-06 | FA135TT | FA135R   | MD6188D  |          |          | N/A     |         |         |
| KVF 750 A1/A6F/B1/B6F Brute Force 4x4 Right             |       | FA165TT | FA165R   |          | MD6188D  |          |         |         |         |
| Z 750 E1  | 80    | FA68*   | FA68HH*  | MD4010LS | MD4010RS |          | FA68    | FA68HH  | MD4010  |
| Z 750 H1/H2 "LTD"                                       | 80-81 | FA68*   | FA68HH*  | MD4010LS | MD4010RS |          | FA68    | FA68HH  | MD4010  |
| Z 750 L1-L4   | 81-84 | FA68*   | FA68HH*  | MD4010LS | MD4010RS |          | FA68    | FA68HH  | MD4010  |
| Z 750 Y1 "LTD"  | 82    | FA68*   | FA68HH*  | MD4043LS | MD4043RS |          | K709    |         |         |
| Z 750 B1/B2   | 77-78 | FA33    |          | N/A      |          |          | FA37    |         | N/A     |
| Z 750 D1  | 76    | FA33    |          | N/A      |          |          | FA37    |         | N/A     |
| Z 750 N1/N2 "Spectre"                                   | 82-83 | FA68*   | FA68HH*  | MD4010LS | MD4010RS |          | FA68    | FA68HH  | MD4010  |
| GPX 750 R (ZX 750 F1-F3)                                | 87-89 | FA129*  | FA129HH* | MD4071LS | MD4071RS |          | FA129   | FA129HH | MD4007  |
| GT 750 P1-P9  | 82-96 | FA68*   | FA68HH*  | MD4010LS | MD4010RS |          | FA68    | FA68HH  | MD4010  |
| GPZ 750 R1  | 82    | FA68*   | FA68HH*  | MD4010LS | MD4010RS |          | FA68    | FA68HH  | MD4010  |
| GPZ 750 A1-A5   | 83-87 | FA85*   | FA85HH*  | MD4028LS | MD4028RS |          | FA85    | FA85HH  | MD4019  |
| GPZ 750 E1/E2 "Turbo"                                   | 84-87 | FA85*   | FA85HH*  | MD4016LS | MD4016RS |          | FA85    | FA85HH  | MD4017  |
| GPZ 750 R G2/G3   | 85-86 | FA85*   | FA85HH*  | MD4016LS | MD4016RS |          | FA85    | FA85HH  | MD4017  |
| VN 750 A2-A5/A10  | 86-94 | FA85*   | FA85HH*  | MD4010LS | MD4010RS |          | K709    |         |         |
| Z 750 (ZR 750 L7F)                                      | 07    | FA142*  | FA142HH* |          |          | MD4159C* | FA174   | FA174HH | MD4157C |

\*-2 Sets Required. ■ - Also available in MX-S race compound, see page 8. ✖ - Oversize and Supermoto disc available - see page 301.

**SAFETY WARNING:- DO NOT USE HH PADS ON REAR UNLESS ALSO USED ON FRONT TO AVOID BRAKE IMBALANCE.**

**R** Suffix = High Durability Sintered Pad. **HH** Suffix = High Performance Sintered Pad. **G** Suffix = Grooved Shoe.  
**D** Suffix = Drilled Disc. **C** Suffix = Contoured Disc. **LS** Suffix = Left/Steel Disc. **RS** = Right/Steel Disc.

**BRAKE APPLICATIONS**

# JAPANESE Built Motorcycles

APPLICATIONS

BRAKE



| Front/Avant/Vorn               |                   | Frente/Anteriore    |  |                                | Rear/Arrière/Hinten        |   | Posterior/Posteriore |   |
|--------------------------------|-------------------|---------------------|--|--------------------------------|----------------------------|---|----------------------|---|
| 1                              | 2                 | 3                   | 4  | 5                              | 6                          | 7 | 8                    | 9 |
| Sintered/HH Pads/Grooved shoes | Left/Gauche/Links | Right/Droite/Rechts | Contour Rotor Universal left and right fitment | Sintered/HH Pads/Grooved shoes | Contour Rotor Rear fitment |   |                      |   |

**KAWASAKI** contd.

|                                     |       |       |        |            |          |          |          |       |         |         |         |
|-------------------------------------|-------|-------|--------|------------|----------|----------|----------|-------|---------|---------|---------|
| Z 750 ABS (ZR 750 M7F)              | Left  | 07    | FA142* | FA142HH*   |          |          | MD4156AC | FA174 | FA174HH |         | MD4157C |
|                                     | Right |       |        |            |          |          | MD4156C  |       |         |         |         |
| ZR 750 C1-C5 "Zephyr"               |       | 92-95 | FA129* | FA129HH*   | MD4008LS | MD4008RS | MD4008C* | FA129 | FA129HH | MD4007  |         |
| ZR 750 D1 "Zephyr"                  | Left  | 96-98 | FA229  | FA229HH    | MD4008LS |          | MD4008C  | FA129 | FA129HH | MD4007  |         |
|                                     | Right |       | FA231  | FA231HH    |          | MD4008RS | MD4008C  |       |         |         |         |
| ZR-7 (ZR 750 F1/F3/F5)              | Left  | 99-04 | FA229  | FA229HH    | MD4141LS |          | MD4141C  | FA231 | FA231HH | MD4142  |         |
|                                     | Right |       | FA231  | FA231HH    |          | MD4141RS | MD4141C  |       |         |         |         |
| ZR-7S (ZR 750 H1/H3)                | Left  | 01-04 | FA229  | FA229HH    | MD4141LS |          | MD4141C  | FA231 | FA231HH | MD4142  |         |
|                                     | Right |       | FA231  | FA231HH    |          | MD4141RS | MD4141C  |       |         |         |         |
| Z 750 S (ZR 750 K1/K6F)             | Left  | 05-07 | FA229  | FA229HH    | MD4141LS |          | MD4141C  | FA192 | FA192HH | MD4138  | MD4138C |
|                                     | Right |       | FA231  | FA231HH    |          | MD4141RS | MD4141C  |       |         |         |         |
| Z 750 (ZR 750 J1/J2/J6F)            | Left  | 04-06 | FA229  | FA229HH    | MD4141LS |          | MD4141C  | FA192 | FA192HH | MD4138  | MD4138C |
|                                     | Right |       | FA231  | FA231HH    |          | MD4141RS | MD4141C  |       |         |         |         |
| ZXR 750 H1/H2                       |       | 89-90 | FA158* | FA158HH*   | MD4012LS | MD4012RS | MD4012C* | FA161 | FA161HH | MD4013  | MD4013C |
| ZXR 750 K1/K2/J1/J2                 |       | 91-92 | FA158* | FA158HH*   | MD4022LS | MD4022RS | MD4022C* | FA161 | FA161HH | MD4013  | MD4013C |
| ZXR 750 M1/M2/L1-L3                 |       | 93-95 | FA158* | FA158HH*   | MD4022LS | MD4022RS | MD4022C* | FA161 | FA161HH | MD4013  | MD4013C |
| ZX7-R (ZX 750 P1/P2/P3/P4/P5/P6/P7) |       | 96-03 | FA188* | FA188HH*   | MD4022LS | MD4022RS | MD4022C* | FA161 | FA161HH | MD4013  | MD4013C |
| ZX7-RR (ZX 750 N1/N2)               |       | 96-99 | FA424* | FA424HH*   | MD4022LS | MD4022RS | MD4022C* | FA254 | FA254HH | MD4013  | MD4013C |
| VN 800 A1/A2/A3                     |       | 95-99 | FA85   | FA85HH     | MD4124LS |          |          | K709  |         |         |         |
| VN 800 B1-B10/B6F "Classic"         |       | 96-06 | FA229  | FA229HH    | MD4125LS |          |          | K709  |         |         |         |
| VN 800 C1/C2/E1/E2/E3 "Drifter"     |       | 99-04 | FA229  | FA229HH    | MD4125LS |          |          | FA231 | FA231HH | MD4148  |         |
| ZL 900 A1/A2 "Eliminator"           |       | 85-86 | FA85*  | FA85HH*    | MD4016LS | MD4016RS |          | FA85  | FA85HH  | MD4017  |         |
| GPZ 900 R A1-A6                     |       | 84-89 | FA85*  | FA85HH*    | MD4016LS | MD4016RS |          | FA85  | FA85HH  | MD4017  |         |
| GPZ 900 R A7/A8                     |       | 90-96 | FA158* | FA158HH*   | MD4008LS | MD4008RS | MD4008C* | FA129 | FA129HH | MD4015  |         |
| GPZ 900 R (ZX 900 A11)              |       | 98    | FA158* | FA158HH*   | MD4008LS | MD4008RS | MD4008C* | FA129 | FA129HH | MD4015  |         |
| GPZ 900 R (ZX 900 A12-A15)          |       | 99-02 | FA188* | FA188HH*   | TBA      | TBA      |          | FA129 | FA129HH | MD4015  |         |
| VN 900 A6F Classic                  |       | 06    | FA229  | FA229HH    | MD4158LS |          |          | FA231 | FA231HH | MD4085  |         |
| VN 900 B7F Classic (Spoke wheel)    |       | 07    | FA229  | FA229HH    | MD4158LS |          |          | FA231 | FA231HH | MD4085  |         |
| VN 900 C7F Custom (Cast wheel)      |       | 07    | FA229  | FA229HH    | MD4158LS |          |          | FA231 | FA231HH | MD4085  |         |
| Z 900 ZIA/ZIB                       |       | 74-76 | FA55*  |            | MD4069LS | MD4069RS |          | K713  |         |         |         |
| Z 900 A4                            |       | 77    | FA33*  |            | MD4052LS | MD4052RS |          | K713  |         |         |         |
| ZX9R (ZX 900 B1/B2)                 |       | 94-95 | FA158* | FA158HH*   | MD4022LS | MD4022RS | MD4022C* | FA192 | FA192HH | MD4013  | MD4013C |
| ZX9R (ZX 900 B3/B4)                 |       | 96-97 | FA188* | FA188HH*   | MD4022LS | MD4022RS | MD4022C* | FA192 | FA192HH | MD4013  | MD4013C |
| ZX9R (ZX 900 C1/C2)                 |       | 98-99 | FA188* | FA188HH*   | MD4136LS | MD4136RS | MD4136C* | FA192 | FA192HH | MD4138  | MD4138C |
| ZX9R (ZX 900 E1/E2)                 |       | 00-01 | FA188* | FA188HH*   | MD4012LS | MD4012RS | MD4012C* | FA192 | FA192HH | MD4138  | MD4138C |
| ZX9R (ZX 900 F1/F2)                 |       | 02-04 |        | FA347HH*   | MD4022LS | MD4022RS | MD4022C* | FA192 | FA192HH | MD4138  | MD4138C |
| KAF 950 A1/A2/A3 (Mule 2510 Diesel) |       |       | K719*  | N/A        |          |          |          | K720* | N/A     |         |         |
| KAF 950 B1/B2/B3 (Mule 3010 Diesel) |       |       | K719*  | N/A        |          |          |          | K720* | N/A     |         |         |
| GPZ 1000 RX (A1-A3)                 |       | 86-88 | FA85*  | FA85HH*    | MD4016LS | MD4016RS |          | FA85  | FA85HH  | MD4019  |         |
| KLV 1000 (LV 1000)                  | Left  | 04-05 | FA229  | FA229HH    | MD3088LS |          | MD3088C  | FA174 | FA174HH | MD6232D |         |
|                                     | Right |       | FA231  | FA231HH    |          | MD3088RS | MD3088C  |       |         |         |         |
| Z 1000 A1/A2                        |       | 77-78 | FA33*  |            | MD4064LS | MD4064RS |          | FA36  |         | MD4077  |         |
| Z 1000 A3/A4                        |       | 79-80 | FA73*  |            | MD4064LS | MD4064RS |          | FA36  |         | MD4077  |         |
| Z 1000 D1 (ZIR)                     |       | 78-   | FA33*  |            | MD4076LS | MD4076RS |          | FA36  |         | MD4077  |         |
| Z 1000 D3 (ZIR)                     |       | 79    | FA73*  |            | MD4076LS | MD4076RS |          | FA36  |         | MD4077  |         |
| Z 1000 ST (E1-E2 Shaft)             |       | 79-82 | FA62*  |            | MD4078LS | MD4078RS |          | FA36  |         | MD4090  |         |
| Z 1000 H1                           |       | 74    | FA33*  |            | MD4064LS | MD4064RS |          | FA36  |         | MD4077  |         |
| Z 1000 J1/J2                        |       | 81-82 | FA68*  | FA68HH*    | MD4006LS | MD4006RS |          | FA68  | FA68HH  | MD4054  |         |
| Z 1000 J3                           |       | 83    | FA68*  | FA68HH*    | MD4038LS | MD4038RS |          | FA68  | FA68HH  | MD4054  |         |
| Z 1000 K1 "LTD"                     |       | 83    | FA68*  | FA68HH*    | MD4006LS | MD4006RS |          | FA68  | FA68HH  | MD4054  |         |
| Z 1000 R2                           |       | 83    | FA68*  | FA68HH*    | MD4038LS | MD4038RS |          | FA68  | FA68HH  | MD4054  |         |
| Z 1000 (ZR 1000 A1/A2/A3/A6F)       |       | 03-06 |        | FA347HH*   | MD4154LS | MD4154RS | MD4154C* | FA192 | FA192HH | MD4138  | MD4138C |
| Z 1000 (ZR 1000 B7F)                |       | 07    |        | FA417/4HH* |          |          | MD4152C* | FA174 | FA174HH |         | MD4157C |
| Z 1000 ABS (ZR 1000 C7)             |       | 07    |        | FA417/4HH* |          |          | MD4152C* | FA174 | FA174HH |         | MD4157C |
| ZL 1000 A1                          |       | 87    | FA85*  | FA85HH*    | MD4016LS | MD4016RS |          | FA85  | FA85HH  | MD4017  |         |
| ZX 1000 B1-B3 (ZX-10)               |       | 88-90 | FA129* | FA129HH*   | MD4021LS | MD4021RS |          | FA129 | FA129HH | MD4015  |         |
| ZG 1000 A1-A7 (1000 GTR)            |       | 86-93 | FA85*  | FA85HH*    | MD4028LS | MD4028RS |          | FA85  | FA85HH  | MD4082  |         |
| ZG 1000 A9-A18 (1000 GTR)           |       | 94-03 | FA129* | FA129HH*   | MD4008LS | MD4008RS | MD4008C* | FA85  | FA85HH  | MD4082  |         |
| ZX 10 R (ZX 1000 C1/C2/D6F/D7F)     |       | 04-07 |        | FA369/4HH* |          |          | MD4152C* | FA192 | FA192HH |         | MD4138C |
| GPZ 1100 B1                         |       | 82    | FA68*  | FA68HH*    | MD4006LS | MD4006RS |          | FA68  | FA68HH  | MD4054  |         |

\*-2 Sets Required. ■ - Also available in MX-S race compound, see page 8. ✖ - Oversize and Supermoto disc available - see page 301.

**SAFETY WARNING:- DO NOT USE HH PADS ON REAR UNLESS ALSO USED ON FRONT TO AVOID BRAKE IMBALANCE.**

# JAPANESE Built Motorcycles



**KAWASAKI** contd.

|   |       | Front/Avant/Vorn |                                    |                   | Frente/Anteriore    |   | Rear/Arrière/Hinten |                                    | Posterior/Posteriore |                               |
|---|-------|------------------|------------------------------------|-------------------|---------------------|---|---------------------|------------------------------------|----------------------|-------------------------------|
|   |       | ①                | ②                                  | ③                 | ④                   | ⑤   | ⑥                   | ⑦                                  | ⑧                    | ⑨                             |
|   |       |                  | Sintered/HH Pads/<br>Grooved shoes | Left/Gauche/Links | Right/Droite/Rechts | Contour Rotor<br>Universal left and right fitment |                     | Sintered/HH Pads/<br>Grooved shoes |                      | Contour Rotor<br>Rear fitment |
| GPZ 1100 B2                                 | 83    | FA68*            | FA68HH*                            | MD4038LS          | MD4038RS            |   | FA68                | FA68HH                             | MD4054               |                               |
| Z 1100 D1/D2 "Spectre"                      | 82-83 | FA68*            | FA68HH*                            | MD4006LS          | MD4006RS            |   | FA68                | FA68HH                             | MD4054               |                               |
| GPZ 1100 A1-A3                              | 83-85 | FA85*            | FA85HH*                            | MD4016LS          | MD4016RS            |   | FA85                | FA85HH                             | MD4017               |                               |
| Z 1100 A1-A3                                | 81-83 | FA68*            | FA68HH*                            | MD4006LS          | MD4006RS            |   | FA68                | FA68HH                             | MD4054               |                               |
| Z 1100 R1 "Lawson Replica"                  | 84    | FA85*            | FA85HH*                            | MD4038LS          | MD4038RS            |   | FA68                | FA68HH                             | MD4054               |                               |
| ZR 1100 A1-A4 "Zephyr"                      | 92-95 | FA158*           | FA158HH*                           | MD4012LS          | MD4012RS            | MD4012C*  | FA129               | FA129HH                            | MD4027               |                               |
| ZR 1100 B1 "Zephyr" Left                    | 96-97 | FA229            | FA229HH                            | MD4012LS          |                     | MD4012C   | FA129               | FA129HH                            | MD4027               |                               |
| ZR 1100 B1 "Zephyr" Right                   |       | FA231            | FA231HH                            |                   | MD4012RS            | MD4012C   |                     |                                    |                      |                               |
| ZR 1100 B5 (Zephyr 1100 RS) Left            | 02    | FA229            | FA229HH                            | MD4012LS          |                     | MD4012C   | FA129               | FA129HH                            | MD4027               |                               |
| ZR 1100 B5 (Zephyr 1100 RS) Right           |       | FA231            | FA231HH                            |                   | MD4012RS            | MD4012C   |                     |                                    |                      |                               |
| ZRX 1100 (ZR 1100 C1/C2/C3/C4)              | 97-00 | FA188*           | FA188HH*                           | MD4012LS          | MD4012RS            | MD4012C*  | FA161               | FA161HH                            | MD4133               | MD4133C                       |
| ZZR 1100 (ZX 1100 C1-C3)                    | 90-92 | FA158*           | FA158HH*                           | MD4012LS          | MD4012RS            | MD4012C*  | FA129               | FA129HH                            | MD4015               |                               |
| ZZR 1100 (ZX 1100 D1-D9)                    | 93-01 | FA158*           | FA158HH*                           | MD4022LS          | MD4022RS            | MD4022C*  | FA161               | FA161HH                            | MD4014               |                               |
| GPZ 1100 E1/E2 Left                         | 95-97 | FA229            | FA229HH                            | MD4008LS          |                     | MD4008C   | FA192               | FA192HH                            | MD4130               |                               |
| GPZ 1100 E1/E2 Right                        |       | FA231            | FA231HH                            |                   | MD4008RS            | MD4008C   |                     |                                    |                      |                               |
| GPZ 1100 F1 (ABS Model) Left                | 96-98 | FA229            | FA229HH                            | MD4008LS          |                     |   | FA192               | FA192HH                            | MD4130               |                               |
| GPZ 1100 F1 (ABS Model) Right               |       | FA231            | FA231HH                            |                   | MD4132RS            |   |                     |                                    |                      |                               |
| ZX 12 R (ZX 1200 A1/A2/B1/B2)               | 00-03 | FA188*           | FA188HH*                           | MD4022LS          | MD4022RS            | MD4022C*  | FA161               | FA161HH                            | MD4023               | MD4023C                       |
| ZX 12R (ZX 1200 B3/B4/B6F)                  | 04-06 |                  | FA369/4HH*                         | MD4154LS          | MD4154RS            | MD4154C*  | FA161               | FA161HH                            | MD4023               | MD4023C                       |
| ZRX 1200 R (ZR 1200 A1/A2/A3/A4/A5/A6F)     | 01-06 | FA188*           | FA188HH*                           | MD4012LS          | MD4012RS            | MD4012C*  | FA161               | FA161HH                            | MD4133               | MD4133C                       |
| ZR 1200 S (ZR 1200 B1/B2/B3)                | 01-07 | FA188*           | FA188HH*                           | MD4012LS          | MD4012RS            | MD4012C*  | FA161               | FA161HH                            | MD4133               | MD4133C                       |
| ZZR 1200 C1H/C2H                            | 02-04 | FA158*           | FA158HH*                           | MD4022LS          | MD4022RS            | MD4022C*  | FA161               | FA161HH                            | MD4133               | MD4133C                       |
| Z 1300 A1-A5                                | 79-83 | FA62*            |                                    | MD4089LS          | MD4089RS            |   | FA36                |                                    | MD4090               |                               |
| ZG 1300 A1-A3                               | 84-86 | FA62*            |                                    | MD4089LS          | MD4089RS            |   | FA36                |                                    | MD4090               |                               |
| GTR 1400 (ZG 1400 A8F)                      | 07    |                  | FA417/4HH*                         |                   |                     | MD4155C*  | FA254               | FA254HH                            |                      | MD4157C                       |
| ZZR 1400 (ZX 1400 A6F/A7F)                  | 06-07 |                  | FA417/4HH*                         |                   |                     | MD4155C*  | FA254               | FA254HH                            |                      | MD4157C                       |
| ZZR 1400 ABS (ZX 1400 B7F)                  | 07    |                  | FA417/4HH                          |                   |                     | MD4155C*  | FA254               | FA254HH                            |                      | MD4157C                       |
| VN 1500 B2-B6 (VN 15 SE)                    | 88-92 | FA85             | FA85HH                             | MD4094LS          |                     |   | FA85                | FA85HH                             | MD4054               |                               |
| VN 1500 A6 (VN15)                           | 92    | FA85             | FA85HH                             | MD4124LS          |                     |   | FA85                | FA85HH                             | MD4054               |                               |
| VN 1500 C1/C2 (VN15)                        | 94-95 | FA85             | FA85HH                             | MD4124LS          |                     |   | FA85                | FA85HH                             | MD4128               |                               |
| VN 1500 D1/D2/E1/E2 "Classic"               | 96-99 | FA229            | FA229HH                            | MD4131LS          |                     |   | FA85                | FA85HH                             | MD4128               |                               |
| VN 1500 G1/G2 Left                          | 98-99 | FA229            | FA229HH                            | MD4150LS          |                     |   | FA85                | FA85HH                             | MD4147               |                               |
| VN 1500 G1/G2 "Classic Tourer" Right        |       | FA231            | FA231HH                            |                   | MD4150RS            |   |                     |                                    |                      |                               |
| VN 1500 J1/J2/R1/R2/R3 Drifter              | 99-04 | FA229            | FA229HH                            | MD4125LS          |                     |   | FA231               | FA231HH                            | MD4148               |                               |
| VN 1500 N1/N2/N3 "Classic Fi"               | 00-04 | FA229            | FA229HH                            | MD4125LS          |                     |   | FA231               | FA231HH                            | MD4148               |                               |
| VN 1500 L1/L2/L3/L4 Left                    | 00-03 | FA229            | FA229HH                            | MD4150LS          |                     |   | FA231               | FA231HH                            | MD4147               |                               |
| VN 1500 L1/L2/L3/L4 "Nomad Fi" Right        |       | FA231            | FA231HH                            |                   | MD4150RS            |   |                     |                                    |                      |                               |
| VN 1500 P1/P2 'Mean Streak'                 | 02-04 | FA188*           | FA188HH*                           | MD4022LS          | MD4022RS            | MD4022C*  | FA231               | FA231HH                            | MD4146               |                               |
| VN 1600 A1/A2/A3/A6F Left                   | 03-07 | FA229            | FA229HH                            | MD4158LS          |                     |   | FA231               | FA231HH                            | MD4146               |                               |
| VN 1600 A1/A2/A3/A6F Classic Right          |       | FA231            | FA231HH                            |                   | MD4158RS            |   |                     |                                    |                      |                               |
| VN 1600 B1 Mean Streak                      | 04    | FA188*           | FA188HH*                           | MD4022LS          | MD4022RS            | MD4022C*  | FA231               | FA231HH                            | MD4146               |                               |
| VN 1600 B2H/B6F/B7F (Mean Streak)           | 05-07 |                  | FA369/4HH*                         | MD4022LS          | MD4022RS            | MD4022C*  | FA231               | FA231HH                            | MD4146               |                               |
| VN 1600 D1H/D6F Classic Left                | 05-07 | FA229            | FA229HH                            | MD4158LS          |                     |   | FA231               | FA231HH                            | MD4146               |                               |
| VN 1600 D1H/D6F Classic Tourer Right        |       | FA231            | FA231HH                            |                   | MD4158RS            |   |                     |                                    |                      |                               |
| VN 2000 A1/A2/A6F                           | 04-07 | FA158*           | FA158HH*                           | MD4158LS          |                     |   | FA231               | FA231HH                            | TBA                  |                               |
|   |       |                  |                                    |                   | MD4158RS            |   |                     |                                    |                      |                               |
| <b>SUZUKI</b>                               |       |                  |                                    |                   |                     |   |                     |                                    |                      |                               |
| A 50  | 71-76 | S603             |                                    |                   |                     |   | S603                |                                    |                      |                               |
| AD 50 T/Tune/V-Tune                         | 88    | FA83TT           |                                    | TBA               |                     |   | S632                |                                    |                      |                               |
| AE 50 R                                     |       | FA83TT           | FA83HH                             | TBA               |                     |   | S632                |                                    |                      |                               |
| AE 50 L/N/T "Style"                         | 90-96 | S632             |                                    |                   |                     |   | S632                |                                    |                      |                               |
| AH 50 N "Address" (CA1GA)                   | 92-95 | S624             |                                    |                   |                     |   | S624                |                                    |                      |                               |
| AJ 50 ZZ/RS Sepia                           | 92-   | FA83TT           | FA83HH                             | TBA               |                     |   | S624                |                                    |                      |                               |
| AP 50                                       | 75-78 | S603             |                                    |                   |                     |   | S603                |                                    |                      |                               |
| AP 50 R/S/T/V/W                             | 96-02 | FA193            | FA193HH                            | MD937D            |                     |   | S624                |                                    |                      |                               |
| AY 50 VNVV/WWW/WRW/K1/K2/K3/K4 "Katana"     | 97-04 | FA193            | FA193HH                            | MD938D            |                     |   | S624                |                                    |                      |                               |
| AY 50 WRX/WX/WRY/WY/WRK1/WRK2               |       |                  |                                    |                   |                     |   |                     |                                    |                      |                               |
| AY 50 WRK3/WRK4 "Katana" (Grimeca caliper)  | 99-04 | FA193            | FA193HH                            | MD938D            |                     |   | FA115               | FA115HH                            | MD940D               |                               |
| AY 50 WRK1/WRK2/WRK3/WRK4/AK5 (AJP Caliper) | 01-05 | FA115            | FA15HH                             | MD938D            |                     |   | FA115               | FA115HH                            | MD940D               |                               |

\*-2 Sets Required. ■ - Also available in MX-S race compound, see page 8. ✖ - Oversize and Supermoto disc available - see page 301.

**SAFETY WARNING:- DO NOT USE HH PADS ON REAR UNLESS ALSO USED ON FRONT TO AVOID BRAKE IMBALANCE.**

**R** Suffix = High Durability Sintered Pad. **HH** Suffix = High Performance Sintered Pad. **G** Suffix = Grooved Shoe.  
**D** Suffix = Drilled Disc. **C** Suffix = Contoured Disc. **LS** Suffix = Left/Steel Disc. **RS** = Right/Steel Disc.

**BRAKE APPLICATIONS**

# JAPANESE Built Motorcycles

APPLICATIONS

BRAKE



| Front/Avant/Vorn               |                   |                     | Frente/Anteriere                               |                                |                            | Rear/Arrière/Hinten |   |   | Posterior/Posteriore |  |  |
|--------------------------------|-------------------|---------------------|--|--------------------------------|----------------------------|---------------------|---|---|----------------------|--|--|
| 1                              | 2                 | 3                   | 4  | 5                              | 6                          | 7                   | 8 | 9 |                      |  |  |
| Sintered/HH Pads/Grooved shoes | Left/Gauche/Links | Right/Droite/Rechts | Contour Rotor Universal left and right fitment | Sintered/HH Pads/Grooved shoes | Contour Rotor Rear fitment |                     |   |   |                      |  |  |

SUZUKI contd.

|  |       |          |         |          |  |         |        |         |
|--|-------|----------|---------|----------|--|---------|--------|---------|
| AZ 50 XL/LX/UX/Y/LY/LUY/K2/UK2 (LETS II) |       | S632     |         |          |  | S624    |        |         |
| AZ 50 RY/RK2 (ZZ "Inch Up Sport")        | 00-02 | FA396    |         | TBA      |  | TBA     |        |         |
| CL 50 D "Suzi/Love"                      | 83    | S614     |         |          |  | S613    |        |         |
| CP 50 CHF (CA14C)                        | 85    | S624     |         |          |  | S624    |        |         |
| CP 50 C                                  |       | FA83TT   | FA83HH  | TBA      |  | S631    |        |         |
| CR 50 DC                                 |       | FA83TT   | FA83HH  | TBA      |  | S632    |        |         |
| CS 50 Z/D "Roadie"                       | 83-84 | S613     |         |          |  | S613    |        |         |
| CX 50 DF (CA15A)                         | 85    | S614     |         |          |  | S614    |        |         |
| F 50                                     | 71-73 | S603     |         |          |  | S603    |        |         |
| FR 50                                    | 74-81 | S603     |         |          |  | S603    |        |         |
| FS 50 T/X "Snip"                         | 81-82 | S614     |         |          |  | S614    |        |         |
| FZ 50 N/X/Z "Suzy"                       | 80-82 | S601     |         |          |  | S601    |        |         |
| GS 50 K5 (NA41A)                         | 05    | S604     |         |          |  | S604    |        |         |
| GT 50 KB/KEN                             | 77-80 | FA39     |         | N/A      |  | S603    |        |         |
| JR 50 (All models)                       | 78-07 | S613     | S613G   |          |  | S613    | S613G  |         |
| LT 50 G/H/J/K/L/X/Y/K1                   | 86-02 | None     |         |          |  | S613    | S613G  |         |
| LT-A 50 K2/K3/K4/K5 Quadmaster           | 02-05 | S614*    | S614G*  |          |  | S604    | S604G  |         |
| LT-Z 50 K6/K7 Quadspport                 | 06-07 | S614*    | S614G*  |          |  | S604    | S604G  |         |
| OR 50 ET                                 | 80    | FA67     |         | N/A      |  | S604    |        |         |
| RB 50 H "GSXR 50"                        | 87    | FA67     |         | MD3010LS |  | S604    |        |         |
| RG 50 EW                                 |       | FA67     |         | N/A      |  | S601    |        |         |
| RM 50 C/N/T                              | 78-80 | S603     | S603G   |          |  | S603    | S603G  |         |
| RM 50 X/Z                                | 81-82 | S604     | S604G   |          |  | S604    | S604G  |         |
| RMX 50                                   |       | FA115    | FA115R  | N/A      |  | FA115   | FA115R | N/A     |
| TR 50 SW/SX "Street Magic"               | 98-00 | FA396    |         | MD911D   |  | 897     |        |         |
| TS 50 W                                  |       | S617     |         |          |  | S601    |        |         |
| TS 50 KN                                 | 79    | S603     | S603G   |          |  | S603    | S603G  |         |
| TS 50 ERKT/X/Z/D                         | 80-83 | S603     | S603G   |          |  | S604    | S604G  |         |
| TS 50 XKE/XKG/XKH/XKJ/XKM/XKR            | 84-02 | S617     | S617G   |          |  | S601    |        |         |
| UF 50 Y "Estillete"                      | 00-02 | FA115    | FA115HH | MD938D   |  | S624    |        |         |
| UR 50 W/Y/K1/K2/K3 (CA1MA/B) Verde       | 99-03 | S632     |         |          |  | S624    |        |         |
| UX 50 WX/MY "Zillion"                    | 99-02 | FA193    | FA193HH | MD938D   |  | S624    |        |         |
| X5K3/BK3/DK3/DBK3 (CZ41A) Choinori       | 03    | S632     |         |          |  | S632    |        |         |
| ZR 50 KEN/KEX "X1"                       | 79-83 | FA39     |         | N/A      |  | S603    |        |         |
| ZR 50 SLKX                               | 81    | FA67     | FA67HH  | N/A      |  | S604    |        |         |
| ZR 50 SKX/SKE/SKH                        | 83-87 | FA67     | FA67HH  | N/A      |  | S604    |        |         |
| RM 60 K3                                 | 03    | K715     | K715G   |          |  | K715    | K715G  |         |
| RM 65 K3/K4/K5                           | 03-05 | FA302TT  | FA302R  | MD6166D  |  | FA54TT  | FA54R  | MD6166D |
| FR 70                                    | 74-76 | S603     |         |          |  | S603    |        |         |
| AH 80 Address                            | 92-94 | FA83TT   | FA83HH  | MD939D   |  | S624    |        |         |
| CP 80 CHF                                | 85-93 | S624     |         |          |  | S624    |        |         |
| CS 80 CD                                 | 83    | S601     |         |          |  | S601    |        |         |
| DS 80 T/X/Z/D/F/G/H/J/K/L/MN/P/R/S       |       |          |         |          |  |         |        |         |
| /T/V/W/X/Y                               | 80-00 | S604     | S604G   |          |  | S604    | S604G  |         |
| FR 80 M/B/N/X/Z/D                        | 76-83 | S603     |         |          |  | S603    |        |         |
| JR 80 K1/K2/K3/K4/K5/K6/K7               | 01-07 | S604     | S604G   |          |  | S604    | S604G  |         |
| LT 80 L/M/N/P/R/S/T/V/W/X/Y/K1-K6        | 87-06 | S614*    | S614G*  |          |  | S618    | S618G  |         |
| RM 80 B/C/N                              | 77-79 | S603     | S603G   |          |  | S603    | S603G  |         |
| RM 80 XT/XX                              | 80-81 | S604     | S604G   |          |  | S604    | S604G  |         |
| RM 80 XZ/XD/XE/XF                        | 82-85 | S615     | S615G   |          |  | Y502    | Y502G  |         |
| RM 80 HD/HF                              | 83-85 | S602     | S602G   |          |  | S604    | S604G  |         |
| RM 80 XG/XH/XJ/XK (RC12A)                | 86-89 | FA83/2TT | FA83/2R | MD6018D  |  | Y502    | Y502G  |         |
| RM 80 XL/XM/XN/XP/XR/XS (RC12A)          | 90-95 | FA83TT   | FA83R   | MD6018D  |  | MD6018C |        |         |
| RM 80 T/V/W/X/Y/K1                       | 96-01 | FA230TT  | FA230R  | MD6018D  |  | MD6018C |        |         |
| RM 85 K2/LK2/K3/LK3/K4/LK4               | 02-04 | FA230TT  | FA230R  | MD6018D  |  | MD6018C |        |         |
| RM 85 K5/LK5/K6/LK6/K7/LK7               | 05-07 | FA258TT  | FA258R  | MD6030D  |  | MD6030C |        |         |
| Oversize Disc available                  |       |          |         | OSS6030C |  |         |        |         |
| FB 90 K1 (BD42A)                         | 01    | S602     |         |          |  | S602    |        |         |
| LT-Z 90 K7 Quadspport                    | 07    | S604*    | S604G*  |          |  | TBA     |        |         |
| TS 90 R/J                                | 71-73 | S603     | S603G   |          |  | S602    | S602G  |         |

\*-2 Sets Required. ■ - Also available in MX-S race compound, see page 8. ✖ - Oversize and Supermoto disc available - see page 301.

**SAFETY WARNING:- DO NOT USE HH PADS ON REAR UNLESS ALSO USED ON FRONT TO AVOID BRAKE IMBALANCE.**



# JAPANESE Built Motorcycles



SUZUKI contd.

|                                     |       | Front/Avant/Vorn |                                    |                   | Frente/Anteriere    |  | Rear/Arrière/Hinten |                                    | Posterior/Posteriore |                               |         |
|-------------------------------------|-------|------------------|------------------------------------|-------------------|---------------------|--|---------------------|------------------------------------|----------------------|-------------------------------|---------|
|                                     |       | ①                | ②                                  | ③                 | ④                   | ⑤  | ⑥                   | ⑦                                  | ⑧                    | ⑨                             |         |
|                                     |       |                  | Sintered/HH Pads/<br>Grooved shoes | Left/Gauche/Links | Right/Droite/Rechts | Contour Rotor<br>Universal left<br>and right fitment |                     | Sintered/HH Pads/<br>Grooved shoes |                      | Contour Rotor<br>Rear fitment |         |
| ASS 100                             | 69-71 |                  | S602                               |                   |                     |  |                     | S603                               |                      |                               |         |
| ACC 100                             | 70-72 |                  | S602                               |                   |                     |  |                     | S602                               |                      |                               |         |
| A 100 "All Models"                  | 74-80 |                  | S603                               |                   |                     |  |                     | S603                               |                      |                               |         |
| AH 100 Address                      | 92-94 |                  | FA83TT                             | FA83HH            | MD939D              |  |                     | S624                               |                      |                               |         |
| AH 100 P "Address" (CE12A)          | 95-96 |                  | FA83TT                             | FA83HH            | MD912D              |  |                     | S624                               |                      |                               |         |
| GP 100 C/N/X/DED                    | 78-87 |                  | FA46                               |                   | N/A                 |  |                     | S603                               |                      |                               |         |
| GP 100 UN/UX/UD/UL                  | 79-92 |                  | S602                               |                   |                     |  |                     | S603                               |                      |                               |         |
| RM 100 A/B/C                        | 76-78 |                  | S603                               | S603G             |                     |  |                     | S602                               | S602G                |                               |         |
| RM 100 N/T/X                        | 79-81 |                  | S603                               | S603G             |                     |  |                     | S617                               | S617G                |                               |         |
| RM 100 K3                           | 03    |                  | FA258TT                            | FA258R            | MD6186DX            | MD6186C  | FA84TT              | FA84R                              | MD6187D              | MD6187C                       |         |
| TS 100 K/L/M                        | 73-75 |                  | S603                               | S603G             |                     |  |                     | S602                               | S602G                |                               |         |
| TS 100 A/B/C/ERN/ERT/ERX            | 75-81 |                  | S602                               | S602G             |                     |  |                     | S602                               | S602G                |                               |         |
| TS 100 ERZ/ERH                      | 82-87 |                  | S602                               | S602G             |                     |  |                     | S604                               | S604G                |                               |         |
| DR-Z 110 K3/K4/K5                   | 03-05 |                  | K715                               | K715G             |                     |  |                     | S603                               | S603G                |                               |         |
| 110cc "Smash"                       | 03    |                  | S603                               |                   |                     |  |                     | S603                               |                      |                               |         |
| FX 110 Shogun                       |       |                  | S603                               |                   |                     |  |                     | S603                               |                      |                               |         |
| UG 110 W/SW/Y/SY/SK1 Hokuto/Address | 98-02 |                  | FA396                              |                   | MD911D              |  |                     | 897                                |                      |                               |         |
| Shogun-R FD-112                     | 04    |                  | FA197                              | FA197HH           | N/A                 |  |                     | S603                               |                      |                               |         |
| B 120                               | 71-77 |                  | S602                               |                   |                     |  |                     | S602                               |                      |                               |         |
| AN 125 S/T/V/W/X                    | 95-00 |                  | FA396                              |                   | MD911D              |  |                     | S624                               |                      |                               |         |
| CS 125 D                            | 83    |                  | S603                               |                   |                     |  |                     | S603                               |                      |                               |         |
| DF 125                              |       |                  | FA54TT                             | FA54R             | MD6073D             |  |                     | S602                               |                      |                               |         |
| DR 125 SZ/SD/SE                     | 82-84 |                  | S602                               | S602G             |                     |  |                     | S602                               | S602G                |                               |         |
| DR 125 SF/SH/SJ                     | 85-94 |                  | FA54TT                             | FA54R             | MD6073D             |  |                     | S602                               | S602G                |                               |         |
| DR 125 SEX/SEY                      | 99-01 |                  | FA54TT                             | FA54R             | MD6073D             |  |                     | S602                               | S602G                |                               |         |
| DR-Z 125 K3/K4/K5/K6/K7             | 03-07 |                  | S604                               |                   |                     |  |                     | S604                               |                      |                               |         |
| DR-Z 125 LK3/LK4/LK5/LK6/LK7        | 03-07 |                  | FA230TT                            | FA230R            | MD6212D             |  |                     | S604                               |                      |                               |         |
| EN 125-2                            | 05    |                  | FA135TT                            |                   | N/A                 |  |                     | S602                               |                      |                               |         |
| EN 125-2A                           | 05    |                  | FA135TT                            |                   | N/A                 |  |                     | S602                               |                      |                               |         |
| FX 125                              |       |                  | FA197                              | FA197HH           | TBA                 |  |                     | S603                               |                      |                               |         |
| GN 125 Z/M/R/V/W/X/Y/K1 (NF41A)     | 94-01 |                  | FA67                               | FA67HH            | N/A                 |  |                     | S602                               |                      |                               |         |
| GP 125 C/N/X/D                      | 78-84 |                  | FA56                               |                   | N/A                 |  |                     | S602                               |                      |                               |         |
| GS 125 Z/D                          | 82-84 |                  | S602                               |                   |                     |  |                     | S602                               |                      |                               |         |
| GS 125 ESZ                          | 82    |                  | FA67                               | FA67HH            | N/A                 |  |                     | S602                               |                      |                               |         |
| GS 125 ESD/ESF/ESK/ESM              | 83-94 |                  | FA93                               |                   | N/A                 |  |                     | S602                               |                      |                               |         |
| GS 125 ESR/ESX                      | 95-00 |                  | FA67                               | FA67HH            | N/A                 |  |                     | S602                               |                      |                               |         |
| GT 125 L/M/A/B                      | 76-79 |                  | FA55                               |                   |                     | N/A  |                     | S602                               |                      |                               |         |
| GT 125 C/EC/N                       | 80-82 |                  | FA38                               |                   |                     | N/A  |                     | S602                               |                      |                               |         |
| GX 125 (SJ 125)                     | 03    |                  | FA93                               |                   | N/A                 |  |                     | S602                               |                      |                               |         |
| GZ 125 W/X/Y/K1/K2/K3/K4/K5         |       |                  |                                    |                   |                     |  |                     |                                    |                      |                               |         |
| /K6/K7 "Marauder"                   | 98-07 |                  | FA106TT                            |                   | N/A                 |  |                     | S602                               |                      |                               |         |
| LT 125 D                            | 83    |                  | None                               |                   |                     |  |                     | S621                               | S621G                |                               |         |
| LT 125 E                            | 84    |                  | None                               |                   |                     |  |                     | S605                               | S605G                |                               |         |
| LT 125 F/G/H                        | 85-87 |                  | None                               |                   |                     |  |                     | S621                               | S621G                |                               |         |
| RG 125 UCG/UCH/UCJ/JBUJ "Gamma"     | 85-91 |                  | FA110                              |                   | MD3048LS            |  |                     | S602                               |                      |                               |         |
| RG 125 UN "Wolf"                    | 92-94 |                  | FA129                              | FA129HH           |                     | MD3045RS   | FA157               |                                    | MD3059               |                               |         |
| RG 125 FUN/FUP/FUR "Gamma" NF13A    | 92-96 |                  | FA158                              | FA158HH           |                     | MD3045RS   | FA157               |                                    | MD3059               |                               |         |
| RM 125 M/A/B/C                      | 75-78 |                  | S602                               | S602G             |                     |  |                     | S602                               | S602G                |                               |         |
| RM 125 N/T                          | 79-80 |                  | S602                               | S602G             |                     |  |                     | S617                               | S617G                |                               |         |
| RM 125 X/Z/D                        | 81-83 |                  | S602                               | S602G             |                     |  |                     | S616                               | S616G                |                               |         |
| RM 125 E                            | 84    |                  | S622                               | S622G             |                     |  |                     | S616                               | S616G                |                               |         |
| RM 125 F/G                          | 85-86 |                  | FA106TT                            | FA106R            | MD6163D             |  |                     | S616                               | S616G                |                               |         |
| RM 125 H                            | 87    |                  | FA135TT                            | FA135R            | MD6163D             |  |                     | S616                               | S616G                |                               |         |
| RM 125 J                            | 88    |                  | FA135TT                            | FA135R            | MD6163D             |  |                     | →                                  | FA84/3R              | MD6014D                       | MD6014C |
| RM 125 K/L/M                        | 89-91 |                  | FA135TT                            | FA135R            | MD6017DX            | MD6017C  | FA152TT             | FA152R                             | MD6014D              | MD6014C                       |         |
| RM 125 N/P/R/S (RF14A)              | 92-95 |                  | FA135TT                            | FA135R            | MD6017DX            | MD6017C  | FA152/2TT           | FA152/2R                           | MD6014D              | MD6014C                       |         |
| RM 125 T/V/W                        | 96-98 |                  | FA185TT                            | FA185R            | MD6017DX            | MD6017C  | FA131TT             | FA131R                             | MD6014D              | MD6014C                       |         |
| RM 125 X/Y/K1/K2/K3/K4/K5/K6/K7     | 99-07 |                  | FA185TT                            | FA185R            | MD6017DX            | MD6017C  | FA131TT             | FA131R                             | MD6157D              | MD6157C                       |         |
| RV 125 K                            | 73    |                  | S603                               | S603G             |                     |  |                     | S602                               | S602G                |                               |         |
| RV 125 L/M/A                        | 74-76 |                  | S602                               | S602G             |                     |  |                     | S602                               | S602G                |                               |         |

\*-2 Sets Required. ■ - Also available in MX-S race compound, see page 8. ✕ - Oversize and Supermoto disc available - see page 301.

**SAFETY WARNING:- DO NOT USE HH PADS ON REAR UNLESS ALSO USED ON FRONT TO AVOID BRAKE IMBALANCE.**

R Suffix = High Durability Sintered Pad. HH Suffix = High Performance Sintered Pad. G Suffix = Grooved Shoe.  
D Suffix = Drilled Disc. C Suffix = Contoured Disc. LS Suffix = Left/Steel Disc. RS = Right/Steel Disc.

BRAKE APPLICATIONS

# JAPANESE Built Motorcycles

APPLICATIONS

BRAKE



| Front/Avant/Vorn                   |                   | Frente/Anteriore    |  |                                    | Rear/Arrière/Hinten           |   | Posterior/Posteriore |   |
|------------------------------------|-------------------|---------------------|--|------------------------------------|-------------------------------|---|----------------------|---|
| 1                                  | 2                 | 3                   | 4  | 5                                  | 6                             | 7 | 8                    | 9 |
| Sintered/HH Pads/<br>Grooved shoes | Left/Gauche/Links | Right/Droite/Rechts | Contour Rotor<br>Universal left<br>and right fitment | Sintered/HH Pads/<br>Grooved shoes | Contour Rotor<br>Rear fitment |   |                      |   |

SUZUKI contd.

|   |       |         |          |          |          |           |           |         |        |         |
|---|-------|---------|----------|----------|----------|-----------|-----------|---------|--------|---------|
| RV 125 K2/K3/K4/K5/K6 "Van-Van"   | 02-06 | FA231   | FA231HH  | MD6281D  |          | S603      |           |         |        |         |
| T 125/125 II/125 R "Stinger"  | 69-71 | S602    |          |          |          | S602      |           |         |        |         |
| TF 125 Farm Bike (All models)   | 78-05 | S602    | S602G    |          |          | S602      | S602G     |         |        |         |
| TS 125 K  | 72    | S603    | S603G    |          |          | S602      | S602G     |         |        |         |
| TS 125 LM/A/B/C/CZ/ERN/ERT/ERX  | 73-81 | S602    | S602G    |          |          | S602      | S602G     |         |        |         |
| TS 125 ERZ  | 82    | S602    | S602G    |          |          | S604      | S604G     |         |        |         |
| TS 125 N  | 84    | S602    | S602G    |          |          | S602      | S602G     |         |        |         |
| TS 125 XE   | 84    | S602    | S602G    |          |          | S627      | S627G     |         |        |         |
| TS 125 XUF/XUG/XUH/XUJ  | 86-90 | FA54TT  | FA54R■   | MD6073D  |          | S627      | S627G     |         |        |         |
| TS 125 RK/RL/RM/RN/RP/RR (SF15A)  | 90-96 | FA135TT | FA135R■  | MD6109D  |          | FA152TT   | FA152R■   | MD6038D |        |         |
| TU 125 X Super Classic  | 99    | FA106TT |          | N/A      |          | S602      |           |         |        |         |
| UC 125 X/Y "Epicuro"  | 99-02 | FA396   |          | MD934D   |          | S635      |           |         |        |         |
| UE 125/150 CTK1   | 01-03 | FA83TT  | FA83HH   | TBA      |          | S624      |           |         |        |         |
| UH 125 K2/K3/K4/K5/K6 Burgman   | 02-06 | FA181TT | FA181HH  | MD976D   |          | FA266     | FA266HH   | MD975D  |        |         |
| Parking brake   |       | S602    |          |          |          |           |           |         |        |         |
| UH 125 K7 Burgman   | 07    | FA388   | FA388HH  | TBA      |          | FA228     | FA228HH   | TBA     |        |         |
| UZ 125 K5/GK5 (CF46A) (V 125 G)   | 05    | FA396   |          | TBA      |          | TBA       |           |         |        |         |
| VL 125 Y/K1-K7 "Intruder"   | 00-07 | FA106TT |          | N/A      |          | S602      |           |         |        |         |
| X4 125  |       | FA67    | FA67HH   | N/A      |          | S602      |           |         |        |         |
| LT 160 EK/EL/EM/EN  | 89-92 | S624*   | S624G*   |          |          | S605      | S605G     |         |        |         |
| LT-F 160 LM/N/P/R/S/T/V/W/X/Y/K1-K3   | 90-03 | S624*   | S624G*   |          |          | S605      | S605G     |         |        |         |
| LT 160 K3/K4 QuadSport  | 03-04 | S624*   | S624G*   |          |          | S605      | S605G     |         |        |         |
| PE 175 C/N  | 78-79 | S602    | S602G    |          |          | S602      | S602G     |         |        |         |
| PE 175 T/X  | 80-81 | S602    | S602G    |          |          | S619      | S619G     |         |        |         |
| PE 175 Z  | 82    | S618    | S618G    |          |          | S619      | S619G     |         |        |         |
| GT 185 K/L/M/A/B/C/EC   | 73-79 | FA55    |          | N/A      |          | S602      |           |         |        |         |
| LT 185 E/F  | 84-85 | None    |          |          |          | S605      | S605G     |         |        |         |
| TS 185 K  | 73    | S603    | S603G    |          |          | S602      | S602G     |         |        |         |
| TS 185 L/M/B/C/ERN/ERT/ERX  | 74-81 | S602    | S602G    |          |          | S602      | S602G     |         |        |         |
| DF 200 EV/EW/EY (SH42A)   | 98-00 | FA54TT  | FA54R■   | MD6073D  |          | S602      | S602G     |         |        |         |
| DR 200 G/H/J  | 86-89 | FA54TT  | FA54R■   | MD6073D  |          | S602      | S602G     |         |        |         |
| DR 200 SEP/SER/SES/SEV/SEW/SEX/SEY (SH42A)  | 93-99 | FA54TT  | FA54R■   | MD6073D  |          | S602      | S602G     |         |        |         |
| DR 200 SEK1-SEK6  | 01-05 | FA54TT  | FA54R■   | MD6073D  |          | S602      | S602G     |         |        |         |
| DR 200 SE Trojan  |       | FA54TT  | FA54R■   | MD6073D  |          | S602      | S602G     |         |        |         |
| GT 200 EN/EX "X5"   | 79-82 | FA38    |          | N/A      |          | S602      |           |         |        |         |
| RV 200 K2/K3  | 02-03 | FA231   | FA231HH  | MD6281D  |          | S603      |           |         |        |         |
| SB 200 N/X  | 79-81 | S605    |          |          |          | S602      |           |         |        |         |
| SX 200 R/R-2/RJ/RM (SH41A)  | 90-91 | FA54TT  | FA54R■   | MD6073D  |          | S605      | S605G     |         |        |         |
| TS 200 RK/RL/RM/RN/RP/RR  | 89-94 | FA135TT | FA135R■  | MD6109D  |          | FA152TT   | FA152R■   | MD6038D |        |         |
| UH 200 K7 Burgman   | 07    | FA388   | FA388HH  | TBA      |          | FA228     | FA228HH   | TBA     |        |         |
| LT 230 GEF/GEG  | 85-86 | S625*   | S625G*   |          |          | S605      | S605G     |         |        |         |
| LT-F 230 G/H  | 86-87 | S625*   | S625G*   |          |          | S605      | S605G     |         |        |         |
| LT-F4WDX H/J/K/L/M/N/P/R/S/T/V/W  | 87-98 | S633*   | S633G*   |          |          | S634      | S634G     |         |        |         |
| 250 SBK2 (LX 250 L)   | 02    | FA185TT | FA185R■  | MD6240D* | MD6240C  | FA131TT   | FA131R■   | MD6105D |        |         |
| AN 250 W/X/Y "Burgman"  | 98-02 | FA283*  | FA283HH* | MD929D   |          | FA323/3   | FA323/3HH | MD930D  |        |         |
| AN 250 K1/K2 Burgman  | 01-02 | FA283*  | FA283HH* | MD929D   |          | FA411     | FA411HH   | MD930D  |        |         |
| AN 250 K6 Skywave 250 S   | 06    | TBA     |          |          | TBA      | TBA       |           | TBA     |        |         |
| DR 250 SL/SM/SN/SEP/SER/SES   | 90-95 | FA135TT | FA135R■  | MD6040D  |          | FA152TT   | FA152R■   | MD6038D |        |         |
| DR 250 RS/RLS/RT/RV/RLV/RLW/<br>/RW/RY (SJ45A/DOHC)                                     | 95-00 | FA185TT | FA185R■  | MD6017D* | MD6017C  | FA152/2TT | FA152/2R■ | MD6110D |        |         |
| DR 250 RXT/RXLT/RXV/RXLV/RXW/RXLW<br>/RXGW/RXGLW/RXY/RXGY<br>(Dejbel 250 XC/GPS (SJ45A) | 96-98 | FA185TT | FA185R■  | MD6017D* | MD6017C  | FA152TT   | FA152R■   | MD6110D |        |         |
| DR-Z 250 K1-K7  | 01-07 | FA185TT | FA185R■  | MD6017D* | MD6017C  | FA152/2TT | FA152/2R■ | MD6110D |        |         |
| GN 250 F/J/M/R/T (NJ41A)  | 85-97 | FA51    |          | MD3014LS |          | S602      |           |         |        |         |
| GT 250 K/L/M/N/A/B/C  | 73-78 | FA55    |          |          | MD3014RS | S609      |           |         |        |         |
| GT 250 EN/ET/EX "X7"  | 78-81 | FA38    |          |          | N/A      | S606      |           |         |        |         |
| GS 250 TT/TX  | 80-81 | FA51    |          | MD3014LS |          | S606      |           |         |        |         |
| GSF 250 N/Z/M/P/NP/ZP/R/NR Bandit (GJ74A)   | 92-96 | FA129   | FA129HH  |          | MD3006RS | MD3006C   | FA63      | FA63HH  | MD3002 | MD3002C |
| GSF 250 VS/S Bandit   | 97    | FA229   | FA229HH  | MD3006LS |          | MD3006C   | FA63      | FA63HH  | MD3002 | MD3002C |

\*-2 Sets Required. ■ - Also available in MX-S race compound, see page 8. ✕ - Oversize and Supermoto disc available - see page 301.

**SAFETY WARNING:- DO NOT USE HH PADS ON REAR UNLESS ALSO USED ON FRONT TO AVOID BRAKE IMBALANCE.**

# JAPANESE Built Motorcycles



SUZUKI contd.

|  |          | Front/Avant/Vorn |                                    |                       | Frente/Anteriere        |  | Rear/Arrière/Hinten |                                    | Posterior/Posteriore |                               |
|--|----------|------------------|------------------------------------|-----------------------|-------------------------|--|---------------------|------------------------------------|----------------------|-------------------------------|
|  |          | 1                | 2                                  | 3                     | 4                       | 5  | 6                   | 7                                  | 8                    | 9                             |
|  |          |                  | Sintered/HH Pads/<br>Grooved shoes | Left/Gauche/Links<br> | Right/Droite/Rechts<br> | Contour Rotor<br>Universal left<br>and right fitment |                     | Sintered/HH Pads/<br>Grooved shoes |                      | Contour Rotor<br>Rear fitment |
| GSX 250 ET/EX/EZ                             | 80-82    | FA51             |                                    | MD3014LS              |                         |  | S606                |                                    |                      |                               |
| GSX 250 RCH/H (GJ72A)                        | 87       | FA103*           | FA103HH*                           | MD3074LS              | MD3074RS                |  | FA63                | FA63HH                             | MD3064               |                               |
| GSX 250 SSM Katana (GJ76A)                   | 91       | FA129            | FA129HH                            | MD3006LS              |                         | MD3006C  | FA63                | FA63HH                             | MD3002               |                               |
| GSX 250 FXK2 (ZR 250 C)                      | 02       | FA231            | FA231HH                            |                       |                         | MD4008C  | FA67                | FA67HH                             | MD4051               |                               |
| GSXR 250 CJ (GJ72A)                          | 88       | FA103*           | FA103HH*                           | MD3074LS              | MD3074RS                |  | FA63                | FA63HH                             | MD3081               |                               |
| GSXR 250 CK (GJ72A)                          | 89       | FA103*           | FA103HH*                           | MD3074LS              | MD3074RS                |  | FA63                | FA63HH                             | MD3081               |                               |
| GSXR 250 RK (GJ73A)                          | 89       | FA158*           | FA158HH*                           | MD3003LS              | MD3003RS                | MD3003C*   | FA63                | FA63HH                             | TBA                  |                               |
| LT-F 250 J/K/L/M/N/P/R/S/T/V/W/X/Y/K1        | 88-01    | S628*            | S628G*                             |                       |                         |  | S629                | S629G                              |                      |                               |
| LT-F 250 FX/FY/FK1/FK2                       | 99-02    | S628*            | S628G*                             |                       |                         |  | S629                | S629G                              |                      |                               |
| LT-F 250 K2/K3/K4/K5/K6 Ozark                | 02-06    | FA54TT*          | FA54R*                             | MD6207D               | MD6207D                 |  | S636                | S636G                              |                      |                               |
| LT 250 EFF/EFG                               | 85-86    | S625*            | S625G*                             |                       |                         |  | S634                | S634G                              |                      |                               |
| LT 250 RH/RJ/RK/RL                           | 87-90    | FA128TT*         | FA128R*                            | MD6020D               | MD6020D                 |  | FA137TT             | FA137R                             | MD6021D              |                               |
| LT-Z 250 K4/K5/K6/K7 QuadSport               | 04-07    | FA84TT*          | FA84R*                             | MD6207D               | MD6207D                 |  | S636                | S636G                              |                      |                               |
| LT-F4WD H/J/K/L/M/N/P/R/S/T/V/W              | 87-98    | S628*            | S628G*                             |                       |                         |  | S629                | S629G                              |                      |                               |
| PE 250 B/C/N                                 | 77-79    | S605             | S605G                              |                       |                         |  | S605                | S605G                              |                      |                               |
| PE 250 T/X/Z                                 | 80-82    | S605             | S605G                              |                       |                         |  | S605                | S605G                              |                      |                               |
| RM 250 A/B/C                                 | 76-78    | S602             | S602G                              |                       |                         |  | S605                | S605G                              |                      |                               |
| RM 250 N                                     | 79       | S605             | S605G                              |                       |                         |  | S620                | S620G                              |                      |                               |
| RM 250 T                                     | 80       | S618             | S618G                              |                       |                         |  | S620                | S620G                              |                      |                               |
| RM 250 X/Z                                   | 81-82    | S621             | S621G                              |                       |                         |  | S616                | S616G                              |                      |                               |
| RM 250 D                                     | 83       | S622             | S622G                              |                       |                         |  | S616                | S616G                              |                      |                               |
| RM 250 E                                     | 84       | S622             | S622G                              |                       |                         |  | S602                | S602G                              |                      |                               |
| RM 250 F/G                                   | 85-86    | FA106TT          | FA106R                             | MD6163D               |                         |  | S602                | S602G                              |                      |                               |
| RM 250 H/J                                   | 87-88    | FA135TT          | FA135R                             | MD6163D               |                         |  | →                   | FA84/3R                            | MD6014D              |                               |
| RM 250 K/L/M                                 | 89-91    | FA135TT          | FA135R                             | MD6017D               |                         | MD6017C  | FA152TT             | FA152R                             | MD6014D              |                               |
| RM 250 N/P/R/S (RJ16A)                       | 92-95    | FA135TT          | FA135R                             | MD6017D               |                         | MD6017C  | FA152/2TT           | FA152/2R                           | MD6014D              |                               |
| RM 250 T/V/W                                 | 96-98    | FA185TT          | FA185R                             | MD6017D               |                         | MD6017C  | FA131TT             | FA131R                             | MD6014D              |                               |
| RM 250 X/Y/K1/K2/K3/K4/K5/K6/K7              | 99-07    | FA185TT          | FA185R                             | MD6017D               |                         | MD6017C  | FA131TT             | FA131R                             | MD6157D              |                               |
| RMX 250 K/M/N/P                              | 89-93    | FA135TT          | FA135R                             | MD6017D               |                         | MD6017C  | FA152TT             | FA152R                             | MD6014D              |                               |
| RMX 250 R/S                                  | 94-95    | FA135TT          | FA135R                             | MD6017D               |                         | MD6017C  | FA152/2TT           | FA152/2R                           | MD6014D              |                               |
| RMX 250 T/V/W                                | 96-98    | FA185TT          | FA185R                             | MD6017D               |                         | MD6017C  | FA152TT             | FA152R                             | MD6014D              |                               |
| RMX 250 ST/SV/SW/SX (SJ14A)                  | 96-99    | FA185TT          | FA185R                             | MD6017D               |                         | MD6017C  | FA131TT             | FA131R                             | MD6014D              |                               |
| RMX 250 SN/SR/SS (SJ13A)                     | 95-97    | FA135TT          | FA135R                             | MD6017D               |                         | MD6017C  | FA152/2TT           | FA152/2R                           | MD6014D              |                               |
| RM-Z 250 K4/K5/K6                            | 04-06    | FA185TT          | FA185R                             | MD6213D               |                         | MD6213C  | FA367TT             | FA367R                             | MD6208D              |                               |
| RM-Z 250 K7                                  | 07       | FA185TT          | FA185R                             | MD6254D               |                         | MD6254C  | FA367TT             | FA367R                             | MD6255D              |                               |
| RG 250 WD "Gamma"                            | 83       | FA63             | FA63HH                             | MD3014LS              |                         |  | FA63                | FA63HH                             | MD3064               |                               |
| RG 250 WE                                    | 84       | FA102            |                                    | MD3014LS              |                         |  | FA63                |                                    | MD3064               |                               |
| RG 250 FG/CH/FCH/FH "Gamma" (GJ21B)          | 85-88    | FA102*           |                                    | N/A                   | N/A                     |  | FA63                |                                    | MD3064               |                               |
| RGV 250 J                                    | 88       | FA158*           | FA158HH*                           | MD3003LS              | MD3003RS                | MD3003C*   | FA63                | FA63HH                             | MD3081               |                               |
| RGV 250 K/L (VJ21A)                          | 89-90    | FA158*           | FA158HH*                           | MD3003LS              | MD3003RS                | MD3003C*   | FA63                | FA63HH                             | MD3081               |                               |
| RGV 250 M/N/P/R/S (VJ22A)                    | 91-95    | FA158*           | FA158HH*                           | MD3045LS              | MD3045RS                |  | FA141               |                                    | MD3059               |                               |
| RGV 250 T (RGVR 250 SP VJ23A)                | 96       | FA180*           | FA180HH*                           | MD3082LS              | MD3082RS                |  | FA141               |                                    | MD3059               |                               |
| SW-1 (NJ45A)                                 | 92       | FA129            | FA129HH                            | N/A                   |                         |  | S606                |                                    |                      |                               |
| T 20 Super Six                               | 66-68    | S608             |                                    |                       |                         |  | S609                |                                    |                      |                               |
| T 250 II/R/J                                 | 70-72    | S608             |                                    |                       |                         |  | S609                |                                    |                      |                               |
| TS 250 L/M/A/B/C/ERN/ERT/ERX                 | 74-82    | S605             | S605G                              |                       |                         |  | S605                | S605G                              |                      |                               |
| TS 250 XE/XG/XH/XJ/XK                        | 85-89    | FA54TT           | FA54R                              | MD6075D               |                         |  | S627                | S627G                              |                      |                               |
| TU 250 S/T/XS/XT/X-<br>(NJ47A 100001-115972) | 92-97    | FA106TT          |                                    | N/A                   |                         |  | S602                |                                    |                      |                               |
| TU 250 XV/XW                                 | 97-00    | FA106TT          |                                    | N/A                   |                         |  | S602                |                                    |                      |                               |
| TU 250 TX/X/XTY (NJ47A-115-) Volty           | 99-00    | FA231            | FA231HH                            | N/A                   |                         |  | S602                |                                    |                      |                               |
| TU 250 GY/GBK1 Grass Tracker                 |          |                  |                                    |                       |                         |  |                     |                                    |                      |                               |
| - Big Boy (NJ47A-117/123)                    | 00-01    | FA229            | FA229HH                            | N/A                   |                         |  | S602                |                                    |                      |                               |
| TV 250 J/K/AK/L (VJ21A) Wolf                 | 88-90    | FA158            | FA158HH                            |                       | MD3007RS                | MD3007C  | FA63                | FA63HH                             | MD3081               |                               |
| VL 250 Y/K1/K5 "Intruder"                    | 00-01/05 | FA106TT          |                                    |                       | N/A                     |  | S602                |                                    |                      |                               |
| LT-F 300 J/K                                 | 88-89    | S625*            | S625G*                             |                       |                         |  | S634                | S634G                              |                      |                               |
| LT-F 300 FX/FY/FK1                           | 99-01    | S633*            | S633G*                             |                       |                         |  | S634                | S634G                              |                      |                               |
| LT-F 300 FK2 Left                            | 02       | FA135TT          | FA135R                             | MD6206D               |                         |  | S634                | S634G                              |                      |                               |
| LT-F 300 FK2 Right                           |          | FA165TT          | FA165R                             |                       | MD6206D                 |  |                     |                                    |                      |                               |
| LT-F 4WD XH/J/K/L/M/N/P/R/S/T/V/W            | 87-98    | S633*            | S633G*                             |                       |                         |  | S634                | S634G                              |                      |                               |

\*-2 Sets Required. ■ - Also available in MX-S race compound, see page 8. ✕ - Oversize and Supermoto disc available - see page 301.

**SAFETY WARNING:- DO NOT USE HH PADS ON REAR UNLESS ALSO USED ON FRONT TO AVOID BRAKE IMBALANCE.**

R Suffix = High Durability Sintered Pad. HH Suffix = High Performance Sintered Pad. G Suffix = Grooved Shoe.  
D Suffix = Drilled Disc. C Suffix = Contoured Disc. LS Suffix = Left/Steel Disc. RS = Right/Steel Disc.

BRAKE APPLICATIONS

# JAPANESE Built Motorcycles

APPLICATIONS

BRAKE



| Front/Avant/Vorn                   |                   | Frente/Anteriere    |  |                                    | Rear/Arrière/Hinten           |   | Posterior/Posteriore |   |
|------------------------------------|-------------------|---------------------|--|------------------------------------|-------------------------------|---|----------------------|---|
| 1                                  | 2                 | 3                   | 4  | 5                                  | 6                             | 7 | 8                    | 9 |
| Sintered/HH Pads/<br>Grooved shoes | Left/Gauche/Links | Right/Droite/Rechts | Contour Rotor<br>Universal left<br>and right fitment | Sintered/HH Pads/<br>Grooved shoes | Contour Rotor<br>Rear fitment |   |                      |   |

SUZUKI contd.

|  |       |         |          |          |          |          |           |           |         |
|--|-------|---------|----------|----------|----------|----------|-----------|-----------|---------|
| RL 325                                     |       | S603    | S603G    |          |          | S602     | S602G     |           |         |
| DR 350 SL/SM/SN/SP/SER/SES (SK42A)         | 91-99 | FA135TT | FA135R■  | MD6040D  |          | FA152TT  | FA152R■   | MD6038D   |         |
| DR 350 SET/SEV                             | 96-97 | FA135TT | FA135R■  | MD6040D  |          | FA152TT  | FA152R■   | MD6110D   |         |
| DR 350 SEW/SEX                             | 98-99 | FA185TT | FA185R■  | MD6017D* |          | MD6017C  | FA152/2TT | FA152/2R■ | MD6110D |
| SG 350 N "Goose"                           | 92    | FA158   | FA158HH  |          | MD3080RS |          | FA63      | FA63HH    | MD3081  |
| T 350 1/2/R/J                              | 69-72 | S608    |          |          |          |          | S609      |           |         |
| SP 370 C/N                                 | 77-80 | S605    | S605G    |          |          |          | S605      | S605G     |         |
| GT 380 J                                   | 72    | S608    |          |          |          |          | S609      |           |         |
| GT 380 K/L/M/A/B                           | 73-77 | FA55    |          |          | MD3014RS |          | S609      |           |         |
| AN 400 X/Y "Burgman"                       | 99-00 | FA283*  | FA283HH* | MD929D   |          |          | FA323/3   | FA323/3HH | MD930D  |
| AN 400 K1-K6                               | 01-06 | FA283*  | FA283HH* | MD994D   |          |          | FA411     | FA411HH   | N/A     |
| AN 400 K1/K2                               | 01-02 | FA283*  | FA283HH* | MD929D   |          |          | FA411     | FA411HH   | N/A     |
| AN 400 K3-K6                               | 03-06 | FA283*  | FA283HH* | MD994D   |          |          | FA411     | FA411HH   | N/A     |
| AN 400 K7 Burgman                          |       | Left 07 | FA228    | FA228HH  | MD994D   |          | FA412     | FA412HH   | MD9109D |
|  |       | Right   | FA197    | FA197HH  |          | MD994D   |           |           |         |
| DR 400 ST/SX                               | 79-81 | S605    | S605G    |          |          |          | S605      | S605G     |         |
| DR-Z 400 SY/EY/Y/SEK1/EK1/K1/SK2/EK2/K2/K3 |       |         |          |          |          |          |           |           |         |
| /SK3/EK3/K4/SK4/EK4/SK5/EK5/K5/EK5/EK6     |       |         |          |          |          |          |           |           |         |
| /SK6/K6/SK7/EK7K7                          | 00-07 | FA185TT | FA185R■  | MD6017D* |          | MD6017C  | FA131TT   | FA131R■   | MD6014D |
| DR-Z 400 SMK5/SMK6/SMK7                    | 05-07 | FA185TT | FA185R■  | MD6247D  |          | MD6247C  | FA131TT   | FA131R■   | MD6157D |
| GN 400 TT                                  | 80    | FA51    |          | MD3014LS |          |          | S606      |           |         |
| GS 400 B/C                                 | 77-78 | FA35    |          | MD3014LS |          |          | S609      |           |         |
| GS 400 LX                                  | 81    | FA51    |          | MD3014LS |          |          | S606      |           |         |
| GS 400 TX                                  | 81    | FA51    |          | MD3014LS |          |          | S609      |           |         |
| GSF 400 K/NK/Z/V/M/VZM/P/NP/NVP            |       |         |          |          |          |          |           |           |         |
| /NVP/NR "Bandit" (GK75A)                   | 89-94 | FA158*  | FA158HH* | MD3003LS | MD3003RS | MD3003C* | FA63      | FA63HH    | MD3002  |
| GSF 400 M/N/P Bandit                       | 91-95 | FA129   | FA129HH  | MD3006LS |          | MD3006C  | FA63      | FA63HH    | MD3002  |
| GSF 400 SVS/V-VVZ-V Bandit (GK7AA)         | 95-97 | FA158*  | FA158HH* | MD3003LS | MD3003RS | MD3003C* | FA63      | FA63HH    | MD3084  |
| GSR 400 K6                                 | 06    | FA158*  | FA158HH* | MD3092LS | MD3092RS | MD3092C* | FA419     | FA419HH   | MD3093  |
| GSX 400 ET/EX/EZ                           | 81-83 | FA51    |          | MD3014LS |          |          | S606      |           |         |
| GSX 400 FW/FWS/FWS-2                       |       | FA63*   | FA63HH*  | MD3024LS | MD3024RS |          | FA63      | FA63HH    | MD3025  |
| GSX 400 R2 (GK 71B)                        |       | FA102*  |          | N/A      | N/A      |          | FA63      |           | MD3064  |
| GSX 400 R3 (GK 71F)                        |       | FA103*  | FA103HH* | MD3001LS | MD3001RS |          | FA63      | FA63HH    | MD3064  |
| GSX 400 FX/FZ/FD                           | 81-83 | FA67*   | FA67HH*  | MD3066LS | MD3066RS |          | FA36      |           | MD3025  |
| GSX 400 FJ/FK/FAK/FL (GK74A)               | 88-90 | FA146*  | FA146HH* | MD3003LS | MD3003RS | MD3003C* | FA63      | FA63HH    | MD3002  |
| GSX 400 X/XA/XS "Impulse"                  |       | FA103*  | FA103HH* | MD3001LS | MD3001RS |          | FA63      | FA63HH    | MD3064  |
| GSX 400 SSN (GK77A) Katana                 | 92    | FA158*  | FA158HH* | MD3003LS | MD3003RS | MD3003C* | FA63      | FA63HH    | MD3002  |
| GSX 400 R/S/T/ZR/ZS/ZT (GK79A)             |       |         |          |          |          |          |           |           |         |
| "Impulse Type S"                           | 94-96 | FA142*  | FA142HH* | MD3003LS | MD3003RS | MD3003C* | FA63      | FA63HH    | MD3002  |
| GSX 400 X (GK79A) Impulse                  | 99    | FA244*  | FA244HH* | MD3003LS | MD3003RS | MD3003C* | FA63      | FA63HH    | MD3002  |
| GSX 400 FSV/FSK1 (GK7B) Inazuma            | 00    | FA244*  | FA244HH* | MD3003LS | MD3003RS | MD3003C* | FA63      | FA63HH    | MD3008  |
| GSXR 400 H                                 | 87    | FA103*  | FA103HH* | MD3001LS | MD3001RS |          | FA63      | FA63HH    | MD3069  |
| GSXR 400 J/RR/RAK (GK73A)                  | 88-90 | FA158*  | FA158HH* | MD3003LS | MD3003RS | MD3003C* | FA63      | FA63HH    | MD3081  |
| GSXR 400 RL/RM/RN/RP/RS (GK76A)            | 90-95 | FA145*  | FA145HH* | MD3045LS | MD3045RS |          | FA63      | FA63HH    | MD3081  |
| LT-A 400 FK2-FK7 Eiger 4WD                 | 02-07 | FA54TT* | FA54R*■  | MD6195D  | MD6195D  |          | S606      | S606G     |         |
| LT-A 400 K2/K3/K4 Eiger                    | 02-04 | FA54TT* | FA54R*■  | MD6195D  | MD6195D  |          | S606      | S606G     |         |
| LT-F 400 FK2/FK3/FK4/FK5/FK6               |       |         |          |          |          |          |           |           |         |
| /FK7 (Eiger 4WD)                           | 02-07 | FA54TT* | FA54R*■  | MD6195D  | MD6195D  |          | S606      | S606G     |         |
| LT-F 400 K2/K3/K4 Eiger                    | 02-04 | FA54TT* | FA54R*■  | MD6195D  | MD6195D  |          | S606      | S606G     |         |
| LT-Z 400 K3/K4/K5/K6/K7                    | 03-07 | FA84TT* | FA84R*■  | MD6210D  | MD6210D  |          | FA137TT   | FA137R    | MD6211D |
| PE 400 T/X                                 | 79-81 | S605    | S605G    |          |          |          | S605      | S605G     |         |
| RF 400 RP/RR/VR/RT/RVT/RV-V (GK78A)        | 93-97 | FA142*  | FA142HH* | MD3003LS | MD3003RS | MD3003C* | FA63      | FA63HH    | MD3008  |
| RG 400 EWF/EW-2G/EWH Walter Wolf           |       |         |          |          |          |          |           |           |         |
| (Type 1 & 2)                               | 85-87 | FA103*  | FA103HH* | MD3070LS | MD3070RS |          | FA63      | FA63HH    | MD3064  |
| RM 400 C                                   | 78    | S602    | S602G    |          |          |          | S605      | S605G     |         |
| RM 400 N                                   | 79    | S605    | S605G    |          |          |          | S620      | S620G     |         |
| RM 400 T                                   | 80    | S618    | S618G    |          |          |          | S620      | S620G     |         |
| SP 400 T                                   | 80    | S605    | S605G    |          |          |          | S605      | S605G     |         |
| VS 400 VR/FR/VTR/FTR/V-T/F-T "Intruder"    | 94-   | FA103   | FA103HH  |          | MD3032RS |          | S626      |           |         |
| GS 425 EN                                  | 78-80 | FA35    |          | MD3014LS |          |          | S606      |           |         |

\*-2 Sets Required. ■ - Also available in MX-S race compound, see page 8. ✖ - Oversize and Supermoto disc available - see page 301.

**SAFETY WARNING:- DO NOT USE HH PADS ON REAR UNLESS ALSO USED ON FRONT TO AVOID BRAKE IMBALANCE.**

# JAPANESE Built Motorcycles



SUZUKI contd.

|  |       | Front/Avant/Vorn |                                    |                       | Frente/Anteriore        |  | Rear/Arrière/Hinten |                                    | Posterior/Posteriore |                               |
|--|-------|------------------|------------------------------------|-----------------------|-------------------------|--|---------------------|------------------------------------|----------------------|-------------------------------|
|  |       | 1                | 2                                  | 3                     | 4                       | 5  | 6                   | 7                                  | 8                    | 9                             |
|  |       |                  | Sintered/HH Pads/<br>Grooved shoes | Left/Gauche/Links<br> | Right/Droite/Rechts<br> | Contour Rotor<br>Universal left<br>and right fitment |                     | Sintered/HH Pads/<br>Grooved shoes |                      | Contour Rotor<br>Rear fitment |
| RM-Z 450 K5/K6/K7                          | 05-07 | FA185TT          | FA185R                             | MD6254D*              |                         | MD6254C  | FA367TT             | FA367R                             | MD6255D              | MD6255C                       |
| GS 450 ET/EG/EJ                            | 80-88 | FA51             |                                    | MD3014LS              |                         |  | S606                |                                    |                      |                               |
| LT-A 450 XK7                               | 07    | FA413TT          | FA413R                             | MD6261D               |                         |  | N/A                 |                                    |                      |                               |
|  | Left  | FA414TT          | FA414R                             |                       | MD6261D                 |  |                     |                                    |                      |                               |
| LT-R 450 K6/K7                             | 06-07 | FA135TT          | FA135R                             | MD6277D               |                         |  | FA137TT             | FA137R                             | MD6278D              |                               |
|  | Right | FA165TT          | FA165R                             |                       | MD6277D                 |  |                     |                                    |                      |                               |
| RM 465 X/Z                                 | 81-82 | S621             | S621G                              |                       |                         |  | S602                | S602G                              |                      |                               |
| DR 500 X/Z/D                               | 81-83 | S602             | S602G                              |                       |                         |  | S605                | S605G                              |                      |                               |
| DR 500 S/A                                 | 84-88 | S605             | S605G                              |                       |                         |  | S605                | S605G                              |                      |                               |
| GS 500 EK/EL/EM/EN/EP/ER/ES (GM51A)        | 89-95 | FA129            | FA129HH                            |                       | MD3006RS                | MD3006C  | FA63                | FA63HH                             | MD3002               | MD3002C                       |
| GS 500 ET/EV/EW/EX/EY/K1/K2/K3             | 96-03 | FA231            | FA231HH                            |                       | MD3006RS                | MD3006C  | FA63                | FA63HH                             | MD3002               | MD3002C                       |
| GS 500 FK4/K4/FK5/K5/FK6/K6/FK7/K7         | 04-07 | FA231            | FA231HH                            |                       | MD3006RS                | MD3006C  | FA63                | FA63HH                             | MD3002               | MD3002C                       |
| T 500 1/2/3/R/J/K/L/M                      | 68-74 | S612             |                                    |                       |                         |  | S609                |                                    |                      |                               |
| GT 500 A/B                                 | 75-78 | FA55             |                                    |                       | MD3019RS                |  | S609                |                                    |                      |                               |
| RE 5 M/A                                   | 75-77 | FA55*            |                                    | MD3019LS              | MD3019RS                |  | S634                |                                    |                      |                               |
| RG 500 G/CH                                | 85-87 | FA103*           | FA103HH*                           | MD3070LS              | MD3070RS                |  | FA63                | FA63HH                             | MD3064               |                               |
| RM 500 D/E                                 | 83-84 | S622             | S622G                              |                       |                         |  | S602                | S602G                              |                      |                               |
| LT 500 RL                                  | 90    | FA128TT*         | FA128R*                            | MD6022D               | MD6022D                 |  | FA137TT             | FA137R                             | MD6023D              |                               |
| LT-A 500 FY/FK1                            | 00-01 | FA135TT          | FA135R                             | MD6145D               |                         |  | S634                | S634G                              |                      |                               |
|  | Right | FA165TT          | FA165R                             |                       | MD6145D                 |  |                     |                                    |                      |                               |
| LT-A 500 FK2 Vision 4WD                    | 02    | FA54TT*          | FA54R*                             | MD6195D               | MD6195D                 |  | FA317TT             | FA317R                             | MD6196D              |                               |
| LT-A 500 FK3/FK4/FK5/FK6/FK7 Vinson        |       |                  |                                    |                       |                         |  |                     |                                    |                      |                               |
| 4WD Auto                                   | 03-07 | FA54TT*          | FA54R*                             | MD6195D               | MD6195D                 |  |                     | FA372R                             | MD6196D              |                               |
| LT-F 500 FW/FX/FY/FK1/FK2                  | 98-02 | FA135TT          | FA135R                             | MD6145D               |                         |  | S634                | S634G                              |                      |                               |
|  | Right | FA165TT          | FA165R                             |                       | MD6145D                 |  |                     |                                    |                      |                               |
| LT-F 500 FK3/FK4/FK5/FK6/FK7               |       |                  |                                    |                       |                         |  |                     |                                    |                      |                               |
| Vinson Quadrunner                          | 03-07 | FA54TT*          | FA54R*                             | MD6195D               | MD6195D                 |  | FA372TT             | FA372R                             | MD6196D              |                               |
| GT 550 K/L/M                               | 73-75 | FA55             |                                    |                       | MD3019RS                |  | S609                |                                    |                      |                               |
| GT 550 A/B                                 | 76-77 | FA55             |                                    |                       | MD3019RS                |  | S611                |                                    |                      |                               |
| GS 550 DB/DC                               | 77-78 | FA38*            |                                    | MD3014LS              | MD3014RS                |  | S611                |                                    |                      |                               |
| GS 550 EC/EN                               | 78-79 | FA38*            |                                    | MD3014LS              | MD3014RS                |  | FA36                |                                    | MD3014               |                               |
| GS 550 ET/EX/EZ/LT/LX/MX/MZ                | 80-84 | FA65*            |                                    | MD3014LS              | MD3014RS                |  | FA36                |                                    | MD3014               |                               |
| GSX 550 ESD/ESE/EFE/EF/ESH/EF/G (GN71D)    | 84-87 | FA63*            | FA63HH*                            | MD3024LS              | MD3024RS                |  | FA63                | FA63HH                             | MD3025               |                               |
| DR 600 SF/RG/RH/SG/SH (SN41A)              | 85-87 | FA106/2TT        | FA106/2R                           | MD6075D               |                         |  | S602                | S602G                              |                      |                               |
| GSF 600 S/T/STV/SV/W/SW/X/SX "Bandit"      | 95-99 | FA142*           | FA142HH*                           | MD3003LS              | MD3003RS                | MD3003C*   | FA63                | FA63HH                             | MD3008               | MD3008C                       |
| GSF 600 Y/SY/K1/SK1/K2                     | 00-04 | FA229            | FA229HH                            | MD3003LS              |                         | MD3003C  | FA63                | FA63HH                             | MD3008               | MD3008C                       |
| /SK2/K3/SK3/K4/SK4 Bandit                  | Right | FA231            | FA231HH                            |                       | MD3003RS                | MD3003C  |                     |                                    |                      |                               |
| GSR 600 K6/AK7                             | 06-07 | FA158*           | FA158HH*                           | MD3092LS              | MD3092LS                | MD3092C*   | FA419               | FA419HH                            | MD3093               | MD3093C                       |
| GSX 600 FJ (GN72A)                         | 88    | FA146*           | FA146HH*                           | MD3001LS              | MD3001RS                |  | FA63                | FA63HH                             | MD3002               | MD3002C                       |
| GSX 600 FK/FL/FM/FN/FP/FR/FS/FT/FV (GN72A) | 89-97 | FA146*           | FA146HH*                           | MD3003LS              | MD3003RS                | MD3003C*   | FA63                | FA63HH                             | MD3002               | MD3002C                       |
| GSX 600 FW/FX/FY/FK1                       | 98-02 | FA229            | FA229HH                            | MD3003LS              |                         | MD3003C  | FA63                | FA63HH                             | MD3008               | MD3008C                       |
| /FK2                                       | Right | FA231            | FA231HH                            |                       | MD3003RS                | MD3003C  |                     |                                    |                      |                               |
| GSX 600 FK3/FK4/FK5/FK6                    | 03-04 | FA229            | FA229HH                            | MD3090LS              |                         | MD3090C  | FA63                | FA63HH                             | MD3008               | MD3008C                       |
|  | Right | FA231            | FA231HH                            |                       | MD3090RS                | MD3090C  |                     |                                    |                      |                               |
| GSXR 600 V/W/X/Y/K1/K2/K3/ZK3              | 97-03 | FA158*           | FA158HH*                           | MD3058LS              | MD3058RS                | MD3058C*   | FA63                | FA63HH                             | MD3060               | MD3060C                       |
| GSXR 600 K4/K5                             | 04-05 | →                | FA379HH*                           | MD3089LS              | MD3089RS                | MD3089C*   | FA254               | FA254HH                            | MD3060               | MD3060C                       |
| GSXR 600 K6/K7                             | 06-07 | →                | FA379HH*                           | MD3091LS              | MD3091RS                | MD3091C*   | FA419               | FA419HH                            | MD3060               | MD3060C                       |
| RF 600 RP/RR/RS/RT/RV (GN76A)              | 93-97 | FA142*           | FA142HH*                           | MD3003LS              | MD3003RS                | MD3003C*   | FA63                | FA63HH                             | MD3008               | MD3008C                       |
| VS 600 GLS/GLT                             | 95-96 | FA103            | FA103HH                            |                       | MD3032RS                |  | S626                |                                    |                      |                               |
| UV 620 FK5 Side x Side                     | 05    | K719*            |                                    |                       |                         |  | K720*               |                                    |                      |                               |
| AN 650 K3 Burgman                          | 03    | FA142*           | FA142HH*                           | MD987D                | MD987D                  |  | FA412               | FA412HH                            | MD988D               |                               |
| AN 650 AK4/K4/AK5/K5/AK6/AK7 Burgman       | 04-07 | FA142*           | FA142HH*                           | MD994D                | MD994D                  |  | FA412               | FA412HH                            | MD998D               |                               |
| DL 650 K4/K5/K6 V-Strom                    | 04-06 | FA229            | FA229HH                            | MD3088LS              |                         | MD3088C  | FA174               | FA174HH                            | MD6232D              |                               |
|  | Right | FA231            | FA231HH                            |                       | MD3088RS                | MD3088C  |                     |                                    |                      |                               |
| DL 650 AK7 V-Strom ABS                     | 07    | FA229            | FA229HH                            | MD3092LS              |                         | MD3092C  | FA174               | FA174HH                            | MD6232D              |                               |
|  | Right | FA231            | FA231HH                            |                       | MD3092RS                | MD3092C  |                     |                                    |                      |                               |
| DL 650 K7                                  | 07    | FA229            | FA229HH                            | MD3092LS              |                         | MD3092C  | FA174               | FA174HH                            | MD6232D              |                               |
|  | Right | FA231            | FA231HH                            |                       | MD3092RS                | MD3092C  |                     |                                    |                      |                               |
| DR 650 RL/RM (SP41A)                       | 90-91 | FA147            | FA147R                             | MD6076D               |                         |  | FA157               | FA157R                             | MD6077D              |                               |
| DR 650 RSL/RSM (SP42A)                     | 90-91 | FA147            | FA147R                             | MD6076D               |                         |  | FA157               | FA157R                             | MD6077D              |                               |

\*-2 Sets Required. ■ - Also available in MX-S race compound, see page 8. ✖ - Oversize and Supermoto disc available - see page 301.

**SAFETY WARNING:- DO NOT USE HH PADS ON REAR UNLESS ALSO USED ON FRONT TO AVOID BRAKE IMBALANCE.**

R Suffix = High Durability Sintered Pad. HH Suffix = High Performance Sintered Pad. G Suffix = Grooved Shoe.  
D Suffix = Drilled Disc. C Suffix = Contoured Disc. LS Suffix = Left/Steel Disc. RS = Right/Steel Disc.

BRAKE APPLICATIONS

# JAPANESE Built Motorcycles

APPLICATIONS

BRAKE



|  |            | Front/Avant/Vorn |                                    |                   | Frente/Anteriore    |  | Rear/Arrière/Hinten |  | Posterior/Posteriore |                               |
|--|------------|------------------|------------------------------------|-------------------|---------------------|--|---------------------|--|----------------------|-------------------------------|
|  |            | ①                | ②                                  | ③                 | ④                   | ⑤  | ⑥                   | ⑦                                      | ⑧                    | ⑨                             |
|  |            |                  | Sintered/HH Pads/<br>Grooved shoes | Left/Gauche/Links | Right/Droite/Rechts | Contour Rotor<br>Universal left<br>and right fitment |                     | Sintered/<br>HH Pads/<br>Grooved shoes |                      | Contour Rotor<br>Rear fitment |
| <b>SUZUKI</b> contd.   |            |                  |                                    |                   |                     |  |                     |  |                      |                               |
| DR 650 RSEM/RSEN/RSEP/RES (SP43A)                            | 91-95      |                  | FA147                              | FA147R            | MD6078D             |  |                     | FA157                                  | FA157R               | MD6077D                       |
| DR 650 RUN/RN/RUP/RP (SP44A1B)                               | 92-93      |                  | A147                               | FA147R            | MD6078D             |  |                     | FA157                                  | FA157R               | MD6077D                       |
| DR 650 SET   | 96         |                  | FA185TT                            | FA185R            | MD6094D             |  |                     | FA152TT                                | FA152R               | MD6095D                       |
| GR 650 D/XD "Tempter"  | 83         |                  | FA65                               |                   | MD3014LS            |  |                     | S606                                   |                      |                               |
| GS 650 GTX/GTZ/GTD/GX/GZ                                     | 81-83      |                  | FA65*                              |                   | MD3014LS            | MD3014RS   |                     | FA36                                   |                      | MD3027                        |
| GSF 650 K5/SK5 Bandit  | Left 05    |                  | FA229                              | FA229HH           | MD3090LS            |  | MD3090C             | FA254                                  | FA254HH              | MD3008                        |
|  | Right      |                  | FA231                              | FA231HH           |                     | MD3090RS   | MD3090C             |  |                      |                               |
| GSF 650 K6/SAK6 (Bandit)                                     | Left 06    |                  | FA229                              | FA229HH           | MD3090LS            |  | MD3090C             | FA174                                  | FA174HH              | MD3008                        |
|  | Right      |                  | FA231                              | FA231HH           |                     | MD3090RS   | MD3090C             |  |                      |                               |
| GSF 650 K7/SAK7  | 07         |                  | FA158*                             | FA158HH*          | MD3092LS            | MD3092RS   | MD3092C*            | FA174                                  | FA174HH              | MD3093                        |
| XN 85 "Turbo"  | 83         |                  | FA65*                              |                   | MD3028LS            | MD3028RS   |                     | FA36                                   |                      | MD3014                        |
| LS 650 FG/PK/PM/PR/PG/PT/PV                                  |            |                  |                                    |                   |                     |  |                     |  |                      |                               |
| /PW/PX "Savage" NP41A  | 87-99      |                  | FA106TT                            |                   | MD3017LS            |  |                     | S606                                   |                      |                               |
| SV 650 X/Y/K1/K2   | Left 99-02 |                  | FA229                              | FA229HH           | MD3003LS            |  | MD3003C             | FA63                                   | FA63HH               | MD3008                        |
|  | Right      |                  | FA231                              | FA231HH           |                     | MD3003RS   | MD3003C             |  |                      |                               |
| SV 650 SX/SY/SK1/SK2   | Left 99-02 |                  | FA229                              | FA229HH           | MD3003LS            |  | MD3003C             | FA63                                   | FA63HH               | MD3008                        |
|  | Right      |                  | FA231                              | FA231HH           |                     | MD3003RS   | MD3003C             |  |                      |                               |
| SV 650 SK3/K3/SK4/K4/SK5                                     | Left 03-07 |                  | FA229                              | FA229HH           | MD3090LS            |  | MD3090C             | FA174                                  | FA174HH              | MD3060                        |
| /K5/SK6/K6/K7/SK7  | Right      |                  | FA231                              | FA231HH           |                     | MD3090RS   | MD3090C             |  |                      |                               |
| SV 650 AK7/SAK7 ABS Model                                    | Left 07    |                  | FA229                              | FA229HH           | MD3094LS            |  | MD3094C             | FA174                                  | FA174HH              | MD3093                        |
|  | Right      |                  | FA231                              | FA231HH           |                     | MD3094RS   | MD3094C             |  |                      |                               |
| XF 650 V/W/X/Y "Freewind"                                    | 97-02      |                  | FA231                              | FA231HH           |                     | MD6113DR   |                     | FA140                                  | FA140HH              | MD6095                        |
| GS 700 EF/ESF  | 85         |                  | FA51*                              |                   | MD3028LS            | MD3028RS   |                     | FA36                                   |                      | MD3029                        |
| LT-A 700 XK5/XCK6/XK6/XK7                                    | Left 05-07 |                  | FA413TT                            | FA413R            | MD6261D             |  |                     | N/A                                    |                      |                               |
| King Quad  | Right      |                  | FA414TT                            | FA414R            |                     | MD6261D  |                     |  |                      |                               |
| LT-V 700 FK4/FK5   | Left 04-05 |                  |                                    | FA342R            | MD6188D             |  |                     | N/A                                    |                      |                               |
| Twin Peaks   | Right      |                  |                                    | FA349R            |                     | MD6188D  |                     |  |                      |                               |
| VS 700 GLEFG/GLEPG/GLEFH/                                    |            |                  |                                    |                   |                     |  |                     |  |                      |                               |
| GLEPH (Cast wheel 5 bolt)                                    | 86-87      |                  | FA103                              | FA103HH           | MD3073LS            |  |                     | S626                                   |                      |                               |
| VS 700 GLFG/GLPG (Spoke wheel 5 bolt)                        | 86         |                  | FA103                              | FA103HH           | MD3031LS            |  |                     | S626                                   |                      |                               |
| VS 700 GLFH/GLPH (Spoke wheel 6 bolt)                        | 87         |                  | FA103                              | FA103HH           | MD3032LS            |  |                     | S626                                   |                      |                               |
| DR 750 SJ (SR41A)  | 88         |                  | FA147                              | FA147R            | MD6076D             |  |                     | S606                                   |                      |                               |
| DR 750 SK (SR41A)  | 89         |                  | FA147                              | FA147R            | MD6076D             |  |                     | FA157                                  | FA157R               | MD6077D                       |
| GT 750 K/L/M/A/B   | 73-77      |                  | FA55*                              |                   | MD3019LS            | MD3019RS   |                     | S634                                   |                      |                               |
| GS 750 B   | 77         |                  | FA35                               |                   |                     | MD3019RS   |                     | FA36                                   |                      | MD3014                        |
| GS 750 DB/DC/EC/EN   | 77-80      |                  | FA35*                              |                   | MD3014LS            | MD3014RS   |                     | FA36                                   |                      | MD3014                        |
| GSX 750 ET/EX  | 80-81      |                  | FA51*                              |                   | MD3014LS            | MD3014RS   |                     | FA36                                   |                      | MD3014                        |
| GSX 750 ESD/EF/ESG/ESE/ESH/EFF                               | 82-86      |                  | FA51*                              |                   | MD3028LS            | MD3028RS   |                     | FA36                                   |                      | MD3029                        |
| GSX 750 S/SS (GS75X-106815-)                                 | 84         |                  | FA65*                              |                   | MD3028LS            | MD3028RS   |                     | FA36                                   |                      | MD3014                        |
| GSX 750 S-2/S-2C Katana (FS75X-114747-)                      | 84         |                  | FA65*                              |                   | MD3028LS            | MD3028RS   |                     | FA36                                   |                      | MD3014                        |
| GSX 750 SE "Katana" (GR72A)                                  | 85         |                  | FA63*                              | FA63HH*           | MD3014LS            | MD3014RS   |                     | FA36                                   |                      | MD3029                        |
| GSXR 750 F/G/H (GR75A)                                       | 85-87      |                  | FA103*                             | FA103HH*          | MD3005LS            | MD3005RS   |                     | FA63                                   | FA63HH               | MD3009                        |
| GSXR 750 RG  | 86         |                  | FA145*                             | FA145HH*          | MD3005LS            | MD3005RS   |                     | FA63                                   | FA63HH               | MD3009                        |
| GSXR 750 J/K/L/M/WN/WP                                       | 88-93      |                  | FA145*                             | FA145HH*          | MD3007LS            | MD3007RS   | MD3007C*            | FA63                                   | FA63HH               | MD3008                        |
| GSXR 750 WR/WS   | 94-95      |                  | FA188*                             | FA188HH*          | MD3007LS            | MD3007RS   | MD3007C*            | FA63                                   | FA63HH               | MD3008                        |
| GSXR 750 T/V/W/X   | 96-99      |                  | FA188*                             | FA188HH*          | MD3058LS            | MD3058RS   | MD3058C*            | FA63                                   | FA63HH               | MD3060                        |
| GSXR 750 Y/K1/K2/K3  | 00-03      |                  | FA158*                             | FA158HH*          | MD3058LS            | MD3058RS   | MD3058C*            | FA63                                   | FA63HH               | MD3060                        |
| GSXR 750 K4/K5   | 04-05      |                  |                                    | FA379HH*          | MD3089LS            | MD3089RS   | MD3089C*            | FA254                                  | FA254HH              | MD3060                        |
| GSXR 750 K6/K7   | 06-07      |                  |                                    | FA379HH*          | MD3091LS            | MD3091RS   | MD3091C*            | FA419                                  | FA419HH              | MD3060                        |
| GSX 750 W/X/Y/K1   | Left 98-03 |                  | FA229                              | FA229HH           | MD3045LS            |  |                     | FA63                                   | FA63HH               | MD3008                        |
|  | Right      |                  | FA231                              | FA231HH           |                     | MD3045RS   |                     |  |                      |                               |
| GSX 750 FK/FL/FM/FN/FP/FR/FS/FT/FV (GR78A)                   | 89-97      |                  | FA146*                             | FA146HH*          | MD3003LS            | MD3003RS   | MD3003C*            | FA63                                   | FA63HH               | MD3002                        |
| GSX 750 FW/FX/FY/FK1/FK2                                     | Left 98-02 |                  | FA229                              | FA229HH           | MD3003LS            |  | MD3003C             | FA63                                   | FA63HH               | MD3008                        |
|  | Right      |                  | FA231                              | FA231HH           |                     | MD3003RS   |                     |  |                      |                               |
| GSX 750 FK3/FK4/FK5/FK6                                      | Left 03-06 |                  | FA229                              | FA229HH           | MD3090LS            |  | MD3090C             | FA63                                   | FA63HH               | MD3008                        |
|  | Right      |                  | FA231                              | FA231HH           |                     | MD3090RS   | MD3090C             |  |                      |                               |
| VS 750 GLF/GLFG/GLPG "Intruder" (Spoke wheel 5 bolt) (VR51A) | 85-90      |                  | FA103                              | FA103HH           | MD3031LS            |  |                     | S626                                   |                      |                               |
| VS 750 GLFH/GLPH "Intruder" (Spoke Wheel 6 bolt) (VR51A)     | 87         |                  | FA103                              | FA103HH           | MD3032LS            |  |                     | S626                                   |                      |                               |

\*-2 Sets Required. ■ - Also available in MX-S race compound, see page 8. ✖ - Oversize and Supermoto disc available - see page 301.

**SAFETY WARNING:- DO NOT USE HH PADS ON REAR UNLESS ALSO USED ON FRONT TO AVOID BRAKE IMBALANCE.**

# JAPANESE Built Motorcycles



SUZUKI contd.

|   |       | Front/Avant/Vorn |                                |                   | Frente/Anteriore    |  | Rear/Arrière/Hinten |                                | Posterior/Posteriore |                            |
|---|-------|------------------|--------------------------------|-------------------|---------------------|--|---------------------|--------------------------------|----------------------|----------------------------|
|   |       | 1                | 2                              | 3                 | 4                   | 5  | 6                   | 7                              | 8                    | 9                          |
|   |       |                  | Sintered/HH Pads/Grooved shoes | Left/Gauche/Links | Right/Droite/Rechts | Contour Rotor Universal left and right fitment |                     | Sintered/HH Pads/Grooved shoes |                      | Contour Rotor Rear fitment |
| VS 750 GLEFH/GLEPH "Intruder" (Cast Wheel 5 bolt) (VR51A)     | 87    | FA103            | FA103HH                        | MD3073LS          |                     |  | S626                |                                |                      |                            |
| VS 750 GLPK/GLPL/GLPM "Intruder" (Spoke Wheel 6 bolt) (VR51A) | 88-91 | FA103            | FA103HH                        |                   | MD3032RS            |  | S626                |                                |                      |                            |
| DR 800 SL (SR43A)   | 90    | FA147            | FA147R                         | MD6076D           |                     |  | FA157               | FA157R                         | MD6077D              |                            |
| DR 800 SM (SR43A)   | 91    | FA129            | FA129R                         | MD6113D           |                     |  | FA165/2TT           | FA165/2R                       | MD6077D              |                            |
| VL 800 K1/K2/K3/K4 "Intruder Volusia"                         | 01-04 | FA231            | FA231HH                        |                   | MD3095RS            |  | S626                |                                |                      |                            |
| VL 800 K5/K6/K7 (800 Intruder)                                | 05-07 | FA231            | FA231HH                        |                   | MD3095RS            |  | S626                |                                |                      |                            |
| VS 800 GLN/GLP/GLR/GLS/GLT/GLV/GLW/GLX "Intruder" (VS52A)     | 92-99 | FA103            | FA103HH                        |                   | MD3032RS            |  | S626                |                                |                      |                            |
| VX 800 L/M/N/P/R  | 90-96 | FA129            | FA129HH                        | MD3033LS          |                     |  | FA146               | FA146HH                        | MD3061               |                            |
| VZ 800 V/W/X/Y/K1/K2 "Marauder"                               | 97-03 | FA231            | FA231HH                        |                   | MD3045RS            |  | S626                |                                |                      |                            |
| VZ 800 K5-K7 Intruder M800                                    | 05-07 | FA231            | FA231HH                        |                   | MD3096RS            |  | S626                |                                |                      |                            |
| GS 850 GN/GT/GX   | 79-81 | FA38*            |                                | MD3014LS          | MD3014RS            |  | FA36                |                                | MD3014               |                            |
| GS 850 GZ/GE/GG   | 82-85 | FA51*            |                                | MD3014LS          | MD3014RS            |  | FA36                |                                | MD3027               |                            |
| RF 900 RR/RS/RS2  | 94-95 | FA145*           | FA145HH*                       | MD3006LS          | MD3006RS            | MD3006C*                                       | FA222               |                                | MD3008               | MD3008C                    |
| RF 900 RT/RV/RW   | 96-99 | FA145*           | FA145HH*                       | MD3006LS          | MD3006RS            | MD3006C*                                       | FA63                | FA63HH                         | MD3008               | MD3008C                    |
| DL 1000 K2/K3/K4/K5/K6/K7 Left V-Strom Right                  | 02-07 | FA229            | FA229HH                        | MD3088LS          |                     | MD3088C  | FA174               | FA174HH                        | MD6232D              |                            |
| GS 1000 HC/EC/EN/SN   | 78-80 | FA38*            |                                | MD3014LS          | MD3014RS            |  | FA36                |                                | MD3014               |                            |
| GS 1000 ET  | 81    | FA65*            |                                | MD3014LS          | MD3014RS            |  | FA36                |                                | MD3014               |                            |
| GS 1000 GT/GX   | 81-82 | FA51*            |                                | MD3014LS          | MD3014RS            |  | FA36                |                                | MD3014               |                            |
| GSX 1000 SZ "Katana"  | 82    | FA65*            |                                | MD3014LS          | MD3014RS            |  | FA36                |                                | MD3014               |                            |
| GSXR 1000 K1/K2   | 01-02 | FA188*           | FA188HH*                       | MD3058LS          | MD3058RS            | MD3058C*                                       | FA254               | FA254HH                        | MD3060               | MD3060C                    |
| GSXR 1000 K3  | 03    | →                | FA369/4HH*                     | MD3089LS          | MD3089RS            | MD3089C*                                       | FA254               | FA254HH                        | MD3060               | MD3060C                    |
| GSXR 1000 K4  | 04    | →                | FA379HH*                       | MD3089LS          | MD3089RS            | MD3089C*                                       | FA254               | FA254HH                        | MD3060               | MD3060C                    |
| GSXR 1000 K5/K6   | 05-06 |                  | FA379HH*                       | MD3091LS          | MD3091RS            | MD3091C*                                       | FA254               | FA254HH                        | MD3060               | MD3060C                    |
| GSXR 1000 K7  | 07    |                  | FA379HH*                       | MD3091LS          | MD3091RS            | MD3091C*                                       | FA419               | FA419HH                        | MD3060               | MD3060C                    |
| SV 1000 K3/K3/K4/SK4/K5/SK5/SK6                               | 03-06 | FA158*           | FA158HH*                       | MD3088LS          | MD3088RS            | MD3088C*                                       | FA174               | FA174HH                        | MD3060               | MD3060C                    |
| TL 1000 SV/SW/SX/SY/SK1                                       | 97-01 | FA158*           | FA158HH*                       | MD3058LS          | MD3058RS            | MD3058C*                                       | FA63                | FA63HH                         | MD3060               | MD3060C                    |
| TL 1000 RW/RX/RV/RK1  | 98-02 | FA188*           | FA188HH*                       | MD3058LS          | MD3058RS            | MD3058C*                                       | FA63                | FA63HH                         | MD3060               | MD3060C                    |
| GSX 1100 ET/EX/EZ   | 80-82 | FA65*            |                                | MD3014LS          | MD3014RS            |  | FA36                |                                | MD3014               |                            |
| GSX 1100 ESD  | 83    | FA65*            |                                | MD3014LS          | MD3014RS            |  | FA36                |                                | MD3014               |                            |
| GSX 1100 SZ/SD "Katana"                                       | 82-83 | FA65*            |                                | MD3014LS          | MD3014RS            |  | FA36                |                                | MD3014               |                            |
| GS 1100 GZ  | 82    | FA65*            |                                | MD3014LS          | MD3014RS            |  | FA36                |                                | MD3027               |                            |
| GSX 1100 EFE/EFF/ESE  | 84-86 | FA103*           | FA103HH*                       | MD3039LS          | MD3039RS            |  | FA103               | FA103HH                        | MD3039               |                            |
| GSX 1100 FJ/FK/FL/FM/FN/FP (GV72A)                            | 88-93 | FA146*           | FA146HH*                       | MD3039LS          | MD3039RS            |  | FA103               | FA103HH                        | MD3036               |                            |
| GSXR 1100 G/H/J (GV74B)                                       | 86-88 | FA103*           | FA103HH*                       | MD3004LS          | MD3004RS            |  | FA63                | FA63HH                         | MD3009               |                            |
| GSXR 1100 K/L/M/N (GV73B)                                     | 89-92 | FA145*           | FA145HH*                       | MD3007LS          | MD3007RS            | MD3007C*                                       | FA63                | FA63HH                         | MD3008               | MD3008C                    |
| GSXR 1100 WP/WR/WS/WT (GV75A)                                 | 93-96 | FA188*           | FA188HH*                       | MD3007LS          | MD3007RS            | MD3007C*                                       | FA63                | FA63HH                         | MD3008               | MD3008C                    |
| GSX 1100 GM/GN/GR   | 91-96 | FA129*           | FA129HH*                       | MD3037LS          | MD3037RS            |  | FA146               | FA146HH                        | MD3038               |                            |
| GS 1200 SSK1/ZK1 (GV78A)                                      | 01    | FA188*           | FA188HH*                       | MD3006LS          | MD3006RS            | MD3006C*                                       | FA254               | FA254HH                        | MD3008               | MD3008C                    |
| GSF 1200 T/ST/V/SV/SW/W/X/SX /SY/Y "Bandit"                   | 96-00 | FA145*           | FA145HH*                       | MD3006LS          | MD3006RS            | MD3006C*                                       | FA63                | FA63HH                         | MD3008               | MD3008C                    |
| GSF 1200 SAV ABS-Bandit                                       | 97    | FA145*           | FA145HH*                       | MD3075LS          | MD3075RS            |  | FA63                | FA63HH                         | MD3076               |                            |
| GSF 1200 K1/SK1/K2/SK2/SK3 /K3/K4/SK4/K5/SK5 "Bandit"         | 01-05 | FA188*           | FA188HH*                       | MD3006LS          | MD3006RS            | MD3006C*                                       | FA63                | FA63HH                         | MD3008               | MD3008C                    |
| GSF 1200 SAK6/AK6/GTSAK6                                      | 06    | FA158*           | FA158HH*                       | MD3092LS          | MD3092RS            | MD3092C*                                       | FA174               | FA174HH                        | MD3093               | MD3093C                    |
| GSX 1200 FSW/FSX "Inazuma"                                    | 98-99 | FA244*           | FA244HH*                       | MD3006LS          | MD3006RS            | MD3006C*                                       | FA63                | FA63HH                         | MD3008               | MD3008C                    |
| GV 1200 GLF/GLF2/GLG "Madura"                                 | 85-86 | FA51*            |                                | MD3030LS          | MD3030RS            |  | FA36                |                                | MD3041               |                            |
| GSF 1250 AK7/ASK7 Bandit                                      | 07    | FA158*           | FA158HH*                       | MD3092LS          | MD3092RS            | MD3092C*                                       | FA174               | FA174HH                        | MD3093               | MD3093C                    |
| GSX 1300 RX/RV/RK1/RK2/RK3 /RK3/RK4/RK5/K6/K7 Hayabusa        | 99-07 | FA188*           | FA188HH*                       | MD3058LS          | MD3058RS            | MD3058C*                                       | FA63                | FA63HH                         | MD3008               | MD3008C                    |
| GSX 1400 K1/K2/K3/K4/K5/K6/K7                                 | 01-07 | FA188*           | FA188HH*                       | MD3058LS          | MD3058RS            | MD3058C*                                       | FA254               | FA254HH                        | MD3083               | MD3083C                    |
| GV 1400 GDG/GTG Cavalcade (Up to F/No 103764)                 | 86    | FA103*           | FA103HH*                       | MD3042LS          | MD3042RS            |  | FA103               | FA103HH                        | MD3043               |                            |
| GV 1400 GDG/GCG/GDH/GDJ/GCH "Cavalcade" (From f/No 103765)    | 86-88 | FA146*           | FA146HH*                       | MD3042LS          | MD3042RS            |  | FA150               | FA150HH                        | MD3043               |                            |

\*-2 Sets Required. ■ - Also available in MX-S race compound, see page 8. ✖ - Oversize and Supermoto disc available - see page 301.

**SAFETY WARNING:- DO NOT USE HH PADS ON REAR UNLESS ALSO USED ON FRONT TO AVOID BRAKE IMBALANCE.**

R Suffix = High Durability Sintered Pad. HH Suffix = High Performance Sintered Pad. G Suffix = Grooved Shoe.  
D Suffix = Drilled Disc. C Suffix = Contoured Disc. LS Suffix = Left/Steel Disc. RS = Right/Steel Disc.

BRAKE APPLICATIONS

# JAPANESE Built Motorcycles

APPLICATIONS

BRAKE



| Front/Avant/Vorn                   |                   |                     | Frente/Anterore                                      |  |                               | Rear/Arrière/Hinten |   |   | Posterior/Posteriore |  |  |
|------------------------------------|-------------------|---------------------|--|--|-------------------------------|---------------------|---|---|----------------------|--|--|
| 1                                  | 2                 | 3                   | 4  | 5                                      | 6                             | 7                   | 8 | 9 |                      |  |  |
| Sintered/HH Pads/<br>Grooved shoes | Left/Gauche/Links | Right/Droite/Rechts | Contour Rotor<br>Universal left<br>and right fitment | Sintered/<br>HH Pads/<br>Grooved shoes | Contour Rotor<br>Rear fitment |                     |   |   |                      |  |  |

## SUZUKI contd.

|   |        |            |          |          |          |         |         |        |
|---|--------|------------|----------|----------|----------|---------|---------|--------|
| VS 1400 GLPH/GLFH/GLPJ/GLFJ/GLPR<br>/GLPT/GLPV/GLPW/GLPX/GLPY/GLPK1 |        |            |          |          |          |         |         |        |
| /GLPK2 Intruder (VX51L) 87-03                                       | FA103  | FA103HH    |          | MD3032RS |          | FA103   | FA103HH | MD3044 |
| VL 1500 WX "Intruder Legendary Classic" 98-99                       | FA103  | FA103HH    |          | MD3078RS |          | FA103   | FA103HH | MD3079 |
| VL 1500 Y/K1 Intruder Legendary<br>Classic 00-01                    | FA103  | FA103HH    |          | MD3078RS |          | FA103   | FA103HH | MD3086 |
| VL 1500 K2/K3 Intruder Left 02-03                                   | FA229  | FA229HH    | MD3087LS |          |          | FA366TT |         | MD3086 |
| Legendary Classic Right   | FA231  | FA231HH    |          | MD3087RS |          |         |         |        |
| VL 1500 K5/K6/K7 Left 05-07   | FA229  | FA229HH    | MD3087LS |          |          | FA366TT |         | MD3086 |
| (C 1500 Intruder) Right   | FA231  | FA231HH    |          | MD3087RS |          |         |         |        |
| VZ 1600 K4 Marauder 04  | FA188* | FA188HH*   | MD4022LS | MD4022RS | MD4022C* | FA231   | FA231HH | MD4146 |
| VZ 1600 K5 (M 1600 Intruder) 05                                     |        | FA369/4HH* | MD4022LS | MD4022RS | MD4022C* | FA231   | FA231HH | MD4146 |
| VZR 1800 K6/K7 (M 1800 R Intruder/M109R) 06-07                      |        | FA379HH*   | MD3091LS | MD3091RS | MD3091C* | FA231   | FA231HH | MD3086 |

## YAMAHA

|  |         |         |         |     |         |       |       |         |
|--|---------|---------|---------|-----|---------|-------|-------|---------|
| BA 50 C (4KNH) Gear-C 04   | Y531    |         |         |     |         | Y530  |       |         |
| BW'S (3TX/4CA) CW 50 T "Bi-Wizz" 90-94                                 | Y518    |         |         |     |         | Y518  |       |         |
| BW'S 50 "Next Generation" (Twin headlight<br>model) (190mm disc) 99-07 | FA193   | FA193HH | MD923D  |     |         | Y503  |       |         |
| BW-S 50 Original (180mm disc) 99-02                                    | FA193   | FA193HH | MD916D  |     |         | Y503  |       |         |
| CA 50 "Salient" 83-85  | Y501    |         |         |     |         | Y519  |       |         |
| CG 50 "Jog" 88-92  | Y501    |         |         |     |         | Y519  |       |         |
| CR-Z 50 (3WN) 91-95  | FA169   | FA169HH | MD904D  |     |         | Y503  |       |         |
| CS 50 P/R Jog R 02-07  | FA193   | FA193HH | MD943D  |     |         | Y503  |       |         |
| CS 50 R Jog RR 03-07   | FA193   | FA193HH | MD943D  |     |         | Y503  |       |         |
| CT 50 S (3NT6) 90-95   | Y503    |         |         |     |         | Y503  |       |         |
| CT 50 SS (3NTC) 92-95  | Y503    |         |         |     |         | Y503  |       |         |
| CV 50 Jog (5KN1/2) (Coolstyle) 00-02                                   | FA336   |         | MD965D  |     |         | Y530  |       |         |
| CV 50 ZR Evolution (5PT1) 01-02  | FA336   |         | MD965D  |     |         | Y530  |       |         |
| CV 50 A/R Jog (5SU2/1) 03  | FA384   |         | MD965D  |     |         | Y530  |       |         |
| CW 50 RS (4YA1/2/BWS)<br>(180mm front disc) 96-97                      | FA193   | FA193HH | MD916D  |     |         | Y503  |       |         |
| CW 50 RSP (5CC1/3/4YA BW'S Spy)<br>(180mm front disc) 97-98            | FA193   | FA193HH | MD916D  |     |         | Y503  |       |         |
| CW 50 RS (4YA4/BWs NG)<br>(180mm front disc) 98                        | FA193   | FA193HH | MD916D  |     |         | Y503  |       |         |
| CW 50 RS (5FXA/VG5SA BW'S)<br>(190mm front disc) 99                    | FA193   | FA193HH | MD923D  |     |         | Y503  |       |         |
| CW 50 RS (5FXJ/VG5SA BW'S)<br>(190mm front disc) 00                    | FA193   | FA193HH | MD923D  |     |         | Y503  |       |         |
| CW 50 RS (5FXM/VG5SA BW'S)<br>(190mm front disc) 01-05                 | FA193   | FA193HH | MD923D  |     |         | Y503  |       |         |
| CW 50 (5MS2/4G54R) 02  | FA193   | FA193HH | MD923D  |     |         | Y503  |       |         |
| CW 50 (5WW4/BW'S) 05   | FA193   | FA193HH | MD916D  |     |         | Y530  |       |         |
| CY 50 "Jog-in" 91-95   | Y519    |         |         |     |         | Y518  |       |         |
| DT 50 LC 98-   | FA119TT | FA119R  | MD6158D |     | MD6158C | Y503  |       |         |
| DT 50 M/MX 78-86   | Y504    | Y504G   |         |     |         | Y504  | Y504G |         |
| DT 50 MX 87-91   | Y518    | Y518G   |         |     |         | Y518  | Y518G |         |
| DT 50 MX 92-95   | Y503    | Y503G   |         |     |         | Y503  | Y503G |         |
| DT 50 R 97-01  | FA116   |         | MD6214D |     |         | Y503  |       |         |
| DT 50 R 02-06  | FA350   |         | MD6297D |     |         | FA350 |       | MD6280D |
| DT 50 X (Supermotard) 04-07  | FA194   | FA194HH | MD6279D |     |         | FA350 |       | MD6280D |
| DT 50 R-L (SM-5VB1/VG55BK) 02-03                                       | FA116   |         | MD6214D |     |         | FA382 |       | MD6286D |
| EW 50 "Slider" 00-05   | FA268   |         | MD923D  |     |         | Y503  |       |         |
| FS1E 74-76   | Y504    |         |         |     |         | Y504  |       |         |
| FS1E "DX" 77-79  | FA28    |         |         | N/A |         | Y504  |       |         |
| FS1 "DX" 79-80   | FA42    |         |         | N/A |         | Y504  |       |         |
| FS1 "SE" 81-82   | Y504    |         |         |     |         | Y504  |       |         |
| FS1 87-90  | Y518    |         |         |     |         | Y518  |       |         |
| CY 50 RS Jog "R" 96-   | FA169   | FA169HH | MD904D  |     |         | Y503  |       |         |

\*-2 Sets Required. ■ - Also available in MX-S race compound, see page 8. ✖ - Oversize and Supermoto disc available - see page 301.

**SAFETY WARNING:- DO NOT USE HH PADS ON REAR UNLESS ALSO USED ON FRONT TO AVOID BRAKE IMBALANCE.**



# JAPANESE Built Motorcycles



YAMAHA contd.

|   |       | Front/Avant/Vorn                   |                   |                     | Frente/Anteriore                                     |         | Rear/Arrière/Hinten                |         | Posterior/Posteriore          |         |
|---|-------|------------------------------------|-------------------|---------------------|--|---------|------------------------------------|---------|-------------------------------|---------|
|   |       | 1                                  | 2                 | 3                   | 4  | 5       | 6                                  | 7       | 8                             | 9       |
|   |       | Sintered/HH Pads/<br>Grooved shoes | Left/Gauche/Links | Right/Droite/Rechts | Contour Rotor<br>Universal left<br>and right fitment |         | Sintered/HH Pads/<br>Grooved shoes |         | Contour Rotor<br>Rear fitment |         |
| LC 50 M "Bop"   | 80    | Y519                               |                   |                     |  |         | Y519                               |         |                               |         |
| MA 50 M "QT 50"   | 80-86 | Y501                               |                   |                     |  |         | Y501                               |         |                               |         |
| MJ 50 M "Towny"   | 82    | Y501                               |                   |                     |  |         | Y501                               |         |                               |         |
| MS 50   | 85-86 | Y501                               |                   |                     |  |         | Y519                               |         |                               |         |
| PW 50 H/J/K/S/U/90-07                                       | 80-07 | Y501                               |                   |                     |  |         | Y501                               |         |                               |         |
| RD 50 M   | 78    | FA28                               |                   |                     |  |         | Y504                               |         |                               |         |
| RD 50 M   | 79-80 | FA42                               |                   |                     | N/A  |         | Y504                               |         |                               |         |
| RD 50/RD 50 MX  | 81-87 | FA70                               |                   |                     | N/A  |         | Y504                               |         |                               |         |
| RZ 50 (5FC1/2)  | 02    | FA275                              | FA275HH           | TBA                 |  |         | Y503                               |         |                               |         |
| SA 50 M/ME "Passola"  | 80-84 | Y501                               |                   |                     |  |         | Y519                               |         |                               |         |
| T 50 "Townmate"   | 86    | Y518                               |                   |                     |  |         | Y518                               |         |                               |         |
| TT-R 50 EV/EW   | 06-07 | Y502                               | Y502G             |                     |  |         | Y503                               | Y503G   |                               |         |
| TY 50/50 M  | 77-80 | Y504                               | Y504G             |                     |  |         | Y504                               | Y504G   |                               |         |
| TZR 50 "Thunderkid" (41V21) (5DU1/3)                        | 97-00 | FA197                              | FA197HH           |                     | MD2067RS   |         | FA101                              |         | MD2077                        |         |
| TZR 50 (5WX1)   | 03-07 | FA194                              | FA194HH           | MD672LS             |  |         | FA115                              | FA115HH | TBA                           |         |
| V 50 M/P  | 74-82 | Y504                               |                   |                     |  |         | Y504                               |         |                               |         |
| V 50 M  | 83    | Y518                               |                   |                     |  |         | Y518                               |         |                               |         |
| XF 50 Giggle  | 07    | Y530                               |                   |                     |  |         | Y530                               |         |                               |         |
| YA 50 R Axis (4PC)  | 95-96 | FA193                              | FA193HH           | MD904D              |  |         | Y503                               |         |                               |         |
| YA 50 ZA Jog Z (4SC1)                                       | 95    | FA169                              | FA169HH           | N/A                 |  |         | Y503                               |         |                               |         |
| YB-1 (50cc) (5JE1/3)  | 01-02 | Y531                               |                   |                     |  |         | Y531                               |         |                               |         |
| YFM 50 S/T/RV/RW Raptor                                     | 04-07 | Y503*                              | Y503G*            |                     |  |         | Y527                               | Y527G   |                               |         |
| YSR 50 T  | 87    | FA101                              |                   | N/A                 |  |         | Y503                               |         |                               |         |
| YJ 50 R (5AU1-3) Vino                                       | 98-   | Y519                               |                   |                     |  |         | Y503                               |         |                               |         |
| YZ 50 G/H/J/K   | 80-83 | Y502                               | Y502G             |                     |  |         | Y502                               | Y502G   |                               |         |
| YE 50 "Zest"  | 93-95 | FA193                              | FA193HH           | MD904D              |  |         | Y518                               |         |                               |         |
| YH 50 "Why"   | 99-07 | FA193                              | FA193HH           | MD928D              |  |         | Y503                               |         |                               |         |
| YM 50 Breeze (4KH)  | 94-95 | FA193                              | FA193HH           | MD904D              |  |         | Y503                               |         |                               |         |
| YN 50 R "Neo's"   | 98-07 | FA193                              | FA193HH           | MD943D              |  |         | Y503                               |         |                               |         |
| YV 50 (5BM2) Jog Space Innovation                           | 97-   | Y519                               |                   |                     |  |         | Y503                               |         |                               |         |
| YQ 50 "Aerox/Aerox-R"                                       | 97-07 | FA193                              | FA193HH           | MD923D              |  |         | FA268                              |         | MD923D                        |         |
| YT 60 "Tri Zinger"  | 83    | None                               |                   |                     |  |         | Y518                               | Y518G   |                               |         |
| YF 60 S   | 88    | None                               |                   |                     |  |         | Y518                               | Y518G   |                               |         |
| V 70 A  | 76    | Y504                               |                   |                     |  |         | Y504                               |         |                               |         |
| V 75 A  | 77    | Y504                               |                   |                     |  |         | Y504                               |         |                               |         |
| CV 80 "Beluga"  | 81-83 | Y503                               |                   |                     |  |         | Y503                               |         |                               |         |
| DT 80 LC (37A)  | 81-84 | FA81                               | FA81R             | N/A                 |  |         | Y506                               |         |                               |         |
| DT 80 LC-2 (53V)  | 85-92 | FA101TT                            | FA101R            | N/A                 |  |         | Y506                               |         |                               |         |
| DT 80 MX  | 81-83 | Y504                               | Y504G             |                     |  |         | Y504                               | Y504G   |                               |         |
| DT 80 MX "36N Type"/MXS                                     | 83-85 | Y518                               | Y518G             |                     |  |         | Y518                               | Y518G   |                               |         |
| LB2/80 "Bop 2"  | 80    | Y504                               |                   |                     |  |         | Y504                               |         |                               |         |
| PW 80 K/S/91  | 83-91 | Y502                               | Y502G             |                     |  |         | Y518                               | Y518G   |                               |         |
| PW 80   | 93-07 | Y502                               | Y502G             |                     |  |         | Y503                               | Y503G   |                               |         |
| RD 80 (Air cooled)  | 82    | FA70                               |                   |                     | N/A  |         | Y504                               |         |                               |         |
| RD 80 LC  | 82    | FA81                               |                   |                     | N/A  |         | Y504                               |         |                               |         |
| T 80 "Townmate"   | 83-97 | Y518                               |                   |                     |  |         | Y518                               |         |                               |         |
| TY 80   | 77    | Y502                               | Y502              |                     |  |         | Y504                               | Y504G   |                               |         |
| TY 80   | 83-   | Y502                               | Y502              |                     |  |         | Y503                               | Y503G   |                               |         |
| V 80  | 79-82 | Y504                               |                   |                     |  |         | Y504                               |         |                               |         |
| V 80 DL   | 83    | Y518                               |                   |                     |  |         | Y518                               |         |                               |         |
| YFM 80 S  | 87    | None                               |                   |                     |  |         | Y506                               | Y506G   |                               |         |
| YFM 80 D/E/F/G/H/J/K/L/M/N Badger                           | 92-01 | Y503*                              | Y503G*            |                     |  |         | Y527                               | Y527G   |                               |         |
| YFM 80 WP/WR/WS/RT/RV/RW Raptor                             | 02-07 | Y503*                              | Y503G*            |                     |  |         | Y527                               | Y527G   |                               |         |
| YFM 80 GT/GV/GW Grizzly                                     | 05-07 | Y503*                              | Y503G*            |                     |  |         | Y527                               | Y527G   |                               |         |
| YZ 80 D/E/F   | 77-79 | Y502                               | Y502G             |                     |  |         | Y504                               | Y504G   |                               |         |
| YZ 80 G/H/J/K/L/N   | 80-85 | Y502                               | Y502G             |                     |  |         | Y502                               | Y502G   |                               |         |
| YZ 80 S/T/U/W   | 86-89 | FA119TT                            | FA119R            | MD6029D             |  |         | Y502                               | Y502G   |                               |         |
| YZ 80 E/F/L/W/LWG/G/LWH/H/LWJ/J<br>/LWK/K/L/LWL/M/LWM/N/LWN | 93-01 | FA119TT                            | FA119R            | MD6030DX            |  | MD6030C | →                                  | FA84/3R | MD6031D                       | MD6031C |

\*-2 Sets Required. ■ - Also available in MX-S race compound, see page 8. ✖ - Oversize and Supermoto disc available - see page 301.

**SAFETY WARNING:- DO NOT USE HH PADS ON REAR UNLESS ALSO USED ON FRONT TO AVOID BRAKE IMBALANCE.**

R Suffix = High Durability Sintered Pad. HH Suffix = High Performance Sintered Pad. G Suffix = Grooved Shoe.  
D Suffix = Drilled Disc. C Suffix = Contoured Disc. LS Suffix = Left/Steel Disc. RS = Right/Steel Disc.

BRAKE  
APPLICATIONS

# JAPANESE Built Motorcycles

APPLICATIONS

BRAKE



| Front/Avant/Vorn |                                    |                       | Frente/Anteriore        |  |   | Rear/Arrière/Hinten                |   |                               | Posterior/Posteriore |  |  |
|------------------|------------------------------------|-----------------------|-------------------------|--|---|------------------------------------|---|-------------------------------|----------------------|--|--|
| 1                | 2                                  | 3                     | 4                       | 5  | 6 | 7                                  | 8 | 9                             |                      |  |  |
|                  | Sintered/HH Pads/<br>Grooved shoes | Left/Gauche/Links<br> | Right/Droite/Rechts<br> | Contour Rotor<br>Universal left<br>and right fitment |   | Sintered/HH Pads/<br>Grooved shoes |   | Contour Rotor<br>Rear fitment |                      |  |  |

YAMAHA contd.

|  |       |         |           |          |          |         |         |         |         |         |
|--|-------|---------|-----------|----------|----------|---------|---------|---------|---------|---------|
| YZ 85 PL/WP/RL/WRS/LSWS/TLWT/LV/LW/W/LWW | 02-07 | FA119TT | FA119R    | MD6030DX | OSY6030C | MD6030C | →       | FA84/3R | MD6031D | MD6031C |
| Oversize Disc available                  |       |         |           |          |          |         |         |         |         |         |
| TT-R 90 M/N/P/R/ES/S/T/ET/EV/EW          | 00-07 | Y502    | Y502G     |          |          |         |         | Y503    | Y503G   |         |
| T 90 N/D (4NM1-9) Mate                   | 00-   | Y531    |           |          |          |         |         | Y531    |         |         |
| V 90                                     | 78    | Y504    |           |          |          |         |         | Y504    |         |         |
| AG 100 J (3HAA)                          | 82    | Y503    | Y503G     |          |          |         |         | Y527    | Y527G   |         |
| AG 100 E "Farm Bike"                     | 93    | Y503    | Y503G     |          |          |         |         | Y527    | Y527G   |         |
| DT 100                                   | 76-80 | Y504    | Y504G     |          |          |         |         | Y506    | Y506G   |         |
| FIZ                                      | 97-   | FA275   | FA275HH   | TBA      |          |         |         | Y503    |         |         |
| RT 100 E/F/K                             | 93-03 | Y503    | Y503G     |          |          |         |         | Y503    | Y503G   |         |
| RS 100                                   | 75-80 | Y504    |           |          |          |         |         | Y504    |         |         |
| RS 100 DX                                | 77-80 | FA28    |           |          | N/A      |         |         | Y504    |         |         |
| RXS 100                                  | 83-97 | Y518    |           |          |          |         |         | Y518    |         |         |
| YB 100                                   | 78-81 | Y504    |           |          |          |         |         | Y504    |         |         |
| YB 100                                   | 82-86 | Y504    |           |          |          |         |         | Y503    |         |         |
| YB 100                                   | 87-92 | Y503    |           |          |          |         |         | Y503    |         |         |
| YN 100 "Neo's 100"                       | 99-03 | FA193   | FA193HH   | MD943D   |          |         |         | Y527    |         |         |
| YQ 100 "Aerox 100"                       | 00-04 | FA193   | FA193HH   | MD923D   |          |         |         | Y527    |         |         |
| YW 100 T Booster BWS                     | 96    | FA169   |           | N/A      |          |         |         | Y527    |         |         |
| YZ 100 E/F/G/H                           | 78-81 | Y504    | Y504G     |          |          |         |         | Y506    | Y506G   |         |
| YZ 100 J/K                               | 82-83 | Y503    | Y503G     |          |          |         |         | Y506    | Y506G   |         |
| T 105/105 E Crypton                      | 96    | Y518    |           |          |          |         |         | Y518    |         |         |
| T 105E (5ER1/2) Crypton-R                | 99    | FA275   | FA275HH   | MD963D   |          |         |         | Y518    |         |         |
| T 105 SE Crypton (SER3)                  | 02    | FA275   | FA275HH   | MD963D   |          |         |         | Y518    |         |         |
| Crypton 110cc                            | 04    | FA197   | FA197HH   | N/A      |          |         |         | Y518    |         |         |
| V 110 ZE/ZK/ZHE/ZHK FIZR/FIZR Sporty     | 96    | FA275   | FA275HH   | MD963D   |          |         |         | Y518    |         |         |
| MIO (113cc)                              | 05-07 | FA336   |           |          | TBA      |         |         | TBA     |         |         |
| MIO Sporty (113cc)                       | 05-07 | FA336   |           |          | TBA      |         |         | TBA     |         |         |
| Nouvo-Z (113cc)                          | 06-07 | FA336   |           |          | TBA      |         |         | TBA     |         |         |
| Neo AT 115                               | 05    | TBA     |           | TBA      |          |         |         | TBA     |         |         |
| BL 125 "Beluga"                          | 85    | Y521    |           |          |          |         |         | Y506    |         |         |
| DT 125 E/MX/LC                           | 74-85 | Y506    | Y506      |          |          |         |         | Y506    | Y506G   |         |
| DT 125 LC                                | 86-87 | FA101TT | FA101R■   | MD6067D  |          |         |         | Y506    | Y506G   |         |
| DT 125 R                                 | 88-03 | FA101TT | FA101R■   | MD6039D  |          |         | FA101TT | FA101R■ | MD6115D |         |
| DT 125 RE                                | 04    | FA101TT | FA101R    | MD6039D  |          |         | FA101TT | FA101R  | MD6115D |         |
| DT-Z 125 'Tenere/Tenere Scout'           | 89-90 | FA166   |           | N/A      |          |         | FA157   |         | N/A     |         |
| DT 125 Chesterfield Scout                | 89-90 | FA166   |           | N/A      |          |         | FA157   |         | N/A     |         |
| DT 125 (3TT4)                            | 96    | Y527    | Y527G     |          |          |         | Y527    | Y527G   |         |         |
| DT 125 RE                                | 05-07 | FA101TT | FA101R■   | MD6039D  |          |         | FA152TT | FA152R■ | MD6115D |         |
| DT 125 X                                 | 05-06 | FA209/2 | FA209/2HH | MD6235D  |          |         | FA152TT | FA152R■ | MD6115D |         |
| IT 125 G/H/J                             | 80-82 | Y504    | Y504G     |          |          |         | Y506    | Y506G   |         |         |
| RD 125 DX                                | 75-77 | FA28    |           |          | N/A      |         | Y506    |         |         |         |
| RD 125 DX                                | 78-81 | FA42    |           |          | N/A      |         | Y510    |         |         |         |
| RD 125 LC                                | 82-84 | FA81    |           |          | N/A      |         | Y506    |         |         |         |
| RD 125 LC (MK2/3)                        | 85-87 | FA104   | FA104HH   |          | MD2053RS |         | Y506    |         |         |         |
| RS 125                                   | 75    | Y510    |           |          |          |         | Y506    |         |         |         |
| RS 125 DX                                | 76-80 | FA28    |           |          | N/A      |         | Y506    |         |         |         |
| RS 125 DX                                | 81    | FA42    |           |          | N/A      |         | Y506    |         |         |         |
| RZ 125 (1GV 030101-)                     | 85    | FA104   | FA104HH   |          | MD2053RS |         | Y506    |         |         |         |
| SR 125 SE                                | 82    | Y506    |           |          |          |         | Y503    |         |         |         |
| SR 125 (3MW2 Type)                       | 89-91 | Y506    |           |          |          |         | Y503    |         |         |         |
|  |       | or Y527 |           |          |          |         | or Y518 |         |         |         |
| SR 125 SE                                | 92-96 | FA81    |           |          | N/A      |         | Y518    |         |         |         |
| SR 125                                   | 97-03 | FA199   | FA199HH   | MD2085LS |          |         | Y503    |         |         |         |
| TDR 125 R (4GW/GX1/2/3/4)                | 93-03 | FA199   | FA199HH   | MD6116D  |          |         | FA101TT |         | MD6115D |         |
| TDR 125 (3XD1/3SH)                       | 89-93 | FA134   |           | MD2003LS |          | MD2003C | FA173   |         | TBA     |         |
| TT-R 125 M/N/P/R/S/ES/T/ET/EV/EW         | 00-07 | Y503    | Y503G     |          |          |         | Y503    | Y503G   |         |         |
| TT-R 125 LWM/LWN/LWP/LWR/LWES/LWS        |       |         |           |          |          |         |         |         |         |         |
| /LWET/LWT/LV/LEV/LEW                     | 00-07 | FA119TT | FA119R    | MD6158D  |          | MD6158C | Y503    | Y503G   |         |         |
| TW 125                                   | 99-02 | FA275   | FA275HH   | MD6067D  |          |         | Y503    | Y503G   |         |         |

\*-2 Sets Required. ■ - Also available in MX-S race compound, see page 8. ✖ - Oversize and Supermoto disc available - see page 301.

**SAFETY WARNING:- DO NOT USE HH PADS ON REAR UNLESS ALSO USED ON FRONT TO AVOID BRAKE IMBALANCE.**

# JAPANESE Built Motorcycles



YAMAHA contd.

|  |       | Front/Avant/Vorn                   |                   |                     | Frente/Anteriere                                     |         | Rear/Arrière/Hinten                |          | Posterior/Posteriore          |   |
|--|-------|------------------------------------|-------------------|---------------------|--|---------|------------------------------------|----------|-------------------------------|---|
|  |       | 1                                  | 2                 | 3                   | 4  | 5       | 6                                  | 7        | 8                             | 9 |
|  |       | Sintered/HH Pads/<br>Grooved shoes | Left/Gauche/Links | Right/Droite/Rechts | Contour Rotor<br>Universal left<br>and right fitment |         | Sintered/HH Pads/<br>Grooved shoes |          | Contour Rotor<br>Rear fitment |   |
| TW 125 R/S                                   | 03-04 | FA275                              | FA275HH           | MD6067D             |  |         | Y531                               |          |                               |   |
| TY 125                                       | 82    | Y504                               | Y504G             |                     |  |         | Y506                               | Y506G    |                               |   |
| TZR 125                                      | 87-89 | FA104                              | FA104HH           |                     | MD2053RS   |         | Y506                               |          |                               |   |
| TZR 125                                      | 90-92 | FA88                               | FA88HH            |                     | MD2056RS   |         | FA104                              | FA104HH  | MD2021                        |   |
| TZR 125 R                                    | 93-   | FA252                              | FA252HH           |                     | MD2022RS   |         | FA104                              | FA104HH  | MD2021                        |   |
| TZR 125 RR                                   | 94-   | FA95                               | FA95HH            |                     | MD2003RS   | MD2003C | FA47                               | FA47HH   | MD2021                        |   |
| XC 125 'Beluga'                              | 92    | Y521                               |                   |                     |  |         | Y506                               |          |                               |   |
| XC 125 'Beluga'                              | 93-95 | Y521                               |                   |                     |  |         | Y527                               |          |                               |   |
| XC 125 T "Cygnus"                            | 96-   | Y527                               |                   |                     |  |         | Y503                               |          |                               |   |
| XC 125 TR "Cygnus"                           | 96-03 | FA101TT                            |                   |                     | N/A  |         | Y503                               |          |                               |   |
| XC 125 Cygnus X                              | 04-06 | FA393                              |                   |                     | MD986D   |         | Y533                               |          |                               |   |
| XN 125 N Teo's                               | 00-03 | FA193                              | FA193HH           | MD907D              |  |         | Y527                               |          |                               |   |
| XT 125                                       | 82    | Y506                               | Y506G             |                     |  |         | Y503                               | Y503G    |                               |   |
| XT 125 R                                     | 05-07 | FA350                              |                   | MD6297D             |  |         | FA350                              |          | MD6280D                       |   |
| XT 125 X                                     | 05-07 | FA194                              | FA194HH           | MD6297D             |  |         | FA350                              |          | MD6280D                       |   |
| XTZ 125 K/E                                  | 05-06 | FA197                              | FA197HH           | TBA                 |  |         | Y527                               |          |                               |   |
| Jog Teen                                     | 05    | TBA                                |                   |                     |  |         | TBA                                |          |                               |   |
| XV 125 "Virago"                              | 97-00 | FA199                              | FA199HH           | MD2067LS            |  |         | Y527                               |          |                               |   |
| XVS 125 Dragstar                             | 00-04 | FA199                              | FA199HH           |                     | MD2067RS   |         | Y527                               |          |                               |   |
| XQ 125/150 N Maxster                         | 01-03 | FA181TT                            | FA181HH           | MD957D              |  |         | FA266                              | FA266HH  | MD958D                        |   |
| YFA1W/A/B "Breeze"                           | 89-91 | Y503*                              | Y503G*            |                     |  |         | Y506                               | Y506G    |                               |   |
| YFA1D/F/G/H/J/K/L/M/N/P/R "Breeze"           | 92-03 | Y503*                              | Y503G*            |                     |  |         | Y527                               | Y527G    |                               |   |
| YBR 125 ED (3D91)                            | 05-07 | FA101                              |                   |                     | MD2097RS   |         | Y527                               |          |                               |   |
| YFM 125 S/GT/GV/GW Grizzly                   | 04-07 | Y503*                              | Y503G*            |                     |  |         | Y527                               | Y527G    |                               |   |
| YP 125 "Majesty"                             | 98-00 | FA181TT                            | FA181HH           | MD907D              |  |         | Y527                               |          |                               |   |
| YP 125 Majesty                               | 01-06 | FA181TT                            | FA181HH           | MD907D              |  |         | FA266                              | FA266HH  | MD962D                        |   |
| YP 125 Majesty FA (SCA9) (Taiwan Production) | 02    | FA196                              | FA196HH           |                     | MD979D   |         | Y527                               |          |                               |   |
| YP 125 Majesty (5XM1)                        | 04-07 | FA181TT                            | FA181HH           | MD907D              |  |         | FA266                              | FA266HH  | MD962D                        |   |
| YP 125 X-Max                                 | 06-07 | FA430                              |                   |                     | MD9102D  |         | FA266                              |          | MD9104D                       |   |
| YZ 125 C/D/E/F/G/H/J                         | 76-82 | Y507                               | Y507G             |                     |  |         | Y506                               | Y506G    |                               |   |
| YZ 125 K                                     | 83    | Y507                               | Y507G             |                     |  |         | Y517                               | Y517G    |                               |   |
| YZ 125 L                                     | 84    | Y508                               | Y508G             |                     |  |         | Y517                               | Y517G    |                               |   |
| YZ 125 N                                     | 85    | FA105TT                            | FA105R            | N/A                 |  |         | Y517                               | Y517G    |                               |   |
| YZ 125 S                                     | 86    | FA105TT                            | FA105R            | MD6067D             |  |         | Y517                               | Y517G    |                               |   |
| YZ 125 T                                     | 87    | FA105TT                            | FA105R            | MD6067D             |  |         | Y506                               | Y506G    |                               |   |
| YZ 125 U                                     | 88    | FA105TT                            | FA105R            | MD6039D             |  |         | FA101TT                            | FA101R   | MD6011D                       |   |
| YZ 125 W                                     | 89    | FA135TT                            | FA135R            | MD6016D             |  |         | →                                  | FA84/3R  | MD6011D                       |   |
| YZ 125 A/B                                   | 90-91 | FA135TT                            | FA135R            | MD6012D             |  |         | FA152TT                            | FA152R   | MD6011D                       |   |
| YZ 125 D/E/F/G/H/J                           | 92-97 | FA135TT                            | FA135R            | MD6028D             |  | MD6028C | FA152/2TT                          | FA152/2R | MD6011D                       |   |
| YZ 125 K/L/M                                 | 98-00 | FA185TT                            | FA185R            | MD6028D             |  | MD6028C | FA131TT                            | FA131R   | MD6135D                       |   |
| YZ 125 N                                     | 01    | FA185TT                            | FA185R            | MD6017D             |  | MD6017C | FA131TT                            | FA131R   | MD6135D                       |   |
| YZ 125 P                                     | 02    | FA185TT                            | FA185R            | MD6017D             |  | MD6017C | FA131TT                            | FA131R   | MD6190D                       |   |
| YZ 125 R/S                                   | 03-04 | FA185TT                            | FA185R            | MD6017D             |  | MD6017C | FA367TT                            | FA367R   | MD6190D                       |   |
| YZ 125 T/V/W                                 | 05-07 | FA185TT                            | FA185R            | MD6017D             |  | MD6017C | FA367TT                            | FA367R   | MD6190D                       |   |
| Supermoto version                            | 05-07 |                                    |                   | SM6528              |  |         |                                    |          |                               |   |
| RX 135 (13X)                                 | 81    | FA81                               |                   |                     | N/A  |         | Y506                               |          |                               |   |
| TZR 150 R (4AP2)                             | 00    | FA199                              | FA199HH           |                     | N/A  |         | FA104                              | FA104HH  | MD2021                        |   |
| DT 175 "All models"                          | 74-83 | Y506                               | Y506G             |                     |  |         | Y506                               | Y506G    |                               |   |
| DT 175 (3TS4)                                | 96    | Y527                               | Y527G             |                     |  |         | Y527                               | Y527G    |                               |   |
| IT 175 G/H/J                                 | 80-82 | Y507                               | Y507G             |                     |  |         | Y506                               | Y506G    |                               |   |
| TY 175                                       | 77-80 | Y504                               | Y504G             |                     |  |         | Y506                               | Y506G    |                               |   |
| AG 200 E (3GX6)                              | 93    | Y503                               | Y503G             |                     |  |         | Y527                               | Y527G    |                               |   |
| DT 200 (2LR)                                 | 87    | FA101TT                            | FA101R            | MD6067D             |  |         | Y506                               | Y506G    |                               |   |
| DT 200 R                                     | 93    | FA101TT                            | FA101R            | MD6039D             |  |         | FA101TT                            | FA101R   | MD6115D                       |   |
| DT 200 WR (3XP)                              | 92-93 | FA135TT                            | FA135R            | MD6066D             |  |         | FA152/2TT                          | FA152/2R | MD6121D                       |   |
| IT 200 L                                     | 84    | Y517                               | Y517G             |                     |  |         | Y517                               | Y517G    |                               |   |
| RD 200 DX                                    | 75-78 | FA28                               |                   | N/A                 |  |         | Y510                               |          |                               |   |
| RD 200 DX                                    | 78-80 | FA42                               |                   | N/A                 |  |         | Y510                               |          |                               |   |
| RS 200                                       | 79    | Y510                               |                   |                     |  |         | Y510                               |          |                               |   |
| SDR 200 (2TV)                                | 87-89 | FA104                              | FA104HH           |                     | MD2056RS   |         | FA104                              | FA104HH  | MD2021                        |   |

\*-2 Sets Required. ■ - Also available in MX-S race compound, see page 8. ✕ - Oversize and Supermoto disc available - see page 301.

**SAFETY WARNING:- DO NOT USE HH PADS ON REAR UNLESS ALSO USED ON FRONT TO AVOID BRAKE IMBALANCE.**

R Suffix = High Durability Sintered Pad. HH Suffix = High Performance Sintered Pad. G Suffix = Grooved Shoe.  
D Suffix = Drilled Disc. C Suffix = Contoured Disc. LS Suffix = Left/Steel Disc. RS = Right/Steel Disc.

BRAKE APPLICATIONS

# JAPANESE Built Motorcycles

APPLICATIONS

BRAKE



| Front/Avant/Vorn               |                   | Frente/Anteriere    |  |                                | Rear/Arrière/Hinten        |   | Posterior/Posteriore |   |
|--------------------------------|-------------------|---------------------|--|--------------------------------|----------------------------|---|----------------------|---|
| 1                              | 2                 | 3                   | 4  | 5                              | 6                          | 7 | 8                    | 9 |
| Sintered/HH Pads/Grooved shoes | Left/Gauche/Links | Right/Droite/Rechts | Contour Rotor Universal left and right fitment | Sintered/HH Pads/Grooved shoes | Contour Rotor Rear fitment |   |                      |   |

**YAMAHA** contd.

|  |       |         |          |          |          |         |      |           |          |         |         |
|--|-------|---------|----------|----------|----------|---------|------|-----------|----------|---------|---------|
| TW 200 (2JL/4C51/2/3/4/5/6/5LB1/2)           | 01-02 | FA275   | FA275HH  | MD6067D  |          |         | Y503 | FA21      | FA21R    | N/A     |         |
| YFM 200 N                                    | 85    | Y503*   | Y503G*   |          |          |         |      | FA21      | FA21R    | N/A     |         |
| YFM 200 DXW/DX/DXA                           | 89-90 | Y503*   | Y503G*   |          |          |         |      | FA155     | FA155R   | MD6050D |         |
| YFS 200 B/F/G/H/J/K/L/M/N/P "Blaster"        | 91-02 | Y503*   | Y503G*   |          |          |         |      | FA84TT    | FA84R    | MD6237D |         |
| YFS 200 R/S/T/V Blaster                      | 03-06 | FA54TT* | FA54R*   | MD6054D  | MD6054D  |         |      | FA21      | FA21R    | N/A     |         |
| YTM 200 EL/DX                                | 89    | Y503    | Y503G    |          |          |         |      | FA152TT   | FA152R   | MD6121D |         |
| WR 200 D/E/F                                 | 92-94 | FA135TT | FA135R   |          | MD6066D  |         |      | Y503      | Y503G    |         |         |
| ST 225 (5BT) Bronco                          | 97    | FA275   | FA275HH  | MD6067D  |          |         |      | TBA       |          |         |         |
| TDM 225                                      | 05    | TBA     |          | TBA      |          |         |      |           |          |         |         |
| TW 225 E (5VC1/2)                            | 03    | FA275   | FA275HH  | MD6067D  |          |         |      | Y531      |          |         |         |
| YFM 225 S/T/U                                | 86-89 | Y503*   | Y503G*   |          |          |         |      | FA21      | FA21R    | N/A     |         |
| YTM 225 DRN                                  | 85    | Y503    | Y503G    |          |          |         |      | FA21      | FA21R    | N/A     |         |
| XT 225 W (4JGI-6 Serrow)                     | 93-98 | FA101TT | FA101R   | MD6067D  |          |         |      | FA152/2TT | FA152/2R | MD6244D |         |
| XT 225 (2LN) (1KH 020101-) Serrow            | 86-87 | FA101TT | FA101R   | MD6067D  |          |         |      | Y503      | Y503G    |         |         |
| XT 225 (3RW1-5 Serrow) (1KH 034101 - 132000) | 89-93 | FA101TT | FA101R   | MD6067D  |          |         |      | Y503      | Y503G    |         |         |
| DT 230 (4TP1/2) "Lanza"                      | 97-98 | FA135TT | FA135R   | MD6066D  |          |         |      | FA152/2TT | FA152/2R | MD6121D |         |
| CP 250 (1B71) Maxam/Morphus                  | 05    | FA179   | FA179HH  |          | MD9107D  |         |      | FA408     |          | MD9108D |         |
| DT 250 "All models"                          | 75-80 | Y511    | Y511G    |          |          |         |      | Y510      | Y510G    |         |         |
| FZR 250                                      | 87    | FA123   | FA123HH  |          | MD2003RS | MD2003C |      | FA104     | FA104HH  | MD2021  |         |
| FZR 250 R (3LN)                              |       | FA220*  |          | MD2022LS | MD2022RS |         |      | FA104     |          | MD2021  |         |
| FZX 250 (3YX1/2/4) Zeal                      | 91-92 | FA179   | FA179HH  |          | TBA      |         |      | FA104     | FA104HH  | MD2021  |         |
| IT 250 G                                     | 80    | Y507    | Y507G    |          |          |         |      | Y511      | Y511G    |         |         |
| IT 250 H/J                                   | 81-82 | Y507    | Y507G    |          |          |         |      | Y510      | Y510G    |         |         |
| IT 250 L                                     | 84    | Y508    | Y508G    |          |          |         |      | Y510      | Y510G    |         |         |
| RD 250 A/B/C                                 | 75-77 | FA11    |          |          | N/A      |         |      | Y514      |          |         |         |
| RD 250 D                                     | 77    | FA11    |          |          | N/A      |         |      | FA11      |          | N/A     |         |
| RD 250 E/F                                   | 78-79 | FA41    |          |          | MD2025RS |         |      | FA41      |          | MD2025  |         |
| RD 250 LC                                    | 80    | FA64    |          |          | MD2019RS |         |      | Y514      |          |         |         |
| RD 250 LC                                    | 80-83 | FA70    |          |          | MD2019RS |         |      | Y514      |          |         |         |
| RZ 250 R (1AR/1XG)                           |       | FA104*  | FA104HH* | MD2011LS | MD2011RS |         |      | FA104     | FA104HH  | MD2011  |         |
| RZ 250 R (29L)                               |       | FA81*   |          | MD2011LS | MD2011RS |         |      | FA104     |          | MD2011  |         |
| RZ 250 RR (5IL)                              |       | FA104*  | FA104HH* | MD2011LS | MD2011RS |         |      | FA104     | FA104HH  | MD2011  |         |
| RZ 250 (4L3)                                 |       | FA70    |          |          | MD2019RS |         |      | Y514      |          |         |         |
| Serrow 250 (3C51/52)                         | 05    | FA275   | FA275HH  | TBA      |          |         |      | FA152TT   | FA152R   | TBA     |         |
| SR 250 SE                                    | 80-82 | Y511    |          |          |          |         |      | Y506      |          |         |         |
| SR 250                                       | 93-94 | Y511    |          |          |          |         |      | Y506      |          |         |         |
| SRV 250 "Souffultwin/Renaissa" (4DN1-6)      | 92-97 | FA179   | FA179HH  | MD2067LS |          |         |      | Y527      |          |         |         |
| SRX 250 (51Y/52E/1JA)                        |       | FA104   | FA104HH  |          | MD2056RS |         |      | Y510      |          |         |         |
| TDR 250                                      | 88-92 | FA123   | FA123HH  |          | MD2003RS | MD2003C |      | FA104     | FA104HH  | MD2021  |         |
| TT 250 R (4GY) Raid/4MR2                     | 96    | FA135TT | FA135R   | MD6066D  |          |         |      | FA152/2TT | FA152/2R | MD6121D |         |
| TT 250 RL/RM/RN/RP/RR/RS                     | 99-04 | FA135TT | FA135R   | MD6066D  |          |         |      | FA152/2TT | FA152/2R | MD6121D |         |
| TT 250                                       | 90    | FA105TT | FA105R   | MD6039D  |          |         |      | Y506      | Y506G    |         |         |
| TY 250 D/E                                   | 77-78 | Y504    | Y504G    |          |          |         |      | Y506      | Y506G    |         |         |
| TY 250 H                                     | 81    | Y507    | Y507G    |          |          |         |      | Y510      | Y510G    |         |         |
| TY 250 S/R                                   | 84-90 | Y517    | Y517G    |          |          |         |      | Y504      | Y504G    |         |         |
| TY 250 R                                     | 91-92 | FA115   | FA115R   | N/A      |          |         |      | Y504      | Y504G    |         |         |
| TY 250 R                                     | 93-94 | FA115   | FA115R   | N/A      |          |         |      | FA115     | FA115R   | N/A     |         |
| TYZ 250 R                                    | 93-96 | FA115   | FA115R   | N/A      |          |         |      | FA115     | FA115R   | N/A     |         |
| TZR 250 (3MAI)                               | 89    | FA252*  | FA252HH* | MD2001LS | MD2001RS |         |      | FA104     | FA104HH  | MD2021  |         |
| TZR 250 (3MA3/A5)                            | 90    | FA252*  | FA252HH* | MD2022LS | MD2022RS |         |      | FA104     | FA104HH  | MD2021  |         |
| TZR 250 SP (3MA4)                            | 90    | FA252*  | FA252HH* | MD2022LS | MD2022RS |         |      | FA104     | FA104HH  | MD2021  |         |
| TZR 250 R (3XV1/4/6)                         | 91    | FA252*  | FA252HH* | MD2022LS | MD2022RS |         |      | FA104     | FA104HH  | MD2021  |         |
| TZR 250 RS (3XV8/9)                          | 92-94 | FA252*  | FA252HH* | MD2022LS | MD2022RS |         |      | FA104     | FA104HH  | MD2021  |         |
| TZR 250 RS/SPR (3XVA/3XVC)                   | 95-96 | FA252*  | FA252HH* | MD2022LS | MD2022RS |         |      | FA104     | FA104HH  | MD2021  |         |
| TZR 250 (2MA/2XW)                            | 87-92 | FA123   | FA123HH  |          | MD2003RS | MD2003C |      | FA104     | FA104HH  | MD2021  |         |
| TZR 250 (1KT/2AW)                            | 87    | FA123   | FA123HH  |          | MD2003RS | MD2003C |      | FA104     | FA104HH  | MD2021  |         |
| VP 250 W (X-City)                            | 07    | FA196   | FA196HH  | TBA      |          |         |      | FA275     | FA275HH  | TBA     |         |
| WR 250 ZB/ZD/ZE/ZF/ZG/ZH/ZJ                  | 91-97 | FA135TT | FA135R   | MD6028D  |          | MD6028C |      | FA152TT   | FA152R   | MD6011D |         |
| WR 250 ZK (5EN1)                             | 98    | FA185TT | FA185R   | MD6028D  |          | MD6028C |      | FA131TT   | FA131R   | MD6135D | MD6135C |
| WR 250 FN                                    | 01    | FA185TT | FA185R   | MD6017D  |          | MD6017C |      | FA131TT   | FA131R   | MD6135D | MD6135C |

\*-2 Sets Required. ■ - Also available in MX-S race compound, see page 8. ✖ - Oversize and Supermoto disc available - see page 301.

**SAFETY WARNING:- DO NOT USE HH PADS ON REAR UNLESS ALSO USED ON FRONT TO AVOID BRAKE IMBALANCE.**

# JAPANESE Built Motorcycles



YAMAHA contd.



|   |       | Front/Avant/Vorn               |                                |                   | Frente/Anteriore    |  | Rear/Arrière/Hinten            |                                | Posterior/Posteriore       |                            |
|---|-------|--------------------------------|--------------------------------|-------------------|---------------------|--|--------------------------------|--------------------------------|----------------------------|----------------------------|
|   |       | 1                              | 2                              | 3                 | 4                   | 5  | 6                              | 7                              | 8                          | 9                          |
|   |       | Sintered/HH Pads/Grooved shoes | Sintered/HH Pads/Grooved shoes | Left/Gauche/Links | Right/Droite/Rechts | Contour Rotor Universal left and right fitment | Sintered/HH Pads/Grooved shoes | Sintered/HH Pads/Grooved shoes | Contour Rotor Rear fitment | Contour Rotor Rear fitment |
| WR 250 FP   | 02    | FA185TT                        | FA185R■                        | MD6017D×          |                     | MD6017C  | FA131TT                        | FA131R■                        | MD6190D                    | MD6190C                    |
| WR 250 FR/FS                                      | 03-04 | FA185TT                        | FA185R■                        | MD6017D×          |                     | MD6017C  | FA367TT                        | FA367R■                        | MD6190D                    | MD6190C                    |
| WR 250 FT/FV/FW                                   | 05-07 | FA185TT                        | FA185R■                        | MD6017D×          |                     | MD6017C  | FA367TT                        | FA367R■                        | MD6190D                    | MD6190C                    |
| Supermoto version                                 | 05-07 |                                |                                | SM6528            |                     |  |                                |                                |                            |                            |
| XG 250 Tricker (5XT1)                             | 04-06 | FA275                          | FA275HH                        | MD6067D           |                     |  | FA152TT                        | FA152R■                        | MD6244D                    |                            |
| YP 250 X-Max                                      | 05-07 | FA430                          |                                |                   | MD9102D             |  | FA275                          |                                | MD9104D                    |                            |
| XS 250 C  | 78    | FA34                           |                                |                   | MD2019RS            |  | FA34                           |                                | MD2019                     |                            |
| XS 250 D/E  | 79-81 | FA34                           |                                |                   | MD2019RS            |  | Y516                           |                                |                            |                            |
| XS 250 SE/SF                                      | 79-81 | FA41                           |                                |                   | MD2019RS            |  | Y516                           |                                |                            |                            |
| XS 250 C  | 81    | Y513                           |                                |                   |                     |  | Y516                           |                                |                            |                            |
| XT 250  | 80    | Y506                           | Y506G                          |                   |                     |  | Y506                           | Y506G                          |                            |                            |
| XT 250 X  | 06    | FA275                          | FA275HH                        | TBA               |                     |  | FA152TT                        | FA152R                         | TBA                        |                            |
| XV 250 "S" Virago                                 | 95-00 | FA199                          | FA199HH                        | MD2067LS          |                     |  | Y527                           |                                |                            |                            |
| XV 250 Virago                                     | 89-94 | FA81                           |                                |                   | MD2019RS            |  | Y527                           |                                |                            |                            |
| XVS 250 Dragster                                  | 01-03 | FA199                          | FA199HH                        |                   | MD2067RS            |  | Y527                           |                                |                            |                            |
| YBR 250   | 07    | FA197                          | FA197HH                        |                   | TBA                 |  | Y527                           |                                |                            |                            |
| YDS-7   | 73-75 | Y513                           |                                |                   |                     |  | Y514                           |                                |                            |                            |
| YFB 250 D/E/F "Timberwolf"                        | 92-94 | Y503*                          | Y503G*                         |                   |                     |  | Y528                           | Y528G                          |                            |                            |
| YFB 250 G/H/UH/J/UJ/UK/K "Timberwolf"             | 95-98 | Y528*                          | Y528G*                         |                   |                     |  | Y528                           | Y528G                          |                            |                            |
| YFB 250 FW/FWJ/FWJH/FWJL/FWK/FWL/FWK "Timberwolf" | 94-00 | Y528*                          | Y528G*                         |                   |                     |  | Y528                           | Y528G                          |                            |                            |
| YFM 250 W/A/B                                     | 90-92 | Y528*                          | Y528G*                         |                   |                     |  | FA21                           | FA21R                          | N/A                        |                            |
| YFM 250 XLC/XLX "Bear Tracker"                    | 99-00 | Y528*                          | Y528G*                         |                   |                     |  | Y528                           | Y528G                          |                            |                            |
| YFM 250 XN/XP/XR/XS Bear Tracker                  | 01-04 | FA54TT*                        | FA54R*                         | MD6054D           | MD6054D             |  | Y528                           | Y528G                          |                            |                            |
| YFM 250 BT/BV Bruin                               | 05-06 | FA54TT*                        | FA54R*                         | MD6054D           | MD6054D             |  | Y532                           | Y532G                          |                            |                            |
| YFM 250 BW Big Bear                               | 07    | FA54TT*                        | FA54R*■                        | MD6054D           | MD6054D             |  | Y532                           | Y532G                          |                            |                            |
| YP 250 "Majesty"                                  | 96-98 | FA199                          | FA199HH                        |                   | MD903D              |  | Y516                           |                                |                            |                            |
| YP 250 DX/A "Majesty"                             | 98-99 | FA199                          | FA199HH                        |                   | MD903D              |  | FA275                          | FA275HH                        | MD927D                     |                            |
| YP 250 Majesty                                    | 00-03 | FA199                          | FA199HH                        |                   | MD903D              |  | FA275                          | FA275HH                        | MD953D                     |                            |
| YTZ 250 N/S "TR1-Z"                               | 85-86 | FA101TT                        | FA101R■                        | N/A               | N/A                 |  | FA101TT                        | FA101R■                        | N/A                        |                            |
| YZ 250 D/E/F                                      | 77-79 | Y507                           |                                |                   |                     |  | Y511                           | Y511G                          |                            |                            |
| YZ 250 G  | 80    | Y507                           | Y507G                          |                   |                     |  | Y506                           | Y506G                          |                            |                            |
| YZ 250 J/K/L                                      | 81-84 | Y508                           | Y508G                          |                   |                     |  | Y506                           | Y506G                          |                            |                            |
| YZ 250 N  | 85    | FA105TT                        | FA105R                         | N/A               |                     |  | Y506                           | Y506G                          |                            |                            |
| YZ 250 S/T  | 86-87 | FA105TT                        | FA105R                         | MD6067D           |                     |  | Y506                           | Y506G                          |                            |                            |
| YZ 250 U  | 88    | FA105TT                        | FA105R                         | MD6039D           |                     |  | FA101TT                        | FA101R■                        | MD6011D                    |                            |
| YZ 250 W/WRW                                      | 89    | FA135TT                        | FA135R■                        | MD6016D           |                     |  | →                              | FA84/3R                        | MD6011D                    |                            |
| YZ 250 A/WRA/B                                    | 90-91 | FA135TT                        | FA135R■                        | MD6012D           |                     |  | FA152TT                        | FA152R■                        | MD6011D                    |                            |
| YZ 250 D/E/F/G/H/J                                | 92-97 | FA135TT                        | FA135R■                        | MD6028D×          |                     | MD6028C  | FA152/2TT                      | FA152/2R■                      | MD6011D                    |                            |
| YZ 250 K/L/M                                      | 98-00 | FA185TT                        | FA185R■                        | MD6028D×          |                     | MD6028C  | FA131TT                        | FA131R■                        | MD6135D                    | MD6135C                    |
| YZ 250 N  | 01    | FA185TT                        | FA185R■                        | MD6017D×          |                     | MD6017C  | FA131TT                        | FA131R■                        | MD6135D                    | MD6135C                    |
| YZ 250 FN   | 01    | FA185TT                        | FA185R■                        | MD6017D×          |                     | MD6017C  | FA131TT                        | FA131R■                        | MD6135D                    | MD6135C                    |
| YZ 250 P  | 02    | FA185TT                        | FA185R■                        | MD6017D×          |                     | MD6017C  | FA131TT                        | FA131R■                        | MD6190D                    | MD6190C                    |
| YZ 250 FP   | 02    | FA185TT                        | FA185R■                        | MD6017D×          |                     | MD6017C  | FA131TT                        | FA131R■                        | MD6190D                    | MD6190C                    |
| YZ 250 R/S  | 03-04 | FA185TT                        | FA185R■                        | MD6017D×          |                     | MD6017C  | FA367TT                        | FA367R■                        | MD6190D                    | MD6190C                    |
| YZ 250 FR/FS                                      | 03-04 | FA185TT                        | FA185R■                        | MD6017D×          |                     | MD6017C  | FA367TT                        | FA367R■                        | MD6190D                    | MD6190C                    |
| YZ 250 TV/W                                       | 05-07 | FA185TT                        | FA185R■                        | MD6017D×          |                     | MD6017C  | FA367TT                        | FA367R■                        | MD6190D                    | MD6190C                    |
| YZ 250 FT/FV                                      | 05-06 | FA185TT                        | FA185R■                        | MD6017D×          |                     | MD6017C  | FA367TT                        | FA367R■                        | MD6190D                    | MD6190C                    |
| Supermoto version                                 | 05-07 |                                |                                | SM6528            |                     |  |                                |                                |                            |                            |
| YZ 250 FW   | 07    | FA450TT                        | FA450R■                        |                   |                     | MD6017C  | FA367TT                        | FA367R■                        |                            | MD6190C                    |
| Supermoto version                                 | 07    |                                |                                | SM6728×           |                     |  |                                |                                |                            |                            |
| VP 300 R/S/T/V Versity                            | 03-06 | FA181TT                        | FA181HH                        |                   | MD995D              |  | FA181TT                        | FA181HH                        | MD9104D                    |                            |
| RD 350 A/B  | 74-76 | FA11                           |                                |                   | N/A                 |  | Y514                           |                                |                            |                            |
| RD 350 LC   | 80    | FA64*                          |                                | MD2019LS          | MD2019RS            |  | Y514                           |                                |                            |                            |
| RD 350 LC   | 81-82 | FA70*                          |                                | MD2019LS          | MD2019RS            |  | Y514                           |                                |                            |                            |
| RD 350 YPVS                                       | 83-84 | FA81*                          |                                | MD2011LS          | MD2011RS            |  | FA88                           |                                | MD2011                     |                            |
| RD 350 F/F2                                       | 85-92 | FA104*                         | FA104HH*                       | MD2011LS          | MD2011RS            |  | FA104                          | FA104HH*                       | MD2011                     |                            |
| RD 350 N  | 85    | FA104*                         | FA104HH*                       | MD2011LS          | MD2011RS            |  | FA104                          | FA104HH*                       | MD2011                     |                            |
| RD 350 R  | 92-95 | FA104*                         | FA104HH*                       | MD2011LS          | MD2011RS            |  | FA104                          | FA104HH*                       | MD2011                     |                            |
| RIZ 350   | 92    | FA220*                         |                                | TBA               | TBA                 |  | FA104                          |                                | MD2021                     |                            |
| TT 350 A (3GJ)                                    | 90-95 | FA105TT                        | FA105R                         | MD6039D           |                     |  | Y527                           | Y527G                          |                            |                            |

\*-2 Sets Required. ■ - Also available in MX-S race compound, see page 8. ✕ - Oversize and Supermoto disc available - see page 301.

**SAFETY WARNING:- DO NOT USE HH PADS ON REAR UNLESS ALSO USED ON FRONT TO AVOID BRAKE IMBALANCE.**

R Suffix = High Durability Sintered Pad. HH Suffix = High Performance Sintered Pad. G Suffix = Grooved Shoe.  
D Suffix = Drilled Disc. C Suffix = Contoured Disc. LS Suffix = Left/Steel Disc. RS = Right/Steel Disc.

BRAKE APPLICATIONS

# JAPANESE Built Motorcycles

APPLICATIONS

BRAKE



| Front/Avant/Vorn                   |                   | Frente/Anteriore    |  |  | Rear/Arrière/Hinten           |   | Posterior/Posteriore |   |
|------------------------------------|-------------------|---------------------|--|--|-------------------------------|---|----------------------|---|
| 1                                  | 2                 | 3                   | 4  | 5                                      | 6                             | 7 | 8                    | 9 |
| Sintered/HH Pads/<br>Grooved shoes | Left/Gauche/Links | Right/Droite/Rechts | Contour Rotor<br>Universal left<br>and right fitment | Sintered/<br>HH Pads/<br>Grooved shoes | Contour Rotor<br>Rear fitment |   |                      |   |

**YAMAHA** contd.

|   |              |                |                 |                 |                 |                 |                |                |                |                |
|---|--------------|----------------|-----------------|-----------------|-----------------|-----------------|----------------|----------------|----------------|----------------|
| XT 350  | 85-90        | FA101TT        | FA101R          | MD6068D         |                 |                 | Y506           | Y506G          |                |                |
| XT 350  | 91-95        | FA101TT        | FA101R          | MD6068D         |                 |                 | Y527           | Y527G          |                |                |
| YFM 350 FWT/FWU "Big Bear"                        | 87-88        | Y520*          | Y520G*          |                 |                 |                 | FA21           | FA21R          | N/A            |                |
| YFM 350 FWW/FWA/FWA/FWB/FWD                       |              |                |                 |                 |                 |                 |                |                |                |                |
| /FWE/FWF/FWG                                      | 89-95        | Y524*          | Y524G*          |                 |                 |                 | FA21           | FA21R          | N/A            |                |
| YFM 350 FWH/FWJ/FWK "Big Bear"                    | 96-98        | Y524*          | Y524G*          |                 |                 |                 | Y516           |                |                |                |
| YFU1W/YFU1-T                                      | 89-90        | Y528*          | Y528G*          |                 |                 |                 | Y523*          | Y523G*         |                |                |
| YFM 350 XD/XE/XF/XG/XH/XJ/XK                      |              |                |                 |                 |                 |                 |                |                |                |                |
| /XL/XM/XN/XP/XR/XS                                | 92-04        | FA54TT*        | FA54R*■         | MD6054D         | MD6054D         |                 | FA84TT         | FA84R          | MD6055D        |                |
| YFM 350 ERD                                       | 92           | Y528*          | Y528G*          |                 |                 |                 | FA21           | FA21R          | N/A            |                |
| YFM 350 ERE/ERF/ERG                               | 93-95        | Y528*          | Y528G*          |                 |                 |                 | FA21           | FA21R          | N/A            |                |
| YFM 350 FXG/FXH/FXJ/FXK/FXL/FXM/FXN               |              |                |                 |                 |                 |                 |                |                |                |                |
| /FXP/FXR/FXS "Wolverine"                          | 95-04        | FA54TT*        | FA54R*■         | MD6123D         | MD6123D         |                 | FA84TT         | FA84R          | MD6053D        |                |
| <b>YFM 350 FGW Grizzly</b>                        | <b>07</b>    | <b>FA54TT*</b> | <b>FA54R*■</b>  | <b>MD6215D</b>  | <b>MD6215D</b>  |                 | <b>Y532</b>    | <b>Y532G</b>   |                |                |
| YFM 350 UH/UJ/UK                                  | 96-98        | Y524*          | Y524G*          |                 |                 |                 | Y528           | Y528G          |                |                |
| YFM 350 L Big Bear                                | 99           | FA54TT*        | FA54R*■         | MD6123D         | MD6123D         |                 | 516            | 516G           |                |                |
| YFM 350 FAS/FAT/FAV Bruin 4x4                     | 04-06        | FA54TT*        | FA54R*■         | MD6215D         | MD6215D         |                 | Y532           | Y532G          |                |                |
| YFM 350 ANS/ANT/ANV Bruin 2x4                     | 04-06        | FA54TT*        | FA54R*■         | MD6215D         | MD6215D         |                 | Y532           | Y532G          |                |                |
| YFM 350 S/T/V/RWV/RW Raptor                       | <b>04-07</b> | FA84TT         | FA84R■          | MD6054D         | MD6054D         |                 | FA84TT         | FA84R■         | MD6236D        |                |
| YFZ 350 U/B/D/E/F/G/H/J/K/L/M/N/P/R/S/T "Banshee" | 88-06        | FA54TT*        | FA54R*■         | MD6054D         | MD6054D         |                 | FA84TT         | FA84R■         | MD6237D        |                |
| XS 360 B  | 75           | FA11           |                 |                 | N/A             |                 | Y514           |                |                |                |
| XS 360 C  | 76           | FA34           |                 | MD2019RS        |                 |                 | FA34           |                | MD2019         |                |
| DT 400 "All models"                               | 75-77        | Y511           | Y511G           |                 |                 |                 | Y510           | Y510G          |                |                |
| FZ 400 N (IKF/46K/33M)                            | 85           | FA88*          | FA88HH*         | MD2011LS        | MD2011RS        |                 | FA104          | FA104HH        | MD2002         |                |
| FZ 400  | 96           | FA244*         | FA244HH*        | MD2001LS        | MD2001RS        | MD2001C*        | FA88           | FA88HH         | MD2002         | MD2002C        |
| FZR 400 Genesis (1WG)                             |              |                |                 |                 |                 |                 |                |                |                |                |
| <b>F/No 1WG 000101-0305100</b>                    | 86           | FA88*          | FA88HH*         | MD2020LS        | MD2020RS        |                 | FA104          | FA104HH        | MD2021         |                |
| FZR 400 RSP (2TK-EXUP)                            |              |                |                 |                 |                 |                 |                |                |                |                |
| <b>F/No 1WG 0305101-043100</b>                    | 87           | FA123*         | FA123HH*        | MD2022LS        | MD2022RS        |                 | FA104          | FA104HH        | MD2021         |                |
| FZR 400 (3EN1)                                    |              |                |                 |                 |                 |                 |                |                |                |                |
| <b>F/No 1WG 043101-080100</b>                     | 88           | FA123*         | FA123HH*        | MD2022LS        | MD2022RS        |                 | FA104          | FA104HH        | MD2021         |                |
| FZR 400 R (3EN2)                                  |              |                |                 |                 |                 |                 |                |                |                |                |
| <b>F/No 1WG 080101-</b>                           | 89           | FA123*         | FA123HH*        | MD2001LS        | MD2001RS        | MD2001C*        | FA104          | FA104HH        | MD2021         |                |
| FZR 400 RR (3TJ1)                                 |              | FA252*         | FA252HH*        | MD2001LS        | MD2001RS        | MD2001C*        | FA104          | FA104HH        | MD2021         |                |
| FZR 400 RRSP (3TJ2/6/7) (ITJ)                     |              | FA252*         | FA252HH*        | MD2001LS        | MD2001RS        | MD2001C*        | FA104          | FA104HH        | MD2021         |                |
| FZR 400 RR (4DX)                                  | 92           | FA252*         | FA252HH*        | MD2001LS        | MD2001RS        | MD2001C*        | FA104          | FA104HH        | MD2021         |                |
| RD 400 C/D  | 76-77        | FA11           |                 |                 | N/A             |                 | FA11           |                | N/A            |                |
| RD 400 E/F  | 78-79        | FA41           |                 |                 | MD2025RS        |                 | FA41           |                | MD2025         |                |
| SR 400 (3HT1)                                     | 88           | Y526           |                 |                 |                 |                 | Y510           |                |                |                |
| SR 400 (BC-RH01J)                                 |              | FA179          | FA179HH         |                 | TBA             |                 | Y510           |                |                |                |
| SRX 400 (1JL)                                     | 85           | FA88           | FA88HH          |                 | MD2011RS        |                 | FA104          | FA104HH        | MD2002         |                |
| SRX 400 (3VN1/3VN2/3VN5)                          | 90-96        | FA123          | FA123HH         |                 | MD2003RS        | MD2003C         | FA104          | FA104HH        | MD2002         | MD2002C        |
| <b>XJR 400 (4HM1/4HM2/4HM4/4HM7)</b>              | <b>93-96</b> | <b>FA199*</b>  | <b>FA199HH*</b> | <b>MD2001LS</b> | <b>MD2001RS</b> | <b>MD2001C*</b> | <b>FA104</b>   | <b>FA104HH</b> | <b>MD2002</b>  | <b>MD2002C</b> |
| <b>XJR 400 (4HM3/4HM5/4HM6/4HM9</b>               |              |                |                 |                 |                 |                 |                |                |                |                |
| <b>/4HMA/4HMB) Brembo calipers</b>                | <b>95-99</b> | <b>FA244*</b>  | <b>FA244HH*</b> | <b>MD2001LS</b> | <b>MD2001RS</b> | <b>MD2001C*</b> | <b>FA104</b>   | <b>FA104HH</b> | <b>MD2002</b>  | <b>MD2002C</b> |
| XS 400 C  | 78           | FA34           |                 |                 | MD2019RS        |                 | FA34           |                | MD2019         |                |
| XS 400  | 79           | FA34           |                 |                 | MD2019RS        |                 | Y516           |                |                |                |
| XS 400 SE   | 80-81        | FA41           |                 |                 | MD2019RS        |                 | Y516           |                |                |                |
| XS 400  | 82           | FA81           |                 |                 | MD2011RS        |                 | Y516           |                |                |                |
| XVS 400   | 96           | FA179          | FA179HH         |                 | MD2076RS        |                 | Y515           |                |                |                |
| YFM 400 FWE/FWF/FWG/FWH/FWJ/FWK/FWL "Kodiak"      | 93-99        | Y524*          | Y524G*          |                 |                 |                 | Y516           | Y516G          |                |                |
| YFM 400 FAM/FAN                                   | 00-01        | FA54TT*        | FA54R*■         | MD6123D         | MD6123D         |                 | FA307TT        | FA307R         | MD6174D        |                |
| YFM 400 FWP Big Bear 4x4                          | 02           | FA84TT*        | FA84R*■         | MD6123D         | MD6123D         |                 | Y516           | Y516G          |                |                |
| YFM 400 FPR/FPS Big Bear                          | 03-04        | FA54TT*        | FA54R*■         | MD6123D         | MD6123D         |                 | Y516           | Y516G          |                |                |
| YFM 400 FAR/FAS Kodiak Auto                       | 03-04        | FA54TT*        | FA54R*■         | MD6215D         | MD6215D         |                 | Y516           | Y516G          |                |                |
| YFM 400 AR Kodiak (5VH3/4)                        | 03           | FA54TT*        | FA54R*■         | MD6215D         | MD6215D         |                 | Y532           | Y532G          |                |                |
| YFM 400 FAT/FAV (Big Bear)                        | 05-06        | FA54TT*        | FA54R*■         | MD6215D         | MD6215D         |                 | FA307TT        | FA307R         | MD6252D        |                |
| <b>YFM 400 FGW Grizzly</b>                        | <b>07</b>    | <b>FA54TT*</b> | <b>FA54R*■</b>  | <b>MD6054D</b>  | <b>MD6054D</b>  |                 | <b>FA307TT</b> | <b>FA307R</b>  | <b>MD6252D</b> |                |
| YP 400 S/T Majesty (5RU1/3)                       | 04           | FA179          | FA179HH         | MD9102D         |                 |                 | FA408          |                | MD9103D        |                |
| YP 400 T/V/W Majesty                              | <b>05-07</b> | FA199*         | FA199HH*        | MD9102D         | MD9102D         |                 | FA408          |                | MD9103D        |                |

\*-2 Sets Required. ■ - Also available in MX-S race compound, see page 8. ✖ - Oversize and Supermoto disc available - see page 301.

**SAFETY WARNING:- DO NOT USE HH PADS ON REAR UNLESS ALSO USED ON FRONT TO AVOID BRAKE IMBALANCE.**

# JAPANESE Built Motorcycles



YAMAHA contd.

|                                 |            | Front/Avant/Vorn |                                    |                       | Frente/Anteriore        |  | Rear/Arrière/Hinten |                                    | Posterior/Posteriore |                               |
|---------------------------------|------------|------------------|------------------------------------|-----------------------|-------------------------|--|---------------------|------------------------------------|----------------------|-------------------------------|
|                                 |            | 1                | 2                                  | 3                     | 4                       | 5  | 6                   | 7                                  | 8                    | 9                             |
|                                 |            |                  | Sintered/HH Pads/<br>Grooved shoes | Left/Gauche/Links<br> | Right/Droite/Rechts<br> | Contour Rotor<br>Universal left<br>and right fitment |                     | Sintered/HH Pads/<br>Grooved shoes |                      | Contour Rotor<br>Rear fitment |
| YZ 400 D/E/F                    | 77-79      | Y507             | Y507G                              |                       |                         |  | Y511                | Y511G                              |                      |                               |
| YZ 400 FK                       | 98         | FA185TT          | FA185R■                            | MD6028D✕              |                         | MD6028C  | FA152/2TT           | FA152/2R■                          | MD6011D              |                               |
| YZ 400 FL                       | 99         | FA185TT          | FA185R■                            | MD6028D✕              |                         | MD6028C  | FA131TT             | FA131R■                            | MD6135D              | MD6135C                       |
| WR 400 FK                       | 98         | FA185TT          | FA185R■                            | MD6028D✕              |                         | MD6028C  | FA152/2TT           | FA152/2R■                          | MD6011D              |                               |
| WR 400 FL/FM                    | 99-00      | FA185TT          | FA185R■                            | MD6028D✕              |                         | MD6028C  | FA131TT             | FA131R■                            | MD6135D              | MD6135C                       |
| WR 400 FN                       | 01         | FA185TT          | FA185R■                            | MD6017D✕              |                         | MD6017C  | FA131TT             | FA131R■                            | MD6135D              | MD6135C                       |
| IT 425 G                        | 80         | Y507             | Y507G                              |                       |                         |  | Y511                | Y511G                              |                      |                               |
| WR 426 FN                       | 01         | FA185TT          | FA185R■                            | MD6017D✕              |                         | MD6017C  | FA131TT             | FA131R■                            | MD6135D              | MD6135C                       |
| WR 426 FP                       | 02         | FA185TT          | FA185R■                            | MD6017D✕              |                         | MD6017C  | FA131TT             | FA131R■                            | MD6190D              | MD6190C                       |
| YZ 426 FM                       | 00         | FA185TT          | FA185R■                            | MD6028D✕              |                         | MD6028C  | FA131TT             | FA131R■                            | MD6135D              | MD6135C                       |
| YZ 426 FN                       | 01         | FA185TT          | FA185R■                            | MD6017D✕              |                         | MD6017C  | FA131TT             | FA131R■                            | MD6135D              | MD6135C                       |
| YZ 426 FP                       | 02         | FA185TT          | FA185R■                            | MD6017D✕              |                         | MD6017C  | FA131TT             | FA131R■                            | MD6190D              | MD6190C                       |
| WR 450 FR/FS                    | 03-04      | FA185TT          | FA185R■                            | MD6017D✕              |                         | MD6017C  | FA367TT             | FA367R■                            | MD6190D              | MD6190C                       |
| WR 450 FT/FV                    | 05-06      | FA185TT          | FA185R■                            | MD6017D✕              |                         | MD6017C  | FA367TT             | FA367R■                            | MD6190D              | MD6190C                       |
| Supermoto version               |            |                  |                                    |                       |                         | SM6528   |                     |                                    |                      |                               |
| WR 450 FW                       | 07         | FA185TT          | FA185R■                            |                       |                         | MD6017C<br>SM6528                                    | FA367TT             | FA367R■                            |                      | MD6190C                       |
| Supermoto version               |            |                  |                                    |                       |                         |  |                     |                                    |                      |                               |
| YFM 450 FAR/FAS Kodiak (5ND3/4) | 03-04      | FA54TT*          | FA54R*■                            | MD6215D               | MD6215D                 |  | FA307TT             | FA307R                             | MD6174D              |                               |
| YFM 450 FAT/FAHT/FAV (Kodiak)   | 05-06      | FA54TT*          | FA54R*■                            | MD6215D               | MD6215D                 |  | FA307TT             | FA307R                             | MD6252D              |                               |
| YFM 450 FXV Wolverine           | Left 06    | FA135TT          | FA135R■                            | MD6215D               |                         |  | FA307TT             | FA307R                             | MD6174D              |                               |
|                                 | Right      | FA165TT          | FA165R■                            |                       | MD6215D                 |  |                     |                                    |                      |                               |
| YFM 450 FW Grizzly              | 07         | FA54TT*          | FA54R*■                            | MD6251D               | MD6251D                 |  | FA307TT             | FA307R                             | MD6252D              |                               |
| YFZ 450 S/T                     | Left 04-05 | FA135TT          | FA135R■                            | MD6054D               |                         |  | FA84TT              | FA84R                              | MD6236D              |                               |
|                                 | Right      | FA165TT          | FA165R■                            |                       | MD6054D                 |  |                     |                                    |                      |                               |
| YFZ 450 V/W                     | Left 06-07 | FA135TT          | FA135R■                            | MD6054D               |                         |  | FA323TT             | FA323R                             | MD6263D              |                               |
|                                 | Right      | FA165TT          | FA165R■                            |                       | MD6054D                 |  |                     |                                    |                      |                               |
| YZ 450 FR/FS                    | 03-04      | FA185TT          | FA185R■                            | MD6017D✕              |                         | MD6017C  | FA367TT             | FA367R■                            | MD6190D              | MD6190C                       |
| YZ 450 FT/FV                    | 05-06      | FA185TT          | FA185R■                            | MD6017D✕              |                         | MD6017C  | FA367TT             | FA367R■                            | MD6190D              | MD6190C                       |
| Supermoto version               |            |                  | SM6528                             |                       |                         |  |                     |                                    |                      |                               |
| YZ 450 FW                       | 07         | FA185TT          | FA185R■                            |                       |                         | MD6017C<br>SM6528                                    | FA368TT             | FA368R■                            |                      | MD6190C                       |
| Supermoto version               |            |                  |                                    |                       |                         |  |                     |                                    |                      |                               |
| IT 465 H/J                      | 81-82      | Y508             | Y508G                              |                       |                         |  | Y510                | Y510G                              |                      |                               |
| YZ 465 G                        | 80         | Y508             | Y508G                              |                       |                         |  | Y511                | Y511G                              |                      |                               |
| YZ 465 H                        | 81         | Y508             | Y508G                              |                       |                         |  | Y510                | Y510G                              |                      |                               |
| IT 490 L                        | 84         | Y508             | Y508G                              |                       |                         |  | Y510                | Y510G                              |                      |                               |
| YZ 490 H/J                      | 81-82      | Y508             | Y508G                              |                       |                         |  | Y510                | Y510G                              |                      |                               |
| YZ 490 K                        | 83         | Y508             | Y508G                              |                       |                         |  | Y506                | Y506G                              |                      |                               |
| YZ 490 L                        | 84         | Y508             | Y508G                              |                       |                         |  | Y510                | Y510G                              |                      |                               |
| YZ 490 N/S/T                    | 85-87      | FA105TT          | FA105R                             | MD6067D               |                         |  | Y510                | Y510G                              |                      |                               |
| YZ 490 U                        | 88         | FA105TT          | FA105R                             | MD6039D               |                         |  | Y510                | Y510G                              |                      |                               |
| IT 500 G/H                      | 80-81      | Y507             | Y507G                              |                       |                         |  | Y511                | Y511G                              |                      |                               |
| RD 500 LC                       | 84-86      | FA88*            | FA88HH*                            | MD2069LS              | MD2069RS                |  | FA104               | FA104HH                            | MD2070               |                               |
| SR 500                          | 78-82      | FA34             |                                    | MD2023LS              |                         |  | Y510                |                                    |                      |                               |
| SR 500 (3GW1/3/4/6/7)           | 96-98      | Y526             |                                    |                       |                         |  | Y510                |                                    |                      |                               |
| SR 500 S (3GW5)                 | 98         | Y526             |                                    |                       |                         |  | Y510                |                                    |                      |                               |
| TX/XS 500 B                     | 75-77      | FA11             |                                    |                       | N/A                     |  | Y512                |                                    |                      |                               |
| XP 500 N/P/R T-Max              | 01-03      | FA179            | FA179HH                            | MD2087LS              |                         |  | FA319               | FA319HH                            | MD2011LS             |                               |
| XP 500 S/T/V T-Max (5VU1/2)     | 04-07      | FA199*           | FA199HH*                           | MD2098LS              | MD2098RS                |  | FA408               |                                    | MD2011LS             |                               |
| XS 500 C/D                      | 78-79      | FA34             |                                    |                       | MD2024RS                |  | FA34                |                                    | MD2025               |                               |
| WR 500 ZD                       | 92         | FA135TT          | FA135R■                            | MD6016D               |                         |  | FA152TT             | FA152R■                            | MD6011D              |                               |
| XT 500                          | 76-80      | Y511             | Y511G                              |                       |                         |  | Y510                | Y510G                              |                      |                               |
| XV 535 "Virago"                 | 88-94      | FA136            |                                    |                       | MD2023RS                |  | Y515                |                                    |                      |                               |
| XV 535/535 S "Virago"           | 95-03      | FA179            | FA179HH                            |                       | MD2076RS                |  | Y515                |                                    |                      |                               |
| XJ 550                          | 81-84      | FA70*            |                                    | MD2019LS              | MD2019RS                |  | Y512                |                                    |                      |                               |
| XJ 550 H/J/K "Maxim"            | 81-83      | FA70             |                                    |                       | MD2023RS                |  | Y512                |                                    |                      |                               |
| XJ 550 RH/RJ/RK "Seca"          | 81-83      | FA70             |                                    |                       | MD2023RS                |  | Y516                |                                    |                      |                               |
| XT 550                          | 82-83      | Y510             | Y510G                              |                       |                         |  | Y510                | Y510G                              |                      |                               |
| XZ 550                          | 82-84      | FA81*            |                                    | MD2011LS              | MD2011RS                |  | Y512                |                                    |                      |                               |
| FZ 600                          | 87-88      | FA88*            | FA88HH*                            | MD2011LS              | MD2011RS                |  | FA104               | FA104HH                            | MD2002               |                               |
| FZR 600                         | 89         | FA88*            | FA88HH*                            | MD2001LS              | MD2001RS                | MD2001C*   | FA88                | FA88HH                             | MD2002               | MD2002C                       |

\*-2 Sets Required. ■ - Also available in MX-S race compound, see page 8. ✕ - Oversize and Supermoto disc available - see page 301.

**SAFETY WARNING-** DO NOT USE HH PADS ON REAR UNLESS ALSO USED ON FRONT TO AVOID BRAKE IMBALANCE.

**R** Suffix = High Durability Sintered Pad. **HH** Suffix = High Performance Sintered Pad. **G** Suffix = Grooved Shoe.  
**D** Suffix = Drilled Disc. **C** Suffix = Contoured Disc. **LS** Suffix = Left/Steel Disc. **RS** = Right/Steel Disc.

BRAKE  
APPLICATIONS

# JAPANESE Built Motorcycles

APPLICATIONS

BRAKE



| Front/Avant/Vorn                   |                   | Frente/Anteriore    |  |  | Rear/Arrière/Hinten           |   | Posterior/Posteriore |   |
|------------------------------------|-------------------|---------------------|--|--|-------------------------------|---|----------------------|---|
| 1                                  | 2                 | 3                   | 4  | 5                                      | 6                             | 7 | 8                    | 9 |
| Sintered/HH Pads/<br>Grooved shoes | Left/Gauche/Links | Right/Droite/Rechts | Contour Rotor<br>Universal left<br>and right fitment | Sintered/<br>HH Pads/<br>Grooved shoes | Contour Rotor<br>Rear fitment |   |                      |   |

**YAMAHA** contd.

|  |       |         |           |          |          |          |           |           |         |         |
|--|-------|---------|-----------|----------|----------|----------|-----------|-----------|---------|---------|
| FZR 600                                    | 90-93 | FA160*  | FA160HH*  | MD2001LS | MD2001RS | MD2001C* | FA88      | FA88HH    | MD2002  | MD2002C |
| FZR 600 R                                  | 94-95 | FA160*  | FA160HH*  | MD2001LS | MD2001RS | MD2001C* | FA88      | FA88HH    | MD2002  | MD2002C |
| FZS 600 "Fazer"                            | 98-03 | FA252*  | FA252HH*  | MD2001LS | MD2001RS | MD2001C* | FA104     | FA104HH   | MD2002  | MD2002C |
| FZ6 ABS Fazer (2 piston caliper)           | 04-07 | FA199*  | FA199HH*  | MD2082LS | MD2082RS | MD2082C* | FA174     | FA174HH   | MD2093  | MD2093C |
| FZ6 ABS (Naked Version) (2 piston caliper) | 04-07 | FA199*  | FA199HH*  | MD2082LS | MD2082RS | MD2082C* | FA174     | FA174HH   | MD2093  | MD2093C |
| FZ6 S2 ABS (Naked)                         | 07    | FA252*  | FA252HH*  | MD2082LS | MD2082RS | MD2082C* | FA174     | FA174HH   | MD2093  | MD2093C |
| FZ6 Fazer S2 (ABS) (4 piston caliper)      | 07    |         | FA380HH*  | MD2082LS | MD2082RS | MD2082C* | FA174     | FA174HH   | MD2093  | MD2093C |
| SRX 600 (1JK)                              | 85    | FA104*  | FA104HH*  | MD2011LS | MD2011RS |          | FA104     | FA104HH   | MD2002  | MD2002C |
| SRX 600 (3SX)                              | 90    | FA123   | FA123HH   |          | MD2003RS | MD2003C  | FA104     | FA104HH   | MD2002  | MD2002C |
| SRX 600                                    | 86-87 | FA104*  | FA104HH*  | MD2011LS | MD2011RS |          | FA104     | FA104HH   | MD2002  | MD2002C |
| TT 600 L                                   | 84    | Y508    | Y508G     |          |          |          | Y506      | Y506G     |         |         |
| TT 600 W (59X2JT/3SW1)                     | 89-92 | FA105TT | FA105R■   | MD6039D  |          |          | Y527      | Y527G     |         |         |
| TT 600 E (4LW3/4LW4/4GV4/4GV5)             | 94-01 | FA181TT | FA181R■   | MD6182D  |          |          | FA208TT   | FA208R■   | MD6183D |         |
| TT 600 E (4GV2)                            | 94-95 | FA181TT | FA181R■   | MD6182D  |          |          | FA152/2TT | FA152/2R■ | MD6183D |         |
| TT 600 K (4LW1/4GV1/4LW2)                  |       |         |           |          |          |          |           |           |         |         |
| Up to 4GV 003403 (Nissan rear caliper)     | 93-95 | FA181TT | FA181R■   | MD6182D  |          |          | FA152/2TT | FA152/2R■ | MD6183D |         |
| TT 600 K From 4GV 003404                   |       |         |           |          |          |          |           |           |         |         |
| (Brebro rear caliper)                      | 95-96 | FA181TT | FA181R■   | MD6182D  |          |          | FA208TT   | FA208R■   | MD6183D |         |
| TT 600 R (5CH1)                            | 97    | FA181TT | FA181R■   | MD6182D  |          |          | FA208TT   | FA208R■   | MD6183D |         |
| TT 600 R (5CH2)                            | 98-99 | FA181TT | FA181R■   | MD6182D  |          |          | FA208TT   | FA208R■   | MD6183D |         |
| TT 600 R (5CH3)                            | 00-02 | FA181TT | FA181R■   | MD6182D  |          |          | FA208TT   | FA208R■   | MD6183D |         |
| TT 600 RE (5CH5)                           | 04    | FA181TT | FA181R■   | MD6182D  |          |          | FA208TT   | FA208R■   | MD6183D |         |
| XJ 600                                     | 84-91 | FA88*   | FA88HH*   | MD2011LS | MD2011RS |          | FA88      | FA88HH    | MD2011  |         |
| XJ 600 S "Diversion"                       | 92-97 | FA179   | FA179HH   | MD2031LS |          |          | FA104     | FA104HH   | MD2002  | MD2002C |
| XJ 600 S "Diversion"                       | 98-03 | FA199*  | FA199HH*  | MD2074LS | MD2074RS | MD2074C* | FA104     | FA104HH   | MD2002  | MD2002C |
| XJ 600 N                                   | 95-97 | FA179   | FA179HH   | MD2031LS |          |          | FA104     | FA104HH   | MD2002  | MD2002C |
| XJ 600 N                                   | 98-03 | FA199*  | FA199HH*  | MD2074LS | MD2074RS | MD2074C* | FA104     | FA104HH   | MD2002  | MD2002C |
| XT 600                                     | 84-86 | FA81    | FA81R     | MD6070D  |          |          | Y510      | Y510G     |         |         |
| XT 600                                     | 87    | FA118   |           | MD6070D  |          |          | FA101TT   | FA101R    | MD6072D |         |
| XT 600 Z "Tenere"                          | 84    | FA81    | FA81R     | MD6070D  |          |          | Y510      | Y510G     |         |         |
| XT 600 Z "Tenere"                          | 85-88 | FA118   |           | MD6070D  |          |          | Y510      | Y510G     |         |         |
| XT 600/600 Z "Tenere"                      | 88-90 | FA118   |           | MD6070D  |          |          | FA101TT   | FA101R    | MD6072D |         |
| XT 600 E                                   | 92-94 | FA172TT | FA172R    | MD6070D  |          |          | FA101TT   | FA101R    | MD6072D |         |
| XT 600 E                                   | 95-03 | FA172TT | FA172R    | MD6116D  |          |          | FA101TT   | FA101R    | MD6072D |         |
| Supermoto version                          |       |         |           | SM6116   |          |          |           |           |         |         |
| YFM 600 FWAK/FWAL/FWAM/FWAN "Grizzly"      | 98-01 | FA84TT* | FA84R*    | MD6140D  | MD6140D  |          | Y516      | Y516G     |         |         |
| YFM 600 HM "Grizzly Hunting"               | 00    | FA84TT* | FA84R*    | MD6140D  | MD6140D  |          | Y516      | Y516G     |         |         |
| YF 600 S/SC/TTC/UC/U/W/WC/AIAC "Radian"    | 86-90 | FA88*   | FA88HH*   | MD2011LS | MD2011RS |          | Y512      |           |         |         |
| YZF 600 R "Thunder cat"                    | 96-03 | FA252*  | FA252HH*  | MD2074LS | MD2074RS | MD2074C* | FA88      | FA88HH    | MD2002  | MD2002C |
| YZF-R6                                     | 99-02 | FA252*  | FA252HH*  | MD2074LS | MD2074RS | MD2074C* | FA275     | FA275HH   | MD2084  | MD2084C |
| YZF R6                                     | 03-04 | FA252*  | FA252HH*  | MD2082LS | MD2082RS | MD2082C* | FA174     | FA174HH   | MD2091  | MD2091C |
| YZF R6                                     | 05-07 | >       | FA380HH*  | MD2095LS | MD2095RS | MD2095C* | FA174     | FA174HH   | MD2091  | MD2091C |
| YZF R6S                                    | 07    |         | FA380HH*  | MD2095LS | MD2095RS | MD2095C* | FA174     | FA174HH   | MD2091  | MD2091C |
| XJ 650 G/H/J/K "Maxim"                     | 80-83 | FA61    |           | MD2023LS |          |          | Y512      |           |         |         |
| XJ 650 LH "Midnight"                       | 81    | FA61    |           | MD2023LS |          |          | Y512      |           |         |         |
| XJ 650 RJ "Seca"                           | 82    | FA34*   |           | MD2019LS | MD2019RS |          | Y515      |           |         |         |
| XJ 650 LK "Seca"                           | 83    | FA81*   |           | MD2011LS | MD2011RS |          | Y515      |           |         |         |
| XJ 650                                     | 80-84 | FA34*   |           | MD2019LS | MD2019RS |          | Y515      |           |         |         |
| XJ 650 "Turbo"                             | 82    | FA81*   |           | MD2011LS | MD2011RS |          | Y515      |           |         |         |
| XS 650                                     | 75    | FA11*   |           | N/A      | N/A      |          | Y514      |           |         |         |
| XS 650                                     | 77-81 | FA34*   |           | MD2025LS | MD2025RS |          | Y514      |           |         |         |
| XS 650 SE                                  | 79-80 | FA34    |           |          | MD2024RS |          | FA34      |           | MD2025  |         |
| XS 650 SE                                  | 81    | FA34    |           |          | MD2024RS |          | Y514      |           |         |         |
| XVS 650 "Drag Star"                        | 97-04 | FA179   | FA179HH   |          | MD2076RS |          | Y515      |           |         |         |
| XVS 650 A "Drag Star Classic"              | 98-07 | FA179   | FA179HH   |          | MD2076RS |          | Y515      |           |         |         |
| MT03V (660cc)                              | 06-07 | FA199*  | FA199HH*  | MD2082LS | MD2082RS | MD2082C* | FA213     | FA213HH   | MD2093  | MD2093C |
| SZR 660                                    | 96-97 | FA95    | FA95HH    |          | MD2003RS | MD2003C  | FA47      | FA47HH    | MD2021  |         |
| XT 660 X Supermoto                         | 04-07 | FA244   | FA244HH   | MD6226D  |          |          | FA213     | FA213HH   | MD6234D |         |
| XT 660 R                                   | 04-07 | FA209/2 | FA209/2HH | MD6235D  |          |          | FA213     | FA213HH   | MD6234D |         |
| XTZ 660 "Tenere"                           | 91-98 | FA172TT | FA172R    | MD6116D  |          |          | FA101TT   | FA101R    | MD6072D |         |

\*-2 Sets Required. ■ - Also available in MX-S race compound, see page 8. ✖ - Oversize and Supermoto disc available - see page 301.

**SAFETY WARNING-** DO NOT USE HH PADS ON REAR UNLESS ALSO USED ON FRONT TO AVOID BRAKE IMBALANCE.



# JAPANESE Built Motorcycles



| Front/Avant/Vorn                   |                   | Frente/Anteriore    |  |                                    | Rear/Arrière/Hinten           |   | Posterior/Posteriore |   |
|------------------------------------|-------------------|---------------------|--|------------------------------------|-------------------------------|---|----------------------|---|
| 1                                  | 2                 | 3                   | 4  | 5                                  | 6                             | 7 | 8                    | 9 |
| Sintered/HH Pads/<br>Grooved shoes | Left/Gauche/Links | Right/Droite/Rechts | Contour Rotor<br>Universal left<br>and right fitment | Sintered/HH Pads/<br>Grooved shoes | Contour Rotor<br>Rear fitment |   |                      |   |

YAMAHA contd.

|  |       |          |            |          |          |          |           |           |         |         |
|--|-------|----------|------------|----------|----------|----------|-----------|-----------|---------|---------|
| YFM 660 RN/RP/RR/RS/RT Raptor                    | 01-05 | FA84TT*  | FA84R* ■   | MD6054D  | MD6054D  |          | FA84TT    | FA84R     | MD6237D |         |
| YFM 660 FR/FS/FT Grizzly                         | 03-05 | FA84TT*  | FA84R* ■   | MD6189D  | MD6189D  |          | FA344TT   | FA344R    | MD6197D |         |
| YFM 660 FWAP/FWAR/FWAS/FWAT<br>/FWAV/FGW Grizzly | 02-07 | FA84TT*  | FA84R* ■   | MD6189D  | MD6189D  |          | FA344TT   | FA344R    | MD6197D |         |
| YXR 66 FAS/FAT/FAV Left                          | 04-06 | FA135TT  | FA135R ■   | MD6241D  |          |          | FA428TT   | FA428R    | MD6242D |         |
| Rhino 4x4 Side x Side Right                      |       | FA165TT  | FA165R ■   |          | MD6241D  |          |           |           |         |         |
| FZX 700 SJ/SC/TC "Fazer"                         | 86-87 | FA88*    | FA88HH*    | MD2011LS | MD2011RS |          | FA88      | FA88HH    | MD2069  |         |
| YFM 700 RV/RW Raptor Left                        | 06-07 | FA135TT  | FA135R ■   | MD6054D  |          |          | FA428TT   | FA428R    | MD6263D |         |
| Right  |       | FA165TT  | FA165R ■   |          | MD6054D  |          |           |           |         |         |
| YFM 700 FGPW Grizzly Left                        | 07    | FA443TT  | FA443R     | MD6291D  |          |          | FA445TT   | FA445R    | MD6292D |         |
| Right  |       | FA444TT  | FA444R     |          | MD6291D  |          | FA446TT   | FA446R    | MD6292D |         |
| YXP 700 AS/AT/AV Pro Hauler 700<br>Side x Side   | 04-06 | N/A      |            |          |          |          | 534       | 534G      |         |         |
| FZ 750   | 85-86 | FA88*    | FA88HH*    | MD2069LS | MD2069RS |          | FA88      | FA88HH    | MD2069  |         |
| FZ 750   | 87-88 | FA88     | FA88HH     | MD2011LS | MD2011RS |          | FA88      | FA88HH    | MD2011  |         |
| FZ 750   | 89-91 | FA123*   | FA123HH*   | MD2001LS | MD2001RS | MD2001C* | FA88      | FA88HH    | MD2011  |         |
| FZX 750  | 87    | FA88*    | FA88HH*    | MD2011LS | MD2011RS |          | FA88      | FA88HH    | MD2069  |         |
| FZR 750 "Genesis"                                | 87    | FA123*   | FA123HH*   | MD2003LS | MD2003RS | MD2003C* | FA88      | FA88HH    | MD2011  |         |
| FZR 750 R "OWO1"                                 | 89-90 | FA145*   | FA145HH*   | MD2009LS | MD2009RS |          | FA88      | FA88HH    | MD2008  |         |
| XJ 750 RF/RJ/RK "Seca"                           | 81-83 | FA70*    |            | MD2023LS | MD2023RS |          | Y515      |           |         |         |
| XJ 750   | 82-84 | FA70*    |            | MD2023LS | MD2023RS |          | Y515      |           |         |         |
| XS 750   | 77-79 | FA34*    |            | MD2025LS | MD2025RS |          | FA34      |           | MD2025  |         |
| XS 750 SE Left                                   | 79-80 | FA61     |            | MD2025LS |          |          | FA34      |           | MD2025  |         |
| Right  |       | FA41     |            |          | MD2025RS |          |           |           |         |         |
| XTZ 750 "Super Tenere" Left                      | 89-95 | FA135TT  | FA135R ■   | MD6118D  |          |          | FA165/2TT | FA165/2R  | MD6119D |         |
| Right  |       | FA165TT  | FA165R ■   |          | MD6118D  |          |           |           |         |         |
| XV 750 SE  | 81    | FA61     |            | MD2024LS |          |          | Y512      |           |         |         |
| XV 750 Virago                                    | 92-93 | FA88*    | FA88HH*    | MD2011LS | MD2011RS |          | Y512      |           |         |         |
| XV 750 Virago                                    | 94-97 | FA179*   | FA179HH*   | MD2067LS | MD2067RS |          | Y515      |           |         |         |
| YZF 750 R/SP                                     | 93-97 | FA190*   | FA190HH*   | MD2003LS | MD2003RS | MD2003C* | FA88      | FA88HH    | MD2002  | MD2002C |
| YZF-R7 750 "OWO2" (Race Version)                 | 99-01 | FA424*   | FA424HH*   | MD722LD  | MD722RD  |          | TBA       |           | MD2083  |         |
| YZF-R7 750 "OWO2" (Road Version) (5FL1)          | 99-01 | FA252*   | FA252HH*   | MD2083LS | MD2083RS |          | FA267     | FA267HH   | MD2086  |         |
| TDM 850  | 91-95 | FA123*   | FA123HH*   | MD2001LS | MD2001RS | MD2001C* | FA88      | FA88HH    | MD2002  | MD2002C |
| TDM 850  | 96-01 | FA160*   | FA160HH*   | MD2001LS | MD2001RS | MD2001C* | FA88      | FA88HH    | MD2002  | MD2002C |
| TRX 850  | 96-99 | FA123*   | FA123HH*   | MD2001LS | MD2001RS | MD2001C* | FA88      | FA88HH    | MD2002  | MD2002C |
| XS 850   | 80    | FA34*    |            | MD2024LS | MD2024RS |          | FA34      |           | MD2024  |         |
| TDM 900 P/R/S/T/V                                | 02-06 | FA252*   | FA252HH*   | MD2074LS | MD2074RS | MD2074C* | FA319/2   | FA319/2HH | MD2002  | MD2002C |
| TDM 900 AT/AV/AW (ABS)                           | 05-07 | FA252*   | FA252HH*   | MD2074LS | MD2074RS | MD2074C* | FA319/2   | FA319/2HH | MD2002  | MD2002C |
| XJ 900/900 F                                     | 83-86 | FA88*    | FA88HH*    | MD2069LS | MD2069RS |          | FA88      | FA88HH    | MD2069  |         |
| XJ 900/900 F                                     | 87-94 | FA88*    | FA88HH*    | MD2011LS | MD2011RS |          | FA88      | FA88HH    | MD2069  |         |
| XJ 900 'S' "Diversion"                           | 95-03 | FA179*   | FA179HH*   | MD2012LS | MD2012RS |          | FA88      | FA88HH    | MD2011  |         |
| FZR 1000 "Genesis"                               | 87-88 | FA123*   | FA123HH*   | MD2003LS | MD2003RS | MD2003C* | FA88      | FA88HH    | MD2011  |         |
| FZR 1000 "EX UP"                                 | 89-90 | FA160*   | FA160HH*   | MD2003LS | MD2003RS | MD2003C* | FA88      | FA88HH    | MD2011  |         |
| FZR 1000 "EX UP"                                 | 91-93 | FA182*   | FA182HH*   | MD2003LS | MD2003RS | MD2003C* | FA88      | FA88HH    | MD2011  |         |
| FZR 1000 "EX UP"                                 | 94-95 | FA190*   | FA190HH*   | MD2003LS | MD2003RS | MD2003C* | FA88      | FA88HH    | MD2011  |         |
| FZS 1000 Fazer                                   | 01-05 | FA252*   | FA252HH*   | MD2074LS | MD2074RS | MD2074C* | FA348     | FA348HH   | MD2011  |         |
| FZ1 N/IV (Naked) (2D11/2/3) (1000cc)             | 06-07 |          | FA380HH*   | MD2101LS | MD2101RS |          | FA174     | FA174HH   | MD2093  |         |
| FZ1 Fazer S/FZ-1/SV (3C3)                        | 06-07 |          | FA380HH*   | MD2101LS | MD2101RS |          | FA174     | FA174HH   | MD2093  |         |
| GTS 1000   | 93-99 | FA191    |            | N/A      |          |          | FA88      |           | MD2075  |         |
| XV 1000 "TR1"                                    | 81    | FA34*    |            | MD2019LS | MD2019RS |          | Y515      |           |         |         |
| XV 1000 "Virago"                                 | 86    | FA88*    | FA88HH*    | MD2011LS | MD2011RS |          | Y515      |           |         |         |
| XV 1000 SE "Virago"                              | 88    | FA88*    | FA88HH*    | MD2011LS | MD2011RS |          | Y515      |           |         |         |
| YZF 1000 R "Thunderace"                          | 96-01 | FA252*   | FA252HH*   | MD2074LS | MD2074RS | MD2074C* | FA88      | FA88HH    | MD2002  | MD2002C |
| YZF R1   | 98-01 | FA252*   | FA252HH*   | MD2074LS | MD2074RS | MD2074C* | FA267     | FA267HH   | MD2086  | MD2086C |
| YZF R1   | 02-03 | FA252*   | FA252HH*   | MD2074LS | MD2074RS | MD2074C* | FA275     | FA275HH   | MD2084  | MD2084C |
| YZF R1   | 04-06 | 〉        | FA380HH*   | MD2094LS | MD2094RS | MD2094C* | FA174     | FA174HH   | MD2091  | MD2091C |
| YZF-R1SP   | 06    | 〉        | FA380HH*   | N/A      | N/A      |          | FA174     | FA174HH   | MD2091  | MD2091C |
| YZF R1 (6 piston radial caliper)                 | 07    | FA442/4* | FA442/4HH* | MD2102LS | MD2102RS | MD2102C* | FA174     | FA174HH   | MD2091  | MD2091C |
| YXP 1000 AS/AT Pro Hauler 1000 Side x Side       | 04-05 | Y534*    | Y534G*     |          |          |          | Y534      | Y534G     |         |         |
| BT 1100 P/R/S/T/V Bulldog                        | 02-06 | FA252*   | FA252HH*   | MD2074LS | MD2074RS | MD2074C* | FA88      | FA88HH    | MD2011  |         |

\*-2 Sets Required. ■ - Also available in MX-S race compound, see page 8. ✖ - Oversize and Supermoto disc available - see page 301.

**SAFETY WARNING-** DO NOT USE HH PADS ON REAR UNLESS ALSO USED ON FRONT TO AVOID BRAKE IMBALANCE.

R Suffix = High Durability Sintered Pad. HH Suffix = High Performance Sintered Pad. G Suffix = Grooved Shoe.  
D Suffix = Drilled Disc. C Suffix = Contoured Disc. LS Suffix = Left/Steel Disc. RS = Right/Steel Disc.

BRAKE  
APPLICATIONS

# JAPANESE Built Motorcycles

APPLICATIONS

BRAKE



| YAMAHA contd.  | Year  | Front/Avant/Vorn               |                                | Frente/Anteriore  |                     | Rear/Arrière/Hinten                            |                                | Posterior/Posteriore           |                            |
|--|-------|--------------------------------|--------------------------------|-------------------|---------------------|--|--------------------------------|--------------------------------|----------------------------|
|  |       | 1                              | 2                              | 3                 | 4                   | 5  | 6                              | 7                              | 8                          |
|  |       | Sintered/HH Pads/Grooved shoes | Sintered/HH Pads/Grooved shoes | Left/Gauche/Links | Right/Droite/Rechts | Contour Rotor Universal left and right fitment | Sintered/HH Pads/Grooved shoes | Sintered/HH Pads/Grooved shoes | Contour Rotor Rear fitment |
| FJ 1100  | 84-85 | FA88*                          | FA88HH*                        | MD2068LS          | MD2068RS            |  | FA88                           | FA88HH                         | MD2068                     |
| XS 1100  | 78-80 | FA34*                          |                                | MD2024LS          | MD2024RS            |  | FA34                           |                                | MD2024                     |
| XS 1100 S  | 81    | FA70*                          |                                | MD2024LS          | MD2024RS            |  | FA34                           |                                | MD2024                     |
| XV 1100 "Virago"   | 89-93 | FA88*                          | FA88HH*                        | MD2011LS          | MD2011RS            |  | Y515                           |                                |                            |
| XV 1100 "Virago"   | 94-98 | FA179*                         | FA179HH*                       | MD2067LS          | MD2067RS            |  | Y515                           |                                |                            |
| XV 1100 "Virago"   | 99    | FA199*                         | FA199HH*                       | MD2067LS          | MD2067RS            |  | FA88                           | FA88HH                         | MD2011                     |
| XVS 1100 Drag Star   | 99-04 | FA199*                         | FA199HH*                       | MD2076LS          | MD2076RS            |  | FA88                           | FA88HH                         | MD2092                     |
| XVS 1100 A "Dragstar Classic"  | 00-06 | FA199*                         | FA199HH*                       | MD2076LS          | MD2076RS            |  | FA88                           | FA88HH                         | MD2092                     |
| FJ 1200 (ITX Type)   | 86-87 | FA88*                          | FA88HH*                        | MD2068LS          | MD2068RS            |  | FA88                           | FA88HH                         | MD2068                     |
| FJ 1200 (3CV/3XW Type)   | 88-95 | FA123*                         | FA123HH*                       | MD2001LS          | MD2001RS            | MD2001C*                                       | FA88                           | FA88HH                         | MD2068                     |
| FJ 1200 A (ABS Model)  | 91-95 | FA160*                         | FA160HH*                       | MD2046LS          | MD2046RS            |  | FA88                           | FA88HH                         | MD2068                     |
| XJR 1200   | 95-98 | FA123*                         | FA123HH*                       | MD2003LS          | MD2003RS            | MD2003C*                                       | FA88                           | FA88HH                         | MD2011                     |
| XVZ 12 TD  | 85    | FA88*                          | FA88HH*                        | MD2081LS          | MD2081RS            |  | FA88                           | FA88HH                         | MD2081                     |
| V-Max 12   | 91-92 | FA88*                          | FA88HH*                        | MD2068LS          | MD2068RS            |  | FA88                           | FA88HH                         | MD2068                     |
| V-Max 12   | 93-03 | FA160*                         | FA160HH*                       | MD2074LS          | MD2074RS            | MD2074C*                                       | FA88                           | FA88HH                         | MD2068                     |
| FJR 1300 N/P   | 01-02 | FA252*                         | FA252HH*                       | MD2074LS          | MD2074RS            | MD2074C*                                       | FA319/2                        | FA319/2HH                      | MD2092                     |
| FJR 1300 R/R/S/AS/AT/T (ABS)   | 03-05 | FA252*                         | FA252HH*                       | MD2089LS          | MD2089RS            |  | FA319/2                        | FA319/2HH                      | MD2092                     |
| FJR 1300 AV/ASV (ABS Model) (SP61/2/3)                                 | 06-07 |                                | FA423/4HH*                     | MD2089LS          | MD2089RS            |  | FA319/2                        | FA319/2HH                      | MD2100                     |
| FJR 1300 AS (2D21)   | 06    |                                | FA423/4HH*                     | MD2089LS          | MD2089RS            |  | FA319/2                        | FA319/2HH                      | MD2100                     |
| XJR 1300 L 5EA2/5EA3/5EA4  | 99    | FA252*                         | FA252HH*                       | MD2074LS          | MD2074RS            | MD2074C*                                       | FA88                           | FA88HH                         | MD2011                     |
| XJR 1300 M 5EAA/5EAB/5EAC  | 00    | FA252*                         | FA252HH*                       | MD2074LS          | MD2074RS            | MD2074C*                                       | FA88                           | FA88HH                         | MD2011                     |
| XJR 1300 (5EA1/5EA7) (320mm front discs) (Brembo calipers)             | 98-99 | FA244*                         | FA244HH*                       | MD2003LS          | MD2003RS            | MD2003C*                                       | FA88                           | FA88HH                         | MD2011                     |
| XJR 1300 (5EA9/5EAG) (298mm front disc)                                | 00    | FA252*                         | FA252HH*                       | MD2074LS          | MD2074RS            | MD2074C*                                       | FA267                          | FA267HH                        | MD2011                     |
| XJR 1300 N/P (5EAP/5EAR/5EAS/5EAT/5EAW /5EAV/5EAY) (298mm front discs) | 01-02 | FA252*                         | FA252HH*                       | MD2074LS          | MD2074RS            | MD2074C*                                       | FA348                          | FA348HH                        | MD2011                     |
| XJR 1300 R/S 5WM1/5WM3/5WM5/5WM6/5WM7/5WM9                             | 03-04 | FA252*                         | FA252HH*                       | MD2074LS          | MD2074RS            | MD2074C*                                       | FA348                          | FA348HH                        | MD2011                     |
| XJR 1300 TV/W 5WMA/5WMC/5WMD /5WMF                                     | 05-07 | FA252*                         | FA252HH*                       | MD2074LS          | MD2074RS            | MD2074C*                                       | FA348                          | FA348HH                        | MD2011                     |
| XJR 1300 SP (L) (5EA5/5EA6/5EA8)                                       | 99    | FA252*                         | FA252HH*                       | MD2074LS          | MD2074RS            | MD2074C*                                       | FA88                           | FA88HH                         | MD2011                     |
| XJR 1300 SP (M) (5EAD/5EAE/5EAF)                                       | 00    | FA252*                         | FA252HH*                       | MD2074LS          | MD2074RS            | MD2074C*                                       | FA88                           | FA88HH                         | MD2011                     |
| XJR 1300 SP (N) (5EAL/5EAM/5EAN)                                       | 01    | FA252*                         | FA252HH*                       | MD2074LS          | MD2074RS            | MD2074C*                                       | FA88                           | FA88HH                         | MD2011                     |
| XVS 1300 A Midnight Star   | 07    | FA199*                         | FA199HH*                       | MD2074LS          | MD2074RS            | MD2074C*                                       | FA319/2                        | FA319/2HH                      | MD2103                     |
| XVZ 13 AH/ATH "Royal Star" /Royal Star Tour Classic                    | 96-01 | FA123*                         | FA123HH*                       | MD2076LS          | MD2076RS            |  | FA123                          | FA123HH                        | MD2078                     |
| XVZ 1300 TF "Venture Star"   | 99-01 | FA179*                         | FA179HH*                       | MD2076LS          | MD2076RS            |  | FA123                          | FA123HH                        | MD2078                     |
| XV 1600 A "Wildstar"   | 99-04 | FA179*                         | FA179HH*                       | MD2076LS          | MD2076RS            |  | FA123                          | FA123HH                        | MD2088                     |
| MT-01 (1670cc)   | 05-06 |                                | FA380HH*                       | MD2094LS          | MD2094RS            | MD2094C*                                       | FA196                          | FA196HH                        | MD2011                     |
| MT-01 (6 piston radial caliper)  | 07    |                                | FA442/4HH*                     | MD2094LS          | MD2094RS            | MD2094C*                                       | FA196                          | FA196HH                        | MD2011                     |
| XV 1700 PCR Road Star Warrior  | 03-05 | FA252*                         | FA252HH*                       | MD2074LS          | MD2074RS            | MD2074C*                                       | FA319/2                        | FA319/2HH                      | MD2092                     |
| XV 1900 A Midnight Star  | 06-07 | FA252*                         | FA252HH*                       | MD2074LS          | MD2074RS            | MD2074C*                                       | FA319/2                        | FA319/2HH                      | MD2099                     |

\*-2 Sets Required. ■ - Also available in MX-S race compound, see page 8. ✖ - Oversize and Supermoto disc available - see page 301.

**SAFETY WARNING-** DO NOT USE HH PADS ON REAR UNLESS ALSO USED ON FRONT TO AVOID BRAKE IMBALANCE.

# ROAD RACING APPLICATIONS

| Make & Model            | Year  | FRONT                 |                                 |                  |                   | REAR                  |                             |             |
|-------------------------|-------|-----------------------|---------------------------------|------------------|-------------------|-----------------------|-----------------------------|-------------|
|                         |       | Organic Pads or Shoes | Sintered/ HH Pads Grooved shoes | Brake Rotor Left | Brake Rotor Right | Organic Pads or Shoes | Sintered Pads Grooved shoes | Brake Rotor |
| <b>HONDA</b>            |       |                       |                                 |                  |                   |                       |                             |             |
| RS 125                  | 88-89 | FA124                 | FA124HH                         |                  | MD733RD           | FA151                 |                             | MD713       |
| RS 125                  | 90-94 | FA226                 | GFA226HH                        |                  | MD1003RD          | FA151                 |                             | MD713       |
| RS 125                  | 95-06 | FA239                 | GFA239HH                        |                  | MD1003RD          | FA151                 |                             | MD713       |
| RS 250                  | 88-89 | FA124*                | FA124HH*                        | MD1003LD         | MD1003RD          | FA151                 |                             | MD724       |
| RS 250                  | 90-94 | FA226*                | GFA226HH*                       | MD1003LD         | MD1003RD          | FA151                 |                             | MD724       |
| RS 250                  | 95-06 | FA239*                | GFA239HH*                       | MD1003LD         | MD1003RD          | FA151                 |                             | MD724       |
| <b>YAMAHA</b>           |       |                       |                                 |                  |                   |                       |                             |             |
| TZ 125                  | 94-   | FA145                 | GFA145HH                        |                  | MD711RD           | FA162                 |                             | MD732       |
| TZ 250                  | 89-97 | FA145*                | GFA145HH*                       | MD711LD          | MD711RD           | FA162                 |                             | MD732       |
| TZ 250                  | 98-02 | FA145*                | GFA145HH*                       | MD730LD          | MD730RD           | FA162                 |                             | MD732       |
| TZ 250 (Radial Caliper) | 03-   |                       | GFA347HH*                       | MD730LD          | MD730RD           | FA162                 |                             | MD732       |

## PADS FOR AFTERMARKET CALIPERS

| AP/LOCKHEED (CP= Lockheed Pad Ref)  | ISR Contd.  |
|---|---|
| 2 Piston (CP2195)   | FA16/FA16S/FA16HH 22-032 (6 Piston Large) FA175x3                 |
| 4 Piston (CP4484/3369)  | FA107A (8mm pad) 22-033 (2 Piston HD) FA16                        |
| 4 Piston (CP4485)   | FA107/2A (7mm pad) 22-034 (6 Piston Small) FA184x3                |
| 6 Piston (CP3366/67)  | FA217 22-036 (2 Piston) FA184                                     |
| 6 Piston (CP4466)   | GFA263HH 22-042 (6 Piston Racing) GFA175HHx3                      |
| 2 Piston (CP4226)   | N/A 22-043 (4 Piston) FA184*                                      |
| 4 Piston (CP4484 D27) Radial Mount  | TBA Radial 6 Piston Monoblock FA184x3                             |
| 4 Piston (CP4680)   | N/A <b>JAYBRAKE</b>   |
| CP6688 - 4EOM/5EOM  | N/A 2 Piston caliper (small) FA115/FA115HH                        |
| CP4488 4 Piston Radial 2 Piece  | N/A 2 Piston caliper (larger) FA76                                |
| CP7853 4 Piston Radial Monobloc   | N/A 6 Piston caliper FA243  |
| CP4680 Supermoto  | N/A <b>MAGURA</b>   |
| <b>BEHRINGER</b>  | <b>PART NO</b>  |
| 6 Piston  | FA249 4 Piston Radial Supermoto Caliper FA433/4/FA433/4HH         |
| 6 Piston Old design / 2 piston  | FA47 2 Piston Rear Caliper TBA                                    |
| 6 Piston (Endurance)  | FA249/2 <b>NOVA/LEGENDS</b> FA216/3                               |
| 6 Piston (Supermoto)  | MXS406 <b>PERFORMANCE MACHINE</b>                                 |
| 4 Piston  | FA158 112 X 6B FA249  |
| 4 Piston (Radial)   | MXS405 112 X 6QC FA249  |
| <b>BREMBO</b>   | 112 X 6RSB FA190  |
| 20 5185 11 (P32B) (Single pad fixing pin) (2 piston)                            | FA47 112 X 6SSB FA190   |
| 20 5161 42 (P32F) (Single pad fixing pin) (2 piston)                            | FA47 124 X 4HR FA216/2  |
| 20 6950 51 (P32G) (Single pad fixing pin) (2 piston)                            | FA266 125 X 2   |
| 20 6951 50/45 (P34G) (Single pad fixing pin) (2 piston)                         | FA266 125 X 4R FA216  |
| 20 7850 11/21 (P434A) (Wire clip pad retention) (4 piston)                      | FA322/4HH 125 X 4RSPH FA216                                       |
| 98-88-70 (P2-34) Rear caliper (2 piston)  | N/A 125 X 4S FA115  |
| 20-61-01 (P4-24) Rear caliper (4 piston)  | N/A 125 X 4SL FA115   |
| A3 B8 60/61/30/31 Racing radical caliper 2 piece (Single pin fixing) (4 piston) | GFA218HH 125 X 6  |
| 97 37 60/61 Radial monoblock racing (Single pin pad fixing) (4 piston)          | GFA218/2HH 125 X 6QC FA190  |
| 20 5165 55/65 Goldline 4 piston (Single pin pad fixing)                         | FA95 137 X 4 FA216/2  |
| 20 6800 10/20 (4 piston) (two pin pad fixing)                                   | FA244/FA244HH 137 X 4 (2006) FA420HH                              |
| 20 4756 05/06 Billet (4 piston) (Single pin pad fixing)                         | FA95 137 X 4B FA216   |
| 10.48.13 & 14 GP2 piece 4 piston caliper (Single pin pad fixing)                | GFA218HH 137 X 6 FA210  |
| 10.17.40 / 41 Monobloc 4 piston caliper (Single pad pin fixing)                 | GFA218/2HH 162 X 2 FA32   |
| 20.60.01 (P2-24) Rear caliper (2 piston)  | N/A <b>PFM</b>  |
| 20 8343 35/45/11/21 Radial Mount Goldline (Wire clip pad retention) (P434B)     | FA322/4HH 6 Piston Superbike caliper GFA263HH                     |
| X99.04 Radial Mount Caliper 4 piston/4 pad                                      | GFA435/4HHLC <b>PRE TECH</b>                                      |
| Monobloc M4 Radial Mont (1 pc pad)  | GFA447HH 4 Piston (Uni P401) FA180                                |
| P4 32/36 X 97.37.80/81  | GFA295HH 4 Piston (P402) Lockheed Replacement Caliper FA158       |
| <b>EBC</b>  | 6 Piston (Radial Mount) FA190                                     |
| 4 Piston  | FA216/2 6 Piston (Radial Mount) FA249                             |
| <b>FTE</b>  | <b>PRO-ONE</b>  |
| 4 Piston Radial Supermoto   | MXS405 2 Piston FA47  |
| <b>GMA</b>  | 4 Piston FA158  |
| 2 Piston rear (large) caliper model A   | FA36 (CCI# 09-997) 4 Piston Radial Mount Caliper GFA435/4HH LC    |
| 2 Piston (small) caliper model B  | FA76 (CCI# 09-996) 4 Piston race caliper FA211/2                  |
| 4 Piston model F  | FA115 6 Piston (old large design) GFA183HH                        |
| <b>HARRISON BILLET</b>  | 6 Piston (new small design) GFA276HH                              |
| Light weight 4/6 Piston (1296033)   | CFK175/FA175HH <b>REVTECH / WILWOOD</b>                           |
| Early design 4/6 Piston (1296040)   | CFK47/FA47HH CCI Polished caliper (front/rear) FA95 (CCI# 59-110) |
| <b>IRON PEGASUS</b>   | 6 Piston VR1000 race caliper FA217                                |
| Small caliper   | FA115/FA47HH <b>SPONDON</b>                                       |
| <b>ISR</b>  | 4 Piston Caliper FA107A (8mm)                                     |
| 22-023-0A (2 Piston)  | FA11 22-025-XX (4 Piston) FA107/2A (7mm)                          |
| 22-025-XX (4 Piston)  | FA47* <b>SPIEGLER</b>   |
| 22-026-0A (Sprocket Caliper)  | FA11 4 Piston Caliper S4B N/A                                     |
| 22-027 (2 Piston Rear)  | FA47 8 Piston Caliper S8B N/A                                     |
| 22-028 (2 Piston)   | FA47 <b>THUNDERHEART</b> N/A                                      |
| 22-029 (Rear 2 Piston)  | FA47  |
| 22-030 (2 Piston Rear)  | FA16  |

# US Built Motorcycles



Make / Model / Year  
**HARLEY-DAVIDSON®**

FXST, FXSTB, FXSTC, FXSTS, FLST, FLSTC,  
FLSTF, FLSTS, FLSTN

(Fat boy®, Softail®, Softail Custom®,  
Heritage Softail®, Heritage Softail Custom®,  
Heritage Springer®, Springer®, Night train®)

84-99

84- Early 87 (Girling Caliper)

Late 87-99

FX, FXE, FXEF, FXWG, FXS

73-77 (FX, FXE) (Rivet Type)

Late 78-83 (Twin Fronts)

84-86

84-86

73-83 (Banana Caliper)

83 (FXWG, FXSB)

FL, FLH

49-71

58-62

72-84 (Banana Caliper)

72-80 (Banana Caliper)

81-84

XL, XLH, XLCH, XLS, XLX (Sportster®, 53C Custom®)

54-78

54-72

73-77 (XLH, XLCH) (Rivet Type)

79-83 (Twin Fronts)

79-81

82-Early 87 (Girling Caliper)

84-99

Late 87-99

FXD, FXDL, FXDWG, FXR, FXRS, FXRT, FXRD, FXLR

(Convertible®, Dyna®, Superglide®,

Sportglide®, Lowrider®, Wide Glide®)

82-83 (Twin Fronts)

84-99

82-Early 87 (Girling Caliper)

Late 87-99

FLT, FLHT, FLHTCI

(Ultraglide®, Electraglide®, Electraglide Classic®/Ultra Classic®)

80-83

84-99

80-85

86-99

FLHR, FLHRCI (Road King®, Road King Classic®)

94-99

**SPORTSTER SERIES**

XL 50 50th Anniversary Sporster

07

XLH Sportster 883

00-03

XLH Sportster 883 R "Flat Track"

00-03

XL Sportster 883 Hugger

00-03

XL Sportster 53c Custom (883cc)

00-03

XL 883 Sportster Standard

04-07

XL 883 C Sportster Custom

04-07

XL 883 L "883 Low"

04-07

XL 883 R Sportster R

05-07

XL Sportster 1200c Custom

00-03

XL Sportster 1200s Sport

00-03

XL 1200 R Sportster Roadster

04-07

| Make / Model / Year   | Disc  | EBC #  | Sintered/ HH Pads | Motorcycle |        | Sandwich |         |
|---|-------|--------|-------------------|------------|--------|----------|---------|
|   |       |        |                   | Left       | Right  | Left     | Right   |
| FXST, FXSTB, FXSTC, FXSTS, FLST, FLSTC, FLSTF, FLSTS, FLSTN   |       |        |                   |            |        |          |         |
| (Fat boy®, Softail®, Softail Custom®, Heritage Softail®, Heritage Softail Custom®, Heritage Springer®, Springer®, Night train®) |       |        |                   |            |        |          |         |
| 84-99   | F     | FA94   | FA94HH            | FSD009     |        |          |         |
| 84- Early 87 (Girling Caliper)  | R     | FA78   | FA78HH            |            |        |          |         |
| Late 87-99  | R     | FA200  | FA200HH           |            |        |          | RSD019  |
| FX, FXE, FXEF, FXWG, FXS  |       |        |                   |            |        |          |         |
| 73-77 (FX, FXE) (Rivet Type)  | F     | FA26   |                   |            |        |          |         |
| Late 78-83 (Twin Fronts)  | F     | FA71   |                   |            |        |          |         |
| 84-86   | F     | FA94*  | FA94HH*           | FSD009     | FSD009 |          | N/A     |
| 84-86   | R     | FA78   | FA78HH            |            |        |          |         |
| 73-83 (Banana Caliper)  | R     | FA24/2 |                   |            |        |          |         |
| 83 (FXWG, FXSB)   | R     | FA78   | FA78HH            |            |        |          |         |
| FL, FLH   |       |        |                   |            |        |          |         |
| 49-71   | F     | N/A    |                   |            |        |          |         |
| 58-62   | R     | N/A    |                   |            |        |          |         |
| 72-84 (Banana Caliper)  | F     | FA24/2 |                   | N/A        | N/A    |          |         |
| 72-80 (Banana Caliper)  | R     | FA24/2 |                   |            |        |          |         |
| 81-84   | R     | FA79   |                   |            |        |          | N/A     |
| XL, XLH, XLCH, XLS, XLX (Sportster®, 53C Custom®)   |       |        |                   |            |        |          |         |
| 54-78   | F     | N/A    |                   |            |        |          |         |
| 54-72   | R     | N/A    |                   |            |        |          |         |
| 73-77 (XLH, XLCH) (Rivet Type)  | F     | FA26   |                   | N/A        |        |          |         |
| 79-83 (Twin Fronts)   | F     | FA71   |                   | N/A        |        |          |         |
| 79-81   | R     | FA72   |                   |            |        |          |         |
| 82-Early 87 (Girling Caliper)   | R     | FA78   | FA78HH            |            | N/A    |          |         |
| 84-99   | F     | FA94   | FA94HH            | FSD009     |        |          |         |
| Late 87-99  | R     | FA200  | FA200HH           |            |        |          | RSD019  |
| FXD, FXDL, FXDWG, FXR, FXRS, FXRT, FXRD, FXLR   |       |        |                   |            |        |          |         |
| (Convertible®, Dyna®, Superglide®, Sportglide®, Lowrider®, Wide Glide®)   |       |        |                   |            |        |          |         |
| 82-83 (Twin Fronts)   | F     | FA71   |                   | N/A        |        |          |         |
| 84-99   | F     | FA94*  | FA94HH*           | FSD009     | FSD009 |          |         |
| 82-Early 87 (Girling Caliper)   | R     | FA78   | FA78HH            |            |        |          | N/A     |
| Late 87-99  | R     | FA200  | FA200HH           |            |        |          | RSD019  |
| FLT, FLHT, FLHTCI   |       |        |                   |            |        |          |         |
| (Ultraglide®, Electraglide®, Electraglide Classic®/Ultra Classic®)  |       |        |                   |            |        |          |         |
| 80-83   | F     | FA72   |                   | N/A        |        |          |         |
| 84-99   | F     | FA94*  | FA94HH*           | FSD009     | FSD009 |          |         |
| 80-85   | R     | FA79   |                   |            |        |          | N/A     |
| 86-99   | R     | FA201  | FA201HH           |            |        |          | MD509SR |
| FLHR, FLHRCI (Road King®, Road King Classic®)   |       |        |                   |            |        |          |         |
| 94-99   | F     | FA94*  | FA94HH*           | FSD009     | FSD009 |          |         |
|   | R     | FA201  | FA201HH           |            |        |          | MD509SR |
| <b>SPORTSTER SERIES</b>   |       |        |                   |            |        |          |         |
| XL 50 50th Anniversary Sporster   | 07    | F      | FA381             | FA381HH    | FSD010 |          |         |
|   |       | R      | FA387             | FA387HH    |        |          | RSD010  |
| XLH Sportster 883   | 00-03 | F      | FA400             | FA400HH    | FSD010 |          |         |
|   |       | R      | FA400             | FA400HH    |        |          | RSD020  |
| XLH Sportster 883 R "Flat Track"  | 00-03 | F      | FA400             | FA400HH    | FSD010 |          |         |
|   |       | R      | FA400             | FA400HH    |        |          | RSD020  |
| XL Sportster 883 Hugger   | 00-03 | F      | FA400             | FA400HH    | FSD010 |          |         |
|   |       | R      | FA400             | FA400HH    |        |          | RSD020  |
| XL Sportster 53c Custom (883cc)   | 00-03 | F      | FA400             | FA400HH    | FSD010 |          |         |
|   |       | R      | FA400             | FA400HH    |        |          | RSD020  |
| XL 883 Sportster Standard   | 04-07 | F      | FA381             | FA381HH    | FSD014 |          |         |
|   |       | R      | FA387             | FA387HH    |        |          | RSD016  |
| XL 883 C Sportster Custom   | 04-07 | F      | FA381             | FA381HH    | FSD014 |          |         |
|   |       | R      | FA387             | FA387HH    |        |          | RSD016  |
| XL 883 L "883 Low"  | 04-07 | F      | FA381             | FA381HH    | FSD014 |          |         |
|   |       | R      | FA387             | FA387HH    |        |          | RSD016  |
| XL 883 R Sportster R  | 05-07 | F      | FA381*            | FA381HH*   | FSD014 | FSD012   |         |
|   |       | R      | FA387             | FA387HH    |        |          | RSD016  |
| XL Sportster 1200c Custom   | 00-03 | F      | FA400             | FA400HH    | FSD010 |          |         |
|   |       | R      | FA400             | FA400HH    |        |          | FSD020  |
| XL Sportster 1200s Sport  | 00-03 | F      | FA400*            | FA400HH*   | FSD010 | FSD010   |         |
|   |       | R      | FA400             | FA400HH    |        |          | FSD020  |
| XL 1200 R Sportster Roadster  | 04-07 | F      | FA381*            | FA381HH*   | FSD004 | FSD004   |         |
|   |       | R      | FA387             | FA387HH    |        |          | FSD016  |

\* 2 Sets Required. All names & numbers are for Reference purposes only. ® Registered Trademarks of Harley-Davidson® Motor Corp or Buell.

Recommended Fittings: FA400 for use on polished or chrome show rotors. FA400HH recommended fitting as replacement for O/E.

FA400 will replace FA299 when stock exhausted. FA400 has modified larger pad area to improve braking.

NOTE :- Some models may have a second disc fitted as an optional extra. Please double check with your customer exactly which side the front disc is fitted and if twin disc or single.

For new style discs see pages 10 & 11.

52 Part numbers, illustrations and format of this catalogue are covered by COPYRIGHT. Imitation or copy without our written consent will result in prosecution.

# US Built Motorcycles

| Make / Model / Year<br>HARLEY-DAVIDSON®                | Icon  | Icon | EBC #  | Sintered/<br>HH Pads | Icon    |        | Icon   |       |          |
|--|-------|------|--------|----------------------|---------|--------|--------|-------|----------|
|  |       |      |        |                      | Left    | Right  | Left   | Right |          |
| <b>SPORTSTER SERIES Contd.</b>                         |       |      |        |                      |         |        |        |       |          |
| XL 1200 C Sportster Custom                             | 04-07 | F    | FA381  | FA381HH              | FSD004  |        |        |       |          |
|  |       | R    | FA387  | FA387HH              |         |        | FSD016 |       |          |
| XL 1200 L Sportster Low                                | 07    | F    | FA381  | FA381HH              | FSD010  |        |        |       |          |
|  |       | R    | FA387  | FA387HH              |         |        |        |       | RSD020   |
| <b>DYNA SERIES</b>                                     |       |      |        |                      |         |        |        |       |          |
| FXD Super Glide  | 00-03 | F    | FA400  | FA400HH              | FSD010  |        |        |       |          |
|  |       | R    | FA400  | FA400HH              |         |        |        |       | RSD020   |
| FXDX Super Glide Sport                                 | 00-03 | F    | FA400* | FA400HH*             | FSD010  | FSD010 |        |       |          |
|  |       | R    | FA400  | FA400HH              |         |        |        |       | RSD020   |
| FXDL Low Rider   | 00-03 | F    | FA400* | FA400HH*             | FSD010  | FSD010 |        |       |          |
|  |       | R    | FA400  | FA400HH              |         |        |        |       | RSD020   |
| FXDWG Wide Glide                                       | 00-03 | F    | FA400* | FA400HH*             | FSD010  |        |        |       |          |
|  |       | R    | FA400  | FA400HH              |         |        |        |       | RSD020   |
| FXDS-CON Dyna Convertible                              | 00-02 | F    | FA400* | FA400HH*             | FSD010  | FSD010 |        |       |          |
|  |       | R    | FA400  | FA400HH              |         |        |        |       | RSD020   |
| FXDXT Superglide T-Sport                               | 01-03 | F    | FA400* | FA400HH*             | FSD010  | FSD010 |        |       |          |
|  |       | R    | FA400  | FA400HH              |         |        |        |       | RSD020   |
| FXDi Super Glide 1450                                  | 04-05 | F    | FA400  | FA400HH              | FSD010  |        |        |       |          |
|  |       | R    | FA400  | FA400HH              |         |        |        |       | RSD020   |
| FXDi 35 35th Anniversary Super Glide<br>(Spoke Wheels) | 06    | F    | FA400  | FA400HH              | MD518LS |        |        |       |          |
|  |       | R    | FA400  | FA400HH              |         |        |        |       | RSD020   |
| FXDXi Super Glide Sport                                | 04-05 | F    | FA400* | FA400HH*             | FSD010  | FSD010 |        |       |          |
|  |       | R    | FA400  | FA400HH              |         |        |        |       | RSD020   |
| FXDLi Low Rider 1450                                   | 04-05 | F    | FA400  | FA400HH              | FSD010  |        |        |       |          |
|  |       | R    | FA400  | FA400HH              |         |        |        |       | RSD020   |
| FXDLi Dyna Low Rider<br>(Spoke Wheels)                 | 06    | F    | FA400  | FA400HH              | MD518LS |        |        |       |          |
|  |       | R    | FA400  | FA400HH              |         |        |        |       | RSD020   |
| FXDWGi Wide Glide 1450                                 | 04-05 | F    | FA400  | FA400HH              | FSD010  |        |        |       |          |
|  |       | R    | FA400  | FA400HH              |         |        |        |       | RSD020   |
| FXDWGi Dyna Wide Glide<br>(Spoke Wheels)               | 06-07 | F    | FA400  | FA400HH              | MD518LS |        |        |       |          |
|  |       | R    | FA400  | FA400HH              |         |        |        |       | RSD020   |
| FXDC/FXDCi Super Glide Custom                          | 05    | F    | FA400  | FA400HH              | FSD010  |        |        |       |          |
|  |       | R    | FA400  | FA400HH              |         |        |        |       | RSD020   |
| FXDCi Dyna Superglide Custom<br>(Spoke Wheels)         | 06-07 | F    | FA400  | FA400HH              | MD518LS |        |        |       |          |
|  |       | R    | FA400  | FA400HH              |         |        |        |       | RSD020   |
| FXDBi Street Bob<br>(Spoke Wheels)                     | 06-07 | F    | FA400  | FA400HH              | MD518LS |        |        |       |          |
|  |       | R    | FA400  | FA400HH              |         |        |        |       | RSD020   |
| FXDi Super Glide (Cast wheel)                          | 06-07 | F    | FA400  | FA400HH              | MD516LS |        |        |       |          |
|  |       | R    | FA400  | FA400HH              |         |        |        |       | MD513SKR |
| FXDLi (Cast wheel)                                     | 06-07 | F    | FA400  | FA400HH              | MD516LS |        |        |       |          |
|  |       | R    | FA400  | FA400HH              |         |        |        |       | MD513SKR |
| FXDCi Superglide Custom (Cast wheel)                   | 06    | F    | FA400  | FA400HH              | MD516LS |        |        |       |          |
|  |       | R    | FA400  | FA400HH              |         |        |        |       | MD513SKR |
| FXSTC Softail Custom                                   | 07    | F    | FA400  | FA400HH              | FSD020  |        |        |       |          |
|  |       | R    |        |                      |         |        |        |       | RSD020   |
| <b>SOFTAIL SERIES</b>                                  |       |      |        |                      |         |        |        |       |          |
| FXST/FXSTi Softail Standard                            | 00-05 | F    | FA400  | FA400HH              | FSD010  |        |        |       |          |
|  |       | R    | FA400  | FA400HH              |         |        |        |       | RSD020   |
| FXSTB/FXSTBi Night Train                               | 00-05 | F    | FA400  | FA400HH              | FSD010  |        |        |       |          |
|  |       | R    | FA400  | FA400HH              |         |        |        |       | RSD020   |
| FXSTDi/FXSTDi Softail Deuce/i                          | 00-07 | F    | FA400  | FA400HH              | FSD010  |        |        |       |          |
|  |       | R    | FA400  | FA400HH              |         |        |        |       | RSD020   |
| FXSTS/FXSTSi Softail Springer                          | 00-05 | F    | FA94   | FA94HH               |         | FSD009 |        |       |          |
|  |       | R    | FA400  | FA400HH              |         |        |        |       | RSD020   |
| FLSTF/FLSTFi Fat Boy                                   | 00-07 | F    | FA400  | FA400HH              | FSD010  |        |        |       |          |
|  |       | R    | FA400  | FA400HH              |         |        |        |       | RSD020   |
| FLSTFi Fat Boy 15th Anniversary Edition                | 05    | F    | FA400  | FA400HH              | FSD010  |        |        |       |          |
|  |       | R    | FA400  | FA400HH              |         |        |        |       | RSD020   |
| FLSTCi/FLSTCi Heritage Classic/i                       | 00-07 | F    | FA400  | FA400HH              | FSD010  |        |        |       |          |
|  |       | R    | FA400  | FA400HH              |         |        |        |       | RSD020   |
| FLSTS Heritage Springer                                | 00-03 | F    | FA94   | FA94HH               | FSD009  |        |        |       |          |
|  |       | R    | FA400  | FA400HH              |         |        |        |       | RSD020   |
| FLSTN/FLSTNi Softail Deluxe                            | 05-07 | F    | FA400  | FA400HH              | FSD010  |        |        |       |          |
|  |       | R    | FA400  | FA400HH              |         |        |        |       | RSD020   |
| FLSTSC/FLSTSCi Springer Classic                        | 05-   | F    | FA94   | FA94HH               | FSD009  |        |        |       |          |
|  |       | R    | FA400  | FA400HH              |         |        |        |       | RSD020   |
| FLST/FLSTi Heritage Softail                            | 06    | F    | FA400  | FA400HH              | FSD010  |        |        |       |          |
|  |       | R    | FA400  | FA400HH              |         |        |        |       | RSD020   |
| FXST/FXSTi Softail Standard                            | 06-07 | F    | FA400  | FA400HH              | FSD010  |        |        |       |          |
|  |       | R    | FA434  | FA434HH              |         |        |        |       | RSD020   |

\* 2 Sets Required. All names & numbers are for Reference purposes only. ® Registered Trademarks of Harley-Davidson® Motor Corp or Buell.

Recommended Fittings: FA400 for use on polished or chrome show rotors. FA400HH recommended fitting as replacement for O/E.

FA400 will replace FA299 when stock exhausted. FA400 has modified larger pad area to improve braking.

NOTE :- Some models may have a second disc fitted as an optional extra. Please double check with your customer exactly which side the front disc is fitted and if twin disc or single.

For new style discs see pages 10 & 11.

# US Built Motorcycles



Make / Model / Year  
**HARLEY-DAVIDSON®**



EBC  
#

Sintered/  
HH Pads



Left



Right



Left



Right

| Make / Model / Year  | Disc Brake Icon | Motorcycle/Scooter Icons | EBC #  | Sintered/HH Pads | Left    | Right   | Left  | Right    |
|--|-----------------|--------------------------|--------|------------------|---------|---------|-------|----------|
| <b>SOFTAIL SERIES Contd.</b>   |                 |                          |        |                  |         |         |       |          |
| FXSTB/FXSTBi Night Train Softail 06-07   | F               |                          | FA400  | FA400HH          | FSD010  |         |       |          |
|  | R               |                          | FA434  | FA434HH          |         |         |       | RSD020   |
| FXSTSSE Screaming Eagle Springer Classic 07  | F               |                          | FA94   | FA94HH           |         | TBA     |       |          |
|  | R               |                          | FA434  | FA434HH          |         |         |       | TBA      |
| FLSTSC/FLSTSCi Springer Softail Classic 06-07  | F               |                          | FA94   | FA94HH           | FSD009  |         |       |          |
|  | R               |                          | FA434  | FA434HH          |         |         |       | RSD020   |
| FLSTC heritage Softail Classic 07  | F               |                          | FA400  | FA400HH          | MD512LS |         |       |          |
|  | R               |                          | FA434  | FA434HH          |         |         |       | MD513SKR |
| <b>TOURING SERIES</b>  |                 |                          |        |                  |         |         |       |          |
| FLHRI/FLHR Road King 00-07   | F               |                          | FA400* | FA400HH*         | FSD010  | FSD010  |       |          |
|  | R               |                          | FA400  | FA400HH          |         |         |       | RSD020   |
| FLHRCi Road King Classic 00-07   | F               |                          | FA400* | FA400HH*         | FSD010  | FSD010  |       |          |
|  | R               |                          | FA400  | FA400HH          |         |         |       | RSD020   |
| FLHT/FLHTi Electra Glide Standard 00-07  | F               |                          | FA400* | FA400HH*         | FSD010  | FSD010  |       |          |
|  | R               |                          | FA400  | FA400HH          |         |         |       | RSD020   |
| FLTR/FLTR-i Road Glide 00-07   | F               |                          | FA400* | FA400HH*         | FSD010  | FSD010  |       |          |
|  | R               |                          | FA400  | FA400HH          |         |         |       | RSD020   |
| FLHTCU-i Electra Glide Ultra Classic 00-07   | F               |                          | FA400* | FA400HH*         | FSD010  | FSD010  |       |          |
|  | R               |                          | FA400  | FA400HH          |         |         |       | RSD020   |
| FLHRS/FLHRSi Road King Custom 04-07  | F               |                          | FA400* | FA400HH*         | FSD010  | FSD010  |       |          |
|  | R               |                          | FA400  | FA400HH          |         |         |       | RSD020   |
| FLHTC/FLHTCi Electra Glide Classic 04-07   | F               |                          | FA400* | FA400HH*         | FSD010  | FSD010  |       |          |
|  | R               |                          | FA400  | FA400HH          |         |         |       | RSD020   |
| FLHX/FLHXi Street Glide 06-07  | F               |                          | FA400  | FA400HH          | FSD010  | FSD010  |       |          |
|  | R               |                          | FA400  | FA400HH          |         |         |       | RSD020   |
| FLHRSE Screaming Eagle Road King 07  | F               |                          | FA400  | FA400HH          | TBA     | TBA     |       |          |
|  | R               |                          | FA400  | FA400HH          |         |         |       | TBA      |
| <b>VRSCA/VRSCB</b>   |                 |                          |        |                  |         |         |       |          |
| V-Rod 02-04  | F               |                          | FA400* | FA400HH*         | MD514LS | MD514RS |       |          |
|  | R               |                          | FA400  | FA400HH          |         |         |       | MD515    |
| V-Rod 05-06  | F               |                          | FA409* | FA409HH*         | MD516LS | MD516RS |       |          |
|  | R               |                          | FA409  | FA409HH          |         |         |       | MD517    |
| VRSCAW VRod 07   | F               |                          | FA409* | FA409HH*         | MD516LS | MD516RS |       |          |
|  | R               |                          | FA409  | FA409HH          |         |         |       | MD517    |
| VRSCR Street Rod 05-07   | F               |                          | FA409* | FA409HH*         | MD516LS | MD516RS |       |          |
|  | R               |                          | FA409  | FA409HH          |         |         |       | MD517    |
| VRSCD Night Rod 05-07  | F               |                          | FA409* | FA409HH*         | MD516LS | MD516RS |       |          |
|  | R               |                          | FA409  | FA409HH          |         |         |       | MD517    |
| VRSCDX Night Rod Special 07  | F               |                          | FA409* | FA409HH*         | MD516LS | MD516RS |       |          |
|  | R               |                          | FA409  | FA409HH          |         |         |       | MD517    |
| VRSCX V Rod 07   | F               |                          | FA409* | FA409HH*         | MD519LS | MD519RS |       |          |
|  | R               |                          | FA409  | FA409HH          |         |         |       | MD517    |
| (M2 Cyclone®, S1 Lightning®, S2 Thunderbolt®, S3 Thunderbolt®) 94-97   | F               |                          | FA210  |                  |         | MD719RS |       |          |
|  | R               |                          | FA251  |                  |         |         | MD511 |          |
| (M2 Cyclone®, S1 Lightning®, S1 Whitelightning®, S3 Thunderbolt®, S3T Thunderbolt®, X1 Lightning) (Countersunk screws fixing disc) 98-99 | F               |                          | FA424  | FA424HH          |         | MD719RS |       |          |
|  | R               |                          | FA140  | FA140HH          |         |         | MD511 |          |
| M2 Cyclone, X1 Lightning (Counterbored screws fixing disc) 00-05   | F               |                          | FA424  | FA424HH          |         | MD734RS |       |          |
|  | R               |                          | FA140  | FA140HH          |         |         | MD511 |          |
| Blast 00-07  | F               |                          | FA196  | FA196HH          |         | N/A     |       |          |
|  | R               |                          | FA140  | FA140HH          |         |         |       | N/A      |
| Firebolt XB9R 02-07  | F               |                          | FA140  | FA345HH          |         | N/A     |       |          |
|  | R               |                          | FA140  | FA140HH          |         |         | N/A   |          |
| XB9S Lightning 03-04   | F               |                          | FA140  | FA345HH          |         | N/A     |       |          |
|  | R               |                          | FA140  | FA140HH          |         |         | N/A   |          |
| XB9SX Lightning CityX 05-07  | F               |                          | FA140  | FA345HH          |         | N/A     |       |          |
|  | R               |                          | FA140  | FA140HH          |         |         | N/A   |          |
| XB 12 S Lightning 04-07  | F               |                          | FA140  | FA345HH          |         | N/A     |       |          |
|  | R               |                          | FA140  | FA140HH          |         |         | N/A   |          |
| XB 12 R Firebolt 04-07   | F               |                          | FA140  | FA345HH          |         | N/A     |       |          |
|  | R               |                          | FA140  | FA140HH          |         |         | N/A   |          |
| XB 12 X Ulysses 06-07  | F               |                          | FA140  | FA345HH          |         | N/A     |       |          |
|  | R               |                          | FA140  | FA140HH          |         |         | N/A   |          |
| XB 12 SCG Lightning 06-07  | F               |                          | FA140  | FA345HH          |         | N/A     |       |          |
|  | R               |                          | FA140  | FA140HH          |         |         | N/A   |          |
| XB 12 SS Lightning Long 06-07  | F               |                          | FA140  | FA345HH          |         | N/A     |       |          |
|  | R               |                          | FA140  | FA140HH          |         |         | N/A   |          |

\* 2 Sets Required. All names & numbers are for Reference purposes only. ® Registered Trademarks of Harley-Davidson® Motor Corp or Buell.

Recommended Fittings: FA400 for use on polished or chrome show rotors. FA400HH recommended fitting as replacement for O/E.

FA400 will replace FA299 when stock exhausted. FA400 has modified larger pad area to improve braking.

NOTE :- Some models may have a second disc fitted as an optional extra. Please double check with your customer exactly which side the front disc is fitted and if twin disc or single.

For new style discs see pages 10 & 11.

54 Part numbers, illustrations and format of this catalogue are covered by COPYRIGHT. Imitation or copy without our written consent will result in prosecution.

# US Built Motorcycles

| Make / Model / Year   | Icon  | Disc Icon | EBC #   | Sintered/ HH Pads | Motorcycle Icon |         | Motorcycle Icon |       |
|---|-------|-----------|---------|-------------------|-----------------|---------|-----------------|-------|
|   |       |           |         |                   | Left            | Right   | Left            | Right |
| <b>VICTORY</b>  |       |           |         |                   |                 |         |                 |       |
| Victory "V92C" (All models single front rotor)                | 98-03 | F         | FA244   | FA244HH           | MD727LS         |         |                 |       |
|   |       | R         | FA209/2 | FA209/2HH         |                 |         | MD727           |       |
| Victory V92SC   | 00-03 | F         | FA244*  | FA244HH*          | MD727LS         | MD727RS |                 |       |
|   |       | R         | FA209/2 | FA209/2HH         |                 |         | MD727           |       |
| Victory Vegas   | 03-07 | F         | FA244   | FA244HH           | MD678LS         |         |                 |       |
|   |       | R         | FA209/2 | FA209/2HH         |                 |         | MD678           |       |
| Victory King Pin  | 04-07 | F         | FA244   | FA244HH           | MD678LS         |         |                 |       |
|   |       | R         | FA209/2 | FA209/2HH         |                 |         | MD678           |       |
| Victory Touring Cruiser                                       | 04-07 | F         | FA244*  | FA244HH*          | TBA             | TBA     |                 |       |
|   |       | R         | FA209/2 | FA209/2HH         |                 |         | MD727           |       |
| Hammer  | 05-07 | F         | FA244*  | FA244HH*          | MD678LS         | MD678RS |                 |       |
|   |       | R         | FA209/2 | FA209/2HH         |                 |         | MD678           |       |
| Vegas - 8 Ball  | 05-07 | F         | FA244   | FA244HH           | MD678LS         |         |                 |       |
|   |       | R         | FA209/2 | FA209/2HH         |                 |         | MD678           |       |
| Ness Signature Series   | 05-07 | F         | FA244   | FA244HH           | MD678LS         |         |                 |       |
|   |       | R         | FA209/2 | FA209/2HH         |                 |         | MD678           |       |
| Vegas Jackpot   | 06-07 | F         | FA244   | FA244HH           | MD678LS         |         |                 |       |
|   |       | R         | FA209/2 | FA209/2HH         |                 |         | MD678           |       |
| Hammer S  | 07    | F         | FA244*  | FA244HH*          | MD678LS         | MD678RS |                 |       |
|   |       | R         | FA209/2 | FA209/2HH         |                 |         | MD678           |       |
| <b>INDIAN</b>   |       |           |         |                   |                 |         |                 |       |
| Chief All models Chief/Deluxe/Springfield/Road Master/Vintage | 03-04 | F         | FA216/3 | FA216/3HH         | N/A             |         |                 |       |
|   |       | R         | FA216/3 | FA216/3HH         |                 |         | N/A             |       |
| Spirit All models Deluxe/Springfield/Roadblaster              | 03-04 | F         | FA216/3 | FA216/3HH         | N/A             |         |                 |       |
|   |       | R         | FA216/3 | FA216/3HH         |                 |         | N/A             |       |
| Scout All models Scout/Deluxe/Springfield                     | 03-04 | F         | FA216/3 | FA216/3HH         | N/A             |         |                 |       |
|   |       | R         | FA216/3 | FA216/3HH         |                 |         | N/A             |       |

\* 2 Sets Required. All names & numbers are for Reference purposes only. © Registered Trademarks of Harley-Davidson® Motor Corp or Buell.

Recommended Fittings: FA400 for use on polished or chrome show rotors. FA400HH recommended fitting as replacement for O/E.

FA400 will replace FA299 when stock exhausted. FA400 has modified larger pad area to improve braking.

NOTE :- Some models may have a second disc fitted as an optional extra. Please double check with your customer exactly which side the front disc is fitted and if twin disc or single. For new style discs see pages 10 & 11.

## EBC ORGANIC PADS

Organic pads are suitable for all rotor qualities but especially we received on polished or chromed rotors being less prone to cause rotor damage. The fingertip /instant brake response is quickly appreciated.

## EBC SINTERED HH PADS

Sintered pads give stronger brake effect and are ideal for heat treated stainless/original discs.

## EBC FLOATING ROTORS

Again, 100% British made with polished chrome hubs and unique low carbon rotors for improved stopping power. Rotors come in standard 11½" size which bolt on without mods and utilise standard HD calipers.

Advantages of floating rotors are - better braking, no rotor distortion, reduced chance of rotor cracking, improved brake alignment, stylish looks.

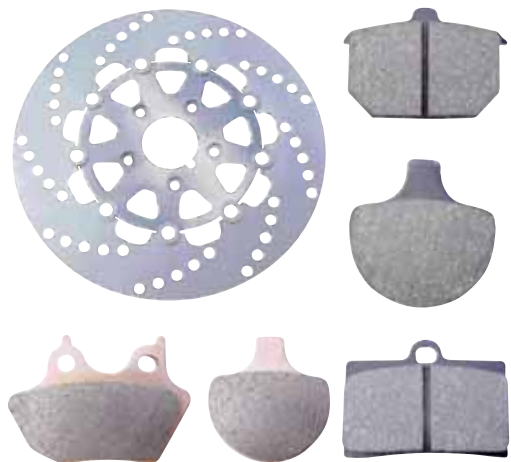

# US Built Motorcycles/Quads



## ARCTIC CAT

|                                      |       | Front/Avant/Vorn |                                    |                   | Frente/Anteriore    |  | Rear/Arrière/Hinten |                                    |         | Posterior/Posteriore          |  |
|--------------------------------------|-------|------------------|------------------------------------|-------------------|---------------------|--|---------------------|------------------------------------|---------|-------------------------------|--|
|                                      |       | 1                | 2                                  | 3                 | 4                   | 5  | 6                   | 7                                  | 8       | 9                             |  |
|                                      |       |                  | Sintered/HH Pads/<br>Grooved shoes | Left/Gauche/Links | Right/Droite/Rechts | Contour Rotor<br>Universal left and<br>right fitment |                     | Sintered/HH Pads/<br>Grooved shoes |         | Contour Rotor<br>Rear fitment |  |
| 50 Y-6 Youths (2x4)                  | 04-06 | H338*            | H338G*                             |                   |                     |  | H307                | H307G                              |         |                               |  |
| DVX 50 (Y6)                          | 06    | H338*            | H338G*                             |                   |                     |  | FA197               |                                    | MD6267D |                               |  |
| 90 Y-12 Youths (2T & 4T Models)      | 02-06 | H338*            | H338G*                             |                   |                     |  | H307                | H307G                              |         |                               |  |
| DVX 90 (Y12 4 stroke)                | 06    | H338*            | H338G*                             |                   |                     |  | FA197               |                                    | MD6267D |                               |  |
| 250 (4x4)                            | 02-04 | FA271TT*         | FA271R*                            | MD6173D           | MD6173D             |  | FA271TT             | FA271R                             | MD6173D |                               |  |
| Arctic Cat 250 (2 x 4)               | 99-04 | FA271TT*         | FA271R*                            | MD6173D           | MD6173D             |  | FA271TT             | FA271R                             | MD6173D |                               |  |
| 250 (2 x 4)                          | 05-06 |                  | FA395R*                            | MD6173D           | MD6173D             |  |                     | FA395R                             | MD6173D |                               |  |
| DVX 250                              | 06-07 | FA377TT*         | FA377R*                            | MD6267D           | MD6267D             |  | FA355*              | FA355R*                            | MD6268D |                               |  |
| Arctic Cat 300 (2 x 4)               | 98-03 | FA271TT*         | FA271R*                            | MD6173D           | MD6173D             |  | FA271TT             | FA271R                             | MD6173D |                               |  |
| Arctic Cat 300 (4 x 4)               | 98-04 | FA271TT*         | FA271R*                            | MD6173D           | MD6173D             |  | FA271TT             | FA271R                             | MD6173D |                               |  |
| 300 (4 x 4)                          | 05    |                  | FA395R*                            | MD6173D           | MD6173D             |  |                     | FA395R                             | MD6173D |                               |  |
| Arctic Cat 375 (2x4/4x4 Automatic)   | 02    | FA271TT*         | FA271R*                            | MD6173D           | MD6173D             |  | FA271TT             | FA271R                             | MD6173D |                               |  |
| Arctic Cat 400 (2 x 4) Auto & Manual | 98-04 | FA271TT*         | FA271R*                            | MD6173D           | MD6173D             |  | FA271TT             | FA271R                             | MD6173D |                               |  |
| Arctic Cat 400 (4 x 4) Auto & Manual | 98-04 | FA271TT*         | FA271R*                            | MD6173D           | MD6173D             |  | FA271TT             | FA271R                             | MD6173D |                               |  |
| 400 FIS (Manual Transmission)        | 05-07 |                  | FA395R*                            | MD6173D           | MD6173D             |  |                     | FA395R                             | MD6173D |                               |  |
| Parking Brake                        |       | FA271TT          | FA271R                             |                   |                     |  |                     |                                    |         |                               |  |
| 400 4x4 FIS (Automatic Transmission) | 05-07 |                  | FA395R*                            | MD6173D           | MD6173D             |  |                     | FA395R                             | MD6173D |                               |  |
| Parking Brake                        |       | FA271TT          | FA271R                             |                   |                     |  |                     |                                    |         |                               |  |
| DVX 400                              | 04-07 | FA84TT*          | FA84R*                             | MD6210D           | MD6210D             |  | FA137TT             | FA137R                             | MD6211D |                               |  |
| Bear Cat 454 (2 x 4) / (4 x 4)       | 96-97 | FA271TT*         | FA271R*                            | MD6173D           | MD6173D             |  | FA271TT             | FA271R                             | MD6173D |                               |  |
| Arctic Cat 454 (4 x 4 / 2 x 4)       | 98    | FA271TT*         | FA271R*                            | MD6173D           | MD6173D             |  | FA271TT             | FA271R                             | MD6173D |                               |  |
| 500 (4x4/4x4 Auto) (All models)      | 98-04 | FA271TT*         | FA271R*                            | MD6173D           | MD6173D             |  | FA271TT             | FA271R                             | MD6173D |                               |  |
| 500 TRV/TBX (Automatic Transmission) | 05-06 | FA395TT*         | FA395R*                            | MD6173D           | MD6173D             |  | FA395TT             | FA395R                             | MD6173D |                               |  |
| Parking Brake                        |       | FA271TT          | FA271R                             |                   |                     |  |                     |                                    |         |                               |  |
| 500 FIS (Manual & Auto)              | 05-07 |                  | FA395R*                            | MD6173D           | MD6173D             |  | FA395TT             | FA395R                             | MD6173D |                               |  |
| Parking Brake                        |       | FA271TT          | FA271R                             |                   |                     |  |                     |                                    |         |                               |  |
| 650 H1 (4x4 Auto)                    | 05-   | FA395TT*         | FA395R*                            | MD6173D           | MD6173D             |  | FA395TT             | FA395R                             | MD6173D |                               |  |
| Parking brake                        |       |                  |                                    |                   |                     |  |                     | FA271R                             |         |                               |  |
| 650 H1 Auto                          | 06    | FA395TT*         | FA395R*                            | MD6173D           | MD6173D             |  | FA395TT             | FA395R                             | MD6173D |                               |  |
| Parking brake                        |       | FA395TT          | FA395R                             |                   |                     |  |                     |                                    |         |                               |  |
| 650 H1 Prowler                       | 06-07 | FA395TT*         | FA395R*                            | MD6271D           | MD6271D             |  | FA395TT             | FA395R                             |         |                               |  |
| 650 V-Twin Auto FIS                  | 06    | FA395TT*         | FA395R*                            | MD6173D           | MD6173D             |  | FA395TT             | FA395R                             | MD6173D |                               |  |
| Parking brake                        |       | FA395TT          | FA395R                             |                   |                     |  |                     |                                    |         |                               |  |
| 650 V-Twin 4x4 FIS                   | 04-05 | FA395TT*         | FA395R*                            | MD6173D           | MD6173D             |  | FA395TT             | FA395R                             | MD6173D |                               |  |
| Parking Brake                        |       | FA271TT          | FA271R                             |                   |                     |  |                     |                                    |         |                               |  |
| 700 4x4 Auto FIS/EFI                 | 06-07 | FA395TT*         | FA395R*                            | MD6173D           | MD6173D             |  | FA395TT             | FA395R                             | MD6173D |                               |  |
| Parking brake                        |       | FA395TT          | FA395R                             |                   |                     |  |                     |                                    |         |                               |  |

## BOMBARDIER/BRP (See Can-Am section for 2007 models)

|   |            |         |         |         |         |  |           |          |         |  |
|---|------------|---------|---------|---------|---------|--|-----------|----------|---------|--|
| DS 50 (2 stroke)  | 02-06      | H346*   | H346G*  |         |         |  | H330      | H330G    |         |  |
| Quest 50  | 03-04      | H346*   | H346G*  |         |         |  | H330      | H330G    |         |  |
| DS 90 (2 stroke/4 stroke)   | 02-06      | H346*   | H346G*  |         |         |  | H330      | H330G    |         |  |
| DS 250  | 06         | FA377*  | FA377R* | MD6283D | MD6283D |  | FA377     | FA377R   | MD6282D |  |
| Quest 90 (2 stroke/4 stroke)  | 03-04      | H346*   | H346G*  |         |         |  | H330      | H330G    |         |  |
| Rally 200 (7550/7551/7552/7553)   | 03-04      | FA83TT* | FA83R*  | MD6220D | MD6220D |  | N/A       |          | MD6221D |  |
| Rally 200   | 05-07      | FA83TT* | FA83R*  | MD6220D | MD6220D |  | FA165/2TT | FA165/2R | MD6285D |  |
| Outlander 330 HO  | Left 04-05 | FA307TT | FA307R  | MD6222D |         |  | FA307TT   | FA307R   | MD6223D |  |
|   | Right      | FA317TT | FA317R  |         | MD6222D |  |           |          |         |  |
| Outlander 400 (7535/7716)   | Left 03-04 | FA307TT | FA307R  | MD6222D |         |  | FA307TT   | FA307R   | MD6223D |  |
|   | Right      | FA317TT | FA317R  |         | MD6222D |  |           |          |         |  |
| Outlander 400 Max HO  | Left 03-06 | FA307TT | FA307R  | MD6222D |         |  | FA307TT   | FA307R   | MD6223D |  |
|   | Right      | FA317TT | FA317R  |         | MD6222D |  |           |          |         |  |
| Outlander 650 HO Efi 4x4/   | Left 06    | FA307TT | FA307R  | MD6222D |         |  | FA307TT   | FA307R   | MD6223D |  |
| HO Efi XT 4x4   | Right      | FA317TT | FA317R  |         | MD6222D |  |           |          |         |  |
| Outlander Max 650 HO Efi 4x4/   | Left 06    | FA307TT | FA307R  | MD6222D |         |  | FA307TT   | FA307R   | MD6223D |  |
| HO Efi XT 4x4   | Right      | FA317TT | FA317R  |         | MD6222D |  |           |          |         |  |
| Outlander 800 (All models)  | Left 06    | FA307TT | FA307R  | MD6222D |         |  | FA307TT   | FA307R   | MD6223D |  |
|   | Right      | FA317TT | FA317R  |         | MD6222D |  |           |          |         |  |
| Traxter (4x4) (Model types 7400-7408/<br>7413-7422/7425-7428/7455/7456) | 99-00      | FA266*  | FA266R* | MD6229D | MD6229D |  | FA266     | FA266R   | MD6230D |  |

\*-2 Sets Required. ■ - Also available in MX-S race compound, see page 8. ✖ - Oversize and Supermoto disc available - see page 301.

**SAFETY WARNING-** DO NOT USE HH PADS ON REAR UNLESS ALSO USED ON FRONT TO AVOID BRAKE IMBALANCE.



# US Built Motorcycles/Quads



## BOMBARDIER/BRP Contd.

|   |       |       | Front/Avant/Vorn |                                    |                       | Frente/Anteriore        |  | Rear/Arrière/Hinten |                                    |         | Posterior/Posteriore          |  |
|---|-------|-------|------------------|------------------------------------|-----------------------|-------------------------|--|---------------------|------------------------------------|---------|-------------------------------|--|
|   |       |       | 1                | 2                                  | 3                     | 4                       | 5  | 6                   | 7                                  | 8       | 9                             |  |
|   |       |       |                  | Sintered/HH Pads/<br>Grooved shoes | Left/Gauche/Links<br> | Right/Droite/Rechts<br> | Contour Rotor<br>Universal left and<br>right fitment |                     | Sintered/HH Pads/<br>Grooved shoes |         | Contour Rotor<br>Rear fitment |  |
| Traxter (4x4) (Model types 7459/7460)   | Left  |       | FA307TT          | FA307R                             | MD6229D               |                         |  | FA307TT             | FA307R                             | MD6230D |                               |  |
|   | Right | 01    | FA317TT          | FA317R                             |                       | MD6229D                 |  |                     |                                    |         |                               |  |
| Traxter XL (4x4) Up to SN V000708 (Model type 7448)   |       | 01    | FA266*           | FA266R*                            | MD6229D               | MD6229D                 |  | FA266               | FA266R                             | MD6230D |                               |  |
| Traxter XL (4x4) (Model types 7448 from SN V000709/7458/7477 /7489/7565/7571)   | Left  | 01-04 | FA307TT          | FA307R                             | MD6229D               |                         |  | FA317TT             | FA317R                             | MD6230D |                               |  |
|   | Right |       | FA317TT          | FA317R                             |                       | MD6229D                 |  |                     |                                    |         |                               |  |
| Traxter XT (4x4) (Model types 7423/7424)  |       | 00    | FA266*           | FA266R*                            | MD6229D               | MD6229D                 |  | FA266               | FA266R                             | MD6230D |                               |  |
| Traxter XT (4x4) (Model types 7446/7452/7467/7468/7472/7481 /7493/7494)   | Left  | 01    | FA307TT          | FA307R                             | MD6229D               |                         |  | FA317TT             | FA317R                             | MD6230D |                               |  |
|   | Right |       | FA317TT          | FA317R                             |                       | MD6229D                 |  |                     |                                    |         |                               |  |
| Traxter Autoshift (Model types 7431/7432 /7433/7434)  |       | 01    | FA266*           | FA266R*                            | MD6229D               | MD6229D                 |  | FA266               | FA266R                             | MD6230D |                               |  |
| Traxter Autoshift (Model types 7453/7454/7461/7462 /7469/7470/7471/7475/7480/7495/7496/7497 /7560/7561/7562/7563/7564/7566/7567/7568 /7569/7570/7595/7596/7597/7598/7599) | Left  | 01-05 | FA307TT          | FA307R                             | MD6225D               |                         |  | FA317TT             | FA317R                             | MD6224D |                               |  |
|   | Right |       | FA317TT          | FA317R                             |                       | MD6225D                 |  |                     |                                    |         |                               |  |
| Traxter Footshift (Model types 7439/7440 /7441/7442)  |       | 01    | FA266*           | FA266R*                            | MD6229D               | MD6229D                 |  | FA266               | FA266R                             | MD6230D |                               |  |
| Traxter Footshift (Model types 7473/7474)   | Left  |       | FA307TT          | FA307R                             | MD6229D               |                         |  | FA317TT             | FA317R                             | MD6230D |                               |  |
|   | Right | 01    | FA317TT          | FA317R                             |                       | MD6229D                 |  |                     |                                    |         |                               |  |
| Quest 500 (4x4) (Model types 7478/7515 /7525/7539/7540/7546/7547/7583/7584 /7713/7724/7725/7731)  | Left  | 02-04 | FA307TT          | FA307R                             | MD6224D               |                         |  | FA317TT             | FA317R                             | MD6225D |                               |  |
|   | Right |       | FA317TT          | FA317R                             |                       | MD6224D                 |  |                     |                                    |         |                               |  |
| Traxter Max   | Left  | 03-05 | FA307TT          | FA307R                             | MD6245D               |                         |  | FA317TT             | FA317R                             | MD6225D |                               |  |
|   | Right |       | FA317TT          | FA317R                             |                       | MD6245D                 |  |                     |                                    |         |                               |  |
| Quest 500 (2x4) (Model types 7541/7542/7548/7549 /7585/7586/7714/7726)  | Left  | 02    | FA307TT          | FA307R                             | MD6224D               |                         |  | FA317TT             | FA317R                             | MD6225D |                               |  |
|   | Right |       | FA317TT          | FA317R                             |                       | MD6224D                 |  |                     |                                    |         |                               |  |
| Quest 650 (2x4) (Model type 7582)   | Left  | 02    | FA307TT          | FA307R                             | MD6224D               |                         |  | FA317TT             | FA317R                             | MD6225D |                               |  |
|   | Right |       | FA317TT          | FA317R                             |                       | MD6224D                 |  |                     |                                    |         |                               |  |
| Quest 650 (4x4) (Model types 7443/7445/7516 /7517/7523/7536/7537 /7543/7544/7580/7581/7730)   | Left  | 02-04 | FA307TT          | FA307R                             | MD6224D               |                         |  | FA317TT             | FA317R                             | MD6225D |                               |  |
|   | Right |       | FA317TT          | FA317R                             |                       | MD6224D                 |  |                     |                                    |         |                               |  |
| Quest 650 XT (4x4) (Model types 7522/7523/7534/7545/7715 /7727/7728)  | Left  | 02    | FA307TT          | FA307R                             | MD6224D               |                         |  | FA317TT             | FA317R                             | MD6225D |                               |  |
|   | Right |       | FA317TT          | FA317R                             |                       | MD6224D                 |  |                     |                                    |         |                               |  |
| Quest Max 650   | Left  | 03-   | FA307TT          | FA307R                             | MD6224D               |                         |  | FA317TT             | FA317R                             | MD6225D |                               |  |
|   | Right |       | FA317TT          | FA317R                             |                       | MD6224D                 |  |                     |                                    |         |                               |  |
| DS 650 (Model types 7404/7409/7463/7482 /7518/7519/7587/7588-7483)  | Left  | 00-05 | FA307TT          | FA307R                             | MD6171D               |                         |  | FA307TT             | FA307R                             | MD6172D |                               |  |
|   | Right |       | FA317TT          | FA317R                             |                       | MD6171D                 |  |                     |                                    |         |                               |  |
| DS 650 Baja/X   | Left  | 01-06 | FA307TT          | FA307R                             | MD6171D               |                         |  | FA307TT             | FA307R                             | MD6172D |                               |  |
|   | Right |       | FA317TT          | FA317R                             |                       | MD6171D                 |  |                     |                                    |         |                               |  |
| Traxter Max 650   | Left  | 04-05 | FA307TT          | FA307R                             | MD6245D               |                         |  | FA317TT             | FA317R                             | MD6225D |                               |  |
|   | Right |       | FA317TT          | FA317R                             |                       | MD6245D                 |  |                     |                                    |         |                               |  |
| Sarasota 1000 Side x Side   |       | 05    | N/A              |                                    |                       |                         |  | N/A                 |                                    |         |                               |  |
| Traxter XL (7920/7921)  | Left  | 04    | FA307TT          | FA307R                             | MD6245D               |                         |  | FA317TT             | FA317R                             | MD6225D |                               |  |
|   | Right |       | FA317TT          | FA317R                             |                       | MD6245D                 |  |                     |                                    |         |                               |  |
| Quest Max/STD/XT  | Left  | 04-05 | FA307TT          | FA307R                             | MD6245D               |                         |  | FA317TT             | FA317R                             | MD6225D |                               |  |
|   | Right |       | FA317TT          | FA317R                             |                       | MD6245D                 |  |                     |                                    |         |                               |  |

## CAN AM

|  |       |    |         |         |         |         |  |         |        |         |  |
|--|-------|----|---------|---------|---------|---------|--|---------|--------|---------|--|
| DS 90 Mini 4 Stroke (3C7A)                   |       | 07 | H346*   | H346G*  |         |         |  | H330    | H330G  |         |  |
| Rally 200 (4A7A/B/C/D/E/F)                   |       | 07 | FA83TT* | FA83R*  | MD6220D | MD6220D |  | FA307TT | FA307R | MD6285D |  |
| DS 250 (3J7A/B)                              |       | 07 | FA377*  | FA377R* | MD6283D | MD6283D |  | FA377   | FA377R | MD6282D |  |
| Outlander 400 (4x4 STD) (2D7A/B/C/D/E/F/G/H) | Left  | 07 | FA307TT | FA307R  | MD6222D | MD6222D |  | FA307TT | FA307R | MD6223D |  |
|  | Right |    | FA317TT | FA317R  |         |         |  |         |        |         |  |

\*-2 Sets Required. ■ - Also available in MX-S race compound, see page 8. ✕ - Oversize and Supermoto disc available - see page 301.

**SAFETY WARNING-** DO NOT USE HH PADS ON REAR UNLESS ALSO USED ON FRONT TO AVOID BRAKE IMBALANCE.

R Suffix = High Durability Sintered Pad. HH Suffix = High Performance Sintered Pad. G Suffix = Grooved Shoe.  
D Suffix = Drilled Disc. C Suffix = Contoured Disc. LS Suffix = Left/Steel Disc. RS = Right/Steel Disc.

BRAKE APPLICATIONS

# US Built Motorcycles/Quads



## CAN AM Contd.

|                             |       |    | Front/Avant/Vorn               |                   |                     | Frente/Anteriore |                                  | Rear/Arrière/Hinten            |               |              | Posterior/Posteriore |  |
|-----------------------------|-------|----|--------------------------------|-------------------|---------------------|------------------|----------------------------------|--------------------------------|---------------|--------------|----------------------|--|
|                             |       |    | 1                              | 2                 | 3                   | 4                | 5                                | 6                              | 7             | 8            | 9                    |  |
|                             |       |    | Sintered/HH Pads/Grooved shoes | Left/Gauche/Links | Right/Droite/Rechts | Contour Rotor    | Universal left and right fitment | Sintered/HH Pads/Grooved shoes | Contour Rotor | Rear fitment |                      |  |
| Outlander 400 (XT 4x4)      | Left  | 07 | FA307TT                        | FA307R            | MD6222D             |                  |                                  | FA307TT                        | FA307R        | MD6223D      |                      |  |
| (2E7A/B/C/D/E/F)            | Right |    | FA317TT                        | FA317R            |                     | MD6222D          |                                  |                                |               |              |                      |  |
| Outlander Max 400 (STD 4x4) | Left  | 07 | FA307TT                        | FA307R            | MD6222D             |                  |                                  | FA307TT                        | FA307R        | MD6223D      |                      |  |
| (2F7B/C/D/E/F/G/H/J)        | Right |    | FA317TT                        | FA317R            |                     | MD6222D          |                                  |                                |               |              |                      |  |
| Outlander Max 400 (XT 4x4)  | Left  | 07 | FA307TT                        | FA307R            | MD6222D             |                  |                                  | FA307TT                        | FA307R        | MD6223D      |                      |  |
| (2G7A/B/C/D/E)              | Right |    | FA317TT                        | FA317R            |                     | MD6222D          |                                  |                                |               |              |                      |  |
| Outlander 500 (STD 4x4)     | Left  | 07 | FA307TT                        | FA307R            | MD6222D             |                  |                                  | FA307TT                        | FA307R        | MD6223D      |                      |  |
| (2T7A/B/C/D)                | Right |    | FA317TT                        | FA317R            |                     | MD6222D          |                                  |                                |               |              |                      |  |
| Outlander 500 (XT 4x4)      | Left  | 07 | FA307TT                        | FA307R            | MD6222D             |                  |                                  | FA307TT                        | FA307R        | MD6223D      |                      |  |
| (2U7A/B/C/D)                | Right |    | FA317TT                        | FA317R            |                     | MD6222D          |                                  |                                |               |              |                      |  |
| Outlander Max 500 (STD 4x4) | Left  | 07 | FA307TT                        | FA307R            | MD6222D             |                  |                                  | FA307TT                        | FA307R        | MD6223D      |                      |  |
| (2W7A/B/C)                  | Right |    | FA317TT                        | FA317R            |                     | MD6222D          |                                  |                                |               |              |                      |  |
| Outlander Max 500 (XT 4x4)  | Left  | 07 | FA307TT                        | FA307R            | MD6222D             |                  |                                  | FA307TT                        | FA307R        | MD6223D      |                      |  |
| (2X7A/B/C)                  | Right |    | FA317TT                        | FA317R            |                     | MD6222D          |                                  |                                |               |              |                      |  |
| DS 650 X (3B7A/B)           | Left  | 07 | FA307TT                        | FA307R            | MD6171D             |                  |                                  | FA307TT                        | FA307R        | MD6172D      |                      |  |
|                             | Right |    | FA317TT                        | FA317R            |                     | MD6171D          |                                  |                                |               |              |                      |  |
| Outlander 650 (4x4 STD)     | Left  | 07 | FA307TT                        | FA307R            | MD6222D             |                  |                                  | FA307TT                        | FA307R        | MD6223D      |                      |  |
| (2N7A/B/C/D/E/F/G/H)        | Right |    | FA317TT                        | FA317R            |                     | MD6222D          |                                  |                                |               |              |                      |  |
| Outlander 650 (XT 4x4)      | Left  | 07 | FA307TT                        | FA307R            | MD6222D             |                  |                                  | FA307TT                        | FA307R        | MD6223D      |                      |  |
| (2P7A/B/C/D/E/F)            | Right |    | FA317TT                        | FA317R            |                     | MD6222D          |                                  |                                |               |              |                      |  |
| Outlander Max 650 (STD 4x4) | Left  | 07 | FA307TT                        | FA307R            | MD6222D             |                  |                                  | FA307TT                        | FA307R        | MD6223D      |                      |  |
| (2R7A/B/C/D/E/F/G/H/J/K)    | Right |    | FA317TT                        | FA317R            |                     | MD6222D          |                                  |                                |               |              |                      |  |
| Outlander Max 650 (XT 4x4)  | Left  | 07 | FA307TT                        | FA307R            | MD6222D             |                  |                                  | FA307TT                        | FA307R        | MD6223D      |                      |  |
| (2S7A/B/C/D/E/F)            | Right |    | FA317TT                        | FA317R            |                     | MD6222D          |                                  |                                |               |              |                      |  |
| Outlander 800 (STD 4x4)     | Left  | 07 | FA307TT                        | FA307R            | MD6222D             |                  |                                  | FA307TT                        | FA307R        | MD6223D      |                      |  |
| (2H7A/B/C/D/E/F/G/H)        | Right |    | FA317TT                        | FA317R            |                     | MD6222D          |                                  |                                |               |              |                      |  |
| Outlander 800 (XT 4x4)      | Left  | 07 | FA307TT                        | FA307R            | MD6222D             |                  |                                  | FA307TT                        | FA307R        | MD6223D      |                      |  |
| (2J7A/B/C/D/E/F)            | Right |    | FA317TT                        | FA317R            |                     | MD6222D          |                                  |                                |               |              |                      |  |
| Outlander Max 800 (Ltd 4x4) | Left  | 07 | FA307TT                        | FA307R            | MD6222D             |                  |                                  | FA307TT                        | FA307R        | MD6223D      |                      |  |
| (2M7A/B/C)                  | Right |    | FA317TT                        | FA317R            |                     | MD6222D          |                                  |                                |               |              |                      |  |
| Outlander Max 800 (STD 4x4) | Left  | 07 | FA307TT                        | FA307R            | MD6222D             |                  |                                  | FA307TT                        | FA307R        | MD6223D      |                      |  |
| (2K7A/B/C/D/E/F/G/H/J)      | Right |    | FA317TT                        | FA317R            |                     | MD6222D          |                                  |                                |               |              |                      |  |
| Renegade 800 HO EFI 4x4     | Left  | 07 | FA307TT                        | FA307R            | MD6223D             |                  |                                  | FA307TT                        | FA307R        | MD6223D      |                      |  |
|                             | Right |    | FA317TT                        | FA317R            |                     | MD6223D          |                                  |                                |               |              |                      |  |
| Outlander Max 800 (XT 4x4)  | Left  | 07 | FA307TT                        | FA307R            | MD6222D             |                  |                                  | FA307TT                        | FA307R        | MD6223D      |                      |  |
| (2L7A/B/C/D/E/F)            | Right |    | FA317TT                        | FA317R            |                     | MD6222D          |                                  |                                |               |              |                      |  |

## CANNONDALE

|                  |       |       |         |        |     |     |  |         |        |     |  |  |
|------------------|-------|-------|---------|--------|-----|-----|--|---------|--------|-----|--|--|
| FX 400           | Left  | 01    | FA307TT | FA307R | N/A | N/A |  | FA307TT | FA307R | N/A |  |  |
|                  | Right |       | FA317TT | FA317R |     |     |  |         |        |     |  |  |
| Cannibal 440     | Left  | 02-03 | FA307TT | FA307R | N/A | N/A |  | FA307TT | FA307R | N/A |  |  |
|                  | Right |       | FA317TT | FA317R |     |     |  |         |        |     |  |  |
| Speed/Glamis 440 | Left  | 02-03 | FA307TT | FA307R | N/A | N/A |  | FA307TT | FA307R | N/A |  |  |
|                  | Right |       | FA317TT | FA317R |     |     |  |         |        |     |  |  |
| Blaze 440        | Left  | 02-03 | FA307TT | FA307R | N/A | N/A |  | FA307TT | FA307R | N/A |  |  |
|                  | Right |       | FA317TT | FA317R |     |     |  |         |        |     |  |  |
| Moto 440         | Left  | 02-03 | FA307TT | FA307R | N/A | N/A |  | FA307TT | FA307R | N/A |  |  |
|                  | Right |       | FA317TT | FA317R |     |     |  |         |        |     |  |  |

## JOHN DEERE

|                                  |       |       |         |         |         |         |  |         |        |         |  |  |
|----------------------------------|-------|-------|---------|---------|---------|---------|--|---------|--------|---------|--|--|
| Trail Buck 500 Utility           | Left  | 04-05 | FA307TT | FA307R  | MD6245D | MD6245D |  | FA317TT | FA317R | MD6225D |  |  |
|                                  | Right |       | FA317TT | FA317R  |         |         |  |         |        |         |  |  |
| Trail Buck 650/650 EX/EXT        | Left  | 04-05 | FA307TT | FA307R  | MD6245D | MD6245D |  | FA317TT | FA317R | MD6225D |  |  |
|                                  | Right |       | FA317TT | FA317R  |         |         |  |         |        |         |  |  |
| Buck 500/500 EX/EXT              | Left  | 04-05 | FA307TT | FA307R  | MD6245D | MD6245D |  | FA317TT | FA317R | MD6225D |  |  |
|                                  | Right |       | FA317TT | FA317R  |         |         |  |         |        |         |  |  |
| TX Gater Utility 9461            |       | 04-05 |         | FA398R* | N/A     |         |  |         | FA398R | N/A     |  |  |
| TX Turf Gater 9462               |       | 04-05 |         | FA398R* | N/A     |         |  |         | FA398R | N/A     |  |  |
| 4PX Gater 4x2/4x4 4x4 Trail 9345 |       | 04-05 |         | FA398R* |         |         |  |         | FA398R | N/A     |  |  |

\*-2 Sets Required. ■ - Also available in MX-S race compound, see page 8. ✖ - Oversize and Supermoto disc available - see page 301.

**SAFETY WARNING-** DO NOT USE HH PADS ON REAR UNLESS ALSO USED ON FRONT TO AVOID BRAKE IMBALANCE.

# US Built Motorcycles/Quads



## POLARIS

|                                    |       | Front/Avant/Vorn |                                    |                       | Frente/Anteriore        |  | Rear/Arrière/Hinten |                                    |          | Posterior/Posteriore          |  |
|------------------------------------|-------|------------------|------------------------------------|-----------------------|-------------------------|--|---------------------|------------------------------------|----------|-------------------------------|--|
|                                    |       | 1                | 2                                  | 3                     | 4                       | 5  | 6                   | 7                                  | 8        | 9                             |  |
|                                    |       |                  | Sintered/HH Pads/<br>Grooved shoes | Left/Gauche/Links<br> | Right/Droite/Rechts<br> | Contour Rotor<br>Universal left and<br>right fitment |                     | Sintered/HH Pads/<br>Grooved shoes |          | Contour Rotor<br>Rear fitment |  |
| HPX Gater 4x2/4x4 9446             | 04-05 |                  | FA398R*                            | N/A                   |                         |  |                     | FA398R                             | N/A      |                               |  |
| Predator 50 (2 stroke)             | 04-06 | 338*             | 338G*                              |                       |                         |  | 307                 | 307G                               |          |                               |  |
| Scrambler (3 Wheeler)              | 85-86 | 503              | 503G                               |                       |                         |  | FA40TT              |                                    | N/A      |                               |  |
| Scrambler 50                       | 01-03 | 338*             | 338G*                              |                       |                         |  | 307                 | 307G                               |          |                               |  |
| Outlaw 90                          | 07    | 338*             | 338G*                              |                       |                         |  | 307                 | 307G                               |          |                               |  |
| Predator 90                        | 03-06 | 338*             | 338G*                              |                       |                         |  | 307                 | 307G                               |          |                               |  |
| Scrambler 90/90 X                  | 01-03 | 338*             | 338G*                              |                       |                         |  | 307                 | 307G                               |          |                               |  |
| Sportsman 90                       | 01-06 | 338*             | 338G*                              |                       |                         |  | 307                 | 307G                               |          |                               |  |
| Phoenix 200                        | 05    | FA83TT*          | FA83R*                             | MD6219D               | MD6219D                 |  | 306                 | 306G                               |          |                               |  |
| Phoenix 200                        | 06-07 | FA83TT*          | FA83R*                             | MD6274D               | MD6274D                 |  | 306                 | 306G                               |          |                               |  |
| Sawtooth 200                       | 06-07 | FA83TT*          | FA83R*                             | MD6274D               | MD6274D                 |  | 306                 | 306G                               |          |                               |  |
| 250 "2 x 4 / 4 x 4"                | 90    | FA159TT*         | FA159R*                            | MD6149D               | MD6149D                 |  | FA232TT             | FA232R                             | N/A      |                               |  |
| 250 "2 x 4 / 4 x 4"                | 93    | FA159TT*         | FA159R*                            | MD6150D               | MD6150D                 |  | FA232TT             | FA232R                             | N/A      |                               |  |
| Cyclone "250 X"                    | 87    | 503*             | 503G*                              |                       |                         |  | FA40                |                                    | N/A      |                               |  |
| Big Boss 250 "4 x 6"               | 89-90 | FA159TT*         | FA159R*                            | MD6147D               | MD6147D                 |  | FA232TT             | FA232R                             | N/A      |                               |  |
| "Middle Axle Brake"                |       | FA159TT*         | FA159R*                            | MD6149D               |                         |  |                     |                                    |          |                               |  |
| Big Boss 250 "4 x 6"               | 91-92 | FA159TT*         | FA159R*                            | MD6150D               | MD6150D                 |  | FA232TT             | FA232R                             | N/A      |                               |  |
| "Middle Axle Brake"                |       | FA159TT*         | FA159R*                            | MD6149D               |                         |  |                     |                                    |          |                               |  |
| Big Boss 250 "6 x 6"               | 91    | FA159TT*         | FA159R*                            | MD6149D               | MD6149D                 |  | FA232TT             | FA232R                             | N/A      |                               |  |
| "Middle Axle Brake"                |       | FA159TT          | FA159R                             | MD6149D               |                         |  |                     |                                    |          |                               |  |
| Big Boss 250 "6 x 6"               | 92-93 | FA159TT*         | FA159R*                            | MD6150D               | MD6150D                 |  | FA232TT             | FA232R                             | N/A      |                               |  |
| "Middle Axle Brake"                |       | FA159TT*         | FA159R*                            | MD6149D               |                         |  |                     |                                    |          |                               |  |
| Trail Blazer 250                   | 90    | FA159TT*         | FA159R*                            | MD6147D               | MD6147D                 |  | FA232TT             | FA232R                             | N/A      |                               |  |
| Trail Blazer 250                   | 91-93 | FA159TT*         | FA159R*                            | MD6150D               | MD6150D                 |  | FA232TT             | FA232R                             | N/A      |                               |  |
| Trail Blazer "250"                 | 94-98 | FA159TT*         | FA159R*                            | MD6150D               | MD6150D                 |  | FA232TT             | FA232R                             | N/A      |                               |  |
| Trail Blazer "250"                 | 99-00 | FA159TT*         | FA159R*                            | MD6155D               | MD6155D                 |  | FA270TT             | FA270R                             | MD6156D  |                               |  |
| Trail Blazer "250" (Freedom)       | 01-04 | FA159TT*         | FA159R*                            | MD6155D               | MD6155D <sup>1</sup>    |  | FA270TT             | FA270R                             | MD6156D  |                               |  |
| Trail Blazer 250                   | 05-06 | FA159TT*         | FA159R*                            | MD6262D               | MD6262D                 |  | N/A                 | FA314R                             | MD6256D  |                               |  |
| Trail Boss 2 x 4                   | 85-87 | 503*             | 503G*                              |                       |                         |  | FA40TT              |                                    | N/A      |                               |  |
| Trail Boss                         | 88-90 | FA159TT*         | FA159R*                            | MD6147D               | MD6147D                 |  | FA232TT             | FA232R                             | N/A      |                               |  |
| Trail Boss "250"                   | 91-99 | FA159TT*         | FA159R*                            | MD6150D               | MD6150D                 |  | FA232TT             | FA232R                             | N/A      |                               |  |
| Trail Boss "4 x 4"                 | 87    | FA54*            | FA54R*                             | MD6147D               | MD6147D                 |  | FA232TT             | FA232R                             | N/A      |                               |  |
| Trail Boss "2 x 4 / 4 x 4"         | 88-89 | FA159TT*         | FA159R*                            | MD6147D               | MD6147D                 |  | FA232TT             | FA232R                             | N/A      |                               |  |
| Trail Boss 250 "2 x 4 / 4 x 4"     | 91-92 | FA159TT*         | FA159R*                            | MD6150D               | MD6150D                 |  | FA232TT             | FA232R                             | N/A      |                               |  |
| Xplorer 250 (4 x 4)                | 00    | FA159TT*         | FA159R*                            | MD6155D <sup>1</sup>  | MD6155D <sup>1</sup>    |  | FA270TT             | FA270R                             | N/A      |                               |  |
| 300 "2 x 4 / 4 x 4"                | 94-95 | FA159TT*         | FA159R*                            | MD6150D               | MD6150D                 |  | FA232TT             | FA232R                             | N/A      |                               |  |
| Big Boss 300 "6 x 6"               | 94    | FA159TT*         | FA159R*                            | MD6150D               | MD6150D                 |  | FA232TT             | FA232R                             | N/A      |                               |  |
| "Middle Axle Brake"                |       | FA159TT          | FA159R                             |                       | MD6149D                 |  |                     |                                    |          |                               |  |
| Hawkeye 2x4 300                    | 06    | FA395TT*         | FA395R*                            | MD6272D               | MD6272D                 |  | FA395TT*            | FA395R*                            | MD6273D* |                               |  |
| Hawkeye 4x4 300                    | 06    | FA395TT*         | FA395R*                            | MD6272D               | MD6272D                 |  | FA395TT*            | FA395R*                            | MD6273D* |                               |  |
| Hawkeye 2x4/4x4                    | 07    | FA159TT*         | FA159R*                            | MD6272D               | MD6272D                 |  | FA159TT*            | FA159R*                            | MD6273D* |                               |  |
| Xplorer 300 "4 x 4"                | 96-00 | FA159TT*         | FA159R*                            | MD6150D               | MD6150D                 |  | FA232TT             | FA232R                             | N/A      |                               |  |
| Xpress 300 / 400 L                 | 96-97 | FA159TT*         | FA159R*                            | MD6150D               | MD6150D                 |  | FA232TT             | FA232R                             | N/A      |                               |  |
| Xpress 300 "2 x 4"                 | 98-00 | FA159TT*         | FA159R*                            | MD6150D               | MD6150D                 |  | FA232TT             | FA232R                             | N/A      |                               |  |
| Magnum 325 (4 x 4) (2 x 4)         | 00    | FA159TT*         | FA159R*                            | MD6149D               | MD6149D                 |  | FA270TT             | FA270R                             | MD6156D  |                               |  |
| Magnum 325 2x4/4x4 "Mose"          | 01    | FA159TT*         | FA159R*                            | MD6155D               | MD6155D                 |  | FA270TT             | FA270R                             | MD6156D  |                               |  |
| Magnum 325 (2 x 4) HDS             | 02    | FA159TT*         | FA159R*                            | MD6155D               | MD6155D                 |  | N/A                 | FA314R                             | MD6200D  |                               |  |
| Magnum 325 4 x 4 (A02CD32AA/AB/AC) | 02    | FA159TT*         | FA159R*                            | MD6155D               | MD6155D                 |  | N/A                 | FA314R                             | MD6200D  |                               |  |
| Magnum 325 4 x 4 HDS (A02CD32FB)   | 02    | FA159TT*         | FA159R*                            | MD6202D               | MD6202D                 |  | N/A                 | FA314R                             | MD6200D  |                               |  |
| Trail Boss 325                     | 00    | FA159TT*         | FA159R*                            | MD6155D <sup>1</sup>  | MD6155D <sup>1</sup>    |  | FA270TT             | FA270R                             | MD6156D  |                               |  |
| Trail Boss 325                     | 01-02 | FA159TT*         | FA159R*                            | MD6155D <sup>1</sup>  | MD6155D <sup>1</sup>    |  | FA270TT             | FA270R                             | MD6156D  |                               |  |
| Xpedition 325                      | 00    | FA159TT*         | FA159R*                            | MD6155D <sup>1</sup>  | MD6155D <sup>1</sup>    |  | FA270TT             | FA270R                             | MD6156D  |                               |  |
| Xpedition 325                      | 02    | FA159TT*         | FA159R*                            | MD6155D <sup>1</sup>  | MD6155D <sup>1</sup>    |  | N/A                 | FA314R                             | MD6200D  |                               |  |
| ATP 330 (4x4)                      | 04-05 | FA159TT*         | FA159R*                            | MD6202D               | MD6202D                 |  | FA159TT*            | FA159R*                            | MD6200D  |                               |  |
| Magnum 330 (2x4/HDS)               | 03-06 | FA159TT*         | FA159R*                            | MD6149D               | MD6149D                 |  | N/A                 | FA314R                             | MD6200D  |                               |  |
| Magnum 330 (4x4/HDS)               | 03-04 | FA159TT*         | FA159R*                            | MD6202D               | MD6202D                 |  | N/A                 | FA314R                             | MD6200D  |                               |  |
| Trail Boss 330                     | 03-04 | FA159TT*         | FA159R*                            | MD6155D               | MD6155D                 |  | FA270TT             | FA270R                             | MD6156D  |                               |  |
| Trail Boss 330                     | 05-07 | FA159TT*         | FA159R*                            | MD6262D               | MD6262D                 |  | N/A                 | FA314R                             | MD6256D  |                               |  |
| Sportsman 335 '4 x 4'              | 99-00 | FA159TT*         | FA159R*                            | MD6150D               | MD6150D                 |  | FA270TT             | FA270R                             | N/A      |                               |  |
| Sportsman/Worker 335 "4 x 4"       | 99-00 | FA159TT*         | FA159R*                            | MD6149D               | MD6149D                 |  | FA270TT             | FA270R                             | N/A      |                               |  |

\*-2 Sets Required. ■ - Also available in MX-S race compound, see page 8. ✖ - Oversize and Supermoto disc available - see page 301.

**SAFETY WARNING-** DO NOT USE HH PADS ON REAR UNLESS ALSO USED ON FRONT TO AVOID BRAKE IMBALANCE.

R Suffix = High Durability Sintered Pad. HH Suffix = High Performance Sintered Pad. G Suffix = Grooved Shoe.  
D Suffix = Drilled Disc. C Suffix = Contoured Disc. LS Suffix = Left/Steel Disc. RS = Right/Steel Disc.

BRAKE  
APPLICATIONS

# US Built Motorcycles/Quads



Front/Avant/Vorn



Frente/Anteriore

Rear/Arrière/Hinten



Posterior/Posteriore

1

2

3

4

5

6

7

8

9

## POLARIS Contd.

|  |       | 1                                  | 2                 | 3                   | 4  | 5 | 6                                  | 7       | 8                             | 9 |
|--|-------|------------------------------------|-------------------|---------------------|--|---|------------------------------------|---------|-------------------------------|---|
|  |       | Sintered/HH Pads/<br>Grooved shoes | Left/Gauche/Links | Right/Droite/Rechts | Contour Rotor<br>Universal left and<br>right fitment |   | Sintered/HH Pads/<br>Grooved shoes |         | Contour Rotor<br>Rear fitment |   |
| 350 L "2 x 4"                              | 90    | FA159TT*                           | FA159R*           | MD6150D             | MD6150D  |   | FA232TT                            | FA232R  | N/A                           |   |
| 350 L "4 x 4"                              | 90    | FA159TT*                           | FA159R*           | MD6149D             | MD6149D  |   | FA232TT                            | FA232R  | N/A                           |   |
| 350 L "4 x 4"                              | 93    | FA159TT*                           | FA159R*           | MD6150D             | MD6150D  |   | FA232TT                            | FA232R  | N/A                           |   |
| Big Boss 350 L                             | 93    | FA159TT*                           | FA159R*           | MD6149D             | MD6149D  |   | FA232TT                            | FA232R  | N/A                           |   |
| "Middle Axle Brake"                        |       | FA159TT*                           | FA159R*           | MD6149D             |  |   |                                    |         |                               |   |
| Sportsman 350 "4 x 4"                      | 93    | FA159TT*                           | FA159R*           | MD6149D             | MD6149D  |   | FA232TT                            | FA232R  | N/A                           |   |
| Trail Boss 350 L "2 x 4"                   | 91-93 | FA159TT*                           | FA159R*           | MD6150D             | MD6150D  |   | FA232TT                            | FA232R  | N/A                           |   |
| Trail Boss 350 L "4 x 4"                   | 91    | FA159TT*                           | FA159R*           | MD6149D             | MD6149D  |   | FA232TT                            | FA232R  | N/A                           |   |
| 400 L "2 x 4"                              | 94-95 | FA159TT*                           | FA159R*           | MD6150D             | MD6150D  |   | FA232TT                            | FA232R  | N/A                           |   |
| 400 L "4 x 4"                              | 94    | FA159TT*                           | FA159R*           | MD6149D             | MD6149D  |   | FA232TT                            | FA232R  | N/A                           |   |
| Big Boss 400 L "6 x 6"                     | 94-95 | FA159TT*                           | FA159R*           | MD6149D             | MD6149D  |   | FA232TT                            | FA232R  | N/A                           |   |
| "Middle Axle Brake"                        |       | FA159TT                            | FA159R            | MD6149D             |  |   |                                    |         |                               |   |
| Big Boss 400 L "6 x 6"                     | 96    | FA159TT*                           | FA159R*           | MD6149D             | MD6149D  |   | FA232TT                            | FA232R  | N/A                           |   |
| "Middle Axle Brake"                        |       |                                    | FA273R            | MD6153D             |  |   |                                    |         |                               |   |
| Big Boss 400 L "6 x 6"                     | 97    | FA159TT*                           | FA159R*           | MD6149D             | MD6149D  |   | FA232TT                            | FA232R  | N/A                           |   |
| "Middle Axle Brake"                        |       | FA159TT*                           | FA159R*           | MD6149D             |  |   |                                    |         |                               |   |
| Scrambler 400 L "4 x 4"                    | 95-97 | FA159TT*                           | FA159R*           | MD6150D             | MD6150D  |   | FA232TT                            | FA232R  | N/A                           |   |
| Scrambler 400 (2 x 4 / 4 x 4)              | 00    | FA159TT*                           | FA159R*           | MD6155D             | MD6155D  |   | FA270TT                            | FA270R  | MD6156D                       |   |
| Scrambler 400 "4 x 4"                      | 98-02 | FA159TT*                           | FA159R*           | MD6155D             | MD6155D  |   | FA270TT                            | FA270R  | MD6156D                       |   |
| Scrambler 400 2 x 4                        | 02    | FA159TT*                           | FA159R*           | MD6155D             | MD6155D  |   | FA270TT                            | FA270R  | MD6156D                       |   |
| Sport 400 L                                | 94-98 | FA159TT*                           | FA159R*           | MD6150D             | MD6150D  |   | FA232TT                            | FA232R  | N/A                           |   |
| Sport 400                                  | 99-00 | FA159TT*                           | FA159R*           | MD6150D             | MD6150D  |   | FA270TT                            | FA270R  | MD6156D                       |   |
| Sportsman 400 L "4 x 4"                    | 94-97 | FA159TT*                           | FA159R*           | MD6149D             | MD6149D  |   | FA232TT                            | FA232R  | N/A                           |   |
| Sportsman 400                              | 01-02 | FA159TT*                           | FA159R*           | MD6149D             | MD6149D  |   | FA270TT                            | FA270R  | N/A                           |   |
| Sportsman 400                              | 03-05 | FA159TT*                           | FA159R*           | MD6149D             | MD6149D  |   | N/A                                | FA314R  | N/A                           |   |
| Trail Blazer 400                           | 03    | FA159TT*                           | FA159R*           | MD6155D             | MD6155D  |   | FA270TT                            | FA270R  | MD6156D                       |   |
| Xplorer 400 L "4 x 4"                      | 95-98 | FA159TT*                           | FA159R*           | MD6149D             | MD6149D  |   | FA232TT                            | FA232R  | N/A                           |   |
| Xplorer 400 L (4 x 4)                      | 99-00 | FA159TT*                           | FA159R*           | MD6149D             | MD6149D  |   | FA270TT                            | FA270R  | MD6169D                       |   |
| Xplorer 4x4 "400"                          | 01-02 | FA159TT*                           | FA159R*           | MD6155D             | MD6155D  |   | FA270TT                            | FA270R  | MD6156D                       |   |
| Xplorer 400                                | 01-02 | FA159TT*                           | FA159R*           | MD6149D             | MD6149D  |   | FA270TT                            | FA270R  | MD6169D                       |   |
| Magnum 425 "2 x 4"                         | 95-98 | FA159TT*                           | FA159R*           | MD6150D             | MD6150D  |   | FA232TT                            | FA232R  | N/A                           |   |
| Magnum 425 "4 x 4"                         | 95-98 | FA159TT*                           | FA159R*           | MD6149D             | MD6149D  |   | FA232TT                            | FA232R  | N/A                           |   |
| Magnum 425 "6 x 6"                         | 96    | FA159TT*                           | FA159R*           | MD6149D             | MD6149D  |   | FA232TT                            | FA232R  | N/A                           |   |
| "Middle Axle Brake"                        |       |                                    | FA273R            | MD6153D             |  |   |                                    |         |                               |   |
| Magnum 425 "6 x 6"                         | 97    | FA159TT*                           | FA159R*           | MD6149D             | MD6149D  |   | FA232TT                            | FA232R  | N/A                           |   |
| "Middle Axle Brake"                        |       | FA159TT*                           | FA159R*           | MD6149D             | MD6149D  |   |                                    |         |                               |   |
| Xpedition 425 (4 x 4)                      | 00    | FA159TT*                           | FA159R*           | MD6149D             | MD6149D  |   | FA270TT                            | FA270R  | MD6156D                       |   |
| Sportsman 450                              | 06    | FA159TT*                           | FA159R*           | MD6202D             | MD6202D  |   | N/A                                | FA314R  | MD6201D                       |   |
| Sportsman 450                              | 07    | FA159TT*                           | FA159R*           | MD6202D             | MD6202D  |   |                                    | FA314R  | MD6275D                       |   |
| Diesel 455cc 4 x 4 EBS                     | 99-00 | FA159TT*                           | FA159R*           | MD6149D             | MD6149D  |   | FA270TT                            | FA270R  | N/A                           |   |
| Diesel 455cc                               | 01    | FA159TT*                           | FA159R*           | MD6149D             | MD6149D  |   | FA270TT                            | FA270R  | N/A                           |   |
| ATP 500 H0 (4x4)                           | 04-05 | FA159TT*                           | FA159R*           | MD6202D             | MD6202D  |   | FA159TT*                           | FA159R* | MD6202D                       |   |
| ATV Pro 500 4x4 PPS                        | 02    | FA159TT*                           | FA159R*           | MD6202D             | MD6202D  |   | N/A                                | FA314R  | MD6200D                       |   |
| Big Boss 500 "6 x 6"                       | 98-99 | FA159TT*                           | FA159R*           | MD6149D             | MD6149D  |   | FA232TT                            | FA232R  | N/A                           |   |
| "Middle Axle Brake"                        |       | FA159TT                            | FA159R            | MD6149D             |  |   |                                    |         |                               |   |
| Magnum 500 (4 x 4)                         | 99-00 | FA159TT*                           | FA159R*           | MD6149D             | MD6149D  |   | FA270TT                            | FA270R  | MD6156D                       |   |
| Magnum 500                                 | 01    | FA159TT*                           | FA159R*           | MD6149D             | MD6149D  |   | FA270TT                            | FA270R  | MD6156D                       |   |
| Magnum 500 (2 x 4/4 x 4 HDS)               | 02    | FA159TT*                           | FA159R*           | MD6149D             | MD6149D  |   | N/A                                | FA314R  | MD6200D                       |   |
| Magnum 500 4x4 HDS                         | 02-03 | FA159TT*                           | FA159R*           | MD6202D             | MD6202D  |   | N/A                                | FA314R  | MD6200D                       |   |
| Outlaw 500                                 | 06-07 | FA159TT*                           | FA159R*           | MD6219D             |  |   | FA159TT                            | FA159R  | MD6290D                       |   |
| Predator 500/TLD 500                       | 03-07 | FA159TT*                           | FA159R*           | MD6219D             | MD6219D  |   | FA159TT                            | FA159R  | MD6218D                       |   |
| Scrambler 500 "4 x 4"                      | 97    | FA159TT*                           | FA159R*           | MD6150D             | MD6150D  |   | FA232TT                            | FA232R  | N/A                           |   |
| Scrambler 500 "4 x 4"                      | 98-04 | FA159TT*                           | FA159R*           | MD6155D             | MD6155D  |   | FA270TT                            | FA270R  | MD6156D                       |   |
| Scrambler 500 "2x4"                        | 01-02 | FA159TT*                           | FA159R*           | MD6155D             | MD6155D  |   | FA270TT                            | FA270R  | MD6156D                       |   |
| Scrambler 500 "4 x 4"                      | 05-06 | FA159TT                            | FA159R            | MD6155D             |  |   | N/A                                | FA314R  | MD6256D                       |   |
| Scrambler 500 2x4                          | 07    | FA159TT*                           | FA159R*           | MD6262D             | MD6262D  |   |                                    | FA314R  | MD6256D                       |   |
| Scrambler 500 4x4                          | 07    | FA159TT*                           | FA159R*           | TBA                 | TBA  |   |                                    | FA314R  | MD6256D                       |   |
| Sportsman 500 "4 x 4"                      | 96    | FA159TT*                           | FA159R*           | MD6149D             | MD6149D  |   | FA232TT                            | FA232R  | MD6201D                       |   |
| Sportsman 500 "4 x 4"                      | 97    | FA159TT*                           | FA159R*           | MD6149D             | MD6149D  |   | FA232TT                            | FA232R  | MD6154D                       |   |
| Sportsman/Worker 500 "4 x 4" 'EBS'/500 RSE | 98-02 | FA159TT*                           | FA159R*           | MD6149D             | MD6149D  |   | FA270TT                            | FA270R  | N/A                           |   |

\*-2 Sets Required. ■ - Also available in MX-S race compound, see page 8. ✖ - Oversize and Supermoto disc available - see page 301.

**SAFETY WARNING- DO NOT USE HH PADS ON REAR UNLESS ALSO USED ON FRONT TO AVOID BRAKE IMBALANCE.**

# US Built Motorcycles/Quads



## POLARIS Contd.

|                                  |       | Front/Avant/Vorn |                                    |                       | Frente/Anteriore        |   | Rear/Arrière/Hinten |                                    |          | Posterior/Posteriore          |  |
|----------------------------------|-------|------------------|------------------------------------|-----------------------|-------------------------|---|---------------------|------------------------------------|----------|-------------------------------|--|
|                                  |       | 1                | 2                                  | 3                     | 4                       | 5   | 6                   | 7                                  | 8        | 9                             |  |
|                                  |       |                  | Sintered/HH Pads/<br>Grooved shoes | Left/Gauche/Links<br> | Right/Droite/Rechts<br> | Contour Rotor<br>Universal left and right fitment |                     | Sintered/HH Pads/<br>Grooved shoes |          | Contour Rotor<br>Rear fitment |  |
| Sportsman 500 HO/EFI             | 03-06 | FA159TT*         | FA159R*                            | MD6202D               | MD6202D                 |   | N/A                 | FA314R                             | MD6201D  |                               |  |
| Sportsman 500 EFI                | 07    | FA159TT*         | FA159R*                            | MD6202D               | MD6202D                 |   |                     | FA314R                             | MD6275D  |                               |  |
| Sportsman 500 X2                 | 06    | FA159TT*         | FA159R*                            | MD6202D               | MD6202D                 |   |                     | FA314R                             | MD6275D  |                               |  |
| Sportsman 6 x 6 (500) 'Big Boss' | 00-06 | FA159TT*         | FA159R*                            | MD6149D               | MD6149D                 |   | N/A                 | FA313R                             | MD6170D  |                               |  |
| Sportsman 500 EFI Intl           | 07    | FA159TT*         | FA159R*                            | MD6202D               | MD6202D                 |   |                     | FA314R                             | MD6275D  |                               |  |
| Sportsman X 2 500 EFI            | 07    | FA159TT*         | FA159R*                            | MD6202D               | MD6202D                 |   | FA159TT*            | FA159R*                            | MD6275D  |                               |  |
| Sportsman X 2 500 EFI Quad       | 07    | FA159TT*         | FA159R*                            | MD6202D               | MD6202D                 |   |                     | FA314R                             | MD6275D  |                               |  |
| Sportsman 6x6                    | 07    | FA159TT*         | FA159R*                            | MD6149D               | MD6149D                 |   |                     | FA313R*                            | TBA      |                               |  |
| Xplorer 500 "4 x 4"              | 97    | FA159TT*         | FA159R*                            | MD6149D               | MD6149D                 |   | FA232TT             | FA232R                             | N/A      |                               |  |
| Sportsman 600 4x4                | 03-05 | FA159TT*         | FA159R*                            | MD6202D               | MD6202D                 |   | N/A                 | FA314R*                            | MD6201D  |                               |  |
| Sportsman 700 (4x4)/EFI          | 02-06 | FA159TT*         | FA159R*                            | MD6202D               | MD6202D                 |   | N/A                 | FA314R*                            | MD6201D  |                               |  |
| Sportsman MV 700                 | 05-06 | FA159TT*         | FA159R*                            | MD6202D               | MD6202D                 |   |                     | FA314R                             | MD6201D  |                               |  |
| Sportsman 700 EFI                | 07    | FA159TT*         | FA159R*                            | MD6202D               | MD6202D                 |   |                     | FA314R                             | MD6275D  |                               |  |
| Sportsman 800 EFI                | 05-07 | FA159TT*         | FA159R*                            | MD6202D               | MD6202D                 |   |                     | FA314R                             | MD6201D  |                               |  |
| Sportsman X 2 800 EFI            | 07    | FA159TT*         | FA159R*                            | MD6202D               | MD6202D                 |   | FA159TT*            | FA159R*                            | MD6275D  |                               |  |
| Sportsman 800 EFI Intl           | 07    | FA159TT*         | FA159R*                            | MD6202D               | MD6202D                 |   |                     | FA314R                             | MD6275D  |                               |  |
| PPS/PTV 4x4/Series 10            |       | FA159TT*         | FA159R*                            | MD6202D               | MD6202D                 |   |                     | FA314R                             | MD6200D  |                               |  |
| PPS/PTV 6x6/Series 10            |       | FA159TT*         | FA159R*                            | MD6149D               | MD6149D                 |   |                     | FA313R                             | MD6200D  |                               |  |
| PPS/UTV 2x4 Series 10            |       |                  | FA354R                             | MD6202D               | MD6202D                 |   |                     | FA354R*                            | MD6201D  |                               |  |
| PPS/UTV 4x6 Series 10            |       |                  | FA354R*                            | MD6202D               | MD6202D                 |   |                     | FA354R*                            | MD6201D  |                               |  |
| PPS/UTV 1500 2x4 Series 11       |       |                  | FA354R*                            | MD6202D               | MD6202D                 |   |                     | FA354R*                            | MD6201D  |                               |  |
| PPS LUH 6x6                      | 02    | FA159TT*         | FA159R*                            | MD6149D               | MD6149D                 |   |                     | FA313R                             | MD6170D  |                               |  |
| PPS/Series 11 2x4/4x4            |       |                  | FA354R*                            | MD6202D               | MD6202D                 |   |                     | FA354R*                            | MD6201D* |                               |  |
| PPS/Series 11 6x6                |       |                  | FA354R*                            | MD6202D               | MD6202D                 |   |                     | FA354R*                            | MD6201D* |                               |  |
| Ranger (Note: Middle brake N/A)  | 99    | FA159TT*         | FA159R*                            | MD6149D               | MD6149D                 |   |                     | FA273R                             | N/A      |                               |  |
| Ranger Series 10                 |       |                  | FA354R*                            | MD6202D               | MD6202D                 |   |                     | FA354R*                            | MD6201D* |                               |  |
| Ranger Series 10 "500 6x6"       |       |                  | FA354R*                            | MD6202D               | MD6202D                 |   |                     | FA354R*                            | MD6201D* |                               |  |
| Ranger 2x4/4x4                   | 04-05 |                  | FA354R                             | MD6202D               | MD6202D                 |   |                     | FA354R*                            | MD6201D* |                               |  |
| Ranger 500 (2x4/4x4)             | 06-07 |                  | FA354R*                            | MD6202D               | MD6202D                 |   |                     | FA354R*                            | MD6275D* |                               |  |
| Ranger 500 (4x4 EFI)             | 06-07 |                  | FA354R*                            | MD6202D               | MD6202D                 |   |                     | FA354R*                            | MD6275D* |                               |  |
| Ranger Series 11                 |       |                  | FA354R*                            | MD6202D               | MD6202D                 |   |                     | FA354R*                            | MD6201D  |                               |  |
| Ranger 6x6                       | 04-05 |                  | FA354R*                            | MD6202D               | MD6202D                 |   |                     | FA354R*                            | MD6201D* |                               |  |
| Ranger 6x6 EFI 700               | 06    |                  | FA354R*                            | MD6202D               | MD6202D                 |   |                     | FA354R*                            | MD6275D* |                               |  |
| Ranger XP 700 4x4                | 06    |                  | FA354R*                            | MD6202D               | MD6202D                 |   |                     | FA354R*                            | MD6275D* |                               |  |
| Ranger TM                        | 04-05 |                  | FA354R*                            | MD6202D               | MD6202D                 |   |                     | FA354R*                            | MD6201D* |                               |  |
| Ranger TM                        | 06    |                  | FA354R*                            | MD6202D               | MD6202D                 |   |                     | FA354R*                            | MD6275D* |                               |  |
| Ranger XP                        | 05    |                  | FA354R*                            | MD6202D               | MD6202D                 |   |                     | FA354R*                            | MD6201D* |                               |  |

<sup>1</sup>NOTE: Plain edged rotor will not allow fitment of optional speedo pick up.  
<sup>2</sup> For 6x6 model 4 rear discs required

\*-2 Sets Required. ■ - Also available in MX-S race compound, see page 8. ✖ - Oversize and Supermoto disc available - see page 301.

**SAFETY WARNING-** DO NOT USE HH PADS ON REAR UNLESS ALSO USED ON FRONT TO AVOID BRAKE IMBALANCE.

**R** Suffix = High Durability Sintered Pad. **HH** Suffix = High Performance Sintered Pad. **G** Suffix = Grooved Shoe.  
**D** Suffix = Drilled Disc. **C** Suffix = Contoured Disc. **LS** Suffix = Left/Steel Disc. **RS** = Right/Steel Disc.

**BRAKE APPLICATIONS**

# Non-Japanese Built Motorcycles/Quads



Front/Avant/Vorn



Frente/Anteriore

Rear/Arrière/Hinten



Posterior/Posteriore

1

2

3

4

5

6

7

8

9



## ACCOSSATO

|                             |     |      |       |     |  |  |  |       |  |     |
|-----------------------------|-----|------|-------|-----|--|--|--|-------|--|-----|
| 50 Cross Mini               | 82- |      | 926WG |     |  |  |  | 926WG |  |     |
| 50/80 Cross/Enduro          | 83- |      | 841WG |     |  |  |  | 841WG |  |     |
| C 50 Cross/Enduro/Compet.   | 84- |      | 841WG |     |  |  |  | 841WG |  |     |
| CE 80/125 Cross/Enduro H 20 | 84- |      | 940WG |     |  |  |  | 841WG |  |     |
| CE 50/80/KR 80              | 87- | FA47 | FA47R | N/A |  |  |  | FA116 |  | N/A |
| Enduro Codice 50            | 89- | FA47 | FA47R | N/A |  |  |  | FA116 |  | N/A |

## ADLY

|                           |       |         |         |        |        |  |  |        |        |        |
|---------------------------|-------|---------|---------|--------|--------|--|--|--------|--------|--------|
| 50 RS Supersonic          | 06    | FA83TT* | FA83HH* | N/A    | N/A    |  |  | FA83TT | FA83HH | N/A    |
| Jet 50/100 (X-1)          |       | FA83TT  | FA83HH  | MD904D |        |  |  | Y503   |        |        |
| City Bird                 |       | FA169   | FA169HH | TBA    |        |  |  | Y503   |        |        |
| Predator 50/100           |       | FA83TT* | FA83HH* | MD923D | MD923D |  |  | Y503   |        |        |
| Fox 50                    |       | FA169   | FA169HH | MD904D |        |  |  | Y503   |        |        |
| Panther 50/100            | 02-06 | FA83TT  | FA83HH  | TBA    |        |  |  | Y503   |        |        |
| Cosy 50/80                | 02-06 | FA83TT  | FA83HH  | TBA    |        |  |  | Y503   |        |        |
| RT 50/100                 |       | FA83TT  | FA83HH  | TBA    |        |  |  | 897    |        |        |
| Road Tracer 50/90/100     | 04-06 | FA169   | FA169HH | MD904D |        |  |  | Y503   |        |        |
| Silver Fox 50/100         | 06    | FA83TT  | FA83HH  | N/A    |        |  |  | Y503   |        |        |
| SS 50 1/11 Supersonic     | 04-05 | FA83TT  | FA83HH  | MD923D |        |  |  | Y503   |        |        |
| Z-1 Quad 50/90/100        | 06    | TBA*    |         |        |        |  |  | TBA    |        |        |
| Z-2 Quad 90               | 06    | TBA*    |         |        |        |  |  | TBA    |        |        |
| SS 100 1/11 Supersonic    | 04-05 | FA83TT  | FA83HH  | MD923D |        |  |  | Y503   |        |        |
| Activator/Thunderbike 125 |       | FA83TT  | FA83HH  | MD923D |        |  |  | FA83TT | FA83HH | MD982D |
| SS 125 B/D Supersonic     | 04-05 | FA83TT  | FA83HH  | MD923D |        |  |  | FA83TT | FA83HH | MD982D |
| 150 Crusader Quad         | 06    | FA83TT* | FA83R*  | N/A    | N/A    |  |  | FA83TT | FA83R  | N/A    |
| 150 Interceptor           | 06    | FA83TT* | FA83R*  | N/A    | N/A    |  |  | FA83TT | FA83R  | N/A    |
| Interceptor 300           | 06    | FA377*  | FA377R* | N/A    | N/A    |  |  | FA83TT | FA38R  | N/A    |
| 300 Crusader Quad         | 06    | FA83TT* | FA83R*  | N/A    | N/A    |  |  | FA83TT | FA83R  | N/A    |

## AEON

|                                      |       |         |        |         |         |  |  |         |        |     |
|--------------------------------------|-------|---------|--------|---------|---------|--|--|---------|--------|-----|
| Aero 50/100 (Scooter)                | 06    | FA83TT  | FA83R  | N/A     |         |  |  | TBA     |        |     |
| Argon 50 (Scooter)                   | 04-06 | TBA     |        | N/A     |         |  |  | TBA     |        |     |
| Boy X 50 (Bike)                      | 04-06 | TBA     |        |         |         |  |  | TBA     |        |     |
| Cobra 60 (AT30 Type) (Quad)          | 04-06 | TBA*    |        |         |         |  |  | TBA     |        |     |
| Echo 50 (Scooter)                    | 04-06 | TBA     |        | N/A     |         |  |  | TBA     |        |     |
| Minikolt 50 (AT06 Type) (Quad)       | 03-06 | TBA*    |        |         |         |  |  | TBA     |        |     |
| Nox 50/100/125/150 Scooter           | 06    | FA83TT  | FA83R  | N/A     |         |  |  | TBA     |        |     |
| Regal 50/90 (Scooter)                | 06    | FA83TT  | FA83R  | N/A     |         |  |  | TBA     |        |     |
| Revo R50 Cobra 2 (AT34 Type) (Quad)  | 04-06 | TBA*    |        |         |         |  |  | FA83TT  | FA83R  | N/A |
| X-Fast 50                            | 06    | TBA     |        | N/A     |         |  |  | TBA     |        |     |
| Cobra 100 (AT30 Type) (Quad)         | 04-06 | TBA*    |        |         |         |  |  | TBA     |        |     |
| Pulsar 100/125/150 (Scooter)         | 06    | FA83TT  | FA83R  | N/A     |         |  |  | TBA     |        |     |
| Revo R100 Cobra 2 (AT34 Type) (Quad) | 04-06 | TBA*    |        |         |         |  |  | FA83TT  | FA83R  | N/A |
| X-Fast 110 (Bike)                    | 06    | TBA     |        | N/A     |         |  |  | TBA     |        |     |
| Overland 125 (AT08) (Quad)           | 02-06 | TBA     |        |         |         |  |  | FA165TT | FA165R | N/A |
| Sporty 125 (AT05 Type) (Quad)        | 01-05 | TBA*    |        |         |         |  |  | FA83TT  | FA83R  | N/A |
| Cobra RS 180 (Quad)                  | 06    | TBA*    |        |         |         |  |  | FA165TT | FA165R | N/A |
| Overland 180 (AT08) (Quad)           | 02-06 | TBA*    |        |         |         |  |  | FA165TT | FA165R | N/A |
| Sporty 180 (AT05 Type) (Quad)        | 04-05 | TBA*    |        |         |         |  |  | FA83TT  | FA83R  | N/A |
| 200 Two Hundred Quad                 | 06    | FA83TT* | FA83R* | N/A     | N/A     |  |  | FA83TT  | FA83R  | N/A |
| Cobra 220 (Quad)                     | 06-07 | FA83TT* | FA83R* | MD6274D | MD6274D |  |  | TBA     | TBA    | N/A |
| Overland 300 (Quad) (AT20)           | 06-07 | FA83TT* | FA83R* | MD6274D | MD6274D |  |  | FA83TT  | FA83R  | N/A |

## AGRALE

|                |  |      |       |     |  |  |  |     |  |  |
|----------------|--|------|-------|-----|--|--|--|-----|--|--|
| Elefantre 30.0 |  | FA47 | FA47R | N/A |  |  |  | 845 |  |  |
|----------------|--|------|-------|-----|--|--|--|-----|--|--|

## AJP

|                         |       |       |         |     |  |  |  |       |  |     |
|-------------------------|-------|-------|---------|-----|--|--|--|-------|--|-----|
| PR4-Enduro 125/200      | 04-07 | FA167 | FA167HH | N/A |  |  |  | FA303 |  | N/A |
| PR4-Supermotard 125/200 | 04-07 | FA167 | FA167HH | N/A |  |  |  | FA303 |  | N/A |

\*-2 Sets Required. ■ - Also available in MX-S race compound, see page 8. ✖ - Oversize and Supermoto disc available - see page 301.

**SAFETY WARNING-** DO NOT USE HH PADS ON REAR UNLESS ALSO USED ON FRONT TO AVOID BRAKE IMBALANCE.

# Non-Japanese Built Motorcycles/Quads



## AJS

|                       |       | Front/Avant/Vorn |         |   | Frente/Anteriore |         | Rear/Arrière/Hinten |   |        | Posterior/Posteriore |  |
|-----------------------|-------|------------------|---------|---|------------------|---------|---------------------|---|--------|----------------------|--|
|                       |       | 1                | 2       | 3 | 4                | 5       | 6                   | 7 | 8      | 9                    |  |
| Regal Raptor DD 50 E  | 04-06 | TBA              |         |   |                  |         | TBA                 |   |        |                      |  |
| Regal Raptor DD 125 E | 04-06 | FA197            | FA197HH |   |                  | N/A     | TBA                 |   |        |                      |  |
| Regal Raptor CR3-125  | 06    | FA375            |         |   |                  | MD644RS | FA343               |   | MD1151 |                      |  |
| Regal Raptor DD 250 E | 04-06 | FA197            | FA197HH |   |                  | N/A     | TBA                 |   |        |                      |  |
| Regal Raptor DD 100 E | 04-06 | TBA              |         |   |                  |         | TBA                 |   |        |                      |  |

## ALFER

|                            |       |         |        |     |  |  |         |        |     |  |
|----------------------------|-------|---------|--------|-----|--|--|---------|--------|-----|--|
| 80 MC                      | 87-   | FA47TT  | FA47R  | N/A |  |  | FA115TT | FA115R | N/A |  |
| 125 MC                     | 87    | FA47TT  | FA47R  | N/A |  |  | N/A     |        |     |  |
| 125 MC                     | 88-   | FA126TT | FA126R | N/A |  |  | FA47TT  | FA47R  | N/A |  |
| VRE 125 4T                 | 98-   | FA181TT | FA181R | N/A |  |  | FA208TT | FA208R | N/A |  |
| AR 250                     | 93-   | FA185TT | FA185R | N/A |  |  | FA67TT  | FA67R  | N/A |  |
| Divertida 250 Super Motard | 01-   | FA181TT | FA181R | N/A |  |  | FA208TT | FA208R | N/A |  |
| Diferente Enduro           | 01-   | FA181TT | FA181R | N/A |  |  | FA208TT | FA208R | N/A |  |
| 250 MC                     | 85-86 | FA47TT  | FA47R  | N/A |  |  | N/A     |        |     |  |
| 250 MC                     | 87    | FA47TT  | FA47R  | N/A |  |  | FA47TT  | FA47R  | N/A |  |
| 250 MC                     | 88-   | FA126TT | FA126R | N/A |  |  | FA47TT  | FA47R  | N/A |  |
| 250 GR/Enduro              | 85-87 | FA47TT  | FA47R  | N/A |  |  | N/A     |        |     |  |
| 250 GR/Enduro              | 88-   | FA126TT | FA126R | N/A |  |  | FA47TT  | FA47R  | N/A |  |
| VR 250                     | 98-   | FA181TT | FA181R | N/A |  |  | FA208TT | FA208R | N/A |  |
| 300 GR Enduro              | 85-87 | FA47TT  | FA47R  | N/A |  |  | N/A     |        |     |  |
| 300 GR Enduro              | 88-   | FA126TT | FA126R | N/A |  |  | FA47TT  | FA47R  | N/A |  |

## ANCILLOTTI

|                     |     |  |       |  |  |  |  |       |  |  |
|---------------------|-----|--|-------|--|--|--|--|-------|--|--|
| PS 80/PST 125 MX/GS | 83- |  | 841WG |  |  |  |  | 841WG |  |  |
| PSV 250 MX          | 83- |  | 841WG |  |  |  |  | 843WG |  |  |

## APRILIA

|   |       |       |         |         |  |  |       |         |         |  |
|---|-------|-------|---------|---------|--|--|-------|---------|---------|--|
| Amico (All models)  | 96-98 | FA193 | FA193HH | MD904D  |  |  | 893   |         |         |  |
| Europa 50   | 90-92 | FA47  | FA47HH  | MD625LS |  |  | FA60  |         | N/A     |  |
| Area 51   | 98-02 | FA193 | FA193HH | MD936D  |  |  | FA193 | FA193HH | MD943D  |  |
| SR (All models with Drum Rear)                                | 97-02 | FA193 | FA193HH | MD943D  |  |  | 893   |         |         |  |
| SR 50 All models with rear disc                               | 97-99 | FA193 | FA193HH | MD943D  |  |  | FA193 | FA193HH | MD943D  |  |
| SR 50 (All models with rear disc inc Diatech) (Aprilia motor) | 00-07 | FA193 | FA193HH | MD943D  |  |  | FA298 |         | MD943D  |  |
| SR 50 Diatech (Piaggio Motor)                                 | 03-06 | FA193 | FA193HH | MD943D  |  |  | FA298 |         | MD996D  |  |
| Sonic (All models)  | 98-07 | FA193 | FA193HH | MD935D  |  |  | 893   |         |         |  |
| Rally (All models) A/C  | 95-02 | FA193 | FA193HH | MD943D  |  |  | 893   |         |         |  |
| Rally 50 All models L/C                                       | 96-00 | FA193 | FA193HH | MD943D  |  |  | FA193 | FA193HH | MD943D  |  |
| Gulliver (All models)   | 95-98 | FA193 | FA193HH | MD943D  |  |  | 893   |         |         |  |
| Scarabeo 50 (Drum Models)                                     | 93-97 | 805   |         |         |  |  | 893   |         |         |  |
| Scarabeo 50 (All models drum rear)                            | 93-97 | FA193 | FA193HH | MD917D  |  |  | 893   |         |         |  |
| Scarabeo 50 (All models with rear disc)                       | 98-03 | FA193 | FA193HH | MD945D  |  |  | FA193 | FA193HH | MD943D  |  |
| Scarabeo 50 (Rear drum models) (2T)                           | 98-07 | FA193 | FA193HH | MD945D  |  |  | 893   |         |         |  |
| Classic 50  | 92-01 | FA47  | FA47HH  | N/A     |  |  | 995   |         |         |  |
| AF1 Futura 50   | 90-92 | FA47  | FA47HH  | MD625LS |  |  | FA60  |         | N/A     |  |
| RS 50 (6 bolt disc fixing)                                    | 93-98 | FA47  | FA47HH  | MD639LS |  |  | FA60  |         | N/A     |  |
| RS 50 (5 bolt fixing)   | 99-06 | FA194 | FA194HH | MD672LS |  |  | FA60  |         | MD664   |  |
| RS 50 (Radial Caliper)  | 07    | FA266 | FA266HH | MD685LS |  |  | FA115 | FA115HH | MD686   |  |
| Mini RX 50 Experience   | 04    | FA351 |         | N/A     |  |  | TBA   |         |         |  |
| Mini RX 50 Challenge/Entry                                    | 04    | TBA   |         |         |  |  | TBA   |         |         |  |
| MX 50   | 03-05 | FA194 | FA194HH | MD6214D |  |  | FA60  |         | MD6286D |  |
| Mojito/Mojito Custom 50                                       | 03-07 | FA193 | FA193HH | MD943D  |  |  | 817   |         |         |  |
| Quad 50 cc (2 stroke)   | 04    | TBA*  |         |         |  |  | TBA   |         |         |  |
| RX 50 C/CD  | 95-04 | FA194 | FA194HH | MD6214D |  |  | FA60  |         | MD6286D |  |
| RX 50 Racing  | 03-06 | FA194 | FA194HH | TBA     |  |  | FA60  |         | MD6286D |  |
| RX 50   | 06-07 | FA167 | FA167HH | TBA     |  |  | FA115 | FA115HH | TBA     |  |
| Habana 50/Habana Custom                                       | 99-02 | FA193 | FA193HH | MD943D  |  |  | 817   |         |         |  |
| Scarabeo 50 (4 stroke)  | 02-03 | FA193 | FA193HH | MD945D  |  |  | 816   |         |         |  |
| Scarabeo 50 (Di-tech)   | 01-04 | FA193 | FA193HH | MD945D  |  |  | FA298 |         | MD943D  |  |
| Scarabeo 50 (4 Stroke Piaggio Motor)                          | 02-07 | FA193 | FA193HH | MD945D  |  |  | 816   |         |         |  |

\*-2 Sets Required. ■ - Also available in MX-S race compound, see page 8. ✖ - Oversize and Supermoto disc available - see page 301.

**SAFETY WARNING-** DO NOT USE HH PADS ON REAR UNLESS ALSO USED ON FRONT TO AVOID BRAKE IMBALANCE.

**R** Suffix = High Durability Sintered Pad. **HH** Suffix = High Performance Sintered Pad. **G** Suffix = Grooved Shoe.  
**D** Suffix = Drilled Disc. **C** Suffix = Contoured Disc. **LS** Suffix = Left/Steel Disc. **RS** = Right/Steel Disc.

**BRAKE APPLICATIONS**

# Non-Japanese Built Motorcycles/Quads



APPLICATIONS  
BRAKE

R Suffix = High Durability Sintered Pad. HH Suffix = High Performance Sintered Pad. G Suffix = Grooved Shoe.

D Suffix = Drilled Disc. C Suffix = Contoured Disc. LS Suffix = Left/Steel Disc. RS = Right/Steel Disc.

## APRILIA contd.

|                            |       | Front/Avant/Vorn                   |                                    |                   | Frente/Anteriore    |  | Rear/Arrière/Hinten                |                                    |                               | Posterior/Posteriore          |  |
|----------------------------|-------|------------------------------------|------------------------------------|-------------------|---------------------|--|------------------------------------|------------------------------------|-------------------------------|-------------------------------|--|
|                            |       | 1                                  | 2                                  | 3                 | 4                   | 5  | 6                                  | 7                                  | 8                             | 9                             |  |
|                            |       | Sintered/HH Pads/<br>Grooved shoes | Sintered/HH Pads/<br>Grooved shoes | Left/Gauche/Links | Right/Droite/Rechts | Contour Rotor<br>Universal left and<br>right fitment | Sintered/HH Pads/<br>Grooved shoes | Sintered/HH Pads/<br>Grooved shoes | Contour Rotor<br>Rear fitment | Contour Rotor<br>Rear fitment |  |
| SX 50                      | 06-07 | FA167                              | FA167HH                            | TBA               |                     |  | FA115                              | FA115HH                            | TBA                           |                               |  |
| Tuono 50                   | 04    | FA194                              | FA194HH                            | MD672LS           |                     |  | FA60                               |                                    | MD664                         |                               |  |
| Quad 100cc (2 stroke)      | 04    | TBA*                               |                                    |                   |                     |  | TBA                                |                                    |                               |                               |  |
| Scarabeo 100 (2 stroke)    | 00-02 | FA301                              |                                    | MD945D            |                     |  | Y527                               |                                    |                               |                               |  |
| Scarabeo 100 (4 stroke)    | 02-07 | FA193                              | FA193HH                            | MD945D            |                     |  | 816                                |                                    |                               |                               |  |
| AF1 125                    | 87    | FA134                              |                                    |                   | MD635RS             |  | FA47                               |                                    | MD658                         |                               |  |
| AF1 125                    | 88-89 | FA126                              | FA126HH                            |                   | MD635RS             |  | FA47                               | FA47HH                             | MD658                         |                               |  |
| AF1 125                    | 90-91 | FA126                              | FA126HH                            |                   | MD612RS             |  | FA47                               | FA47HH                             | MD658                         |                               |  |
| Atlantic 125/200/250       | 03-06 | FA324                              |                                    | MD997D            |                     |  | FA298                              |                                    | MD996D                        |                               |  |
| Atlantic 125               | 07    | FA324                              |                                    | MD997D            |                     |  |                                    |                                    | MD996D                        |                               |  |
| Classic 125                | 95-01 | FA256                              | FA256HH                            |                   | MD628RS             |  | 921                                |                                    |                               |                               |  |
| ETX 125                    | 99-01 | FA194                              | FA194HH                            | N/A               |                     |  | FA173                              |                                    | N/A                           |                               |  |
| Habana 125/Habana Custom   | 00-02 | FA301                              |                                    | MD943D            |                     |  | 816                                |                                    |                               |                               |  |
| Leonardo 125/150           | 96-98 | FA193                              | FA193HH                            | MD942D            |                     |  | FA193                              | FA193HH                            | MD943D                        |                               |  |
| Leonardo 125/150 ST/SP     | 99-04 | FA301                              |                                    | MD942D            |                     |  | FA301                              |                                    | MD943D                        |                               |  |
| Leonardo 125               | 05-06 | FA301                              |                                    | MD942D            |                     |  | FA301                              |                                    | MD990D                        |                               |  |
| Mojito/Mojito Custom 125   | 03-06 | FA301                              |                                    | MD943D            |                     |  | 816                                |                                    |                               |                               |  |
| MX 125                     | 04-06 | FA181TT                            | FA181R                             | MD2003LS          |                     |  | FA382                              |                                    | TBA                           |                               |  |
| RS 125                     | 92-98 | FA126                              | FA126HH                            |                   | MD2003RS            | MD2003C  | FA47                               | FA47HH                             | MD659                         |                               |  |
| RS 125                     | 99-05 | FA126                              | FA126HH                            |                   | MD2003RS            | MD2003C  | FA47                               | FA47HH                             | MD664                         |                               |  |
| RS 125 (Radial Caliper)    | 06-07 | FA432                              | FA432HH                            |                   | MD621RS             | MD621C   | FA298                              |                                    | MD664                         |                               |  |
| Scarabeo 125/150           | 99-02 | FA256                              | FA256HH                            | MD952D            |                     |  | FA298                              |                                    | MD942D                        |                               |  |
| Scarabeo 125/200           | 03    | FA256                              | FA256HH                            | MD952D            |                     |  | FA298                              |                                    | MD942D                        |                               |  |
| Scarabeo 125/150 GT        | 04-06 | FA324                              |                                    | MD952D            |                     |  | FA298                              |                                    | MD942D                        |                               |  |
| Scarabeo 125               | 07    | FA324                              |                                    | MD952D            |                     |  | FA298                              |                                    | TBA                           |                               |  |
| Sport City 125/200         | 04-06 | FA256                              | FA256HH                            | MD952D            |                     |  | FA298                              |                                    | MD942D                        |                               |  |
| Tuareg Rally 125 (N)       | -93   | FA167                              | FA167HH                            |                   | N/A                 |  | FA382                              |                                    | N/A                           |                               |  |
| RX 125                     | 92-99 | FA194                              | FA194HH                            |                   | N/A                 |  | FA382                              |                                    | N/A                           |                               |  |
| RX 125                     | 00-01 | FA181TT                            | FA181R                             | N/A               |                     |  | FA382                              |                                    | N/A                           |                               |  |
| Pegaso 125                 | 91    | FA167                              | FA167HH                            |                   | N/A                 |  | FA382                              |                                    | N/A                           |                               |  |
| Pegaso 125 "Kat"           | 94-95 | FA194                              | FA194HH                            |                   | N/A                 |  | FA382                              |                                    | N/A                           |                               |  |
| Red Rose 125 (Cast wheel)  | 87    | FA256                              | FA256HH                            | N/A               |                     |  | FA47                               | FA47HH                             |                               |                               |  |
| Red Rose 125 (Spoke wheel) | 88-94 | FA256                              | FA256HH                            |                   | MD628RS             |  | 921                                |                                    |                               |                               |  |
| SR 125/150                 | 99-02 | FA301                              |                                    | MD943D            |                     |  | 816                                |                                    |                               |                               |  |
| Tuareg Rally 125           | 89    | FA163                              |                                    | N/A               |                     |  | FA382                              |                                    | N/A                           |                               |  |
| Tuareg Rally 125 (LM)      | 90-91 | FA256TT                            | FA256HH                            | N/A               |                     |  | FA382                              |                                    | N/A                           |                               |  |
| Tuono 125                  | 03-04 | FA126                              | FA126HH                            |                   | MD2003RS            | MD2003C  | FA47                               | FA47HH                             | MD664                         |                               |  |
| TX 125/240/311             | 86-88 | FA115                              | FA115R                             |                   | N/A                 |  |                                    | 841G                               |                               |                               |  |
| Quad 180 Sport (4 stroke)  | 04    | TBA*                               |                                    |                   |                     |  | TBA                                |                                    | TBA                           |                               |  |
| Quad 180 Grip (4 stroke)   | 04    | TBA*                               |                                    |                   |                     |  | TBA                                |                                    | TBA                           |                               |  |
| Scarabeo 200               | 07    | FA324                              |                                    | MD952D            |                     |  | FA298                              |                                    | TBA                           |                               |  |
| TRX 240 M                  | 89    | FA99                               | FA99R                              |                   | N/A                 |  | FA99                               | FA99R                              | N/A                           |                               |  |
| 250                        | 86    | FA47                               | FA47R                              |                   | N/A                 |  |                                    | 841G                               |                               |                               |  |
| Atlantic 250 ie            | 07    | FA324                              |                                    | MD997D            |                     |  |                                    |                                    | MD996D                        |                               |  |
| Leonardo 250 SP/ST Models  | 00-04 | FA256                              | FA256HH                            | MD942D            |                     |  | FA298                              |                                    | MD990D                        |                               |  |
| RS 250                     | 95-97 | FA95*                              | FA95HH*                            | MD660LS           | MD660RS             |  | FA47                               | FA47HH                             | MD665                         |                               |  |
| RS 250                     | 98-02 | FA244*                             | FA244HH*                           | MD660LS           | MD660RS             |  | FA47                               | FA47HH                             | MD665                         |                               |  |
| Scarabeo 250 ie            | 07    | FA324                              |                                    |                   |                     |  | FA298                              |                                    | TBA                           |                               |  |
| Sport City 250             | 06    | TBA                                |                                    | TBA               | TBA                 |  | TBA                                |                                    | TBA                           |                               |  |
| Sport City 250 ie          | 07    | FA256*                             | FA256HH*                           | MD952D            | MD952D              |  | FA298                              |                                    | TBA                           |                               |  |
| 280 R Climber              | 92-93 | FA115                              | FA115R                             |                   | N/A                 |  | FA337TT                            | FA337R                             | N/A                           |                               |  |
| 280 Climber                | 94-96 | FA115                              | FA115R                             |                   | N/A                 |  | FA156                              |                                    | N/A                           |                               |  |
| Scarabeo 250               | 06    | FA324                              | FA324HH                            | MD952D            |                     |  | FA298                              |                                    | MD942D                        |                               |  |
| Leonardo 300               | 05-06 | FA256                              | FA256HH                            | MD942D            |                     |  | FA298                              |                                    | MD990D                        |                               |  |
| TX 311                     | 88    | FA115                              | FA115R                             |                   | N/A                 |  | FA115                              | FA115R                             | N/A                           |                               |  |
| RX 3-5 Marce (M/N)         | 91-92 | FA167                              | FA167HH                            | MD6214D           |                     |  | FA60                               |                                    | MD6286D                       |                               |  |
| RX 3-5 Marce (P/R)         | 93-94 | FA167                              | FA167HH                            | MD6214D           |                     |  | FA60                               |                                    | MD6286D                       |                               |  |
| Atlantic 400 Sprint        | 07    | FA324                              |                                    | MD952             |                     |  | FA298                              |                                    | TBA                           |                               |  |
| Scarabeo 400 ie            | 07    | FA256*                             | FA256HH*                           | MD952D            | MD952D              |  | FA298                              |                                    | TBA                           |                               |  |
| MXV 450 Magura Calipers    | 07    | FA433/4*                           | FA433/4HH*                         | TBA               |                     |  | TBA                                |                                    | TBA                           |                               |  |

\*-2 Sets Required. ■ - Also available in MX-S race compound, see page 8. ✖ - Oversize and Supermoto disc available - see page 301.

**SAFETY WARNING- DO NOT USE HH PADS ON REAR UNLESS ALSO USED ON FRONT TO AVOID BRAKE IMBALANCE.**



# Non-Japanese Built Motorcycles/Quads



## APRILIA contd.

|   |       | Front/Avant/Vorn                   |                   |                     | Frente/Anteriore                                     |          | Rear/Arrière/Hinten                |         |                               | Posterior/Posteriore |  |
|---|-------|------------------------------------|-------------------|---------------------|--|----------|------------------------------------|---------|-------------------------------|----------------------|--|
|   |       | 1                                  | 2                 | 3                   | 4  | 5        | 6                                  | 7       | 8                             | 9                    |  |
|   |       | Sintered/HH Pads/<br>Grooved shoes | Left/Gauche/Links | Right/Droite/Rechts | Contour Rotor<br>Universal left and<br>right fitment |          | Sintered/HH Pads/<br>Grooved shoes |         | Contour Rotor<br>Rear fitment |                      |  |
| RXV 450/550 Enduro                          | 06-07 | FA185TT                            | FA185R■           | TBA                 |  |          | FA367TT                            | FA367R■ | TBA                           |                      |  |
| SVX 450/550 Supermoto                       | 06-07 |                                    | MXS405            | TBA                 |  |          | FA367TT                            | FA367R■ | TBA                           |                      |  |
| SXV 450                                     | 07    |                                    | FA218HH           | TBA                 |  |          | FA367TT                            | FA367R■ | TBA                           |                      |  |
| Atlantic 500                                | 02-04 | FA256*                             | FA256HH*          | MD952D              | MD952D   |          | FA298                              |         | MD990D                        |                      |  |
| Atlantic 500 Sprint                         | 05-06 | FA324                              |                   | TBA                 |  |          | FA298                              |         | MD990D                        |                      |  |
| Atlantic 500 Sprint                         | 07    | FA324                              |                   | MD952D              |  |          | FA298                              |         | TBA                           |                      |  |
| Scarabeo 500/500 ABS                        | 03-06 | FA256*                             | FA256HH*          | MD952D              | MD952D   |          | FA298                              |         | MD990D                        |                      |  |
| Scarabeo 500 Light                          | 06    | FA256*                             | FA256HH*          | MD952D              | MD952D   |          | FA298                              |         | TBA                           |                      |  |
| Scarabeo 500 ie                             | 07    | FA256*                             | FA256HH*          | MD952D              | MD952D   |          | FA298                              |         | TBA                           |                      |  |
| SXV 549                                     | 07    |                                    | FA218HH           | TBA                 |  |          | FA367TT                            | FA367R■ | TBA                           |                      |  |
| Pegaso 600                                  | 91    | FA167                              | FA167HH           |                     | N/A  |          | FA382                              |         | N/A                           |                      |  |
| Tuareg Wind 600                             | 89    | FA163                              |                   | MD6180D             |  |          | FA382                              |         | N/A                           |                      |  |
| Pegaso 650                                  | 91-96 | FA177                              |                   | MD6129D             |  |          | FA173                              |         | MD6128D                       |                      |  |
| Pegaso 650                                  | 97-00 | FA209/2                            | FA209/2HH         | MD6129D             |  |          | FA173                              |         | MD6128D                       |                      |  |
| Pegaso 650 ie                               | 01-04 | FA209/2                            | FA209/2HH         | MD6129D             |  |          | FA208TT                            | FA208R  | MD651                         |                      |  |
| Pegaso Strada 650                           | 05-06 | FA244                              | FA244HH           | MD621LS             |  |          | FA213                              | FA213HH | MD651                         |                      |  |
| Pegaso 650 Trial                            | 06-07 | FA209/2                            | FA209/2HH         | MD6129D             |  |          | FA213                              | FA213HH | MD651                         |                      |  |
| Pegaso 650 Factory                          | 07    | FA244                              | FA244HH           | MD621LS             |  | MD621C   | FA213                              | FA213HH | TBA                           |                      |  |
| Pegaso 650                                  | 07    | FA244                              | FA244HH           | MD621LS             |  | MD621C   | FA213                              | FA213HH | TBA                           |                      |  |
| Moto 6.5                                    | 95-01 | FA209/2                            | FA209/2HH         | MD673LS             |  |          | FA173                              |         | MD674                         |                      |  |
| SL 750 Shiver                               | 07    | FA432*                             | FA432HH*          | MD621LS             | MD621RS  | MD621C*  | FA213                              | FA213HH | TBA                           |                      |  |
| NA 850 Mana                                 | 07    | FA432*                             | FA432HH*          | MD621LA             | MD621RS  | MD621C*  | FA213                              | FA213HH | TBA                           |                      |  |
| ETV 1000 "Caponord/RaidABS"                 | 01-07 | FA209/2*                           | FA209/2HH*        | TBA                 | TBA  |          | FA266                              | FA266HH | TBA                           |                      |  |
| RST Futura 1000                             | 01-04 | FA244*                             | FA244HH*          | MD2001LS            | MD2001RS   | MD2001C* | FA245                              | FA245HH | TBA                           |                      |  |
| RSV 1000 Mille SP                           | 99    | FA244*                             | FA244HH*          | MD666LS             | MD666RS  | MD666C*  | FA266                              | FA266HH | MD613                         | MD613C               |  |
| RSV 1000 All models                         | 98-99 | FA244*                             | FA244HH*          | MD666LS             | MD666RS  | MD666C*  | FA266                              | FA266HH | MD613                         | MD613C               |  |
| RSV 1000 Mille /Mille R                     | 00    | FA244*                             | FA244HH*          | MD666LS             | MD666RS  | MD666C*  | FA266                              | FA266HH | MD613                         | MD613C               |  |
| RSV Mille/Mille R                           | 01-04 |                                    | FA322/4HH*        | MD621LS             | MD621RS  | MD621C*  | FA266                              | FA266HH | MD613                         | MD613C               |  |
| RSV 1000 (Radial mount calipers) All models | 03-07 |                                    | FA322/4HH*        | MD621LS             | MD621RS  | MD621C*  | FA266                              | FA266HH | MD613                         | MD613C               |  |
| SL 1000 "Falco"                             | 00-04 | FA244*                             | FA244HH*          | MD666LS             | MD666RS  | MD666C*  | FA266                              | FA266HH | MD613                         | MD613C               |  |
| 1000 Tuono (Standard Caliper)               | 02-05 | FA244*                             | FA244HH*          | MD621LS             | MD621RS  | MD621C*  | FA266                              | FA266HH | MD613                         | MD613C               |  |
| Tuono 1000 (Radial Caliper)                 | 02-07 |                                    | FA322/4HH*        | MD621LS             | MD621RS  | MD621C*  | FA266                              | FA266HH | MD613                         | MD613C               |  |

## ARMSTRONG

|                     |  |  |      |  |  |  |  |      |  |  |
|---------------------|--|--|------|--|--|--|--|------|--|--|
| 250 Trial/320 Trial |  |  | 841G |  |  |  |  | 841G |  |  |
|---------------------|--|--|------|--|--|--|--|------|--|--|

## ASPES

|                            |  |      |       |     |  |  |     |       |  |  |
|----------------------------|--|------|-------|-----|--|--|-----|-------|--|--|
| 50 Navaho                  |  |      | 926WG |     |  |  |     | 926WG |  |  |
| CS 75 Navaho/125 Juma/Hopi |  |      | 841WG |     |  |  |     | 843WG |  |  |
| CM1 80                     |  |      | 841WG |     |  |  |     | 841WG |  |  |
| RCL 80                     |  | 941  |       |     |  |  | 941 |       |  |  |
| 125 Duma                   |  | FA76 |       | N/A |  |  | 843 |       |  |  |

## ATALA

|               |    |       |         |        |  |  |      |  |  |  |
|---------------|----|-------|---------|--------|--|--|------|--|--|--|
| Hacker LC     | 97 | FA193 | FA193HH | MD901D |  |  | S624 |  |  |  |
| Hacker Racing | 97 | FA193 | FA193HH | MD901D |  |  | S624 |  |  |  |
| Byte "AT10"   | 97 | FA193 | FA193HH | TBA    |  |  | S624 |  |  |  |
| Hacker        | 97 | FA193 | FA193HH | MD901D |  |  | S624 |  |  |  |

## BAOTAIN

|             |       |     |  |     |     |  |     |  |     |  |
|-------------|-------|-----|--|-----|-----|--|-----|--|-----|--|
| BT 49 QT-7  | 06-07 | TBA |  | TBA |     |  | TBA |  | TBA |  |
| BT 49 QT-12 | 06-07 | TBA |  | TBA |     |  | TBA |  |     |  |
| BT 50 QT-9N | 06-07 | TBA |  | TBA |     |  | TBA |  |     |  |
| BT 50 QT-11 | 06-07 | TBA |  | TBA |     |  | TBA |  |     |  |
| BT 110-2    | 06-07 | TBA |  |     | N/A |  | TBA |  |     |  |
| BT 125 T-2  | 06-07 | TBA |  | TBA |     |  | TBA |  | N/A |  |
| BT 125 T-7  | 06-07 | TBA |  |     | N/A |  | TBA |  | N/A |  |

\*-2 Sets Required. ■ - Also available in MX-S race compound, see page 8. ✖ - Oversize and Supermoto disc available - see page 301.

**SAFETY WARNING-** DO NOT USE HH PADS ON REAR UNLESS ALSO USED ON FRONT TO AVOID BRAKE IMBALANCE.

R Suffix = High Durability Sintered Pad. HH Suffix = High Performance Sintered Pad. G Suffix = Grooved Shoe.  
D Suffix = Drilled Disc. C Suffix = Contoured Disc. LS Suffix = Left/Steel Disc. RS = Right/Steel Disc.

BRAKE  
APPLICATIONS

# Non-Japanese Built Motorcycles/Quads



Front/Avant/Vorn



Frente/Anteriore

Rear/Arrière/Hinten



Posterior/Posteriore

1

2

3

4

5

6

7

8

9

## BAROSSA QUADS

|                   |       | 1                                  | 2                                  | 3                 | 4                   | 5  | 6                                  | 7                                  | 8                             | 9 |
|-------------------|-------|------------------------------------|------------------------------------|-------------------|---------------------|--|------------------------------------|------------------------------------|-------------------------------|---|
|                   |       | Sintered/HH Pads/<br>Grooved shoes | Sintered/HH Pads/<br>Grooved shoes | Left/Gauche/Links | Right/Droite/Rechts | Contour Rotor<br>Universal left and<br>right fitment | Sintered/HH Pads/<br>Grooved shoes | Sintered/HH Pads/<br>Grooved shoes | Contour Rotor<br>Rear fitment |   |
| Mini 50/Python    | 03-05 | TBA                                |                                    |                   |                     |  | TBA                                |                                    |                               |   |
| 100 Sport/Python  | 03-05 | TBA*                               |                                    |                   |                     |  | TBA                                |                                    |                               |   |
| 170 Sport         | 03-04 | TBA*                               |                                    |                   |                     |  | FA135TT                            | FA135R                             | N/A                           |   |
| 170 Cheetah/Magna | 03-05 | TBA*                               |                                    |                   |                     |  | FA135TT                            | FA135R                             | N/A                           |   |
| 170 Cheetah       | 03-06 | Y503*                              | Y503G*                             |                   |                     |  | FA67TT                             | FA67R                              | N/A                           |   |
| 250 Cheetah       | 03-06 | Y503*                              | Y503G*                             |                   |                     |  | FA67TT                             | FA67R                              | N/A                           |   |
| Quarterback 250   | 05    | TBA*                               |                                    |                   |                     |  | FA135TT                            | FA135R                             | N/A                           |   |

## BENELLI

|   |       |         |            |         |         |         |         |         |         |         |
|---|-------|---------|------------|---------|---------|---------|---------|---------|---------|---------|
| 49X Scooter                                     | 07    | FA235   |            | TBA     |         |         | TBA     |         |         |         |
| Motorella                                       | 78-   | 908     |            |         |         |         | 908     |         |         |         |
| 50 G2 Elle                                      | 79-   | 931     |            |         |         |         | 931     |         |         |         |
| S 50 Scooter                                    | 81-   | 945     |            |         |         |         | 965     |         |         |         |
| Devil 50  | 92-   | FA126   | FA126R     | N/A     |         |         | FA99    | FA99R   | N/A     |         |
| Spring 50                                       | 93-   | FA126   | FA126R     | N/A     |         |         | FA99    | FA99R   | N/A     |         |
| Naked 50  | 02-03 | FA193   | FA193HH    | MD909D  |         |         | 893     |         |         |         |
| Pepe 50/50 LX                                   | 99-07 | FA193   | FA193HH    | MD956D  |         |         | 893     |         |         |         |
| Devil 80  | 92-   | FA126   | FA126R     | N/A     |         |         | FA99    | FA99R   | N/A     |         |
| 491 (All drum rear models) 50cc                 | 98-04 | FA193   | FA193HH    | MD909D  |         |         | 893     |         |         |         |
| 491 (All rear disc models) 50cc                 | 99-04 | FA193   | FA193HH    | MD909D  |         |         | FA193   | FA193HH | MD909D  |         |
| K2 "50"   | 98-01 | FA193   | FA193HH    | MD909D  |         |         | 893     |         |         |         |
| K2 "100"  | 99-01 | FA193   | FA193HH    | MD909D  |         |         | Y527    |         |         |         |
| Naked 100                                       | 02    | FA193   | FA193HH    | MD909D  |         |         | 893     |         |         |         |
| Pepe 100 LX                                     | 99-06 | FA193   | FA193HH    | TBA     |         |         | 893     |         |         |         |
| 125 T   | 83    | FA47    | FA47HH     | N/A     |         |         | 929     |         |         |         |
| 124/125 2C/126 2T/2CSE                          | 76-   | FA47    | FA47R      | N/A     |         |         | 929     |         |         |         |
| 125 2C twin brake                               | -76   | 946     |            |         |         |         | 929     |         |         |         |
| Tarno 125                                       | 89-   | FA126   | FA126R     | N/A     |         |         | N/A     |         |         |         |
| Adiva 125/150 (12" front wheel/rear drum model) | 00    | FA193   | FA193HH    | MD924D  |         |         | 816     |         |         |         |
| Adiva 125/150 (13" front wheel/rear disc model) | 01-04 | FA193   | FA193HH    | MD9101D |         |         | FA321   |         | MD9106D |         |
| Velvet 125/150 (13" front wheel)                | 99-07 | FA193   | FA193HH    | MD9101D |         |         | FA193   | FA193HH | MD966D  |         |
| Velvet 250                                      | 99-07 | FA194   | FA194HH    | MD997D  |         |         | FA298   |         | MD966D  |         |
| 250 C/TS, 250/4                                 | 76-   | FA47    | FA47HH     | N/A     |         |         | 929     |         |         |         |
| 666 Scooter "Born in Hell" 125cc                | 98-99 | FA95    | FA95HH     | N/A     |         |         | FA47    | FA47HH  | TBA     |         |
| 254   | 83    | N/A     |            | N/A     |         |         | 929     |         |         |         |
| 304   | 83    | FA47    | FA47HH     | N/A     |         |         | 929     |         |         |         |
| 354   | -82   | FA47*   | FA47HH*    | N/A     | N/A     |         | FA18    | FA18HH  |         |         |
| 354 Sport 2                                     | 83    | FA47*   | FA47HH*    | N/A     | N/A     |         | FA47    | FA47HH  | N/A     |         |
| Velvet 400 Dusk                                 | 03-04 | FA194   | FA194HH    | TBA     |         |         | FA298   |         | TBA     |         |
| BX 450  | 07    | FA181TT | FA181TT    |         |         | MD6032C | FA208TT | FA208R  |         | MD6035C |
| 500 -4  | 76-   | FA47*   | FA47HH*    | N/A     | N/A     |         | 929     |         |         |         |
| 654 Sport                                       | 83    | FA47*   | FA47HH*    | N/A     | N/A     |         | FA47    | FA47HH  | N/A     |         |
| 750 SEi (6 Cyl)                                 | 75-   | FA18*   | FA18HH*    | N/A     | N/A     |         | N/A     |         |         |         |
| 2-UE (750cc)                                    | 07    |         | FA322/4HH* | MD614LS | MD614RS | MD614C* | FA266   | FA266HH | N/A     |         |
| TNT 899 Tornado Naked Tre                       | 07    | FA244*  | FA244HH*   | MD621LS | MD621RS | MD621C* | FA266   | FA266HH | TBA     |         |
| Trek 899  | 07    | FA244   | FA244HH    | MD614LS | MD614RS | MD614C* | FA266   | FA266HH | TBA     |         |
| 900 SEi (6 Cyl)                                 | 83    | FA18*   | FA18HH*    | N/A     | N/A     |         | FA77    |         | N/A     |         |
| Tornado 900                                     | 02    | FA244*  | FA244HH*   | TBA     | TBA     |         | FA266   | FA266HH | TBA     |         |
| Tornado Tre Novecento/LE/RS                     | 03-05 |         | FA322/4HH* | MD636LS | MD636RS |         | FA266   | FA266HH | TBA     |         |
| TNT 1130 Cafe Racer                             | 05    | FA244*  | FA244HH*   | MD633LS | MD633RS | MD633C* | FA266   | FA266HH | MD651D  |         |
| TNT 1130 Cafe Racer                             | 06-07 |         | FA322/4HH* | MD621LS | MD621RS | MD621C  | FA266   | FA266HH | MD651D  |         |
| TNT 1130 Sport/Sport Evo                        | 04-07 |         | FA322/4HH* | MD633LS | MD633RS | MD633C* | FA266   | FA266HH | MD651D  |         |
| TNT 1130 Titanium                               | 05    | FA244*  | FA244HH*   | MD633LS | MD633RS | MD633C* | FA266   | FA266HH | MD651D  |         |
| TNT 1130 Titanium                               | 06    |         | FA322/4HH* | MD621LS | MD621RS | MD621C  | FA266   | FA266HH | MD651D  |         |
| Tornado TRE 1130 (Radial caliper)               | 06-07 |         | FA322/4HH* | MD621LS | MD621RS | MD621C  | FA266   | FA266HH | MD651D  |         |
| Tornado Naked Tre TNT 1130                      | 06-07 | FA244*  | FA244HH*   | MD621LS | MD621RS | MD621C  | FA266   | FA266HH | MD651D  |         |
| Tornado Tre 1130                                | 06    |         | FA322/4HH* | MD621LS | MD621RS |         | FA266   | FA266HH | TBA     |         |
| TRE-K 1130                                      | 06-07 | FA244*  | FA244HH*   | MD614LS | MD614RS | MD614C  | FA266   | FA266HH | TBA     |         |
| Trek 1130 Amazonas                              | 07    | FA244*  | FA244HH*   | TBA     | TBA     |         | FA266   | FA266HH | TBA     |         |

\*-2 Sets Required. ■ - Also available in MX-S race compound, see page 8. ✖ - Oversize and Supermoto disc available - see page 301.

**SAFETY WARNING-** DO NOT USE HH PADS ON REAR UNLESS ALSO USED ON FRONT TO AVOID BRAKE IMBALANCE.

# Non-Japanese Built Motorcycles/Quads



## BETA

|                                   |        | Front/Avant/Vorn                   |                                    |                   | Frente/Anteriore    |  | Rear/Arrière/Hinten                |                                    |        | Posterior/Posteriore          |  |
|-----------------------------------|--------|------------------------------------|------------------------------------|-------------------|---------------------|--|------------------------------------|------------------------------------|--------|-------------------------------|--|
|                                   |        | 1                                  | 2                                  | 3                 | 4                   | 5  | 6                                  | 7                                  | 8      | 9                             |  |
|                                   |        | Sintered/HH Pads/<br>Grooved shoes | Sintered/HH Pads/<br>Grooved shoes | Left/Gauche/Links | Right/Droite/Rechts | Contour Rotor<br>Universal left and<br>right fitment | Sintered/HH Pads/<br>Grooved shoes | Sintered/HH Pads/<br>Grooved shoes |        | Contour Rotor<br>Rear fitment |  |
| Minicross Pro Race 12/10          | 04-06  | FA351                              |                                    | N/A               |                     |  | FA351                              |                                    | N/A    |                               |  |
| Rev 50/80                         | 00-07  | FA115TT                            | FA115R                             | N/A               |                     |  | FA115TT                            | FA115R                             | N/A    |                               |  |
| ARK (Air Cooled Models)           | 96-07  | FA193                              | FA193HH                            | MD901D            |                     |  | 893                                |                                    |        |                               |  |
| ARK (LC Models)                   | 97-07  | FA193                              | FA193HH                            | MD901D            |                     |  | FA193                              | FA193HH                            | MD901D |                               |  |
| Pro Race 50                       | 05     | FA115                              | FA115HH                            | N/A               |                     |  | FA351                              |                                    |        |                               |  |
| Quadra 50                         | 97-01  | FA193                              | FA193HH                            | MD901D            |                     |  | 893                                |                                    |        |                               |  |
| 50 RR Supermoto/Enduro            | 99-05  | FA115                              | FA115HH                            | N/A               |                     |  | FA115                              | FA115HH                            | N/A    |                               |  |
| RR 'Enduro Alu'/Motard Alu        | 03-    | FA303                              |                                    |                   | N/A                 |  | FA291                              |                                    | N/A    |                               |  |
| RR Enduro Alu 50/Motard Alu 50    | 04-07  | FA167                              | FA167HH                            | N/A               |                     |  | FA115                              | FA115HH                            | N/A    |                               |  |
| RR Enduro 50                      | 04-07  | FA167                              | FA167HH                            | N/A               |                     |  | FA115                              | FA115HH                            | N/A    |                               |  |
| RK6                               | 93-96  | FA167                              | FA167HH                            | MD6296D           |                     |  | FA116                              |                                    | N/A    |                               |  |
| Tempo 16                          | 94-97  | FA116                              |                                    | N/A               |                     |  | 893                                |                                    |        |                               |  |
| Eickon 50                         | 99-06  | FA115                              | FA115HH                            | MD901D            |                     |  | FA115                              | FA115HH                            | MD901D |                               |  |
| RK6 50cc Enduro                   | 97-02  | FA167                              | FA167HH                            | N/A               |                     |  | FA115                              | FA115HH                            | N/A    |                               |  |
| Tempo 50                          | 98-02  | FA193                              | FA193HH                            | MD901D            |                     |  | 893                                |                                    |        |                               |  |
| 124 TR                            | 80-83  |                                    | 841G                               |                   |                     |  |                                    | 841G                               |        |                               |  |
| Alp 125/200                       | 05-07  | FA194                              | FA194HH                            | N/A               |                     |  | FA131TT                            |                                    | N/A    |                               |  |
| Rev 3 125/200                     | 00-05  | FA303                              | N/A                                | N/A               |                     |  | FA303                              | N/A                                | N/A    |                               |  |
| Rev 3 125/200                     | 06     | FA303                              |                                    | N/A               |                     |  | FA403                              |                                    | N/A    |                               |  |
| TR 125                            | 80-83  |                                    | 841G                               |                   |                     |  |                                    | 841G                               |        |                               |  |
| TR 125 32/33                      | 86-87  | FA99                               | FA99R                              | N/A               |                     |  |                                    | 841G                               |        |                               |  |
| 125 TR 34                         | 88     | FA115                              | FA115R                             | N/A               |                     |  | FA116                              | N/A                                | N/A    |                               |  |
| 125 TR 34                         | 89     | FA115                              | FA115R                             | N/A               |                     |  | FA115                              | FA115R                             |        |                               |  |
| Eurotek/Techno 125/250            | 96-98  | FA115                              | FA115R                             | N/A               |                     |  | FA115                              | FA115R                             | N/A    |                               |  |
| Rev 3 250/270                     | 00-04  | FA303                              | N/A                                | N/A               |                     |  | FA303                              | N/A                                | N/A    |                               |  |
| Rev 3 250/270                     | 05-07  | FA303                              | N/A                                | N/A               |                     |  | FA403                              | N/A                                | N/A    |                               |  |
| Eikon 125/150                     | 00-06  | FA47                               | FA47HH                             | MD924D            |                     |  | FA298                              |                                    | MD909D |                               |  |
| Jonathan 125                      | 00-01  | FA95                               | FA95HH                             |                   | N/A                 |  | FA213                              | FA213HH                            | N/A    |                               |  |
| Jonathan 125                      | 02-05  | FA95                               | FA95HH                             |                   | N/A                 |  | FA173                              |                                    | N/A    |                               |  |
| RR 125 (All models)               | 06-07  | FA194                              | FA194HH                            | N/A               |                     |  | FA367TT                            | FA367R                             | N/A    |                               |  |
| Alp 4T (125/200)                  | 00-04  | FA115TT                            | FA115HH                            | N/A               |                     |  | FA115                              | FA115HH                            | N/A    |                               |  |
| Alp 4.0                           | 04     | FA194                              | FA194HH                            | N/A               |                     |  | FA382                              |                                    | N/A    |                               |  |
| Alp 4.0                           | 05-07  | FA194                              | FA194HH                            | N/A               |                     |  | FA131TT                            |                                    | N/A    |                               |  |
| 240 TR                            | 80-83  |                                    | 841G                               |                   |                     |  |                                    | 841G                               |        |                               |  |
| 240 TR 32                         | 84-85  |                                    | 939G                               |                   |                     |  |                                    | 841G                               |        |                               |  |
| 240 TR 33                         | 86     | FA99                               | FA99R                              | N/A               |                     |  |                                    | 841G                               |        |                               |  |
| RR 250/400/450/525 Enduro         | 05-07  | FA185TT                            | FA185R                             | N/A               |                     |  | FA367TT                            | FA367R                             | N/A    |                               |  |
| TR 34                             | 86-88  | FA99                               | FA99R                              | N/A               |                     |  | FA116                              | N/A                                | N/A    |                               |  |
| TR 34                             | 86     | FA99                               | FA99R                              | N/A               |                     |  | FA116                              | N/A                                | N/A    |                               |  |
| TR 34 260                         | 89-91  | FA99                               | FA99R                              | N/A               |                     |  | FA164                              | FA164R                             | N/A    |                               |  |
| SYNT                              | 92     | FA115TT                            | FA115R                             | N/A               |                     |  | FA164                              | FA164R                             | N/A    |                               |  |
| Zero                              | 92     | FA115TT                            | FA115R                             | N/A               |                     |  | FA164                              | FA164R                             | N/A    |                               |  |
| SYNT/GARA                         | 93-95  | FA115TT                            | FA115R                             | N/A               |                     |  | FA156                              | N/A                                | N/A    |                               |  |
| Super Trial ST                    | 94     | FA115TT                            | FA115R                             | N/A               |                     |  | FA164                              | FA164R                             | N/A    |                               |  |
| Techno                            | 95     | FA115TT                            | FA115R                             | N/A               |                     |  | FA156                              | N/A                                | N/A    |                               |  |
| Euro 350                          | 00-01  | FA126                              | FA126HH                            |                   | N/A                 |  | FA213                              | FA213HH                            | N/A    |                               |  |
| Euro 350                          | 02     | FA126                              | FA126HH                            |                   | N/A                 |  | FA173                              |                                    | N/A    |                               |  |
| Euro/Jonathan 350                 | 03-06  | FA95                               | FA95HH                             |                   | N/A                 |  | FA101TT                            |                                    | N/A    |                               |  |
| M4 350 Supermotard                | 04-06  | FA426                              |                                    | N/A               |                     |  | FA337TT                            | FA337R                             | N/A    |                               |  |
| M4 350 Motard                     | 07     | FA426                              |                                    | N/A               |                     |  | FA367TT                            | FA367R                             | N/A    |                               |  |
| <b>BIMOTA</b>                     |        |                                    |                                    |                   |                     |  |                                    |                                    |        |                               |  |
| All early models                  | -88    | FA18*                              | FA18HH*                            | N/A               | N/A                 |  | FA18                               | FA18HH                             | N/A    |                               |  |
| All models (Single pin fixing)    | 89-    | FA95*                              | FA95HH*                            | N/A               | N/A                 |  | FA47                               | FA47HH                             | N/A    |                               |  |
| Or later models (Twin pin fixing) | 98/99- | FA244*                             | FA244HH*                           | N/A               | N/A                 |  | FA47                               | FA47HH                             | N/A    |                               |  |
| Tesi 2D (Ducati) 992cc            | 04-06  | FA95*                              | FA95HH*                            | N/A               | N/A                 |  | FA47                               | FA47HH                             | N/A    |                               |  |
| Elirio                            | 06     |                                    | FA322/4HH*                         | N/A               | N/A                 |  | FA266                              | FA266HH                            | N/A    |                               |  |
| DB5 (All models)                  | 06-07  |                                    | FA322/4HH*                         | N/A               | N/A                 |  | FA266                              | FA266HH                            | N/A    |                               |  |
| DB5R                              | 06-07  |                                    | FA322/4HH*                         | TBA               | TBA                 |  | FA266                              | FA266HH                            | TBA    |                               |  |
| DB6 Delirio (992cc) Ducati engine | 07     |                                    | FA322/4HH*                         | TBA               | TBA                 |  | FA266                              | FA266HH                            | TBA    |                               |  |

\*-2 Sets Required. ■ - Also available in MX-S race compound, see page 8. ✖ - Oversize and Supermoto disc available - see page 301.

**SAFETY WARNING-** DO NOT USE HH PADS ON REAR UNLESS ALSO USED ON FRONT TO AVOID BRAKE IMBALANCE.

**R** Suffix = High Durability Sintered Pad. **HH** Suffix = High Performance Sintered Pad. **G** Suffix = Grooved Shoe.  
**D** Suffix = Drilled Disc. **C** Suffix = Contoured Disc. **LS** Suffix = Left/Steel Disc. **RS** = Right/Steel Disc.

**BRAKE  
APPLICATIONS**

# Non-Japanese Built Motorcycles/Quads



## BIMOTA contd.

SB8K Gobert (Suzuki Engine) (996cc) 06  
SB8K Santamonica (Suzuki Engine) (996cc)

## BLANEY (Quads)

FX 50 03-04  
FX 90 03-04  
XC 125 Trojan 03-04  
XL 200 Trooper 03-04

## BLATA

Enduro 125 07  
Motard 125 07

## BMW

|   |             | 1                                  | 2                                  | 3                 | 4                   | 5  | 6                                  | 7                                  | 8                             | 9 |
|---|-------------|------------------------------------|------------------------------------|-------------------|---------------------|--|------------------------------------|------------------------------------|-------------------------------|---|
|   |             | Sintered/HH Pads/<br>Grooved shoes | Sintered/HH Pads/<br>Grooved shoes | Left/Gauche/Links | Right/Droite/Rechts | Contour Rotor<br>Universal left and<br>right fitment | Sintered/HH Pads/<br>Grooved shoes | Sintered/HH Pads/<br>Grooved shoes | Contour Rotor<br>Rear fitment |   |
| C1 125  | 99-03       | FA209/2                            | FA209/2HH                          | MD968D            |                     |  | FA213                              | FA213HH                            | MD968D                        |   |
| C1 200  | 01-03       | FA209/2                            | FA209/2HH                          | MD968D            |                     |  | FA213                              | FA213HH                            | MD968D                        |   |
| F 650/650 ST (Chain driven/inc ABS models)      | 93-00       | FA209/2                            | FA209/2HH                          | MD650LS②          |                     |  | FA213                              | FA213HH                            | MD651                         |   |
| F 650 GS/Dakar GS (Chain driven/inc ABS models) | 93-07       | FA209/2                            | FA209/2HH                          | MD650LS②          |                     |  | FA213                              | FA213HH                            | MD651                         |   |
| F 650 CS/Scarver (Belt driven/inc ABS models)   | 00-06       | FA209/2                            | FA209/2HH                          |                   | MD650RS②            |  | FA213                              | FA213HH                            | MD651                         |   |
| F 800 S/ST                                      | 06-07       | FA244*                             | FA244HH*                           | MD620LS           |                     | MD620RS  | FA213                              | FA213HH                            | MD671                         |   |
| G 650 Xchallenge                                | 07          | FA209/2                            | FA209/2HH                          | MD650LS           |                     |  | FA213                              | FA213HH                            | MD651                         |   |
| G 650 Xmoto                                     | 07          | FA244                              | FA244HH                            | TBA               |                     |  | FA213                              | FA213HH                            | MD651                         |   |
| G 650 Xcountry                                  | 07          | FA209/2                            | FA209/2HH                          | MD650LS           |                     |  | FA213                              | FA213HH                            | MD651                         |   |
| HP2 1200 "Enduro"                               | 05-07       | FA209/2                            | FA209/2HH                          | TBA               |                     |  | FA363                              | FA363HH                            | MD671                         |   |
| HP2 Megamoto                                    | 07          |                                    | FA335HH*                           | MD620LS           | MD620RS             |  | FA363                              | FA363HH                            | MD671                         |   |
| K 75/75-S (Non ABS)                             | 84-08/88    | FA18*                              | FA18HH*                            | MD604LS           | MD604RS             |  | 863                                |                                    |                               |   |
| K 75/75-2 (Non ABS)                             | 84-07/90    | FA18*                              | FA18HH*                            | MD603LS           | MD603RS             |  | 861                                |                                    |                               |   |
| K 75/75-2 (Non ABS)                             | 09/88-96    | FA171*                             | FA171HH*                           | MD604LS           | MD604RS             |  | 861                                |                                    |                               |   |
| K 75/75-S (ABS Model)                           | 08/90-96    | FA171*                             | FA171HH*                           | MD603LS②          | MD603RS②            |  | FA18                               | FA18HH                             | MD611②                        |   |
| K 75 C  | 85-08/88    | FA18*                              | FA18HH*                            | MD604LS           | MD604RS             |  | 861                                |                                    |                               |   |
| K 75 C  | 09/88-02/88 | FA171*                             | FA171HH*                           | MD604LS           | MD604RS             |  | 861                                |                                    |                               |   |
| K 75 RT (Non ABS)                               | 89-96       | FA171*                             | FA171HH*                           | MD604LS           | MD604RS             |  | FA18                               | FA18HH                             | MD611                         |   |
| K 75 RT (ABS Model)                             | 89-96       | FA171*                             | FA171HH*                           | MD603LS②          | MD603RS②            |  | FA18                               | FA18HH                             | MD611②                        |   |
| K 75 S (Non ABS)                                | 85-09/88    | FA18*                              | FA18HH*                            | MD604LS           | MD604RS             |  | FA18                               | FA18HH                             | MD611                         |   |
| K 75 S (Non ABS Model)                          | 09/88-95    | FA171*                             | FA171HH*                           | MD604LS           | MD604RS             |  | FA18                               | FA18HH                             | MD611                         |   |
| K 75 S (ABS Model)                              | 85-09/88    | FA18*                              | FA18HH*                            | MD603LS②          | MD603RS②            |  | FA18                               | FA18HH                             | MD611②                        |   |
| K 75 S (ABS Model)                              | 09/88-95    | FA171*                             | FA171HH*                           | MD603LS②          | MD603RS②            |  | FA18                               | FA18HH                             | MD611②                        |   |
| K 1000 (Non ABS - 8 valve model)                | 82-09/88    | FA18*                              | FA18HH*                            | MD604LS           | MD604RS             |  | FA18                               | FA18HH                             | MD611                         |   |
| K 100/2 (Non ABS - 8 valve model)               | 87-08/88    | FA18*                              | FA18HH*                            | MD604LS           | MD604RS             |  | FA18                               | FA18HH                             | MD611                         |   |
| K 100/2 (Non ABS - 8 valve model)               | 09/88-90    | FA171*                             | FA171HH*                           | MD604LS           | MD604RS             |  | FA18                               | FA18HH                             | MD611                         |   |
| K 100/2 (ABS - 8 valve model)                   | 87-08/88    | FA18*                              | FA18HH*                            | MD603LS②          | MD603RS②            |  | FA18                               | FA18HH                             | MD661②                        |   |
| K 100/2 (ABS - 8 valve model)                   | 09/88-90    | FA171*                             | FA171HH*                           | MD603LS②          | MD603RS②            |  | FA18                               | FA18HH                             | MD661②                        |   |
| K 100 LT (Non ABS - 8 valve model)              | 86-08/88    | FA18*                              | FA18HH*                            | MD604LS           | MD604RS             |  | FA18                               | FA18HH                             | MD611                         |   |
| K 100 LT (Non ABS - 8 valve model)              | 09/88-91    | FA171*                             | FA171HH*                           | MD604LS           | MD604RS             |  | FA18                               | FA18HH                             | MD611                         |   |
| K 100 LT (ABS - 8 valve model)                  | 86/-8/88    | FA18*                              | FA18HH*                            | MD603LS②          | MD603RS②            |  | FA18                               | FA18HH                             | MD661②                        |   |
| K 100 LT (ABS - 8 valve model)                  | 09/88-91    | FA171*                             | FA171HH*                           | MD603LS②          | MD603RS②            |  | FA18                               | FA18HH                             | MD661②                        |   |
| K 100 RS (Non ABS - 8 valve)                    | 83-09/88    | FA18*                              | FA18HH*                            | MD604LS           | MD604RS             |  | FA18                               | FA18HH                             | MD611                         |   |
| K 100 RS (Non ABS - 8 valve)                    | 10/88-89    | FA171*                             | FA171HH*                           | MD604LS           | MD604RS             |  | FA18                               | FA18HH                             | MD611                         |   |
| K 100 RS (ABS Model - 8 valve)                  | 83-09/88    | FA18*                              | FA18HH*                            | MD603LS②          | MD603RS②            |  | FA18                               | FA18HH                             | MD661②                        |   |
| K 100 RS (ABS Model - 8 valve)                  | 10/88-89    | FA171*                             | FA171HH*                           | MD603LS②          | MD603RS②            |  | FA18                               | FA18HH                             | MD661②                        |   |
| K 100 RT (Non ABS - 8 valve)                    | 83-09/88    | FA18*                              | FA18HH*                            | MD604LS           | MD604RS             |  | FA18                               | FA18HH                             | MD611                         |   |
| K 100 RT (Non ABS - 8 valve)                    | 10/88-89    | FA171*                             | FA171HH*                           | MD604LS           | MD604RS             |  | FA18                               | FA18HH                             | MD661                         |   |
| K 100 RT (ABS - 8 valve)                        | 83-09/88    | FA18*                              | FA18HH*                            | MD603LS②          | MD603RS②            |  | FA18                               | FA18HH                             | MD661②                        |   |
| K 100 RT (ABS - 8 valve)                        | 10/88-89    | FA171*                             | FA171HH*                           | MD603LS②          | MD603RS②            |  | FA18                               | FA18HH                             | MD661②                        |   |
| K 100 RS (16 valve - Non ABS)                   | 89-92       | FA407*                             | FA407HH*                           | MD607LS           | MD607RS             |  | FA18                               | FA18HH                             | MD611                         |   |
| K 100 RS (16 valve - ABS Models)                | 89-92       | FA407*                             | FA407HH*                           | MD607LS②          | MD607RS②            |  | FA18                               | FA18HH                             | MD661②                        |   |
| K1 (16 valve - Non ABS)                         | 88-93       | FA407*                             | FA407HH*                           | MD607LS           | MD607RS             |  | FA18                               | FA18HH                             | MD611                         |   |
| K1 (16 valve - ABS models)                      | 88-93       | FA407*                             | FA407HH*                           | MD607LS②          | MD607RS②            |  | FA18                               | FA18HH                             | MD661②                        |   |
| K 1100 LT (Non ABS)                             | 89-07/93    | FA407*                             | FA407HH*                           | MD607LS           | MD607RS             |  | FA18                               | FA18HH                             | MD611                         |   |
| KL 1100 LT (ABS)                                | 89-07/93    | FA407*                             | FA407HH*                           | MD607LS②          | MD607RS②            |  | FA18                               | FA18HH                             | MD661②                        |   |

\*-2 Sets Required. ■ - Also available in MX-S race compound, see page 8. ✖ - Oversize and Supermoto disc available - see page 301.

**SAFETY WARNING-** DO NOT USE HH PADS ON REAR UNLESS ALSO USED ON FRONT TO AVOID BRAKE IMBALANCE.

# Non-Japanese Built Motorcycles/Quads



BMW contd.

|   |             | Front/Avant/Vorn |                                    |                       | Frente/Anteriore        |  | Rear/Arrière/Hinten |                                    |        | Posterior/Posteriore          |  |
|---|-------------|------------------|------------------------------------|-----------------------|-------------------------|--|---------------------|------------------------------------|--------|-------------------------------|--|
|   |             | 1                | 2                                  | 3                     | 4                       | 5  | 6                   | 7                                  | 8      | 9                             |  |
|   |             |                  | Sintered/HH Pads/<br>Grooved shoes | Left/Gauche/Links<br> | Right/Droite/Rechts<br> | Contour Rotor<br>Universal left and<br>right fitment |                     | Sintered/HH Pads/<br>Grooved shoes |        | Contour Rotor<br>Rear fitment |  |
| K 1100 LT (Non ABS)   | 08/93-99    | FA407*           | FA407HH*                           | MD607LS               | MD607RS                 |  | FA18                | FA18HH                             | MD661  |                               |  |
| K 1100 LT (ABS Model)   | 08/93-99    | FA407*           | FA407HH*                           | MD607LS②              | MD607RS②                |  | FA18                | FA18HH                             | MD661② |                               |  |
| K 1100 RS (Non ABS Model)   | 92-96       | FA407*           | FA407HH*                           | MD607LS               | MD607RS                 |  | FA18                | FA18HH                             | MD661  |                               |  |
| K 1100 RS (ABS Model)   | 92-96       | FA407*           | FA407HH*                           | MD607LS②              | MD607RS②                |  | FA18                | FA18HH                             | MD661② |                               |  |
| K 1200 RS (Non ABS & ABS Models)  | 96-00       | FA407*           | FA407HH*                           | MD652LS②              | MD652RS②                | MD652C*  | FA18                | FA18HH                             | MD661② |                               |  |
| K 1200 RS (With & Without Integral ABS)   | 01-04       |                  | FA335HH*                           | MD620LS②              | MD620RS②                |  | FA18                | FA18HH                             | MD661② |                               |  |
| K 1200 LT (Integral ABS & STD ABS Models)   | 97-10/00    | FA407*           | FA407HH*                           | MD652LS②              | MD652RS②                | MD652C*  | FA304               | FA304HH                            | MD615② |                               |  |
| K 1200 LT (Evo-Integral ABS)  | 11/00-07    |                  | FA294HH*                           | MD616LS②              | MD616RS②                |  | FA304               | FA304HH                            | MD615② |                               |  |
| K 1200 GT (2 pin rear pad K41)  | 03-06       |                  | FA335HH*                           | MD620LS               | MD620RS                 |  | FA18                | FA18HH                             | MD661  |                               |  |
| K 1200 GT (K44)   | Left 06-07  |                  | FA335HH                            | MD620LS               |                         |  |                     | FA438HH                            | MD688  |                               |  |
|   | Right       |                  | FA441HH                            |                       | MD620RS                 |  |                     |                                    |        |                               |  |
| *Bike is fitted with pad wear sensors. These are not available separately from BMW. EBC part no. for these are as follows:<br>You will need to order 1 kit for the r/h pad set, and 1 kit for the rear pad set. |             |                  |                                    |                       |                         |  |                     |                                    |        |                               |  |
|   |             | MWL001           |                                    |                       |                         |  | MWL002              |                                    |        |                               |  |
| K 1200 R  | 05-07       |                  | FA294HH*                           | MD616LS               | MD616RS                 |  | FA363               | FA363HH                            | MD671  |                               |  |
| K 1200 R Sport  | 07          |                  | FA294HH*                           | MD616LS               | MD616RS                 |  | FA363               | FA363HH                            | MD671  |                               |  |
| K 1200 S (K40)  | 05-06       |                  | FA335HH*                           | MD620LS               | MD620RS                 |  | FA363               | FA363HH                            | MD671  |                               |  |
| R 45/45 N (Single rotor with ATE caliper)   | 78-09/80    | FA57             |                                    | MD606LS               |                         |  | 860                 |                                    |        |                               |  |
| R 45/45 N (Twin rotor with ATE caliper)   | 8-09/80     | FA57*            |                                    | MD606LS               | MD606RS                 |  | 860                 |                                    |        |                               |  |
| R 45/45 N (Single rotor with ATE caliper)   | 10/80-85    | FA57             |                                    | MD606LS               |                         |  | 861                 |                                    |        |                               |  |
| R 45/45 N (Twin rotor with ATE caliper)   | 10/80-85    | FA57*            |                                    | MD606LS               | MD606RS                 |  | 861                 |                                    |        |                               |  |
| R 45/45 N (Single rotor with Brembo caliper)  | 78-90/80    | FA18             | FA18HH                             | MD606LS               |                         |  | 860                 |                                    |        |                               |  |
| R 45/45 N (Twin rotor with Brembo caliper)  | 78-90/80    | FA18*            | FA18HH*                            | MD606LS               | MD606RS                 |  | 860                 |                                    |        |                               |  |
| R 45/45 N (Single rotor with Brembo caliper)  | 10/80-85    | FA18*            | FA18HH*                            | MD606LS               |                         |  | 861                 |                                    |        |                               |  |
| R 45/45 N (Twin rotor with Brembo calipers)   | 10/80-85    | FA18*            | FA18HH*                            | MD606LS               | MD606RS                 |  | 861                 |                                    |        |                               |  |
| R 45 T  | 80-85       | FA57             |                                    | MD606LS               |                         |  | 861                 |                                    |        |                               |  |
| R 50/5 / 60/5 / 60/6 / 75/5   | 69-76       | 864              |                                    |                       |                         |  | 860                 |                                    |        |                               |  |
| R 60/7 (Single rotor)   | 76-80       | FA22             |                                    | MD602LS               |                         |  | 860                 |                                    |        |                               |  |
| R 60/7 (Double rotor model)   | 76-80       | FA22*            |                                    | MD602LS               | MD602RS                 |  | 860                 |                                    |        |                               |  |
| R 60 TIC (Single rotor)   | 78-82       | FA22             |                                    | MD602LS               |                         |  | 860                 |                                    |        |                               |  |
| R 60 TIC (Double rotor model)   | 78-82       | FA22*            |                                    | MD602LS               | MD602RS                 |  | 860                 |                                    |        |                               |  |
| R 65 (Single rotor)   | 07/88-08/89 | FA77             |                                    | N/A                   |                         |  | 861                 |                                    |        |                               |  |
| R 65 (Double rotor model)   | 07/88-08/89 | FA18*            | FA18HH*                            | MD605LS               | MD605RS                 |  | 861                 |                                    |        |                               |  |
| R 65 GS   | 87-92       | FA18             | FA18HH                             |                       | MD606RS                 |  | 861                 |                                    |        |                               |  |
| R 65 LS (ATE caliper)   | 81-85       | FA57*            |                                    | MD606LS               | MD606RS                 |  | 862                 |                                    |        |                               |  |
| R 65 LS (Brembo Caliper)  | 81-85       | FA18*            | FA18HH*                            | MD606LS               | MD606RS                 |  | 862                 |                                    |        |                               |  |
| R 65 T (Brembo Caliper)   | 80-85       | FA18             | FA18HH                             | MD606LS               |                         |  | 861                 |                                    |        |                               |  |
| R 65 RT   | 85-88       | FA18*            | FA18HH*                            | MD605LS               | MD605RS                 |  | 861                 |                                    |        |                               |  |
| R 65 T (ATE caliper)  | 80-85       | FA57             |                                    | MD606LS               |                         |  | 861                 |                                    |        |                               |  |
| R 75/6 (Single rotor) 75/7  | 73-79       | FA22             |                                    | MD602LS               |                         |  | 860                 |                                    |        |                               |  |
| R 75/6 (Twin rotor) 75/7  | 73-79       | FA22*            |                                    | MD602LS               | MD602RS                 |  | 860                 |                                    |        |                               |  |
| R 80 (Single rotor)   | 77-09/80    | FA22             |                                    | MD602LS               |                         |  | 860                 |                                    |        |                               |  |
| R 80 (Double rotor)   | 77-09/80    | FA22*            |                                    | MD602LS               | MD602RS                 |  | 860                 |                                    |        |                               |  |
| R 80 (Single rotor)   | 10/80-84    | FA22             |                                    | MD602LS               |                         |  | 861                 |                                    |        |                               |  |
| R 80 (Double rotor)   | 10/80-84    | FA22*            |                                    | MD602LS               | MD602RS                 |  | 861                 |                                    |        |                               |  |
| R 80/R 80 RT (Single rotor)   | 84-07/90    | FA77             |                                    | MD605LS               |                         |  | 861                 |                                    |        |                               |  |
| R 80 RT (Double rotor)  | 82-84       | FA18*            | FA18HH*                            | MD602LS               | MD602RS                 |  | 861                 |                                    |        |                               |  |
| R 80/R 80 RT (Double rotor)   | 84-08/88    | FA18*            | FA18HH*                            | MD605LS               | MD605RS                 |  | 861                 |                                    |        |                               |  |
| R 80/R 80 RT (Single rotor)   | 08/90-95    | FA77             |                                    |                       | MD605RS                 |  | 861                 |                                    |        |                               |  |
| R 80/R 80 RT (Double rotor)   | 09/88-95    | FA171*           | FA171HH*                           | MD605LS               | MD605RS                 |  | 859                 |                                    |        |                               |  |
| R 80 GS   | 80-87       | FA18             | FA18HH                             |                       | MD606RS                 |  | 861                 |                                    |        |                               |  |
| R 80 GS   | 87-95       | FA77             |                                    |                       | MD605RS                 |  | 859                 |                                    |        |                               |  |
| R 80 PD/CH  | 90-95       | FA77             |                                    |                       | MD605RS                 |  | 859                 |                                    |        |                               |  |
| R 80 ST   | 82-84       | FA18             | FA18HH                             |                       | MD606RS                 |  | 861                 |                                    |        |                               |  |
| R 80 TIC  | 78-08/80    | FA22*            |                                    | MD602LS               | MD602RS                 |  | 860                 |                                    |        |                               |  |
| R 80 TIC  | 09/80-85    | FA18*            | FA18HH*                            | MD602LS               | MD602RS                 |  | 861                 |                                    |        |                               |  |
| R 80 'Mystic'   | 94-95       | FA407*           | FA407HH*                           | MD605LS               | MD605RS                 |  | 859                 |                                    |        |                               |  |
| R 80 R  | 91-94       | FA407*           | FA407HH*                           | MD605LS               | MD605RS                 |  | 859                 |                                    |        |                               |  |
| R 850 C (Cast wheel/ABS)  | 97-00       | FA407*           | FA407HH*                           | MD652LS②              | MD652RS②                | MD652C*  | FA363               | FA363HH                            | N/A    |                               |  |

\*-2 Sets Required. ■ - Also available in MX-S race compound, see page 8. ✖ - Oversize and Supermoto disc available - see page 301.

**SAFETY WARNING-** DO NOT USE HH PADS ON REAR UNLESS ALSO USED ON FRONT TO AVOID BRAKE IMBALANCE.

R Suffix = High Durability Sintered Pad. HH Suffix = High Performance Sintered Pad. G Suffix = Grooved Shoe.  
D Suffix = Drilled Disc. C Suffix = Contoured Disc. LS Suffix = Left/Steel Disc. RS = Right/Steel Disc.

BRAKE APPLICATIONS

# Non-Japanese Built Motorcycles/Quads



APPLICATIONS  
BRAKE

R Suffix = High Durability Sintered Pad. HH Suffix = High Performance Sintered Pad. G Suffix = Grooved Shoe.

D Suffix = Drilled Disc. C Suffix = Contoured Disc. LS Suffix = Left/Steel Disc. RS = Right/Steel Disc.

BMW contd.

|                                   |             | Front/Avant/Vorn                   |                   |                     | Frente/Anteriore                                     |                                    | Rear/Arrière/Hinten                |                               |         | Posterior/Posteriore |  |
|-----------------------------------|-------------|------------------------------------|-------------------|---------------------|--|------------------------------------|------------------------------------|-------------------------------|---------|----------------------|--|
|                                   |             | 1                                  | 2                 | 3                   | 4  | 5                                  | 6                                  | 7                             | 8       | 9                    |  |
|                                   |             | Sintered/HH Pads/<br>Grooved shoes | Left/Gauche/Links | Right/Droite/Rechts | Contour Rotor<br>Universal left and<br>right fitment | Sintered/HH Pads/<br>Grooved shoes | Sintered/HH Pads/<br>Grooved shoes | Contour Rotor<br>Rear fitment |         |                      |  |
| R 850 C (Spoke wheel/ABS)         | 97-00       | FA407*                             | FA407HH*          | MD652LS②            | MD652RS②   | MD652C*                            | FA363                              | FA363HH                       | N/A     |                      |  |
| R 850 GS                          | 96          | FA77                               |                   |                     | MD605RS  |                                    | 859                                |                               |         |                      |  |
| R 850 GS (Std & ABS models)       | 96-00       | FA407*                             | FA407HH*          | MD652LS②            | MD652RS②   | MD652C*                            | FA363                              |                               | MD653①  | MD653C               |  |
| R 850 R (Cast wheel/ABS)          | 94-02       | FA407*                             | FA407HH*          | MD607LS②            | MD607RS②   |                                    | FA363                              |                               | MD653①  |                      |  |
| R 850 R (Spoke wheel)             | 94-05/96    | FA407*                             | FA407HH*          | MD652LS             | MD652RS  | MD652C*                            | FA363                              |                               | MD653   | MD653C               |  |
| R 850 R                           | 04-06       | FA294*                             | FA294HH*          | MD616LS             | MD616RS  |                                    | FA363                              | FA363HH                       | MD653   |                      |  |
| R 850 RT (Cast wheel/ABS)         | 96-01       | FA407*                             | FA407HH*          | MD607LS②            | MD607RS②   |                                    | FA363                              |                               | MD653②  |                      |  |
| R 850 RT (Spoke wheel)            | 96-01       | FA407*                             | FA407HH*          | MD652LS             | MD652RS  | MD652C*                            | FA363                              |                               | MD653   | MD653C               |  |
| R 850 RT                          | 06          |                                    | FA335HH*          | MD620LS             | MD620RS  |                                    | FA363                              | FA363HH                       | MD653   |                      |  |
| R 90 S                            | 73-76       | FA22*                              |                   | MD602LS             | MD602RS  |                                    | 860                                |                               |         |                      |  |
| R 90/6 (Single rotor)             | 73-76       | FA22                               |                   | MD602LS             |  |                                    | 860                                |                               |         |                      |  |
| R 90/6 (Twin rotor)               | 73-76       | FA22*                              |                   | MD602LS             | MD602RS  |                                    | 860                                |                               |         |                      |  |
| R 100 (Single rotor)              | 76-77       | FA22                               |                   | MD602LS             |  |                                    | 860                                |                               |         |                      |  |
| R 100 (Twin rotor)                | 76-77       | FA22*                              |                   | MD602LS             | MD602RS  |                                    | 860                                |                               |         |                      |  |
| R 100 GS                          | 86-94       | FA77                               |                   |                     | MD605RS  |                                    | 859                                |                               |         |                      |  |
| R 100 PD                          | 89-96       | FA77                               |                   |                     | MD605RS  |                                    | 859                                |                               |         |                      |  |
| R 100/7T (Single rotor)           | 77-09/80    | FA22                               |                   | MD602LS             |  |                                    | 860                                |                               |         |                      |  |
| R 100/7T (Twin rotor)             | 77-09/80    | FA22*                              |                   | MD602LS             | MD602RS  |                                    | 860                                |                               |         |                      |  |
| R 100/7T (Spoke wheel)            | 09/80-84    | FA18*                              | FA18HH*           | MD606LS             | MD606RS  |                                    | 861                                |                               |         |                      |  |
| R 100/7T (Cast wheel)             | 09/80-84    | FA18*                              | FA18HH*           | MD602LS             | MD602RS  |                                    | 861                                |                               |         |                      |  |
| R 100 S                           | 76-08/80    | FA22*                              |                   | MD602LS             | MD602RS  |                                    | 860                                |                               |         |                      |  |
| R 100 S                           | 09/80-80    | FA18*                              | FA18HH*           | MD602LS             | MD602RS  |                                    | FA18                               | FA18HH                        | MD602LS |                      |  |
| R 100 RS                          | 76-09/80    | FA22*                              |                   | MD602LS             | MD602RS  |                                    | 860                                |                               |         |                      |  |
| R 100 RS                          | 10/80-84    | FA18*                              | FA18HH*           | MD602LS             | MD602RS  |                                    | FA18                               | FA18HH                        | MD602LS |                      |  |
| R 100 RS                          | 86-08/88    | FA18*                              | FA18HH*           | MD605LS             | MD605RS  |                                    | 861                                |                               |         |                      |  |
| R 100 RS                          | 09/88-08/89 | FA171*                             | FA171HH*          | MD605LS             | MD605RS  |                                    | 861                                |                               |         |                      |  |
| R 100 RS                          | 9/9-92      | FA171*                             | FA171HH*          | MD605LS             | MD605RS  |                                    | 859                                |                               |         |                      |  |
| R 100 RT                          | 78-09/80    | FA22*                              |                   | MD602LS             | MD602RS  |                                    | 860                                |                               |         |                      |  |
| R 100 RT                          | 10/80-84    | FA18*                              | FA18HH*           | MD602LS             | MD602RS  |                                    | FA18                               | FA18HH                        | MD602LS |                      |  |
| R 100 RT                          | 87-08/88    | FA18*                              | FA18HH*           | MD605LS             | MD605RS  |                                    | 861                                |                               |         |                      |  |
| R 100 RT                          | 09/88-08/89 | FA171*                             | FA171HH*          | MD605LS             | MD605RS  |                                    | 861                                |                               |         |                      |  |
| R 100 RT                          | 09/89-95    | FA171*                             | FA171HH*          | MD605LS             | MD605RS  |                                    | 859                                |                               |         |                      |  |
| R 100 'Mystic'                    | 93-96       | FA407*                             | FA407HH*          | MD605LS             | MD605RS  |                                    | 859                                |                               |         |                      |  |
| R 100 R                           | 91-95       | FA407*                             | FA407HH*          | MD605LS             | MD605RS  |                                    | 859                                |                               |         |                      |  |
| R 1100 GS (STD & ABS)             | 93-99       | FA407*                             | FA407HH*          | MD652LS②            | MD652RS②   | MD652C*                            | FA363                              | FA363HH                       | MD653②  | MD653C               |  |
| R 1100 R (Spoke wheel)            | 93-05/96    | FA407*                             | FA407HH*          | MD652LS             | MD652RS  | MD652C*                            | FA363                              | FA363HH                       | MD653   | MD653C               |  |
| R 1100 R (Spoke wheel)            | 06/96       | FA407*                             | FA407HH*          | MD652LS             | MD652RS  | MD652C*                            | FA363                              | FA363H                        | MD653   | MD653C               |  |
| R 1100 R (Cast wheel)             | 93-01       | FA407*                             | FA407HH*          | MD607LS             | MD607RS  |                                    | FA363                              | FA363HH                       | MD653①  |                      |  |
| R 1100 RS                         | 92-01       | FA407*                             | FA407HH*          | MD607LS             | MD607RS  |                                    | FA18                               | FA18HH                        | MD661   |                      |  |
| R 1100 S                          | 96-11/00    | FA407*                             | FA407HH*          | MD687LS             | MD687RS  |                                    | FA363                              | FA363HH                       | MD653   | MD653C               |  |
| R 1100 S (With integral ABS)      | 12/00-06    |                                    | FA294HH*          | MD616LS②            | MD616RS②   |                                    | FA363                              | FA363HH                       | MD653②  |                      |  |
| R 1100 S (Without integral ABS)   | 12/00-03    |                                    | FA335HH*          | MD620LS             | MD620RS  |                                    | FA363                              | FA363HH                       | MD653   |                      |  |
| R 1100 RT (Cast wheel/ABS)        | 94-01       | FA407*                             | FA407HH*          | MD607LS②            | MD607RS②   |                                    | FA363                              | FA363HH                       | MD653②  |                      |  |
| R 1100 RT (Spoke wheel)           | 94-01       | FA407*                             | FA407HH*          | MD652LS             | MD652RS  | MD652C*                            | FA363                              | FA363HH                       | MD653   | MD653C               |  |
| R 1150 GS (ABS & Non ABS)         | 98-11.01    | FA407*                             | FA407HH*          | MD652LS②            | MD652RS②   | MD652C*                            | FA363                              | FA363HH                       | MD653②  | MD653C               |  |
| R 1150 GS (Evo System/ABS)        | 12/01-04    |                                    | FA335HH*          | MD652LS②            | MD652RS②   | MD652C*                            | FA363                              | FA363HH                       | MD653②  | MD653C               |  |
| R 1150 GS (Adventure)             | 03-06       |                                    | FA294HH*          | MD616LS             | MD616RS  |                                    | FA363                              | FA363HH                       | MD653   |                      |  |
| R 1150 R                          | 01-06       |                                    | FA294HH*          | MD616LS             | MD616RS  |                                    | FA363                              | FA363HH                       | MD653   |                      |  |
| R 1150 RS (Integral ABS)          | 01-04       |                                    | FA294HH*          | MD616LS②            | MD616RS②   |                                    | FA363                              | FA363HH                       | MD653②  |                      |  |
| R 1150 RT (Integral ABS)          | 00-04       |                                    | FA335HH*          | MD620LS②            | MD620RS②   |                                    | FA363                              | FA363HH                       | MD653②  |                      |  |
| R 1150 R Rockster                 | 03-06       |                                    | FA294HH*          | MD616LS             | MD616RS  |                                    | FA363                              | FA363HH                       | MD653   |                      |  |
| R 1150 R Rockster Edition 80      | 04          |                                    | FA294HH*          | MD616LS             | MD616RS  |                                    | FA363                              | FA363HH                       | MD653   |                      |  |
| R 1200 (Independence/Cast Wheel)  | 00-02       | FA407*                             | FA407HH*          | MD652LS             | MD652RS  | MD652C*                            | FA363                              | FA363HH                       | N/A     |                      |  |
| R 1200 (Independence/Spoke Wheel) | 00-02       | FA407*                             | FA407HH*          | MD652LS             | MD652RS  | MD652C*                            | FA363                              | FA363HH                       | N/A     |                      |  |
| R 1200 C (Cast Wheel/ABS)         | 96-02       | FA407*                             | FA407HH*          | MD652LS②            | MD652RS②   | MD652C*                            | FA363                              | FA363HH                       | N/A     |                      |  |
| R 1200 C (Spoke Wheel/ABS)        | 96-02       | FA407*                             | FA407HH*          | MD652LS②            | MD652RS②   | MD652C*                            | FA363                              | FA363HH                       | N/A     |                      |  |
| R 1200 C Independent (Cast Wheel) | 03-04       |                                    | FA294HH*          | MD652LS             | MD652RS  | MD652C*                            | FA363                              | FA363HH                       | N/A     |                      |  |
| R 1200 C Montauk                  | 04          |                                    | FA294HH*          |                     |  |                                    | FA363                              | FA363HH                       | N/A     |                      |  |
| R 1200 C Classic                  | 03-04       |                                    | FA294HH*          |                     |  |                                    | FA363                              | FA363HH                       | N/A     |                      |  |
| R 1200 CL                         | 03-04       |                                    | FA294HH*          |                     |  |                                    | FA304                              | FA304HH                       | MD615   |                      |  |

\*-2 Sets Required. ■ - Also available in MX-S race compound, see page 8. ✖ - Oversize and Supermoto disc available - see page 301.

**SAFETY WARNING-** DO NOT USE HH PADS ON REAR UNLESS ALSO USED ON FRONT TO AVOID BRAKE IMBALANCE.

# Non-Japanese Built Motorcycles/Quads



Front/Avant/Vorn



Frente/Anteriore

Rear/Arrière/Hinten



Posterior/Posteriore

BMW contd.

|                                   |       | ①                              | ②                 | ③                   | ④  | ⑤                              | ⑥                              | ⑦                          | ⑧ | ⑨ |
|-----------------------------------|-------|--------------------------------|-------------------|---------------------|--|--------------------------------|--------------------------------|----------------------------|---|---|
|                                   |       | Sintered/HH Pads/Grooved shoes | Left/Gauche/Links | Right/Droite/Rechts | Contour Rotor Universal left and right fitment | Sintered/HH Pads/Grooved shoes | Sintered/HH Pads/Grooved shoes | Contour Rotor Rear fitment |   |   |
| R 1200 GS                         | 04-07 | FA335HH*                       | MD652LS           | MD652RS             | MD652C   | FA363                          | FA363HH                        | MD671                      |   |   |
| R 1200 RT (K26)                   | 05-07 | FA335HH*                       | MD620LS           | MD620RS             |  | FA363                          | FA363HH                        | MD671                      |   |   |
| R 1200 ST (K28)                   | 03-07 | FA335HH*                       | MD620LS           | MD620RS             |  | FA363                          | FA363HH                        | MD671                      |   |   |
| R 1200 R Sport                    | 06-07 | FA294HH*                       | MD616LS           | MD616RS             |  | FA363                          | FA363HH                        | MD671                      |   |   |
| R 1200 S                          | 06-07 | FA335HH*                       | MD620LS           | MD620RS             |  | FA363                          | FA363HH                        | MD671                      |   |   |
| R 1200 GS Adventure (Spoke wheel) | 07    | FA335HH*                       | MD687LS           | MD687RS             |  | FA363                          | FA363HH                        | MD671                      |   |   |

**IMPORTANT NOTE** ① - remove rotor outer ring from centre casting and refit.

② - remove ABS ring from old rotor and refit to new EBC rotor. Note: Ensure all mounting surfaces are clean and when refitting bolts use a thread lock cement to hold them in place.

## BORILE

|          |       |      |        |     |  |         |  |     |  |  |
|----------|-------|------|--------|-----|--|---------|--|-----|--|--|
| B 500 CR | 02-04 | FA95 | FA95H  | N/A |  | FA208TT |  | N/A |  |  |
| B 500 MT | 02    | FA95 | FA95HH | N/A |  | FA208TT |  | N/A |  |  |

## BSA

|           |  |     |  |  |  |     |  |  |  |  |
|-----------|--|-----|--|--|--|-----|--|--|--|--|
| Bantam D7 |  | 858 |  |  |  | 858 |  |  |  |  |
|-----------|--|-----|--|--|--|-----|--|--|--|--|

## BSM

|        |  |         |         |        |        |        |        |        |  |  |
|--------|--|---------|---------|--------|--------|--------|--------|--------|--|--|
| TB 100 |  | FA83TT* | FA83HH* | MD923D | MD923D | Y503   |        |        |  |  |
| TB 125 |  | FA83TT  | FA83HH  | MD923D | MD923D | FA83TT | FA83HH | MD923D |  |  |
| FT 125 |  | FA56    |         | N/A    |        | S602   |        |        |  |  |

## BULTACO

|   |  |  |      |  |  |  |      |  |  |  |
|---|--|--|------|--|--|--|------|--|--|--|
| Lobito 125 and 250 cc                           |  |  | 831G |  |  |  | 831G |  |  |  |
| Sherpa 250/350 N/A/I                            |  |  | 831G |  |  |  | 831G |  |  |  |
| Sherpa (91-250cc & 92-350cc)                    |  |  | 831G |  |  |  | N/A  |  |  |  |
| Sherpa (124-250cc, 125-350cc), (150-250cc, 151) |  |  | 831G |  |  |  | 833G |  |  |  |
| Sherpa (198-250cc & 199-350cc)                  |  |  | 831G |  |  |  | 831G |  |  |  |
| Fronter 250/360/370 all models                  |  |  | 833G |  |  |  | 833G |  |  |  |
| Pursang MK6 125/175/200/250/350                 |  |  | 831G |  |  |  | N/A  |  |  |  |
| Pursang MK7 and MK8 125/250/360                 |  |  | 831G |  |  |  | 833G |  |  |  |
| Pursang MK9 125/200                             |  |  | 831G |  |  |  | 831G |  |  |  |
| Pursang MK9 250/370                             |  |  | 833G |  |  |  | 833G |  |  |  |
| Pursang MK10 250cc                              |  |  | 831G |  |  |  | 833G |  |  |  |
| Pursang MK10 370cc                              |  |  | 833G |  |  |  | 833G |  |  |  |
| Pursang MK11 250cc                              |  |  | 831G |  |  |  | 833G |  |  |  |
| Pursang MK11 370cc                              |  |  | 833G |  |  |  | 833G |  |  |  |
| Pursang MK12 250cc                              |  |  | 831G |  |  |  | 833G |  |  |  |
| Pursang MK12 370cc                              |  |  | 833G |  |  |  | 833G |  |  |  |

## CAGIVA

|                         |       |       |         |         |         |        |       |        |       |  |
|-------------------------|-------|-------|---------|---------|---------|--------|-------|--------|-------|--|
| Cucciolo 50             | 98-99 | FA47  | FA47HH  | TBA     |         | S624   |       |        |       |  |
| Stella 50               | 97    | FA264 |         | TBA     |         | FA264  |       | TBA    |       |  |
| Blues 50                | 93-95 | FA156 |         |         | N/A     | FA186  |       | N/A    |       |  |
| Mantis 50               | 99    | FA193 | FA193HH | TBA     |         | TBA    |       |        |       |  |
| Nuvola 50               | 00    | FA193 | FA193HH | TBA     |         | TBA    |       |        |       |  |
| Progress 50             | 97-99 | FA115 | FA115HH | N/A     |         | S624   |       |        |       |  |
| Super City 50/80        | 93-95 | FA156 |         |         | N/A     | FA186  |       | N/A    |       |  |
| Prima 50                | 92-94 | FA156 |         |         | N/A     | FA186  |       | N/A    |       |  |
| W4 50                   | 91-95 | FA47  | FA47HH  | N/A     |         | FA60   |       | N/A    |       |  |
| City 50                 | 91-94 | FA257 |         | MD933D  |         | 893    |       |        |       |  |
| Mito 50                 | 98-99 | FA167 | FA167HH | N/A     |         | FA115  |       | N/A    |       |  |
| WSXT 125 "Aletta Rossa" | 83-84 | FA60  |         | N/A     |         | 845    |       |        |       |  |
| XSST 125                | -80   | N/A   |         | N/A     |         | 844    |       |        |       |  |
| XSST 125                | 81-82 | FA60  |         | N/A     |         | 844    |       |        |       |  |
| SXT 125                 | 82    | FA60  |         | N/A     |         |        | 841WG |        |       |  |
| Blues 125               | 92-95 | FA256 |         | N/A     |         | FA47   |       | N/A    |       |  |
| Cucciolo 125            | 00    | FA47  | FA47HH  | MD9110D |         | 816    |       |        |       |  |
| Mito 125                | 91-92 | FA163 |         |         | MD614RS | MD614C | FA47  |        | MD638 |  |
| Mito 125 All models     | 93-07 | FA95  | FA95HH  |         | MD614RS | MD614C | FA47  | FA47HH | MD638 |  |
| Passing 125             | 93-97 | FA264 |         | N/A     |         | H303   |       |        |       |  |

\*-2 Sets Required. ■ - Also available in MX-S race compound, see page 8. ✖ - Oversize and Supermoto disc available - see page 301.

**SAFETY WARNING-** DO NOT USE HH PADS ON REAR UNLESS ALSO USED ON FRONT TO AVOID BRAKE IMBALANCE.

R Suffix = High Durability Sintered Pad. HH Suffix = High Performance Sintered Pad. G Suffix = Grooved Shoe.  
D Suffix = Drilled Disc. C Suffix = Contoured Disc. LS Suffix = Left/Steel Disc. RS = Right/Steel Disc.

BRAKE APPLICATIONS

# Non-Japanese Built Motorcycles/Quads



## CAGIVA contd.

|                               |       | Front/Avant/Vorn |            |          | Frente/Anteriore |        | Rear/Arrière/Hinten |         |         | Posterior/Posteriore |  |
|-------------------------------|-------|------------------|------------|----------|------------------|--------|---------------------|---------|---------|----------------------|--|
|                               |       | 1                | 2          | 3        | 4                | 5      | 6                   | 7       | 8       | 9                    |  |
| Raptor 125                    | 03-07 | FA95             | FA95HH     |          | MD614RS          | MD614C | FA47                | FA47HH  | MD638   |                      |  |
| Roadster 125                  | 96-97 | FA198            |            |          | N/A              |        | 949                 |         |         |                      |  |
| Roadster 125                  | 98-99 | FA256            |            |          | N/A              |        | 949                 |         |         |                      |  |
| Super City 125                | 92-00 | FA163            |            |          | MD614RS          | MD614C | FA47                |         | MD638   |                      |  |
| Freccia 125 SY                | 89    | FA163            |            |          | N/A              |        | FA47                |         | N/A     |                      |  |
| Nuvola 125                    | 00    | FA193            | FA193HH    | N/A      |                  |        | 816                 |         |         |                      |  |
| Planet 125                    | 99-03 | FA95             | FA95HH     |          | MD614RS          | MD614C | FA47                | FA47HH  | MD638   |                      |  |
| WMX 125 (Rimoldi Hub)         | -85   |                  | 944G       |          |                  |        |                     | 841G    |         |                      |  |
| WMX 125                       | 86    | FA47             | FA47R      | N/A      |                  |        |                     | 977G    |         |                      |  |
| WM 125                        | 87-88 | FA134            | FA134R     | N/A      |                  |        |                     | 977G    |         |                      |  |
| WMX 125                       | 89    | FA134            | FA134R     | N/A      |                  |        | FA67                | FA67R   | N/A     |                      |  |
| W8 125                        | 93-98 | FA163            |            |          | N/A              |        | FA60                |         | N/A     |                      |  |
| N1 125                        | 97    | FA95             | FA95HH     |          | MD614RS          | MD614C | FA47                | FA47HH  | TBA     |                      |  |
| SST 250                       | -80   | N/A              |            | N/A      |                  |        | 844                 |         |         |                      |  |
| SST 250/350                   | 80-82 | FA47             | FA47HH     | N/A      |                  |        |                     | 842G    |         |                      |  |
| SX 250/350                    | -82   |                  | 842G       |          |                  |        |                     | 842G    |         |                      |  |
| SX 250                        | 82    | FA47             | FA47HH     | N/A      |                  |        |                     | 842G    |         |                      |  |
| WMX 250                       | -85   | FA47             | FA47R      | N/A      |                  |        |                     | 841G    |         |                      |  |
| WMX 250                       | 86-88 | FA134            | FA134R     | N/A      |                  |        |                     | 977G    |         |                      |  |
| WMX 250                       | 89    | FA134            | FA134R     | N/A      |                  |        | FA67                | FA67R   | N/A     |                      |  |
| WMX 500                       | 84-86 | FA47             | FA47R      | N/A      |                  |        |                     | 982G    |         |                      |  |
| W 12 "350"                    | 93-95 | FA163            |            | N/A      |                  |        | FA173               |         | N/A     |                      |  |
| Canyon 500                    | 96-00 | FA124/2          | FA124/2HH  | MD1008LS |                  |        | FA165/2TT           |         | N/A     |                      |  |
| Mito 500                      | 07    | FA95             | FA95HH     |          | MD614RS          | MD614C | FA47                | FA47HH  | MD638   |                      |  |
| Excaliber 501 RLX             | 92    | FA134            |            | N/A      |                  |        | FA47                |         | N/A     |                      |  |
| W16 "600"                     | 94-98 | FA163            |            | N/A      |                  |        | FA173               |         | N/A     |                      |  |
| River 600                     | 95-99 | FA95             | FA95HH     |          | MD614RS          | MD614C | FA47                |         | MD638   |                      |  |
| Canyon 600                    | 96-99 | FA124/2          | FA124/2HH  | MD1008LS |                  |        | FA165/2TT           |         | MD6160D |                      |  |
| 650 Elefant                   | 85    | FA120            |            | N/A      |                  |        | FA47                |         | N/A     |                      |  |
| 650 Elefant                   | 88-89 | FA120            |            | MD6265D  |                  |        | FA47                |         | MD6259D |                      |  |
| V-Raptor/Raptor 650           | 01-07 | FA244*           | FA244HH*   | MD660LS  | MD660RS          |        | FA266               | FA266HH | MD617   |                      |  |
| 750 Elefant                   | 90-92 | FA134            |            | MD6265D  |                  |        | FA163               |         | MD6259D |                      |  |
| E 750 Elephant                | 93-95 | FA124/2          | FA124/2HH  | N/A      |                  |        | FA181TT             | FA181HH | MD6160D |                      |  |
| E 900 Elephant                | 90-92 | FA124/2*         | FA124/2HH* | TBA      | TBA              |        | FA165/2TT           |         | MD6160D |                      |  |
| E 900 Elephant                | 93-97 | FA181TT*         | MXS181*    | TBA      | TBA              |        | FA181TT             | MXS181  | MD6160D |                      |  |
| 900 IE "Canyon"/"Gran Canyon" | 98-00 | FA142*           | FA142HH*   | TBA      | TBA              |        | FA165/2TT           |         | MD6160D |                      |  |
| Navigator 1000                | 00-05 | FA142*           | FA142HH*   | MD1008LS | MD1008RS         |        | FA165/2TT           |         | N/A     |                      |  |
| Raptor/V-Raptor/X-tra         | 00-05 | FA244*           | FA244HH*   | MD660LS  | MD660RS          |        | FA266               | FA266HH | MD617   |                      |  |
| Raptor X3 1000                | 03-04 |                  | FA322/4HH* | MD666LS  | MD666RS          |        | FA266               | FA266HH | MD617   |                      |  |

## CASAL

|                             |  |      |  |     |  |  |     |  |  |  |
|-----------------------------|--|------|--|-----|--|--|-----|--|--|--|
| All disc models             |  | FA50 |  | N/A |  |  | N/A |  |  |  |
| Mofas                       |  | 875  |  |     |  |  | 875 |  |  |  |
| Boss                        |  | 875  |  |     |  |  | 875 |  |  |  |
| Mofas drum dia. 110mm       |  | 894  |  |     |  |  | 894 |  |  |  |
| Mofas drum dia. 140mm       |  | 895  |  |     |  |  | 895 |  |  |  |
| 50 Ciclomotori (140mm drum) |  | 895  |  |     |  |  | 895 |  |  |  |

## CCM

|                             |       |         |         |         |     |  |         |         |         |  |
|-----------------------------|-------|---------|---------|---------|-----|--|---------|---------|---------|--|
| CR 40 S Cafe Racer          | 07    | FA95    | FA95HH  |         | N/A |  | FA213   | FA213HH | TBA     |  |
| CR 40 Street                | 07    | FA95    | FA95HH  |         | N/A |  | FA213   | FA213HH | TBA     |  |
| SR 40 Street Scrambler      | 07    | FA194   | FA194HH |         |     |  | FA213   | FA213HH | TBA     |  |
| C-XR 230 E                  | 07    | FA86    | FA86HH  | TBA     |     |  | FA54    | FA54HH  | TBA     |  |
| C-XR 230 S                  | 07    | FA86    | FA86HH  | TBA     |     |  | FA54    | FA54HH  | TBA     |  |
| 404 E                       | 03-04 | FA181TT | FA181R■ | MD6260D |     |  | FA208TT | FA208R■ | MD6276D |  |
| 404 DS                      | 03-04 | FA181TT | FA181R■ | MD6260D |     |  | FA208TT | FA208R■ | MD6276D |  |
| 404 DS Supermoto            | 03-04 | FA181TT | FA181R■ | MD6209D |     |  | FA208TT | FA208R■ | MD6276D |  |
| 604 E DS (Dual Sport/Trail) | 98-03 | FA181TT | FA181R■ | MD6260D |     |  | FA208TT | FA208R■ | MD6276D |  |
| 604E Supermoto              | 99-03 | FA181TT | FA181R■ | MD6209D |     |  | FA208TT | FA208R■ | MD6276D |  |
| 604 RS "Roadster"           | 00-03 | FA181TT | FA181R■ | MD6209D |     |  | FA208TT | FA208R■ | MD6276D |  |

\*-2 Sets Required. ■ - Also available in MX-S race compound, see page 8. ✖ - Oversize and Supermoto disc available - see page 301.

**SAFETY WARNING-** DO NOT USE HH PADS ON REAR UNLESS ALSO USED ON FRONT TO AVOID BRAKE IMBALANCE.



# Non-Japanese Built Motorcycles/Quads



CCM contd.

|                    |       | Front/Avant/Vorn                   |                   |                     | Frente/Anteriore                                     |   | Rear/Arrière/Hinten                |         |                               | Posterior/Posteriore |  |
|--------------------|-------|------------------------------------|-------------------|---------------------|--|---|------------------------------------|---------|-------------------------------|----------------------|--|
|                    |       | 1                                  | 2                 | 3                   | 4  | 5 | 6                                  | 7       | 8                             | 9                    |  |
|                    |       | Sintered/HH Pads/<br>Grooved shoes | Left/Gauche/Links | Right/Droite/Rechts | Contour Rotor<br>Universal left and<br>right fitment |   | Sintered/HH Pads/<br>Grooved shoes |         | Contour Rotor<br>Rear fitment |                      |  |
| 644 DS Supermoto   | 04    | FA181TT                            | FA181R■           | MD6209D             |  |   | FA208TT                            | FA208R■ | MD6276D                       |                      |  |
| 644 DS             | 04    | FA181TT                            | FA181R■           | MD6209D             |  |   | FA208TT                            | FA208R■ | MD6276D                       |                      |  |
| R 30 (Spoke wheel) | 02-04 | FA181TT                            | FA181R■           | MD6209D             |  |   | FA208TT                            | FA208R■ | MD6276D                       |                      |  |
| R 30 (Mag wheel)   | 02-04 | FA181TT                            | FA181R■           | N/A                 |  |   | FA208TT                            | FA208R■ | N/A                           |                      |  |
| R 35/R 35 S        | 06    | FA181TT                            | FA181R■           | TBA                 |  |   | FA208TT                            | FA208R■ | TBA                           |                      |  |

Note: MD6260D = 260mm O/D MD6209D = 320mm O/D.

## C H RACING

|                |    |       |         |     |  |  |       |         |     |  |  |
|----------------|----|-------|---------|-----|--|--|-------|---------|-----|--|--|
| WXE 50 Enduro  | 05 | FA167 | FA167HH | N/A |  |  | FA115 | FA115HH | N/A |  |  |
| WSM 50 Motard  | 05 | FA167 | FA167HH | N/A |  |  | FA115 | FA115HH | N/A |  |  |
| WXE 125 Enduro | 05 | FA167 | FA167HH | N/A |  |  | FA115 | FA115HH | N/A |  |  |
| WSM 125 Motard | 05 | FA167 | FA167HH | N/A |  |  | FA115 | FA115HH | N/A |  |  |

## CIMATTI

|        |     |      |  |     |  |  |     |  |  |  |  |
|--------|-----|------|--|-----|--|--|-----|--|--|--|--|
| Gringo | -85 | FA50 |  | N/A |  |  | N/A |  |  |  |  |
| Gringo | 85- | FA99 |  | N/A |  |  | N/A |  |  |  |  |

## CONTI

|                        |       |       |  |     |  |  |       |  |     |  |  |
|------------------------|-------|-------|--|-----|--|--|-------|--|-----|--|--|
| RX 356 V3 (12" wheels) | 05-06 | FA399 |  | N/A |  |  | FA115 |  | N/A |  |  |
| RX 356 V3 (17" wheels) | 05-06 | FA399 |  | N/A |  |  | FA115 |  | N/A |  |  |

## CPI

|                        |       |         |          |         |     |  |          |         |         |  |  |
|------------------------|-------|---------|----------|---------|-----|--|----------|---------|---------|--|--|
| Argon 50               | 07    | FA235   |          | TBA     |     |  | Y503     |         |         |  |  |
| Argon GP50             | 07    | FA235   |          | TBA     |     |  | Y503     |         |         |  |  |
| Baby J 50              | 02    | FA83TT  | FA83HH   | MD923D  |     |  | Y503     |         |         |  |  |
| Freaky 50              | 07    | FA235   |          | TBA     |     |  | Y503     |         |         |  |  |
| GTR 50/125/200         | 02    | FA194   | FA194HH  | N/A     |     |  | FA260    | FA260HH | N/A     |  |  |
| GTS 50/125/200         | 02-03 | FA194   | FA194HH  | N/A     |     |  | FA260    | FA260HH | N/A     |  |  |
| GTR 50                 | 03-07 | FA266   | FA266HH  | N/A     |     |  | FA260    | FA260HH | N/A     |  |  |
| 50 Hussar              | 01-02 | FA83TT  | FA83HH   | MD923D  |     |  | Y503     |         |         |  |  |
| Hussar 50              | 03-05 | FA235   |          | MD923D  |     |  | Y503     |         |         |  |  |
| 50 Mars                | 01-02 | FA83TT  | FA83HH   | MD923D  |     |  | Y503     |         |         |  |  |
| Oliver 50 (All models) | 03-06 | FA235   |          | MD923D  |     |  | Y503     |         |         |  |  |
| Popcorn 50             | 02    | FA83TT  | FA83HH   | MD923D  |     |  | Y503     |         |         |  |  |
| Popcorn 50             | 03-06 | FA235   |          | MD923D  |     |  | Y504     |         |         |  |  |
| Quad 50/100 cc (Crab)  | 03-04 | H338*   | H338G*   |         |     |  | FA83TT   | FA83R   | N/A     |  |  |
| Supersmoto 50 SMX      | 03-07 | FA115   | FA115R   | N/A     |     |  | FA115    | FA115R  | N/A     |  |  |
| Supercross             | 03-06 | FA115   | FA115R   | N/A     |     |  | FA115    | FA115R  | N/A     |  |  |
| SX 50                  | 06-07 | FA194   | FA194HH  | N/A     |     |  | FA115    | FA115HH | N/A     |  |  |
| XT 50 Quad             | 06    | H338*   | H338G*   |         |     |  | FA165TT  | FA165R  | N/A     |  |  |
| Argon GP 125           | 07    | FA235   |          | TBA     |     |  | Y527     |         |         |  |  |
| 125 Prince             | 01    | FA197   | FA197HH  | N/A     |     |  | TBA      |         |         |  |  |
| Oliver City 125        | 06    | FA235   |          | N/A     |     |  | TBA      |         |         |  |  |
| X-Large 125/150/200    | 02-03 | FA266*  | FA266HH* | N/A     | N/A |  | FA266    | FA266HH | N/A     |  |  |
| Sauel 125              |       | FA185TT | FA185R■  | MD6087D |     |  | FA131TT■ | FA131R■ | MD6013D |  |  |
| XS 250 Quad            | 06-07 | FA377*  | FA377R*  | N/A     | N/A |  | FA165TT  | FA165R  | N/A     |  |  |
| XS 250 Power Quad      | 07    | FA83TT* | FA83R*   | N/A     | N/A |  | FA431TT  | FA431R  | N/A     |  |  |

## CQR

|                |    |         |        |     |     |  |        |       |     |  |  |
|----------------|----|---------|--------|-----|-----|--|--------|-------|-----|--|--|
| DN 50          |    | TBA*    |        |     |     |  | TBA    |       |     |  |  |
| DN 50 E        |    | TBA*    |        |     |     |  | TBA    |       | TBA |  |  |
| DN 50/50 E     | 05 | TBA*    |        |     |     |  | FA83TT | FA83R | N/A |  |  |
| Mini Adventure |    | TBA*    |        |     |     |  | N/A    |       | N/A |  |  |
| DN 100         | 06 | TBA*    |        |     |     |  | FA83TT | FA83R | TBA |  |  |
| DN 100/100 E   | 05 | TBA*    |        |     |     |  | FA83TT | FA83R | N/A |  |  |
| DN 150         |    | TBA*    |        |     |     |  | FA83TT | FA83R | N/A |  |  |
| DN 150 Extreme |    | TBA*    |        |     |     |  | FA83TT | FA83R | TBA |  |  |
| DN 150/150 E   | 05 | TBA*    |        |     |     |  | FA83TT | FA83R | N/A |  |  |
| DN 250/Hammel  | 06 | FA83TT* | FA83R* | N/A | N/A |  | FA83TT | FA83R | N/A |  |  |
| DN 250 Dolphin | 06 | TBA*    |        |     |     |  | FA83TT | FA83R | TBA |  |  |

\*-2 Sets Required. ■ - Also available in MX-S race compound, see page 8. ✖ - Oversize and Supersmoto disc available - see page 301.

**SAFETY WARNING-** DO NOT USE HH PADS ON REAR UNLESS ALSO USED ON FRONT TO AVOID BRAKE IMBALANCE.

R Suffix = High Durability Sintered Pad. HH Suffix = High Performance Sintered Pad. G Suffix = Grooved Shoe.  
D Suffix = Drilled Disc. C Suffix = Contoured Disc. LS Suffix = Left/Steel Disc. RS = Right/Steel Disc.

BRAKE APPLICATIONS

# Non-Japanese Built Motorcycles/Quads

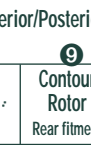

## CQR contd.

|             |    | 1       | 2      | 3   | 4   | 5 | 6      | 7     | 8   | 9 |
|-------------|----|---------|--------|-----|-----|---|--------|-------|-----|---|
| DN 250      | 05 | TBA*    |        |     |     |   | FA83TT | FA83R | N/A |   |
| Utility 250 | 06 | FA83TT* | FA83R* | N/A | N/A |   | FA83TT | FA83R | N/A |   |
| RX 260      | 06 | FA83TT* | FA83R* | N/A | N/A |   | FA83TT | FA83R | N/A |   |

## CSR

|               |       |       |  |     |  |  |       |  |     |  |
|---------------|-------|-------|--|-----|--|--|-------|--|-----|--|
| Ona 125 (4T)  | 04-06 | FA235 |  | N/A |  |  | FA235 |  | N/A |  |
| Scoo 125 (4T) | 04-06 | FA235 |  | N/A |  |  | FA235 |  | N/A |  |

## C.Z./JAWA

|  |       |       |         |     |     |  |       |         |     |  |
|--|-------|-------|---------|-----|-----|--|-------|---------|-----|--|
| 50 Minarelli   | 03-04 | FA115 | FA115HH |     | N/A |  | TBA   |         |     |  |
| 50/100 Robby   | 03-04 | FA115 | FA115HH | N/A |     |  | TBA   |         |     |  |
| Scrambler Cross 125-380 (Single & twin port models)  | 65-76 | 950   |         |     |     |  | 950   |         |     |  |
| 125 Sport  | 03-04 | FA115 | FA115HH |     | N/A |  | FA115 | FA115HH | N/A |  |
| 125 Dandy  | 03-04 | FA115 | FA115HH |     | N/A |  | FA115 | FA115HH | N/A |  |
| 125 Travel   | 03-04 | FA198 |         |     | N/A |  | 949   |         |     |  |
| 125 Chopper  | 03-04 | FA198 |         |     | N/A |  | 949   |         |     |  |
| 125/175/250/350                                      | -74   | 949   |         |     |     |  | 949   |         |     |  |
| 125/175/250/350                                      | 75-   | 951   |         |     |     |  | 949   |         |     |  |
| 250/380 (Models 513/514) Full width front hub models | 77-79 | N/A   |         |     |     |  | 950   |         |     |  |
| Jawa 250/400 Cross                                   | 65-76 | 950   |         |     |     |  | 950   |         |     |  |
| 350  |       | FA198 |         | N/A |     |  | 949   |         |     |  |
| 350 Chopper  | 03-04 | FA198 |         |     | N/A |  | 949   |         |     |  |
| 350 Tramp  | 03-04 | FA198 |         |     | N/A |  | 949   |         |     |  |
| 350 Californian                                      | 03-04 | FA198 |         |     | N/A |  | 949   |         |     |  |
| 350 Californian                                      | 03-04 | FA198 |         |     | N/A |  | 949   |         |     |  |

## DAELIM

|                            |       |         |         |        |     |  |        |         |     |  |
|----------------------------|-------|---------|---------|--------|-----|--|--------|---------|-----|--|
| A-Four (50cc) (SJ 50 R)    | 06-07 | FA264   |         | N/A    |     |  | TBA    |         |     |  |
| Cordi 50/SE 50 R           | 05-07 | FA54TT  | FA54HH  | N/A    |     |  | TBA    |         |     |  |
| DX 50 D Camper             | 03    | FA169   |         | MD904D |     |  | Y503   |         |     |  |
| GZ 50 Message              | 97-02 | FA257   |         | TBA    |     |  | TBA    |         |     |  |
| M 50 D/MD Millenium        | 03    | FA169   |         | MD904D |     |  | Y503   |         |     |  |
| Tapo Message 50            | 04    | FA54TT  | FA54HH  | N/A    |     |  | TBA    |         |     |  |
| E-Five (SJ50A)             | 03-06 | FA257   |         | N/A    |     |  | TBA    |         |     |  |
| 'S' Five (SJ50)            | 01-07 | FA257   |         | TBA    |     |  | TBA    |         |     |  |
| ST 90 Pro Monkey           | 03    | FA169   |         | MD904D |     |  | Y503   |         |     |  |
| Delfino 100 (SH100)        | 01-04 | FA257   |         | TBA    |     |  | TBA    |         |     |  |
| Citi Ace 110               | 03-07 | FA86    | FA86HH  |        | N/A |  | TBA    |         |     |  |
| Altino 125/125 ES          | 01-04 | FA54TT  | FA54HH  |        | N/A |  | TBA    |         |     |  |
| History 125 (SL 125)       | 01-06 | FA54TT  | FA54HH  |        | N/A |  | FA54TT | FA54HH  | N/A |  |
| Otello 125 (NS 125) DLX    | 00-02 | FA54TT  | FA54HH  |        | N/A |  | TBA    |         |     |  |
| Roadwin (VJ125)            | 04-07 | FA196   | FA196HH | N/A    |     |  | FA197  | FA197HH | N/A |  |
| ST 125                     | 03    | FA194   | FA194HH | N/A    |     |  | FA115  | FA115HH | N/A |  |
| VL 125 Daystar/L           | 03-07 | FA196   | FA196HH |        | N/A |  | 824    |         |     |  |
| VS 125 Evolution           | 01-04 | FA196   | FA196HH | N/A    |     |  | TBA    |         |     |  |
| VT 125 Evolution           | 03    | FA196   | FA196HH | N/A    |     |  | TBA    |         |     |  |
| NS 125 DLX/III Trans Eagle | 03-07 | FA54TT  | FA54HH  | N/A    |     |  | FA54TT | FA54HH  | N/A |  |
| SQ 125 Freewing S2         | 06    | FA142   | FA142HH |        |     |  | FA197  | FA197HH | N/A |  |
| ET 250 Quad                | 06    | FA83TT* | FA83R*  | N/A    | N/A |  | FA197  | FA197HH | N/A |  |
| SQ 250 Freeway S2          | 06    | FA142   | FA142HH | N/A    |     |  | FA197  | FA197HH | N/A |  |
| ST 250 Sector Quad         | 05-06 | FA83TT* | FA83R*  | N/A    | N/A |  | FA427  | FA427R  | N/A |  |

## DERBI

|   |           |        |         |        |     |  |       |         |        |  |
|---|-----------|--------|---------|--------|-----|--|-------|---------|--------|--|
| Vamos/Vamos FL                                      | 96-99     | FA115  | FA115HH | N/A    |     |  | S624  |         |        |  |
| Hunter  | 96-99     | FA115  | FA115HH | MD964D |     |  | S624  |         |        |  |
| Atlantis 50 LC/City/Bullet Two Chic (2T) 12" wheels | 02-07     | FA115  | FA115HH | MD964D |     |  | 899   |         |        |  |
| DFW 50 Quad   | 04-07     | H338*  | H338C*  |        |     |  | H330  | H330G   |        |  |
| DRD 50 Supermoto/Racer                              | 03-04     | FA115* | FA115R* | N/A    | N/A |  | FA115 | FA115R  | N/A    |  |
| GP-1 50   | 01-Feb 05 | FA115  | FA115HH | MD991D |     |  | FA115 | FA115HH | MD932D |  |

\*-2 Sets Required. ■ - Also available in MX-S race compound, see page 8. ✖ - Oversize and Supermoto disc available - see page 301.

**SAFETY WARNING-** DO NOT USE HH PADS ON REAR UNLESS ALSO USED ON FRONT TO AVOID BRAKE IMBALANCE.

# Non-Japanese Built Motorcycles/Quads



DERBI contd.

|  |  | Front/Avant/Vorn |                                |                   | Frente/Anteriore    |  | Rear/Arrière/Hinten |                                |         | Posterior/Posteriore       |  |
|--|--|------------------|--------------------------------|-------------------|---------------------|--|---------------------|--------------------------------|---------|----------------------------|--|
|  |  | 1                | 2                              | 3                 | 4                   | 5  | 6                   | 7                              | 8       | 9                          |  |
|  |  |                  | Sintered/HH Pads/Grooved shoes | Left/Gauche/Links | Right/Droite/Rechts | Contour Rotor Universal left and right fitment |                     | Sintered/HH Pads/Grooved shoes |         | Contour Rotor Rear fitment |  |
| GP1 "Scooter" (Radial caliper) "Euro 2"                |  |                  |                                |                   |                     |  |                     |                                |         |                            |  |
| "Chain Drive" Mar 05-Dec 05                            |  | FA266            | FA266HH                        | MD9113D           |                     |  | FA115               | FA115HH                        | TBA     |                            |  |
| GP1 50 "Open" 06-07                                    |  | FA94             | FA94HH                         | MD956D            |                     |  | FA115               | FA115HH                        | MD932D  |                            |  |
| GPR 50-R/Replica 98-03                                 |  | FA167            | FA167HH                        | N/A               |                     |  | FA115               | FA115HH                        | N/A     |                            |  |
| GPR 50/Nude/ST (Radial Caliper) 04-07                  |  | FA266            | FA266HH                        | MD685LS           |                     |  | FA115               | FA115HH                        | MD686   |                            |  |
| Predator/Replica (LC) 98-02                            |  | FA115            | FA115HH                        | MD964D            |                     |  | FA115               | FA115HH                        | MD964D  |                            |  |
| Atlantis 50/100 cc (2T) 99-01                          |  | FA115            | FA115HH                        | MD964D            |                     |  | S624                |                                |         |                            |  |
| Atlantis 50 City/Bullet/Two Chic (4T) 13" wheels 04-07 |  | FA115            | FA115HH                        | MD964D            |                     |  | 816                 |                                |         |                            |  |
| Rambla 50 06   |  | FA350            |                                | TBA               |                     |  | FA350               |                                | TBA     |                            |  |
| Red Bullet 50 04-05                                    |  | FA115            | FA115HH                        | MD964D            |                     |  | S624                |                                |         |                            |  |
| Senda-R 96-99  |  | FA115            | FA115R                         | MD6175D           |                     |  | FA115               | FA115R                         | N/A     |                            |  |
| Senda-R 00-02  |  | FA115            | FA115R                         | MD6250D           |                     |  | FA115               | FA115R                         | MD6248D |                            |  |
| Senda R DRD 04-05                                      |  | FA167            | FA167HH                        | N/A               |                     |  | FA115               | FA115HH                        | MD6248D |                            |  |
| Senda SM DRD Super Motard 04                           |  | FA115*           | FA115HH*                       | N/A               | N/A                 |  | FA115               | FA115HH                        | MD6248D |                            |  |
| Senda 50 DRD Pro SM Supermoto 05-07                    |  | FA266            | FA266HH                        | TBA               |                     |  | FA115               | FA115HH                        | TBA     |                            |  |
| Senda 50 DRD Racing R Enduro 04-07                     |  | FA167            | FA167HH                        | TBA               |                     |  | FA115               | FA115R                         | TBA     |                            |  |
| Senda 50 DRD Racing SM Supermoto 04-07                 |  | FA167            | FA167HH                        | TBA               |                     |  | FA115               | FA115R                         | TBA     |                            |  |
| Senda 50 DRD Pro R Enduro 05-07                        |  | FA266            | FA266HH                        | TBA               |                     |  | FA135               | FA135HH                        | TBA     |                            |  |
| Senda 50 X-Race R Enduro (240mm front disc) 03-07      |  | FA115            | FA115R                         | MD6250D           |                     |  | FA115               | FA115R                         | MD6248D |                            |  |
| Senda 50 X-treme R Enduro (240mm front disc) 03-07     |  | FA115            | FA115R                         | MD6250D           |                     |  | FA115               | FA115R                         | MD6248D |                            |  |
| SM 50 DRD Edition 05                                   |  | FA167            | FA167HH                        | N/A               |                     |  | FA115               | FA115HH                        | N/A     |                            |  |
| Super Motard 01  |  | FA115            | FA115R                         | N/A               |                     |  | FA115               | FA115R                         | MD6248D |                            |  |
| Predator (Air Cooled) 98-01                            |  | FA115            | FA115HH                        | MD964D            |                     |  | S624                |                                |         |                            |  |
| Vamos 50 93-95   |  | S624             |                                |                   |                     |  | S624                |                                |         |                            |  |
| X Race 50 06   |  | FA115            | FA115HH                        | TBA               |                     |  | FA115               | FA115HH                        | TBA     |                            |  |
| GPR 80 Cup Radial Caliper 04-05                        |  | FA266            | FA266HH                        | N/A               |                     |  | FA115               | FA115HH                        | N/A     |                            |  |
| Boulevard 125/200/150 03-07                            |  | FA350            |                                | MD924D            |                     |  | 816                 |                                |         |                            |  |
| Boulevard S 125 07                                     |  | FA256            | FA256HH                        | MD952D            |                     |  | FA298               |                                | MD942D  |                            |  |
| Freexter 125 07  |  | FA399            |                                | MD685LS           |                     |  | FA350               |                                | TBA     |                            |  |
| GPR 125/Nude/ST (Radial caliper) 05-07                 |  | FA399            |                                | MD685LS           |                     |  | FA115               | FA115HH                        | MD686   |                            |  |
| Rambla 125 06  |  | FA350            |                                | TBA               |                     |  | FA350               |                                | TBA     |                            |  |
| Senda R 125 SM 04-07                                   |  | FA194            | FA194HH                        | TBA               |                     |  | FA115               | FA115HH                        | TBA     |                            |  |
| Senda R Euro 2 04-07                                   |  | FA194            | FA194HH                        | TBA               |                     |  | FA115               | FA115HH                        | TBA     |                            |  |
| Senda R Baja Enduro 06-07                              |  | FA194            | FA194HH                        | TBA               |                     |  | FA115               | FA115HH                        | TBA     |                            |  |
| Senda R Baja Supermoto 06-07                           |  | FA194            | FA194HH                        | TBA               |                     |  | FA115               | FA115HH                        | TBA     |                            |  |
| Senda X Race SM Supermoto (260mm front disc) 03-07     |  | FA115            | FA115R                         | TBA               |                     |  | FA115               | FA115R                         | MD6248D |                            |  |
| Senda X-treme SM Supermoto (260mm front disc) 03-07    |  | FA115            | FA115R                         | TBA               |                     |  | FA115               | FA115R                         | MD6248D |                            |  |
| GP 125 06-07   |  | FA266            | FA266HH                        | MD9113D           |                     |  | FA266               | FA266HH                        | MD959D  |                            |  |
| Mulhacen 125 07  |  | FA194            | FA194HH                        | TBA               |                     |  | FA115               | FA115HH                        | TBA     |                            |  |
| Terra 125 07   |  | FA350            |                                | TBA               |                     |  | FA115               | FA115HH                        | TBA     |                            |  |
| GP1 150 05   |  | FA266            | FA266HH                        | MD9113D           |                     |  | FA115               | FA115HH                        | TBA     |                            |  |
| GPX1 06  |  | FA266            | FA266HH                        | TBA               |                     |  | FA115               | FA115HH                        | TBA     |                            |  |
| DXR 200 Quad (Front drum model) 04                     |  | Y503*            | Y503G*                         |                   |                     |  | FA135TT             | FA135R                         | N/A     |                            |  |
| DXR 200 Quad (Front drum model) 04-05                  |  | Y503*            | Y503G*                         |                   |                     |  | FA67TT              | FA67R                          | MD6053D |                            |  |
| DXR 200 Quad (Front disc model) 04-07                  |  | FA83TT*          | FA83R*                         | MD6054D           | MD6054D             |  | FA67TT              | FA67R                          | MD6053D |                            |  |
| DXR 250 Quad (Front drum model) 04-05                  |  | Y503*            | Y503G*                         |                   |                     |  | FA135TT             | FA135R                         | N/A     |                            |  |
| DXR 250 Quad (Front disc model) 04-07                  |  | FA83TT*          | FA83R*                         | MD6054D           | MD6054D             |  | FA67TT              | FA67R                          | MD6053D |                            |  |
| DXR 250 Quad (Front drum model) 04-05                  |  | Y503*            | Y503G*                         |                   |                     |  | FA67TT              | FA67R                          | MD6053D |                            |  |
| GP1 250 06   |  | FA266*           | FA266HH*                       | MD9113D           |                     |  | FA266               | FA266HH                        | MD959D  |                            |  |
| GP1 250 i 07   |  | FA266            | FA266HH                        | MD9113D           |                     |  | FA93                |                                | TBA     |                            |  |
| Mulhacen 659 06-07                                     |  |                  | FA322/4HH                      | TBA               |                     |  | FA266               | FA266HH                        | TBA     |                            |  |
| Mulhacen 659 "Hot Bob" 07                              |  |                  | FA322/4HH                      | TBA               |                     |  | FA266               | FA266HH                        |         |                            |  |
| Mulhacen 659 Cafe 07                                   |  |                  | FA322/4HH                      | TBA               |                     |  | FA266               | FA266HH                        |         |                            |  |
| Mulhacen 659 X Vision 07                               |  |                  | FA322/4HH                      | TBA               |                     |  | FA266               | FA266HH                        |         |                            |  |
| <b>DUCATI</b>  |  |                  |                                |                   |                     |  |                     |                                |         |                            |  |
| 250/350/450 Desmo -76                                  |  | 928              |                                |                   |                     |  | 929                 |                                |         |                            |  |
| 250/350/450 Desmo 74-77                                |  | FA18             | FA18HH                         | MD634LS           |                     |  | 921                 |                                |         |                            |  |
| Supersport 400* 93-97                                  |  | FA95*            | FA95HH*                        | MD2003LS          | MD2003RS            | MD2003C*                                       | FA47                | FA47HH                         | MD2002  | MD2002C                    |  |
| 400 Monster 95-97                                      |  | FA95             | FA95HH                         | MD2003LS          |                     | MD2003C  | FA47                | FA47HH                         | MD2002  | MD2002C                    |  |

\*-2 Sets Required. ■ - Also available in MX-S race compound, see page 8. ✖ - Oversize and Supermoto disc available - see page 301.

**SAFETY WARNING-** DO NOT USE HH PADS ON REAR UNLESS ALSO USED ON FRONT TO AVOID BRAKE IMBALANCE.

R Suffix = High Durability Sintered Pad. G Suffix = Grooved Shoe.  
 D Suffix = Drilled Disc. C Suffix = Contoured Disc. LS Suffix = Left/Steel Disc. RS = Right/Steel Disc.

BRAKE APPLICATIONS

# Non-Japanese Built Motorcycles/Quads



**DUCATI** contd.

|                            |       | Front/Avant/Vorn |                                    |                   | Frente/Anteriore    |  | Rear/Arrière/Hinten |                                    |         | Posterior/Posteriore          |         |
|----------------------------|-------|------------------|------------------------------------|-------------------|---------------------|--|---------------------|------------------------------------|---------|-------------------------------|---------|
|                            |       | 1                | 2                                  | 3                 | 4                   | 5  | 6                   | 7                                  | 8       | 9                             |         |
|                            |       |                  | Sintered/HH Pads/<br>Grooved shoes | Left/Gauche/Links | Right/Droite/Rechts | Contour Rotor<br>Universal left and<br>right fitment |                     | Sintered/HH Pads/<br>Grooved shoes |         | Contour Rotor<br>Rear fitment |         |
| 400 Monster (Japan)        | 00-04 |                  | FA244                              | FA244HH           | MD614LS             |  | MD614C              | FA47                               | FA47HH  | MD2002                        | MD2002C |
| 500 GTL                    | 75    |                  | FA47*                              | FA47HH*           | N/A                 | N/A  |                     | N/A                                |         |                               |         |
| 500 GTV 'Pantah'           | 77    |                  | FA47*                              | FA47HH*           | N/A                 | N/A  |                     | FA47                               | FA47HH  | N/A                           |         |
| 500 Sport Desmo            | 77    |                  | FA47*                              | FA47HH*           | N/A                 | N/A  |                     | FA47                               | FA47HH  |                               |         |
| 500 Pantah                 | 79    |                  | FA47*                              | FA47HH*           | MD657LS             | MD657RS  |                     | FA47                               | FA47HH  | MD657                         |         |
| 600 Pantah                 | 81    |                  | FA18*                              | FA18HH*           | MD657LS             | MD657RS  |                     | FA47                               | FA47HH  | N/A                           |         |
| 600 Monster*               | 93-99 |                  | FA95                               | FA95HH            | MD2003LS            |  | MD2003C             | FA47                               | FA47HH  | MD2002                        | MD2002C |
| 600 Monster Dark           | 98-99 |                  | FA95                               | FA95HH            | MD2003LS            |  | MD2003C             | FA47                               | FA47HH  | MD2002                        | MD2002C |
| 600 Monster City/City Dark | 99    |                  | FA95                               | FA95HH            | MD614LS             |  | MD614C              | FA47                               | FA47HH  | MD2002                        | MD2002C |
| 600 Monster                | 00-01 |                  | FA244                              | FA244HH           | MD614LS             |  | MD614C              | FA47                               | FA47HH  | MD2002                        | MD2002C |
| 600 Supersport*            | 91-97 |                  | FA95                               | FA95HH            | MD2003LS            |  | MD2003C             | FA47                               | FA47HH  | MD2002                        | MD2002C |
| 620 IE/SIE Monster         | 02-04 |                  | FA244*                             | FA244HH*          | MD614LS             | MD614RS  | MD614C*             | FA47                               | FA47HH  | MD2002                        | MD2002C |
| 620 Sport                  | 03    |                  | FA244*                             | FA244HH*          | MD614LS             | MD614RS  | MD614C*             | FA47                               | FA47HH  | MD2002                        | MD2002C |
| Monster 620 Dark           | 03-04 |                  | FA244                              | FA244HH           | MD614LS             |  | MD614C              | FA47                               | FA47HH  | MD2002                        | MD2002C |
| Monster Dark 620           | 05-06 |                  | FA181TT*                           | FA181HH*          | MD626LS             | MD626RS  | MD626C*             | FA47                               | FA47HH  | MD2002                        | MD2002C |
| Monster 620 "Catwoman"     | 05    |                  | FA244*                             | FA244HH*          | MD633LS             | MD633RS  | MD633C*             | FA266                              | FA266HH | MD2002                        | MD2002C |
| Monster 620                | 05-06 |                  | FA181TT*                           | FA181HH*          | MD626LS             | MD626RS  | MD626C*             | FA47                               | FA47HH  | MD2002                        | MD2002C |
| Multistrada 620            | 05-06 |                  | FA181TT*                           | FA181HH*          | MD626LS             | MD626RS  | MD626C*             | FA47                               | FA47HH  | MD2002                        | MD2002C |
| Multistrada 620 Dark       | 05-06 |                  | FA244                              | FA244HH           | TBA                 |  |                     | FA266                              | FA266HH | MD2002                        | MD2002C |
| 650 Pantah                 | -84   |                  | FA18*                              | FA18HH*           | N/A                 | N/A  |                     | FA18                               | FA18HH  | N/A                           |         |
| 695 Monster                | 06-07 |                  | FA181TT*                           | FA181HH*          | MD626LS             | MD626RS  | MD626C*             | FA47                               | FA47HH  | MD627                         | MD627C  |
| 748 SP/Biposto             | 95-98 |                  | FA95*                              | FA95HH*           | MD2003LS            | MD2003RS   | MD2003C*            | FA47                               | FA47HH  | MD632                         | MD632C  |
| 748 Racing/SPS             | 98    |                  | FA244*                             | FA244HH*          | MD2003LS            | MD2003RS   | MD2003C*            | FA47                               | FA47HH  | MD632                         | MD632C  |
| 748 Biposto                | 99    |                  | FA244*                             | FA244HH*          | MD614LS             | MD614RS  | MD614C*             | FA47                               | FA47HH  | MD632                         | MD632C  |
| 748 Racing                 | 99    |                  | FA244*                             | FA244HH*          | MD633LS             | MD633RS  | MD633C*             | FA47                               | FA47HH  | MD632                         | MD632C  |
| 748 SPS                    | 99    |                  | FA244*                             | FA244HH*          | MD2003LS            | MD2003RS   | MD2003C             | FA47                               | FA47HH  | MD632                         | MD632C  |
| 748 Biposto                | 00-02 |                  | FA244*                             | FA244HH*          | MD614LS             | MD614RS  | MD614C*             | FA47                               | FA47HH  | MD632                         | MD632C  |
| 748 R/RS/S                 | 00    |                  | FA244*                             | FA244HH*          | MD633LS             | MD633RS  | MD633C*             | FA47                               | FA47HH  | MD632                         | MD632C  |
| 748 R                      | 01-02 |                  |                                    | FA322/4HH*        | MD636LS             | MD636RS  |                     | FA47                               | FA47HH  | MD632                         |         |
| 748 RS                     | 01    |                  |                                    | FA322/4HH*        | TBA                 | TBA  |                     | FA47                               | FA47HH  | MD632                         |         |
| 748 S                      | 01-02 |                  | FA244*                             | FA244HH*          | MD633LS             | MD633RS  | MD633C*             | FA47                               | FA47HH  | MD632                         | MD632C  |
| 748 Testa Bassa            | 01    |                  | FA244*                             | FA244HH*          | MD614LS             | MD614RS  | MD614C*             | FA47                               | FA47HH  | MD632                         | MD632C  |
| 748 E                      |       |                  | FA244*                             | FA244HH*          | MD614LS             | MD614RS  | MD614C*             | FA47                               | FA47HH  | MD632                         | MD632C  |
| 749/749 S/749 R            | 03-06 |                  |                                    | FA322/4HH*        | MD622LS             | MD622RS  |                     | FA266                              | FA266HH | MD618                         |         |
| 749 Dark                   | 04-06 |                  |                                    | FA322/4HH*        | MD622LS             | MD622RS  |                     | FA266                              | FA266HH | MD618                         |         |
| 750 Sport                  | 74    |                  | FA16                               | FA16HH            | MD634LS             |  |                     | N/A                                |         |                               |         |
| 750 SS                     | 75-76 |                  | FA18                               | FA18HH            | MD634LS             | MD634RS  |                     | FA18                               | FA18HH  | N/A                           |         |
| 751 F1                     | 98    |                  | FA18*                              | FA18HH*           | N/A                 | N/A  |                     | FA18                               | FA18HH  | N/A                           |         |
| 750 Paso                   | 87-90 |                  | FA18*                              | FA18HH*           | MD630LS             | MD630RS  |                     | FA47                               | FA47HH  | MD631                         |         |
| 750 Sport                  | 88-90 |                  | FA18*                              | FA18HH*           | MD630LS             | MD630RS  |                     | FA18                               | FA18HH  | MD631                         |         |
| 750 Supersport*            | 91-98 |                  | FA95                               | FA95HH            | MD2003LS            |  | MD2003C             | FA47                               | FA47HH  | MD2002                        | MD2002C |
| 750 Supersport             | 99    |                  | FA244*                             | FA244HH*          | MD2003LS            | MD2003RS   | MD2003C*            | FA266                              | FA266HH | MD2002                        | MD2002C |
| 750 Supersport IE          | 00-02 |                  | FA244*                             | FA244HH*          | MD614LS             | MD614RS  | MD614C*             | FA266                              | FA266HH | MD2002                        | MD2002C |
| 750 Sport                  | 01-02 |                  | FA244*                             | FA244HH*          | MD614LS             | MD614RS  | MD614C*             | FA266                              | FA266HH | MD2002                        | MD2002C |
| 750 Monster*               | 96-97 |                  | FA95                               | FA95HH            | MD2003LS            |  | MD2003C             | FA47                               | FA47HH  | MD2002                        | MD2002C |
| 750 Monster                | 98    |                  | FA95*                              | FA95HH*           | MD2003LS            | MD2003RS   | MD2003C*            | FA47                               | FA47HH  | MD2002                        | MD2002C |
| 750 Monster City/City Dark | 99    |                  | FA95*                              | FA95HH*           | MD2003LS            | MD2003RS   | MD2003C*            | FA47                               | FA47HH  | MD2002                        | MD2002C |
| 750 Monster/Monster Dark   | 99    |                  | FA95*                              | FA95HH*           | MD2003LS            | MD2003RS   | MD2003C*            | FA47                               | FA47HH  | MD2002                        | MD2002C |
| 750 Monster                | 00-01 |                  | FA244*                             | FA244HH*          | MD614LS             | MD614RS  | MD614C*             | FA47                               | FA47HH  | MD2002                        | MD2002C |
| Monster 800/IE/SIE         | 03-04 |                  | FA244*                             | FA244HH*          | MD614LS             | MD614RS  | MD614C*             | FA47                               | FA47HH  | MD2002                        | MD2002C |
| Monster S2R (803cc)        | 05-07 |                  | FA181TT*                           | FA181HH*          | MD626LS             | MD626RS  | MD626C*             | FA47                               | FA47HH  | MD627                         | MD627C  |
| 800 Sport                  | 03    |                  | FA244*                             | FA244HH*          | MD614LS             | MD614RS  | MD614C*             | FA47                               | FA47HH  | MD2002                        | MD2002C |
| 800 Supersport             | 03-04 |                  | FA244*                             | FA244HH*          | MD614LS             | MD614RS  | MD614C*             | FA266                              | FA266HH | MD2002                        | MD2002C |
| S2R Dark (803cc)           | 06    |                  | FA181TT*                           | FA181HH*          | MD626LS             | MD626RS  | MD626C*             | FA47                               | FA47HH  | MD627                         | MD627C  |
| 851 Superbike Biposto      | 89-92 |                  | FA95*                              | FA95HH*           | MD2003LS            | MD2003RS   | MD2003C*            | FA47                               | FA47HH  | MD2002                        | MD2002C |
| 860 GT/GTS                 | 75-76 |                  | FA18*                              | FA18HH*           | MD634LS             | MD634RS  |                     | FA18                               | FA18HH  | MD634LS                       |         |
| 888 SP4/SP5                | 92-93 |                  | FA95*                              | FA95HH*           | MD2003LS            | MD2003RS   | MD2003C*            | FA47                               | FA47HH  | MD2002                        | MD2002C |
| 888 Superbike Strada       | 94-95 |                  | FA95*                              | FA95HH*           | MD2003LS            | MD2003RS   | MD2003C*            | FA47                               | FA47HH  | MD2002                        | MD2002C |
| 900 GTS                    | 75-76 |                  | FA18*                              | FA18HH*           | MD634LS             | MD634RS  |                     | FA18                               | FA18HH  | MD634LS                       |         |
| 900 SS Darmah              | 76-77 |                  | FA18*                              | FA18HH*           | MD634LS             | MD634RS  |                     | FA18                               | FA18HH  | MD634LS                       |         |

\*-2 Sets Required. ■ - Also available in MX-S race compound, see page 8. ✖ - Oversize and Supermoto disc available - see page 301.

**SAFETY WARNING-** DO NOT USE HH PADS ON REAR UNLESS ALSO USED ON FRONT TO AVOID BRAKE IMBALANCE.

APPLICATIONS

BRAKE

R Suffix = High Durability Sintered Pad. HH Suffix = High Performance Sintered Pad. G Suffix = Grooved Shoe. D Suffix = Drilled Disc. C Suffix = Contoured Disc. LS Suffix = Left/Steel Disc. RS = Right/Steel Disc.

# Non-Japanese Built Motorcycles/Quads



DUCATI contd.

|                                |       | Front/Avant/Vorn                |                                 |                   | Frente/Anteriore    |  | Rear/Arrière/Hinten             |                                 |                            | Posterior/Posteriore |  |
|--------------------------------|-------|---------------------------------|---------------------------------|-------------------|---------------------|--|---------------------------------|---------------------------------|----------------------------|----------------------|--|
|                                |       | 1                               | 2                               | 3                 | 4                   | 5  | 6                               | 7                               | 8                          | 9                    |  |
|                                |       | Sintered/HH Pads/ Grooved shoes | Sintered/HH Pads/ Grooved shoes | Left/Gauche/Links | Right/Droite/Rechts | Contour Rotor Universal left and right fitment | Sintered/HH Pads/ Grooved shoes | Sintered/HH Pads/ Grooved shoes | Contour Rotor Rear fitment |                      |  |
| 900 SS-Darmah                  | 78    | FA18*                           | FA18HH*                         | MD609LS           | MD609RS             |  | FA18                            | FA18HH                          | MD634LS                    |                      |  |
| 900 Hailwood Replica           | 79    | FA18*                           | FA18HH*                         | MD609LS           | MD609RS             |  | FA18                            | FA18HH                          | MD609LS                    |                      |  |
| 900 Supersport                 | 89-90 | FA95*                           | FA95HH*                         | MD2001LS          | MD2001RS            | MD2001C*                                       | FA47                            | FA47HH                          | MD2002                     | MD2002C              |  |
| 900 Supersport/Superlight      | 91-97 | FA95*                           | FA95HH*                         | MD2003LS          | MD2003RS            | MD2003C*                                       | FA47                            | FA47HH                          | MD2002                     | MD2002C              |  |
| 900 Supersport                 | 98-99 | FA244*                          | FA244HH*                        | MD2003LS          | MD2003RS            | MD2003C*                                       | FA266                           | FA266HH                         | MD2002                     | MD2002C              |  |
| 900 Supersport CR USA          | 98    | FA95*                           | FA95HH*                         | MD2003LS          | MD2003RS            | MD2003C*                                       | FA47                            | FA47HH                          | MD2002                     | MD2002C              |  |
| 900 Supersport FE              | 98    | FA95*                           | FA95HH*                         | MD2003LS          | MD2003RS            | MD2003C*                                       | FA47                            | FA47HH                          | MD2002                     | MD2002C              |  |
| 900 Supersport IE              | 00-01 | FA244*                          | FA244HH*                        | MD614LS           | MD614RS             | MD614C*  | FA266                           | FA266HH                         | MD2002                     | MD2002C              |  |
| 900 Sport                      | 02    | FA244*                          | FA244HH*                        | MD614LS           | MD614RS             | MD614C*  | FA266                           | FA266HH                         | MD2002                     | MD2002C              |  |
| 900 Monster                    | 93-99 | FA95*                           | FA95HH*                         | MD2003LS          | MD2003RS            | MD2003C*                                       | FA47                            | FA47HH                          | MD2002                     | MD2002C              |  |
| 900 Monster Cromo/Special      | 98    | FA95*                           | FA95HH*                         | MD2003LS          | MD2003RS            | MD2003C*                                       | FA47                            | FA47HH                          | MD2002                     | MD2002C              |  |
| 900 Monster City/City Dark     | 99    | FA95*                           | FA95HH*                         | MD2003LS          | MD2003RS            | MD2003C*                                       | FA47                            | FA47HH                          | MD2002                     | MD2002C              |  |
| 900 IE Monster                 | 00-01 | FA244*                          | FA244HH*                        | MD614LS           | MD614RS             | MD614C*  | FA47                            | FA47HH                          | MD2002                     | MD2002C              |  |
| 900 MH Evoluzione              | 00-01 | FA244*                          | FA244HH*                        | MD614LS           | MD614RS             | MD614C*  | FA266                           | FA266HH                         | MD632                      | MD632C               |  |
| 906 Paso                       | 88-89 | FA18*                           | FA18HH*                         | TBA               | TBA                 |  | FA18                            | FA18HH                          | MD631                      |                      |  |
| 907 IE                         | 90-91 | FA95*                           | FA95HH*                         | MD2001LS          | MD2001RS            | MD2001C*                                       | FA47                            | FA47HH                          | MD2002                     | MD2002C              |  |
| 907 IE                         | 92-93 | FA95*                           | FA95HH*                         | MD2003LS          | MD2003RS            | MD2003C*                                       | FA47                            | FA47HH                          | MD2002                     | MD2002C              |  |
| 916 SP                         | 94-96 | FA95*                           | FA95HH*                         | MD2003LS          | MD2003RS            | MD2003C*                                       | FA47                            | FA47HH                          | MD632                      | MD632C               |  |
| 916 Biposto-Senna              | 94-98 | FA95*                           | FA95HH*                         | MD2003LS          | MD2003RS            | MD2003C*                                       | FA47                            | FA47HH                          | MD632                      | MD632C               |  |
| 916 Racing (996cc)             | 98    | FA95*                           | FA95HH*                         | N/A               | N/A                 |  | N/A                             | N/A                             |                            |                      |  |
| 916 SPS (996cc)                | 98    | FA244*                          | FA244HH*                        | MD2003LS          | MD2003RS            | MD2003C*                                       | FA47                            | FA47HH                          | MD632                      | MD632C               |  |
| Sport Touring ST4-916cc        | 99-03 | FA244*                          | FA244HH*                        | MD614LS           | MD614RS             | MD614C*  | FA266                           | FA266HH                         | MD2002                     | MD2002C              |  |
| Monster S4/S4 (Foggy) (916)    | 01-02 | FA244*                          | FA244HH*                        | MD633LS           | MD633RS             | MD633C*  | FA47                            | FA47HH                          | MD2002                     | MD2002C              |  |
| Sport Touring ST2-944cc        | 97-02 | FA244*                          | FA244HH*                        | MD614LS           | MD614RS             | MD614C*  | FA266                           | FA266HH                         | MD2002                     | MD2002C              |  |
| Desmosedici RR (D16RR) (989cc) | 07    |                                 | FA447HH*                        | TBA               | TBA                 |  | FA266                           | FA266HH                         | MD618                      |                      |  |
| Classic Sport Biposto (992cc)  | 07    | FA181TT*                        | FA181HH*                        | MD614LS           | MD614RS             | MD614C*  | FA213                           | FA213HH                         | MD2002                     | MD2002C              |  |
| 1000 Sport (992cc)             | 06-07 | FA181TT*                        | FA181HH*                        | MD614LS           | MD614RS             | MD614C*  | FA213                           | FA213HH                         | MD2002                     | MD2002C              |  |
| ST3S (ABS Model)               | 06-07 | FA244*                          | FA244HH*                        | MD624LS           | MD633RS             |  | FA266                           | FA266HH                         | MD2002                     |                      |  |
| STS 3 (992cc)                  | 04-06 | FA244*                          | FA244HH*                        | MD614LS           | MD614RS             | MD614C*  | FA266                           | FA266HH                         | MD2002                     | MD2002C              |  |
| S2R (992cc)                    | 06-07 | FA244*                          | FA244HH*                        | MD614LS           | MD614RS             | MD614C*  | FA47                            | FA47HH                          | MD627                      | MD627C               |  |
| 996                            | 98    | FA244*                          | FA244HH*                        | MD2003LS          | MD2003RS            | MD2003C*                                       | FA47                            | FA47HH                          | MD632                      | MD632C               |  |
| 996 Racing                     | 99    | FA95                            | FA95HH                          | N/A               | N/A                 |  | N/A                             | N/A                             |                            |                      |  |
| 996 SPS/SPS II                 | 99-00 | FA244*                          | FA244HH*                        | MD633LS           | MD633RS             | MD633C*  | FA47                            | FA47HH                          | MD632                      | MD632C               |  |
| 996                            | 00    | FA244*                          | FA244HH*                        | MD633LS           | MD633RS             | MD633C*  | FA47                            | FA47HH                          | MD632                      | MD632C               |  |
| 996 RS                         | 00    | N/A                             | N/A                             | N/A               | N/A                 |  | N/A                             | N/A                             |                            |                      |  |
| 996 S                          | 01    | FA244*                          | FA244HH*                        | MD2003LS          | MD2003RS            | MD2003C*                                       | FA47                            | FA47HH                          | MD632                      | MD632C               |  |
| Monster S4R (996cc)            | 03-06 | FA244*                          | FA244HH*                        | MD633LS           | MD633RS             | MD633C*  | FA266                           | FA266HH                         | MD627                      | MD627C               |  |
| Sport Touring ST4S 996cc       | 01-05 | FA244*                          | FA244HH*                        | MD633LS           | MD633RS             | MD633C*  | FA266                           | FA266HH                         | MD2002                     | MD2002C              |  |
| Sport Touring 996cc ST4S-ABS   | 03-05 | FA244*                          | FA244HH*                        | MD624LS           | MD633RS             | MD633C*  | FA266                           | FA266HH                         | MD2002                     | MD2002C              |  |
| 998 S                          | 02    |                                 | FA322/4HH*                      | MD636LS           | MD636RS             |  | FA47                            | FA47HH                          | MD632                      |                      |  |
| 998 R                          | 02    |                                 | FA322/4HH*                      | MD2003LS          | MD2003RS            | MD2003C*                                       | FA47                            | FA47HH                          | MD632                      | MD632C               |  |
| 998                            | 02-03 | FA244*                          | FA244HH*                        | MD636LS           | MD636RS             |  | FA47                            | FA47HH                          | MD632                      |                      |  |
| S4RS (998cc) Testastretta      | 06-07 |                                 | FA322/4HH*                      | TBA               | TBA                 |  | FA47                            | FA47HH                          | MD627                      |                      |  |
| S4R (998cc) Testastretta       | 07    |                                 | FA322/4HH*                      | TBA               | TBA                 |  | FA47                            | FA47HH                          | MD627                      |                      |  |
| 999/999 S/999 R                | 03-05 |                                 | FA322/4HH*                      | MD622LS           | MD622RS             |  | FA266                           | FA266HH                         | MD618                      |                      |  |
| 999 R (Xerox)                  | 06    |                                 | FA322/4HH*                      | MD622LS           | MD622RS             |  | FA266                           | FA266HH                         | MD618                      |                      |  |
| Multi Strada 1000 DS/1000 S DS | 03-06 | FA244*                          | FA244HH*                        | MD682LS           | MD682RS             |  | FA266                           | FA266HH                         | MD627                      |                      |  |
| 1000 R1 Hailwood Replica       | 84    | FA18*                           | FA18HH*                         | MD609LS           | MD609RS             |  | FA18                            | FA18HH                          | MD609LS                    |                      |  |
| 1000 Supersport DS (992cc)     | 03-06 | FA244*                          | FA244HH*                        | MD614LS           | MD614RS             | MD614C*  | FA266                           | FA266HH                         | MD2002                     | MD2002C              |  |
| GT 1000 Sport (992cc)          | 06-07 | FA181TT*                        | FA181HH*                        | MD614LS           | MD614RS             | MD614C*  | FA213                           | FA213HH                         | MD2002                     | MD2002C              |  |
| Monster 1000 IE/SIE            | 03-05 | FA244*                          | FA244HH*                        | MD614LS           | MD614RS             | MD614C*  | FA47                            | FA47HH                          | MD2002                     | MD2002C              |  |
| Paul Smart 1000 Limited        | 06    | FA181TT*                        | FA181HH*                        | MD614LS           | MD614RS             | MD614C*  | FA213                           | FA213HH                         | MD2002                     | MD2002C              |  |
| Sport 1000 S (992cc)           | 07    | FA181TT*                        | FA181HH*                        | MD614LS           | MD614RS             | MD614C*  | FA213                           | FA213HH                         | MD2002                     | MD2002C              |  |
| 1098                           | 07    |                                 | FA447HH*                        | MD694LS           | MD694RS             | MD694C*  | FA266                           | FA266HH                         | MD695                      | MD695C               |  |
| 1098 S                         | 07    |                                 | FA447HH*                        | MD694LS           | MD694RS             | MD694C*  | FA266                           | FA266HH                         | MD695                      | MD695C               |  |
| 1098 Tricolore                 | 07    |                                 | FA447HH*                        | MD694LS           | MD694RS             | MD694C*  | FA266                           | FA266HH                         | MD695                      | MD695C               |  |
| Multistrada 1100 (1078cc)      | 07    | FA244*                          | FA244HH*                        | MD682LS           | MD682RS             |  | FA266                           | FA266HH                         | MD627                      |                      |  |
| Multistrada 1100 S (1078cc)    | 07    | FA244*                          | FA244HH*                        | MD682LS           | MD682RS             |  | FA266                           | FA266HH                         | MD627                      |                      |  |

\*Note - choice of either single or twin front rotor fitment

\*-2 Sets Required. ■ - Also available in MX-S race compound, see page 8. ✖ - Oversize and Supermoto disc available - see page 301.

**SAFETY WARNING-** DO NOT USE HH PADS ON REAR UNLESS ALSO USED ON FRONT TO AVOID BRAKE IMBALANCE.

R Suffix = High Durability Sintered Pad. HH Suffix = High Performance Sintered Pad. G Suffix = Grooved Shoe.

D Suffix = Drilled Disc. C Suffix = Contoured Disc. LS Suffix = Left/Steel Disc. RS = Right/Steel Disc.

BRAKE APPLICATIONS

# Non-Japanese Built Motorcycles/Quads



| Front/Avant/Vorn               |                   |                     | Frente/Anteriore |                                  |                                | Rear/Arrière/Hinten |               |               | Posterior/Posteriore |  |  |
|--------------------------------|-------------------|---------------------|------------------|----------------------------------|--------------------------------|---------------------|---------------|---------------|----------------------|--|--|
| 1                              | 2                 | 3                   | 4                | 5                                | 6                              | 7                   | 8             | 9             |                      |  |  |
| Sintered/HH Pads/Grooved shoes | Left/Gauche/Links | Right/Droite/Rechts | Contour Rotor    | Universal left and right fitment | Sintered/HH Pads/Grooved shoes | Contour Rotor       | Contour Rotor | Contour Rotor |                      |  |  |

## EASY RIDER

|                         |    |      |     |  |  |      |  |  |
|-------------------------|----|------|-----|--|--|------|--|--|
| CJ 50 F                 | 98 | TBA  |     |  |  | TBA  |  |  |
| Teeny Blazer/II         | 98 | TBA  |     |  |  | TBA  |  |  |
| QM 50 E                 | 98 | TBA  |     |  |  | TBA  |  |  |
| M 50 "Monkey/Monkey O.R | 98 | H303 |     |  |  | H303 |  |  |
| CJ 70 Holiday           | 98 | TBA  |     |  |  | TBA  |  |  |
| JH 125 L "Trail Blazer" | 98 | TBA  |     |  |  | TBA  |  |  |
| JC 125/8 "Dragon"       | 98 | FA93 | N/A |  |  | TBA  |  |  |

## ECO

|                         |  |         |     |  |  |         |     |  |
|-------------------------|--|---------|-----|--|--|---------|-----|--|
| Bushman 150 (LX 150 GY) |  | FA135TT | N/A |  |  | FA115TT | N/A |  |
|-------------------------|--|---------|-----|--|--|---------|-----|--|

## ELSTARS

|   |  |       |     |  |  |       |     |  |
|---|--|-------|-----|--|--|-------|-----|--|
| Various models (Check parts before fitting) |  | FA448 | N/A |  |  | FA448 | N/A |  |
|---|--|-------|-----|--|--|-------|-----|--|

## E-TON

|   |       |         |        |     |     |         |        |     |
|---|-------|---------|--------|-----|-----|---------|--------|-----|
| IXL 40 Rascal                           | 98-01 | N/A     |        |     |     | H330    | H330G  |     |
| RXL-40E Viper Junior                    | 01-07 | N/A     |        |     |     | H330    | H330G  |     |
| Viper 40 E                              | 99-00 | N/A     |        |     |     | H330    | H330G  |     |
| AXL-50 Lightning 50                     | 99-00 | H338*   | H338G* |     |     |         |        |     |
| BXL-50 Draco                            | 05-06 | H338*   | H338G* |     |     | FA83TT  | FA83R  | N/A |
| EXL 50 Viper 50                         | 907   | H338*   | H338G* |     |     | FA83TT  | FA83R  | TBA |
| NXL 50 Lightning 50                     | 01-02 | H338*   | H338G* |     |     | TBA     |        |     |
| TXL 50 Wizz 50                          | 98-99 | H338*   | H338G* |     |     | TBA     |        |     |
| Viper 50 Mini RXL 50M                   | 03-07 | N/A     |        |     |     | FA83TT  | FA83R  | N/A |
| Viper 50 RXL 50                         | 03-07 | N/A     |        |     |     | FA83TT  | FA83R  | N/A |
| Viper 70 RLX 70                         | 05-07 | H338    | H338G  |     |     | FA83TT  | FA83R  | N/A |
| AXL 90 Thunder                          | 99-00 | H338    | H338G  |     |     | H330    | H330G  |     |
| DXL-90 Sierra                           | 99-03 | S614*   | S614G* |     |     | H330    | H330G  |     |
| NXL-90 Thunder                          | 01-02 | H338*   | H338G* |     |     | H330    | H330G  |     |
| RXL 90 Viper 90                         | 03-07 | H338*   | H338G* |     |     | FA83TT  | FA83R  | N/A |
| RXL 90 R Viper 90 R Reverse             | 03-07 | H338*   | H338G* |     |     | FA83TT  | FA83R  | N/A |
| BXL 100 Draco                           | 05-06 | H338*   | H338G* |     |     | FA83TT  | FA83R  | N/A |
| CXL 150 Challenger (Rear disc)          | 02-07 | H303*   | H303G* |     |     | FA165TT | FA165R | N/A |
| CXL 150 Challenger (Drum brake model)   | 02-07 | H303*   | H303G* |     |     | H330    | H330G  |     |
| EXL 150 Yukon S.T. (Rear drum)          | 05-07 | FA83TT* | FA83R* | N/A | N/A | H330    | H330G  |     |
| EXL 150 Eukon ST (Drum front/disc rear) | 05-07 | S614*   | S614G* |     |     | FA165TT | FA165R | TBA |
| RXL 150 Viper                           | 05-06 | H303*   | H303G* |     |     | FA165TT | FA165R | N/A |
| RXL 150 Viper                           | 07    | H303*   | H303G* |     |     | FA427   | FA427R | TBA |
| Viper EXL 150 ST Quad                   | 05-07 | FA83TT* | FA83R* | N/A | N/A | H330    | H330G  |     |
| YXL 150 Yukon                           | 00-02 | H303*   | H303G* |     |     | H330    | H330G  |     |
| RXL 150 Viper R                         | 05    | H303*   | H303G* |     |     | FA165TT | FA165R | N/A |
| VXL 250 ST Vector                       | 06-07 | FA83TT* | FA83R* | N/A | N/A | FA427   | FA427R | N/A |
| VXL Vector 250                          | 06-07 | FA83TT* | FA83R* | N/A | N/A | FA427   | FA427R | N/A |
| VXL 300 Vector                          | 07    | FA83TT* | FA83R* | TBA | TBA | FA427   | FA427R | TBA |
| VXL 300 ST Vector ST                    | 07    | FA83TT* | FA83R* | TBA | TBA | FA427   | FA427R | TBA |
| VTX 300 Vortex                          | 07    | FA83TT* | FA83R* | TBA | TBA | FA427   | FA427R | TBA |
| VTX 300 ST Vortex ST                    | 07    | FA83TT* | FA83R* | TBA | TBA | FA427   | FA427R | TBA |

## EXPLORER

|         |    |       |         |     |  |       |         |     |
|---------|----|-------|---------|-----|--|-------|---------|-----|
| KBR 200 | 05 | FA167 | FA167HH | N/A |  | FA115 | FA115HH | N/A |
|---------|----|-------|---------|-----|--|-------|---------|-----|

## FACTORY

|                  |       |         |         |     |  |         |         |     |
|------------------|-------|---------|---------|-----|--|---------|---------|-----|
| Chrono SM 50     | 04    | FA194   | FA194HH | N/A |  | FA115   | FA115HH | N/A |
| Phantom R14 Agua | 04    | FA351   |         | N/A |  | FA115   |         | N/A |
| RP 5-            | 05    | FA194   | FA194HH | N/A |  | FA115   | FA115HH | N/A |
| YM 50            | 05    | FA194   | FA194HH | N/A |  | FA115   | FA115HH | N/A |
| YR 50 Desert     | 02-03 | FA115   | FA115HH | N/A |  | FA115   | FA115HH | N/A |
| YR 50 Desert     | 04-05 | FA194   | FA194HH | N/A |  | FA115   | FA115HH | N/A |
| YR 125 4T        | 05    | FA194   | FA194HH | N/A |  | FA115   | FA115HH | N/A |
| YR 250 Desert    | 03    | FA181TT | FA181R  | N/A |  | FA208TT | FA208R  | N/A |

\*-2 Sets Required. ■ - Also available in MX-S race compound, see page 8. ✖ - Oversize and Supermoto disc available - see page 301.

**SAFETY WARNING-** DO NOT USE HH PADS ON REAR UNLESS ALSO USED ON FRONT TO AVOID BRAKE IMBALANCE.

R Suffix = High Durability Sintered Pad.

HH Suffix = High Performance Sintered Pad.

G Suffix = Grooved Shoe.

D Suffix = Drilled Disc. C Suffix = Contoured Disc. LS Suffix = Left/Steel Disc. RS = Right/Steel Disc.

# Non-Japanese Built Motorcycles/Quads



## FANTIC

|                                  |       | Front/Avant/Vorn |                                |                   | Frente/Anteriore    |  | Rear/Arrière/Hinten |                                |     | Posterior/Posteriore       |  |
|----------------------------------|-------|------------------|--------------------------------|-------------------|---------------------|--|---------------------|--------------------------------|-----|----------------------------|--|
|                                  |       | 1                | 2                              | 3                 | 4                   | 5  | 6                   | 7                              | 8   | 9                          |  |
|                                  |       |                  | Sintered/HH Pads/Grooved shoes | Left/Gauche/Links | Right/Droite/Rechts | Contour Rotor Universal left and right fitment |                     | Sintered/HH Pads/Grooved shoes |     | Contour Rotor Rear fitment |  |
| 50 Issimo spoke wheel            |       | 945              |                                |                   |                     |  | 945                 |                                |     |                            |  |
| 50 Issimo Alu wheel              |       | 945              |                                |                   |                     |  | 945                 |                                |     |                            |  |
| 50 Trial                         | -83   |                  | 926WG                          |                   |                     |  |                     | 922WG                          |     |                            |  |
| 50 Strada Super Six              | 73-   | FA50             |                                | N/A               |                     |  |                     | 843WG                          |     |                            |  |
| 50 Strada                        | -82   | 841              |                                |                   |                     |  |                     | 841WG                          |     |                            |  |
| 50 Strada                        | 82-   | FA67/2           |                                | N/A               |                     |  |                     | 843WG                          |     |                            |  |
| 50 Repl./Enduro Repl.            | -85   |                  | 841WG                          |                   |                     |  |                     | 841WG                          |     |                            |  |
| 50 Enduro Competition            | -82   |                  | 841WG                          |                   |                     |  |                     | 841WG                          |     |                            |  |
| 50 Enduro                        | 83-   |                  | 922WG                          |                   |                     |  |                     | 922WG                          |     |                            |  |
| 50 Sprinter/3V.R                 | 83-   | 909              |                                |                   |                     |  | 909                 |                                |     |                            |  |
| 50 Casal/Competition             | 75-   |                  | 841WG                          |                   |                     |  |                     | 841WG                          |     |                            |  |
| 50 Caballero                     | -83   |                  | 922WG                          |                   |                     |  |                     | 922WG                          |     |                            |  |
| 50 Caballero/Caballero RC        | 91-   | FA47             | FA47R                          | N/A               |                     |  | FA60                |                                | N/A |                            |  |
| 50/50.1 Raider                   | 81-   | FA67/2           |                                | N/A               |                     |  | 930                 |                                |     |                            |  |
| 50.1 Oasis                       | 86-   | FA116            |                                | N/A               |                     |  | FA60                |                                | N/A |                            |  |
| 50.1 Oasis KSI/Rally             | 86-   | FA116            |                                | N/A               |                     |  |                     | 930WG                          |     |                            |  |
| 50.1 Oasis E.S.                  | 87-   | FA116            |                                | N/A               |                     |  | FA60                |                                | N/A |                            |  |
| 50.1 Oasis Kick                  | 87-   | FA99             |                                | N/A               |                     |  |                     | 995WG                          |     |                            |  |
| 50.1 Trial                       | 86-   | FA99             |                                | N/A               |                     |  |                     | 930WG                          |     |                            |  |
| 50.1 Trial H 20                  | 87-   | FA99             |                                | N/A               |                     |  |                     | 995WG                          |     |                            |  |
| 50.5 Trial                       | 89    | FA115            | FA115R                         | N/A               |                     |  | FA115               | FA115R                         | N/A |                            |  |
| 50.7 Trial                       | 90    | FA115            | FA115R                         | N/A               |                     |  | FA115               | FA115R                         | N/A |                            |  |
| 50.9 Trial                       | 91-   | FA115            | FA115R                         | N/A               |                     |  | FA115               | FA115R                         | N/A |                            |  |
| 50 Fast                          | 88-   | FA116            |                                | N/A               |                     |  |                     | 841WG                          |     |                            |  |
| 50 Joy                           | 92-   | 945              |                                |                   |                     |  | 945                 |                                |     |                            |  |
| 50 Kaloa                         |       | FA60             |                                | N/A               |                     |  | FA60                |                                | N/A |                            |  |
| 50 Clubman                       | 95-   | FA115            | FA115R                         | N/A               |                     |  | FA115               | FA115R                         | N/A |                            |  |
| Trial 50 Junior                  | 87-   |                  | 930G                           |                   |                     |  |                     | 930G                           |     |                            |  |
| Trial 50                         | 06    | FA291            |                                | N/A               |                     |  | FA291               |                                | N/A |                            |  |
| 80 Trial                         | -83   |                  | 922WG                          |                   |                     |  |                     | 922WG                          |     |                            |  |
| 80 Trial                         | 83-   |                  | 930WG                          |                   |                     |  |                     | 930WG                          |     |                            |  |
| 80 Enduro                        | 80-   |                  | 841WG                          |                   |                     |  |                     | 843WG                          |     |                            |  |
| 80 Caballero/Caballero RC        | 91-   | FA47             | FA47R                          | N/A               |                     |  | FA60                |                                | N/A |                            |  |
| 80 Cross Compet.                 | -81   |                  | 841WG                          |                   |                     |  |                     | 841WG                          |     |                            |  |
| 80 Cross Compet.                 | 81-   |                  | 841WG                          |                   |                     |  |                     | 843WG                          |     |                            |  |
| 80 Kaloa                         |       | FA60             |                                | N/A               |                     |  | FA60                |                                |     |                            |  |
| 80 Clubman                       | 95-   | FA115            | FA115R                         | N/A               |                     |  | FA115               | FA115R                         |     |                            |  |
| Trial 125                        |       |                  | 841G                           |                   |                     |  | 841G                |                                |     |                            |  |
| Trial 125/2                      |       | FA99             | FA99R                          | N/A               |                     |  | FA99                | FA99R                          | N/A |                            |  |
| Section 125/249 R                | -95   | FA115            | FA115R                         | N/A               |                     |  | FA115               | FA115R                         | N/A |                            |  |
| 200                              |       |                  | 841G                           |                   |                     |  |                     | 841G                           |     |                            |  |
| 201 Monoshock                    | 86    | FA99             | FA99R                          | N/A               |                     |  |                     | 841G                           |     |                            |  |
| 240                              |       |                  | 841G                           |                   |                     |  |                     | 841G                           |     |                            |  |
| Trial 243                        | 87-   | FA99             | FA99R                          | N/A               |                     |  | FA99                | FA99R                          | N/A |                            |  |
| 300 Trial                        |       |                  | 939G                           |                   |                     |  |                     | 841G                           |     |                            |  |
| 301 Monoshock                    | 86    | FA99             | FA99R                          | N/A               |                     |  |                     | 841G                           |     |                            |  |
| 303 Monoshock                    | 87    | FA99             | FA99R                          | N/A               |                     |  | FA99                | FA99R                          | N/A |                            |  |
| 125.5/245/305                    | 89    | FA115            | FA115R                         | N/A               |                     |  | FA115               | FA115R                         | N/A |                            |  |
| All series 7 models              | 90    | FA115            | FA115R                         | N/A               |                     |  | FA115               | FA115R                         | N/A |                            |  |
| 309                              | 92    | FA115            | FA115R                         | N/A               |                     |  | FA115               | FA115R                         | N/A |                            |  |
| K-R00 All Models                 | 92-95 | FA115            | FA115R                         | N/A               |                     |  | FA115               | FA115R                         | N/A |                            |  |
| Section 125/249 R                | 95-   | FA115            | FA115R                         | N/A               |                     |  | FA115               | FA115R                         | N/A |                            |  |
| <b>FAST TOYS (SEE QUADZILLA)</b> |       |                  |                                |                   |                     |  |                     |                                |     |                            |  |
| <b>FB MINARELLI (SPAIN)</b>      |       |                  |                                |                   |                     |  |                     |                                |     |                            |  |
| Rieju Marathon                   | 74-   | 985              |                                |                   |                     |  | 985                 |                                |     |                            |  |
| MR 80                            |       | FA115            | FA115R                         | N/A               |                     |  |                     | 936WG                          |     |                            |  |

\*-2 Sets Required. ■ - Also available in MX-S race compound, see page 8. ✖ - Oversize and Supermoto disc available - see page 301.

**SAFETY WARNING-** DO NOT USE HH PADS ON REAR UNLESS ALSO USED ON FRONT TO AVOID BRAKE IMBALANCE.

**R** Suffix = High Durability Sintered Pad. **HH** Suffix = High Performance Sintered Pad. **G** Suffix = Grooved Shoe.  
**D** Suffix = Drilled Disc. **C** Suffix = Contoured Disc. **LS** Suffix = Left/Steel Disc. **RS** = Right/Steel Disc.

**BRAKE APPLICATIONS**

# Non-Japanese Built Motorcycles/Quads



Front/Avant/Vorn



Frente/Anteriore

Rear/Arrière/Hinten



Posterior/Posteriore

1

2

3

4

5

6

7

8

9

## FONTA

|           |    | 1   | 2 | 3   | 4 | 5 | 6   | 7 | 8   | 9 |
|-----------|----|-----|---|-----|---|---|-----|---|-----|---|
| Hawk 50   | 06 | TBA |   | TBA |   |   | TBA |   | TBA |   |
| FK 125/17 | 06 | TBA |   | TBA |   |   | TBA |   |     |   |
| FT 125-T  | 06 | TBA |   | TBA |   |   | TBA |   |     |   |

## FYM/X-SPORT

|                                  |       |        |          |     |     |  |       |         |     |  |
|----------------------------------|-------|--------|----------|-----|-----|--|-------|---------|-----|--|
| Mini-X RC 50 F                   | 06    | N/A    |          |     |     |  | N/A   |         |     |  |
| CR 90 E                          | 06-07 | FA169  | FA169HH  | N/A |     |  | H338  | H338G   |     |  |
| Xtreme CR90E Auto                | 06    | TBA    |          | N/A |     |  | N/A   |         |     |  |
| 110 ES R X-Sport                 | 06-07 | FA169  | FA169HH  | N/A |     |  | FA115 | FA115HH | N/A |  |
| 110 ES                           | 06-07 | FA169  | FA169HH  | N/A |     |  | H338  | H338G   |     |  |
| CR 110 X Sport 110               | 06-07 | TBA    |          | N/A |     |  | TBA   |         | N/A |  |
| CR 110                           | 06-07 | FA169  | FA169HH  | N/A |     |  | FA115 | FA115HH | N/A |  |
| CR 110 ESR                       | 06-07 | FA169  | FA169HH  | N/A |     |  | FA115 | FA115HH | N/A |  |
| X-Sport 110                      | 06    | TBA    |          | N/A |     |  | TBA   |         | N/A |  |
| X-Sport CR3                      | 06    | TBA    |          | N/A |     |  | FA115 | FA115HH | N/A |  |
| X-Sport Sand Blaster             | 06    | TBA    |          | N/A |     |  | TBA   |         | N/A |  |
| CR 125 Sand Bike                 | 06-07 | TBA    |          |     |     |  | TBA   |         |     |  |
| CR 125 R                         | 06-07 | FA169  | FA169HH  | N/A |     |  | FA115 | FA115HH | N/A |  |
| CR 3 125                         | 06-07 | FA169  | FA169HH  | N/A |     |  | FA115 | FA115HH | N/A |  |
| FYM 125 EY-5 (X Sport CR3/CR125) | 06-07 | FA169  | FA169HH  | N/A |     |  | FA115 | FA115HH | N/A |  |
| X-Sport Typhoon 125 Quad         | 06-07 | FA169* | FA169HH* | N/A | N/A |  | FA115 | FA115HH | N/A |  |
| X-Trail 150                      | 06-07 | TBA    |          | N/A |     |  | TBA   |         | N/A |  |

## GARELLI

|                                     |     |        |         |        |  |     |       |         |     |  |
|-------------------------------------|-----|--------|---------|--------|--|-----|-------|---------|-----|--|
| Queenie                             | 95- | FA83TT | FA83HH  | MD904D |  |     | Y503  |         |     |  |
| Grinta                              | 95- | FA83TT | FA83HH  | MD904D |  |     | Y503  |         |     |  |
| Capri 50/LX 50                      | 07  | FA169  | FA169HH | TBA    |  |     | TBA   |         |     |  |
| Ciclone 50                          | 07  | FA169  | FA169HH | TBA    |  |     | TBA   |         |     |  |
| FLO 50                              |     | FA193  | FA193HH | MD916D |  |     | TBA   |         |     |  |
| FX 50                               |     | FA169  | FA169HH | MD923D |  |     | Y503  |         |     |  |
| KRS 50                              |     | FA264  |         | MD923D |  |     | S624  |         |     |  |
| VIP 50                              |     | TBA    |         |        |  |     | TBA   |         |     |  |
| VIP 50                              | 07  | FA235  |         | TBA    |  |     | TBA   |         |     |  |
| Comfort 125                         | 07  | FA86   | FA86HH  |        |  | N/A | TBA   |         |     |  |
| Freeland 125/150                    |     | FA264  |         | MD923D |  |     | S624  |         |     |  |
| Joker 125/150                       | 02  | FA264  |         | N/A    |  |     | TBA   |         |     |  |
| Panther 125/150/250                 | 02  | FA257  |         | N/A    |  |     | TBA   |         |     |  |
| Skyнет 250/400                      | 02  | FA281  |         | N/A    |  |     | FA193 |         | N/A |  |
| Eureka, Gulp                        |     | 908    |         |        |  |     | 908   |         |     |  |
| 50 Ciclone/KL50 SV                  |     |        | 926G    |        |  |     |       | 926G    |     |  |
| 50 Vip/Noi/Basic spoke wheel        |     | 908    |         |        |  |     | 908   |         |     |  |
| 50 Vip/Noi/Basic Alu Wheel          |     | 931    |         |        |  |     | 931   |         |     |  |
| Junior Turismo                      |     | 909    |         |        |  |     | 909   |         |     |  |
| Gran Turismo                        |     |        | 926G    |        |  |     |       | 926G    |     |  |
| 50 Tiger XLE                        | 86- | FA256  |         | N/A    |  |     | FA99  |         | N/A |  |
| Formuno 50 till chassis no. 2701551 | 87- | N/A    |         |        |  |     | 931   |         |     |  |
| Formuno 50 from chassis no. 2701552 | 87- | N/A    |         |        |  |     | 931   |         |     |  |
| 50 Team Matic                       | 88- | 877    |         |        |  |     | 931   |         |     |  |
| Sahel 50                            | 91- | FA116  |         | N/A    |  |     | FA115 | FA115R  | N/A |  |
| Urka 50                             | 91- | FA47   | FA47R   | N/A    |  |     | N/A   |         |     |  |
| Sahel 80                            | 91- | FA116  |         |        |  |     | FA115 | FA115R  | N/A |  |
| RSX 125                             | 81- |        | 821WG   |        |  |     |       | 821WG   |     |  |
| Strada/Sport 125                    |     | FA98   |         | N/A    |  |     | 921   |         |     |  |
| TSR 125                             | -83 | FA76   |         | N/A    |  |     | 921   |         |     |  |
| TSR 125                             | 83- | FA98   |         | N/A    |  |     | 921   |         |     |  |
| 125 XR/XRD Tiger                    | 83- | FA47   | FA47R   | N/A    |  |     | 952   |         |     |  |
| 125 Tiger XLE                       | 86- | FA256  |         | N/A    |  |     | FA60  |         | N/A |  |
| Tiger 125                           | 07  | FA197  | FA197HH | N/A    |  |     | FA197 | FA197HH | N/A |  |
| GTA 125                             | 85  | FA60*  |         | N/A    |  |     | 983   |         |     |  |
| GTA 125                             | 86- | FA60*  |         | N/A    |  |     | FA60  |         | N/A |  |

\*-2 Sets Required. ■ - Also available in MX-S race compound, see page 8. ✖ - Oversize and Supermoto disc available - see page 301.

**SAFETY WARNING-** DO NOT USE HH PADS ON REAR UNLESS ALSO USED ON FRONT TO AVOID BRAKE IMBALANCE.



# Non-Japanese Built Motorcycles/Quads



## GARELLI contd.

|                                    |       | Front/Avant/Vorn |                                 |                   | Frente/Anteriore    |  | Rear/Arrière/Hinten |                                 |         | Posterior/Posteriore       |  |
|------------------------------------|-------|------------------|---------------------------------|-------------------|---------------------|--|---------------------|---------------------------------|---------|----------------------------|--|
|                                    |       | 1                | 2                               | 3                 | 4                   | 5  | 6                   | 7                               | 8       | 9                          |  |
|                                    |       |                  | Sintered/HH Pads/ Grooved shoes | Left/Gauche/Links | Right/Droite/Rechts | Contour Rotor Universal left and right fitment |                     | Sintered/HH Pads/ Grooved shoes |         | Contour Rotor Rear fitment |  |
| Fashion 150                        | 07    | FA54             | FA54HH                          |                   | N/A                 |  | TBA                 |                                 |         |                            |  |
| Mosquito 150                       | 07    | FA86             | FA86HH                          | N/A               |                     |  | TBA                 |                                 |         |                            |  |
| Trial 320                          | -85   |                  | 841WG                           |                   |                     |  |                     | 841WG                           |         |                            |  |
| Trial 323                          | 86-   | FA115            | FA115R                          | N/A               |                     |  |                     | 930WG                           |         |                            |  |
| <b>GAS-GAS</b>                     |       |                  |                                 |                   |                     |  |                     |                                 |         |                            |  |
| Cross MC 50                        | 06    | FA291            |                                 | N/A               |                     |  | FA351               |                                 | N/A     |                            |  |
| EC 50 (Boy)                        | 01-04 | FA291            |                                 | N/A               |                     |  | FA291               |                                 | N/A     |                            |  |
| EC 50 Boy (Air Cooled)             | 05    | FA115            | FA115HH                         | N/A               |                     |  | FA351               |                                 | N/A     |                            |  |
| EC 50 Boy (LC)                     | 05-07 | FA303            |                                 | N/A               |                     |  | FA351               |                                 | N/A     |                            |  |
| EC 50 (Rookie)                     | 01-04 | FA167            | FA167HH                         | N/A               |                     |  | FA291               |                                 | N/A     |                            |  |
| EC 50                              | 05    | FA194            | FA194HH                         | N/A               |                     |  | FA291               |                                 | N/A     |                            |  |
| EC 50                              | 06-07 | FA115TT          | FA115R                          | N/A               |                     |  | FA351               |                                 | N/A     |                            |  |
| K1 Quad                            | 06    | TBA*             |                                 |                   |                     |  | TBA                 |                                 |         |                            |  |
| J50 Quad                           | 06    | TBA*             |                                 |                   |                     |  | FA115TT             | FA115R                          | N/A     |                            |  |
| Quad Wild HP 50                    | 04-07 | FA181TT*         | FA181R                          | N/A               |                     |  | FA181TT             | FA181R                          | N/A     |                            |  |
| SM 50 (Rookie)                     | 01-04 | FA167            | FA167HH                         | N/A               |                     |  | FA291               |                                 | N/A     |                            |  |
| SM 50                              | 05    | FA194            | FA194HH                         | N/A               |                     |  | FA291               |                                 | N/A     |                            |  |
| TXT 50 (Boy)                       | 01    | FA291            |                                 | N/A               |                     |  | FA291               |                                 | N/A     |                            |  |
| TXT 50 (Boy)                       | 04-07 | FA115            | FA115R                          | N/A               |                     |  | FA115               | FA115R                          | N/A     |                            |  |
| TXT 50/80 (Rookie)                 | 02-03 | FA291            |                                 | N/A               |                     |  | FA291               |                                 | N/A     |                            |  |
| Cross MC 65                        | 06    | FA351            |                                 | N/A               |                     |  | FA351               |                                 | N/A     |                            |  |
| MC 65                              | 05    | FA351            |                                 | N/A               |                     |  | FA115               |                                 | N/A     |                            |  |
| TXT 80 Cadet                       | 06    | FA351            |                                 | N/A               |                     |  | FA351               |                                 | N/A     |                            |  |
| TXT 80 Rookie                      | 04-05 | FA303            |                                 | N/A               |                     |  | FA351               |                                 | N/A     |                            |  |
| TXT Rookie 50/80 Trail             | 06-07 | FA291            |                                 | N/A               |                     |  | FA351               |                                 | N/A     |                            |  |
| Enduro EC 125/200/250/300 (Brembo) | 97-99 | FA181TT          | FA181R                          | N/A               |                     |  | FA208TT             | FA208R                          | MD6253D |                            |  |
| EC 125/200/250/300 (Nissin)        | 00-07 | FA185TT          | FA185R                          | MD6289D           |                     |  | FA131TT             | FA131R                          | MD6253D |                            |  |
| JTX 125/200/270/320                | 95-98 | FA115            | FA115R                          | N/A               |                     |  | FA115               | FA115R                          | N/A     |                            |  |
| MC 125                             | 05    | FA185TT          | FA185R                          | MD6289D           |                     |  | FA131TT             | FA131R                          | MD6253D |                            |  |
| MX 125/250                         | 01-04 | FA185TT          | FA185R                          | MD6289D           |                     |  | FA131TT             | FA131R                          | MD6253D |                            |  |
| Pampera 125/250/370                | 96-97 | FA115            | FA115R                          | N/A               |                     |  | FA115               | FA115R                          | N/A     |                            |  |
| Pampera 125/250/280                | 04    | FA194            | FA194HH                         | N/A               |                     |  | FA291               |                                 | N/A     |                            |  |
| Pampera 125/450                    | 05-07 | FA194            | FA194HH                         | N/A               |                     |  | FA131TT             | FA131R                          | MD6253D |                            |  |
| SM 125/250 (2T)                    | 01-06 | FA95             | FA95HH                          | MD6209D           |                     |  | FA131TT             |                                 | MD6253D |                            |  |
| TXT 125/200/249/280/321            | 00-03 | FA291            |                                 | N/A               |                     |  | FA291               |                                 | N/A     |                            |  |
| TXT 125/200/250/280/300 (TXT Pro)  | 04-07 | FA303            |                                 | N/A               |                     |  | FA351               |                                 | N/A     |                            |  |
| MX 200/250/300                     | 99-00 | FA181TT          | FA181R                          | N/A               |                     |  | FA131TT             | FA131R                          | MD6253D |                            |  |
| TX 200/270/320                     | 98    | FA115            | FA115R                          | N/A               |                     |  | FA115               | FA115R                          | N/A     |                            |  |
| TXT 200/270/321                    | 99    | FA291            |                                 | N/A               |                     |  | FA291               |                                 | N/A     |                            |  |
| Contact JT25 (238cc)               | 93-94 | FA115            | FA115R                          | N/A               |                     |  | FA115               | FA115R                          | N/A     |                            |  |
| Quad HP 240                        | 04-06 | FA181TT*         | FA181R                          | N/A               |                     |  | FA181TT             | FA181R                          | N/A     |                            |  |
| KS 250 RV Quad                     | Left  | FA135TT          | FA135R                          | N/A               |                     |  | TBA                 |                                 |         |                            |  |
|                                    | Right | FA165TT          | FA165R                          |                   | N/A                 |  |                     |                                 |         |                            |  |
| Pampera 250/320                    | 98-99 | FA115            | FA115R                          | N/A               | N/A                 |  | FA115               | FA115R                          | N/A     |                            |  |
| Pampera 250                        | 02-03 | FA194            | FA194HH                         | N/A               |                     |  | FA291               |                                 | N/A     |                            |  |
| Quad HP 300 RV                     | 03-06 | FA181TT*         | FA181R                          | N/A               | N/A                 |  | FA181TT             | FA181R                          | N/A     |                            |  |
| Pampera 400                        | 06    | FA181TT          | FA181R                          | N/A               |                     |  | FA131TT             | FA131R                          | N/A     |                            |  |
| SM 400 FSE (2T)                    | 01-02 | FA95             | FA95HH                          | MD6209D           |                     |  | FA131TT             | FA131R                          | MD6253D |                            |  |
| FSE 450/500                        | 05-06 | FA185TT          | FA185R                          | MD6209D           |                     |  | FA131TT             | FA131R                          | N/A     |                            |  |
| FSR 450 (4T)                       | 07    | FA95             | FA95HH                          | TBA               |                     |  | FA131TT             | FA131R                          | TBA     |                            |  |
| SM 450                             | 03-06 | FA95             | FA95HH                          | MD6209D           |                     |  | FA131TT             | FA131R                          | MD6253D |                            |  |
| Wild HP 450 Quad                   | 04-07 | FA181TT*         | FA181R                          | TBA               | TBA                 |  | FA181TT             | FA181R                          | TBA     |                            |  |
| <b>GENERIC</b>                     |       |                  |                                 |                   |                     |  |                     |                                 |         |                            |  |
| Ideo 50                            | 05-07 | FA235            |                                 | MD923D            |                     |  | Y503                |                                 |         |                            |  |
| Toxic 50                           | 07    | FA194            | FA194HH                         | N/A               |                     |  | FA260               | FA260HH                         | N/A     |                            |  |
| Trigger SM50                       | 06-07 | FA194            | FA194HH                         | TBA               |                     |  | FA60                |                                 | TBA     |                            |  |
| Trigger X50                        | 06-07 | FA194            | FA194HH                         | TBA               |                     |  | FA60                |                                 | TBA     |                            |  |
| XOR 50                             | 05-07 | FA235            |                                 | MD923D            |                     |  | Y503                |                                 |         |                            |  |

\*-2 Sets Required. ■ - Also available in MX-S race compound, see page 8. ✖ - Oversize and Supermoto disc available - see page 301.

**SAFETY WARNING-** DO NOT USE HH PADS ON REAR UNLESS ALSO USED ON FRONT TO AVOID BRAKE IMBALANCE.

R Suffix = High Durability Sintered Pad. HH Suffix = High Performance Sintered Pad. G Suffix = Grooved Shoe.  
D Suffix = Drilled Disc. C Suffix = Contoured Disc. LS Suffix = Left/Steel Disc. RS = Right/Steel Disc.

BRAKE APPLICATIONS

# Non-Japanese Built Motorcycles/Quads



## GENERIC contd.

|                |       | 1     | 2 | 3      | 4   | 5 | 6    | 7 | 8   | 9 |
|----------------|-------|-------|---|--------|-----|---|------|---|-----|---|
| Soho 125       | 06-07 | FA235 |   | TBA    |     |   | Y527 |   |     |   |
| XOR 125        | 05-07 | FA235 |   | MD923D |     |   | Y527 |   |     |   |
| Urano 260 Quad | 06    | TBA*  |   | N/A    | N/A |   | TBA  |   | TBA |   |

## GILERA

|  |           |              |                |               |     |  |              |                |               |  |
|--|-----------|--------------|----------------|---------------|-----|--|--------------|----------------|---------------|--|
| Built 50   | 90-       | FA99         |                | N/A           |     |  | 883          |                |               |  |
| CBA 50   |           | 908          |                |               |     |  | 907          |                |               |  |
| ec1 50   |           | 908          |                |               |     |  | 907          |                |               |  |
| ECO 50   |           | 908          |                |               |     |  | 907          |                |               |  |
| 503 50cc   | 91-       | FA99         |                | N/A           |     |  | FA99         |                | N/A           |  |
| 50 CBA/ECO/EC 1                                  |           | 908          |                |               |     |  | 907          |                |               |  |
| 50 GR 2  |           | 922          |                |               |     |  | 923          |                |               |  |
| 50 GSA/Vale                                      |           | 909          |                |               |     |  | 924          |                |               |  |
| 50 Rally   | 87-       | FA47/2       |                | N/A           |     |  | 845          |                |               |  |
| R1/50  | 90-       | FA47/2       |                | N/A           |     |  | N/A          |                |               |  |
| 50 RC Top Rally                                  | 90-       | FA173        |                | N/A           |     |  | FA173        |                | N/A           |  |
| 50 Trend   | 89-       | 909          |                |               |     |  | 909          |                |               |  |
| 50 Trial/Enduro                                  |           | 909          |                |               |     |  | 909          |                |               |  |
| DNA 50 (Grimeca Caliper)                         | 01-06     | FA194        | FA194HH        | MD944D        |     |  | FA260        | FA260HH        | MD910D        |  |
| DNA 50 (Heng Tong Caliper)                       | 01-05     | FA353        |                | MD944D        |     |  | FA260        |                | MD910D        |  |
| Eaglet 50  | 96        | FA99         |                | N/A           |     |  | FA382        |                | N/A           |  |
| Easy Moving 50                                   | 95-96     | FA193        | FA193HH        | MD904D        |     |  | 806          |                |               |  |
| GSM 50   | 00-03     | FA115        | FA115HH        | N/A           |     |  | FA115        | FA115HH        | N/A           |  |
| H@K 50   | 00-02     | FA115        | FA115HH        | N/A           |     |  | FA115        | FA115HH        | N/A           |  |
| Zulu 50  | 01-02     | FA115        | FA115HH        | N/A           |     |  | FA115        | FA115HH        | N/A           |  |
| Ice 50cc   | 01-02     | FA193        | FA193HH        | MD910D        |     |  | 899          |                |               |  |
| Runner 50 P.J/SP                                 | 06-07     | FA353        |                | MD956D        |     |  | FA260        | FA260HH        | MD932D        |  |
| Stalker 50 (Rear disc models) (Grimeca calipers) | 97-06     | FA193        | FA193HH        | MD943D        |     |  | FA260        | FA260HH        | MD932D        |  |
| Stalker 50 (Rear Drum Model) (Grimeca calipers)  | 97-06     | FA193        | FA193HH        | MD943D        |     |  | 899          |                |               |  |
| Stalker 50 (Rear disc model) (Heng Tong caliper) | 03-06     | FA83TT       | FA83HH         | MD943D        |     |  | FA260        | FA260HH        | MD932D        |  |
| Stalker 50 (Rear drum model) (Heng Tong caliper) | 03-07     | FA83TT       | FA83HH         | MD943D        |     |  | 899          |                |               |  |
| Runner 50  | 98        | FA193        | FA193HH        | MD924D        |     |  | 899          |                |               |  |
| 50 DD/SP Runner/Purejet                          | 99-05     | FA193        | FA193HH        | MD924D        |     |  | FA260        | FA260HH        | MD932D        |  |
| RCR 50 Enduro                                    | 03-06     | FA115        | FA115HH        | N/A           |     |  | FA115        | FA115HH        | N/A           |  |
| RK 50 Cannibal                                   | 96-98     | FA115        | FA115HH        | N/A           |     |  | FA115        | FA115HH        | N/A           |  |
| RV 50 NGR  | 88        | FA60*        |                | N/A           | N/A |  | FA47         |                | N/A           |  |
| SKP 50   | 98        | FA193        | FA193HH        | MD943D        |     |  | 899          |                |               |  |
| SKP 50   | 99-01     | FA193        | FA193HH        | MD943D        |     |  | FA260        | FA260HH        | MD932D        |  |
| SMT 50 Supermotard                               | 03-06     | FA115        | FA115HH        | N/A           |     |  | FA115        | FA115HH        | N/A           |  |
| <b>SMT 50</b>                                    | <b>07</b> | <b>FA115</b> | <b>FA115HH</b> | <b>N/A</b>    |     |  | <b>FA115</b> | <b>FA115HH</b> | <b>N/A</b>    |  |
| Storm 50   | 94-95     | FA193        | FA193HH        | MD943D        |     |  | 806          |                |               |  |
| Typhoon 50, All models                           | 93-95     | FA193        | FA193HH        | MD901D        |     |  | 886          |                |               |  |
| Typhoon 50                                       | 96-       | FA193        | FA193HH        | MD901D        |     |  | 806          |                |               |  |
| 80 TG 1/2/3                                      |           | FA76         |                |               |     |  | 843          |                |               |  |
| 98 Giubileo                                      |           |              | 821WG          |               |     |  | 922          |                |               |  |
| 124 Giubileo                                     |           |              | 821WG          |               |     |  | 922          |                |               |  |
| 125 Apache                                       | 91-       | FA134        | FA134R         | N/A           |     |  | FA101TT      | FA101R         | N/A           |  |
| 125 Arcore                                       |           |              | 843WG          |               |     |  | 922          |                |               |  |
| 125 CX   | 91-       | FA126        | FA126R         | N/A           |     |  | FA47         | FA47R          | N/A           |  |
| 125 GR 1   |           | FA76         |                | N/A           |     |  | 843          |                |               |  |
| 125 E 1/E 1 Competition                          |           |              | 841WG          |               |     |  |              | 843WG          |               |  |
| 125 TG 1/2/3                                     |           | FA76         |                |               |     |  | 921          |                |               |  |
| 125 HX LC  | 83-       | FA47         | FA47R          | N/A           |     |  | 952          |                |               |  |
| 125 RX   | 84-       | FA47         | FA47R          | N/A           |     |  |              | 954WG          |               |  |
| 125 MX1/MXR                                      | 89-       | FA126        | FA126R         | N/A           |     |  | FA47         | FA47R          | N/A           |  |
| 125 SP 01/SP 02                                  | 89-       | FA126        | FA126R         | N/A           |     |  | FA47         | FA47R          | N/A           |  |
| 125 XR1/XR2                                      | 89-       | FA256        | FA256HH        | N/A           |     |  | FA47         |                | N/A           |  |
| DNA 125/180                                      | 01-03     | FA194        | FA194HH        | MD944D        |     |  | FA321        |                | MD944D        |  |
| GFR 125  | 94        | FA126        | FA126HH        | N/A           |     |  | FA47         | FA47HH         | N/A           |  |
| <b>Nexus 125</b>                                 | <b>07</b> | <b>FA353</b> |                | <b>MD961D</b> |     |  | <b>FA353</b> |                | <b>MD960D</b> |  |

\*-2 Sets Required. ■ - Also available in MX-S race compound, see page 8. ✖ - Oversize and Supermoto disc available - see page 301.

**SAFETY WARNING- DO NOT USE HH PADS ON REAR UNLESS ALSO USED ON FRONT TO AVOID BRAKE IMBALANCE.**

# Non-Japanese Built Motorcycles/Quads



## GILERA contd.

|  |       | Front/Avant/Vorn                   |                                    |                   | Frente/Anteriore    |  | Rear/Arrière/Hinten                |                                    |                                    | Posterior/Posteriore          |  |
|--|-------|------------------------------------|------------------------------------|-------------------|---------------------|--|------------------------------------|------------------------------------|------------------------------------|-------------------------------|--|
|  |       | 1                                  | 2                                  | 3                 | 4                   | 5  | 6                                  | 7                                  | 8                                  | 9                             |  |
|  |       |                                    |                                    |                   |                     |  |                                    |                                    |                                    |                               |  |
|  |       | Sintered/HH Pads/<br>Grooved shoes | Sintered/HH Pads/<br>Grooved shoes | Left/Gauche/Links | Right/Droite/Rechts | Contour Rotor<br>Universal left and<br>right fitment | Sintered/HH Pads/<br>Grooved shoes | Sintered/HH Pads/<br>Grooved shoes | Sintered/HH Pads/<br>Grooved shoes | Contour Rotor<br>Rear fitment |  |
| RV 125   | 88    | FA98                               |                                    | N/A               |                     |  | 921                                |                                    |                                    |                               |  |
| RX 125 Arizona   | 88    | FA47                               | FA47R                              | N/A               |                     |  | 954                                |                                    |                                    |                               |  |
| Coguar 125   | 99-02 | FA256                              | FA256HH                            | N/A               |                     |  | 921                                |                                    |                                    |                               |  |
| Runner 125/180   | 98    | FA194                              | FA194HH                            | MD924D            |                     |  | 816                                |                                    |                                    |                               |  |
| Runner 125/180 FX/FXR/SP 2 stroke (Grimeca caliper)      | 99-02 | FA194                              | FA194HH                            | MD924D            |                     |  | FA260                              | FA260HH                            | MD944D                             |                               |  |
| Runner 125/180 FX/FXR/SP 2 stroke (Heng Tong caliper)    | 99-02 | FA353                              |                                    | MD924D            |                     |  | FA260                              |                                    | MD944D                             |                               |  |
| SC 125   | 06-07 | FA399                              |                                    | MD685LS           |                     |  | FA115                              |                                    | MD686                              |                               |  |
| 125 VX4T/180 VXR4T 'Runner'                              |       |                                    |                                    |                   |                     |  |                                    |                                    |                                    |                               |  |
| 4 stroke (Grimeca Caliper)                               | 01-04 | FA194                              | FA194HH                            | MD924D            |                     |  | FA321                              |                                    | MD910D                             |                               |  |
| 125 VX4T/180 VXR4T 'Runner'                              |       |                                    |                                    |                   |                     |  |                                    |                                    |                                    |                               |  |
| 4 stroke (Heng Tong Caliper)                             | 01-04 | FA353                              |                                    | MD924D            |                     |  | FA321                              |                                    | MD910D                             |                               |  |
| VX 125 Runner (4T)                                       | 05-07 | FA353                              |                                    | MD9112D           |                     |  | FA321                              |                                    | MD956D                             |                               |  |
| 150 Arcore   |       | 925                                |                                    |                   |                     |  |                                    | 843WG                              |                                    |                               |  |
| RX 200/Arizona/Enduro                                    | 85-   | FA47                               | FA47R                              | N/A               |                     |  |                                    | 954WG                              |                                    |                               |  |
| 200 Arizona Hawk   | 85-   | FA256                              | FA256HH                            | N/A               |                     |  |                                    | 954WG                              |                                    |                               |  |
| 200 RTX  | 85-   | FA256                              | FA256HH                            | N/A               |                     |  |                                    | 954WG                              |                                    |                               |  |
| 200 T4/T4 C/T4 S   |       | FA76                               |                                    | N/A               |                     |  | 921                                |                                    |                                    |                               |  |
| 200 ER   | 87-   | FA256                              | FA256HH                            | N/A               |                     |  |                                    | 954WG                              |                                    |                               |  |
| 200 Fast Bike  | 87-   | FA256                              | FA256HH                            | N/A               |                     |  | FA47                               |                                    | N/A                                |                               |  |
| RV 200   | 85-86 | FA98                               |                                    | N/A               |                     |  | FA47                               |                                    | N/A                                |                               |  |
| RV 200 ES  | 87-   | FA256                              | FA256HH                            | N/A               |                     |  | FA47                               |                                    | N/A                                |                               |  |
| VXR 200 Runner (4T) (6 bolt rear disc) Heng Tong caliper | 02-04 | FA353                              |                                    | MD924D            |                     |  | FA321                              |                                    | MD956D                             |                               |  |
| VXR 200 Runner (4T) (6 bolt rear disc) Grimeca caliper   | 02-04 | FA194                              | FA194HH                            | MD924D            |                     |  | FA321                              |                                    | MD956D                             |                               |  |
| VXR 200 Runner (4T) (6 bolt rear disc) Heng Tong caliper | 05-07 | FA353                              |                                    | MD9112D           |                     |  | FA321                              |                                    | MD956D                             |                               |  |
| HX 250 LC  | 83-   | FA47                               | FA47R                              | N/A               |                     |  | N/A                                |                                    |                                    |                               |  |
| Nexus 250 ie   | 07    | FA353                              |                                    | MD961D            |                     |  | FA353                              |                                    | MD960D                             |                               |  |
| NGR 250  | 85-   | FA60*                              |                                    | N/A               | N/A                 |  | FA47                               |                                    | N/A                                |                               |  |
| 250 RX Arizona Rally                                     | 86-   | FA47                               | FA47R                              | N/A               |                     |  |                                    | N/A                                |                                    |                               |  |
| Oregon 250 Quad  | 07    | FA101TT*                           | FA101R*                            | TBA               | TBA                 |  | FA355*                             | FA355R*                            | TBA                                |                               |  |
| RC 250 Rally   | 87-   | FA256                              | FA256HH                            | N/A               |                     |  | FA47                               |                                    | N/A                                |                               |  |
| 350 Dakota   | 85-   | FA256                              | FA256HH                            | N/A               |                     |  | 987                                |                                    |                                    |                               |  |
| ER 350   | 87-   | FA256                              | FA256HH                            | N/A               |                     |  | 987                                |                                    |                                    |                               |  |
| Saturno 350 Bialbero                                     | 90-   | FA95                               | FA95HH                             | N/A               |                     |  | FA47                               | FA47HH                             | N/A                                |                               |  |
| XRT 350  | 90-   | FA256                              | FA256HH                            | N/A               |                     |  | FA47                               | FA47HH                             | N/A                                |                               |  |
| Nord-West 350  | 94-   | FA163                              |                                    | N/A               |                     |  | FA47                               |                                    | N/A                                |                               |  |
| or   |       | FA126*                             | FA126R*                            | N/A               | N/A                 |  |                                    |                                    |                                    |                               |  |
| 500 Dakota   | 87-   | FA256                              | FA256HH                            | N/A               |                     |  | 987                                |                                    |                                    |                               |  |
| ER 500   | 87-   | FA256                              | FA256HH                            | N/A               |                     |  | 987                                |                                    |                                    |                               |  |
| Fuoco 500 ie   | 07    | FA260*                             | FA260HH*                           | MD9112D           | MD9112D             |  | FA425                              |                                    | MD960D                             |                               |  |
| Parking brake  |       | FA257/2                            |                                    |                   |                     |  |                                    |                                    |                                    |                               |  |
| Saturno 500 S/Bialbero/Piuma                             | 90-   | FA95                               | FA95HH                             | N/A               |                     |  | FA47                               | FA47R                              | N/A                                |                               |  |
| Nordwest   | 94-96 | FA126                              | FA126HH                            | N/A               |                     |  | FA47                               | FA47HH                             | N/A                                |                               |  |
| Nexus 500  | 03-07 | FA181TT*                           | FA181HH*                           | MD983D            | MD983D              |  | FA266                              | FA266HH                            | MD960D                             |                               |  |
| 600 Supersport   | 02    |                                    | FA322/4HH*                         | MD636LS           | MD636RS             |  | FA266                              | FA266HH                            | TBA                                |                               |  |
| RC 600   | 89-90 | FA134                              |                                    | N/A               |                     |  | FA101TT                            |                                    | N/A                                |                               |  |
| R 600  | 91-92 | FA134                              |                                    | N/A               |                     |  | FA101TT                            |                                    | N/A                                |                               |  |
| RC 600 Cobra   | 91-93 | FA134                              |                                    | N/A               |                     |  | FA101TT                            |                                    | N/A                                |                               |  |
| XRT 600  | 88-   | FA256                              | FA256HH                            | N/A               |                     |  | FA47                               | FA47HH                             |                                    |                               |  |
| GP 800   | 07    | FA181TT*                           | FA181HH*                           | TBA               | TBA                 |  | TBA                                |                                    | TBA                                |                               |  |
| <b>GOES</b>  |       |                                    |                                    |                   |                     |  |                                    |                                    |                                    |                               |  |
| 50 XS  | 05-07 | TBA*                               |                                    |                   |                     |  | TBA                                |                                    |                                    |                               |  |
| Goes 20  | 05-06 | TBA                                |                                    | N/A               |                     |  | FA67TT                             | FA67R                              | N/A                                |                               |  |
| 220  | 06-07 | FA83TT*                            | FA83R*                             | TBA               | TBA                 |  | FA83TT                             | FA83R                              | TBA                                |                               |  |
| 320 Max  | 07    | FA83TT*                            | FA83R*                             | TBA               | TBA                 |  | FA83TT                             | FA83R                              | TBA                                |                               |  |
| 450 X  | 07    | TBA*                               |                                    | TBA               | TBA                 |  | TBA                                |                                    | TBA                                |                               |  |
| 520/520 Max  | 07    | TBA*                               |                                    | TBA               | TBA                 |  | TBA                                |                                    | TBA                                |                               |  |

\*-2 Sets Required. ■ - Also available in MX-S race compound, see page 8. ✖ - Oversize and Supermoto disc available - see page 301.

**SAFETY WARNING-** DO NOT USE HH PADS ON REAR UNLESS ALSO USED ON FRONT TO AVOID BRAKE IMBALANCE.

**R** Suffix = High Durability Sintered Pad. **HH** Suffix = High Performance Sintered Pad. **G** Suffix = Grooved Shoe.  
**D** Suffix = Drilled Disc. **C** Suffix = Contoured Disc. **LS** Suffix = Left/Steel Disc. **RS** = Right/Steel Disc.

**BRAKE APPLICATIONS**

# Non-Japanese Built Motorcycles/Quads

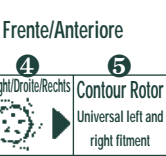

## HARTFORD/HRD

|                       |       | 1     | 2       | 3   | 4 | 5 | 6     | 7 | 8   | 9 |
|-----------------------|-------|-------|---------|-----|---|---|-------|---|-----|---|
| VR-125 Z Velo Sport   | 00-03 | FA228 | FA228HH | N/A |   |   | H304  |   |     |   |
| VR-125 X/H Velo-Cross | 00-03 | FA228 | FA228HH | N/A |   |   | H304  |   |     |   |
| VR 125/150 H/X/Z      | 04    | FA228 | FA228HH | N/A |   |   | FA197 |   | N/A |   |
| HD 125 L/150 L        | 00-04 | FA93  |         | N/A |   |   | S602  |   |     |   |
| Cabriolet 125         | 01    | FA167 | FA167HH | N/A |   |   | FA115 |   | N/A |   |

## HERO

|               |    |       |         |     |     |  |     |  |  |  |
|---------------|----|-------|---------|-----|-----|--|-----|--|--|--|
| Nipster 50    | 06 | FA169 |         | TBA |     |  | TBA |  |  |  |
| Magellan 125  | 06 | FA197 | FA197HH |     | N/A |  | TBA |  |  |  |
| Punto 125     | 06 | FA197 | FA197HH |     | N/A |  | TBA |  |  |  |
| Quickster 125 | 06 | FA101 |         |     | TBA |  | TBA |  |  |  |
| Slickster 125 | 06 | FA86  | FA86HH  |     | N/A |  | TBA |  |  |  |

## HIGHLAND

|                |       |         |        |     |  |  |         |        |     |  |
|----------------|-------|---------|--------|-----|--|--|---------|--------|-----|--|
| 950 V2 Outback | 00-04 | FA181TT | FA181R | N/A |  |  | FA208TT | FA208R | N/A |  |
| 950 V2 Motard  | 00-04 | FA181TT | FA181R | N/A |  |  | FA208TT | FA208R | N/A |  |

## HONDA DALL-ARA

|               |    |         |        |          |  |         |         |        |         |         |
|---------------|----|---------|--------|----------|--|---------|---------|--------|---------|---------|
| XR 125 SM     | 04 | FA185TT | FA185R | TBA      |  |         | FA115   | FA115R | TBA     |         |
| XR 250 R      | 04 | FA185TT | FA185R | MD6001DX |  | MD6001C | FA131TT | FA131R | MD6013D | MD6013C |
| XR 250 SM     | 04 | FA185TT | FA185R | TBA      |  |         | FA346TT | FA346R | MD6013D | MD6013C |
| XR 400/440 R  | 04 | FA185TT | FA185R | MD6037DX |  | MD6037C | FA346TT | FA346R | MD6013D | MD6013C |
| XR 400/440 SM | 04 | FA185TT | FA185R | TBA      |  |         | FA346TT | FA346R | MD6013D | MD6013C |
| XR 650 R      | 04 | FA185TT | FA185R | MD6001DX |  | MD6001C | FA131TT | FA131R | MD6181D |         |
| XR 650 R      | 04 | FA185TT | FA185R | TBA      |  |         | FA131TT | FA131R | MD6181D |         |

## HONDA-HM (ITALY)

|  |       |         |           |          |  |         |              |        |         |         |
|--|-------|---------|-----------|----------|--|---------|--------------|--------|---------|---------|
| Baja 10/10 JR & SR   | 99-07 | FA351   |           | N/A      |  |         | FA351        |        | N/A     |         |
| Baja 12/14 MX  | 99-07 | FA351   |           | N/A      |  |         | FA351        |        | N/A     |         |
| CRE 50 Six/Baja/Derapage Brembo caliper twin pin<br>/41mm paioli forks                         | 95-02 | FA194   | FA194HH   | N/A      |  |         | FA101/47/382 | N/A    |         |         |
| ⚠Note choice of 3 different pads on rear caliper - check shape in buyers guide - FA47/101/382. |       |         |           |          |  |         |              |        |         |         |
| CRE 50 Six/Baja/Derapage Brembo caliper single pin<br>/Kayaba forks                            | 95-02 | FA134   | FA134R    | N/A      |  |         | FA101/47/382 | N/A    |         |         |
| ⚠Note choice of 3 different pads on rear caliper - check shape in buyers guide - FA47/101/382. |       |         |           |          |  |         |              |        |         |         |
| CRE 50 Six/Baja/Derapage Grimeca caliper twin pin<br>/Kayaba forks                             | 95-02 | FA166   |           | N/A      |  |         | FA101/47/382 | N/A    |         |         |
| ⚠Note choice of 3 different pads on rear caliper - check shape in buyers guide - FA47/101/382. |       |         |           |          |  |         |              |        |         |         |
| CRE 50 Six/Baja/Derapage Grimeca   | 95-02 | FA382   |           | N/A      |  |         | FA101/47/382 | N/A    |         |         |
| ⚠Note choice of 3 different pads on rear caliper - check shape in buyers guide - FA47/101/382. |       |         |           |          |  |         |              |        |         |         |
| CRE 50 Six   | 01-02 | FA181TT | FA181R    | N/A      |  |         | FA382        |        | N/A     |         |
| CRE 50 Baja/Derapage   | 01-02 | FA181TT | FA181R    | N/A      |  |         | FA115TT      | FA115R | N/A     |         |
| CRE 50 Baja/Six/Derapage   | 03-06 | FA194   | FA194HH   | N/A      |  |         | FA350        |        | N/A     |         |
| CRE 80   | 98-02 | FA84TT  | FA84R     | MD6058DX |  | MD6058C | FA131TT      | FA131R | MD6005D | MD6005C |
| CR 85 R/R2   | 03-07 | FA84TT  | FA84R     | MD6058DX |  | MD6058C | FA131TT      | FA131R | MD6005D | MD6005C |
| CRE 125  | 95-97 | FA185TT | FA185R    | MD6037DX |  | MD6037C | FA131TT      | FA131R | MD6002D |         |
| CRE 125  | 98-01 | FA185TT | FA185R    | MD6037DX |  | MD6037C | FA131TT      | FA131R | MD6124D | MD6124C |
| CRE 125 R Supermotard  | 02-06 | FA185TT | FA185R    | N/A      |  | MD6037C | FA346TT      | FA346R | MD6191D | MD6191C |
| CRE 125 R Enduro   | 02-03 | FA185TT | FA185R    | MD6037D  |  | MD6037C | FA346TT      | FA346R | MD6191D | MD6191C |
| CRE 125 R Enduro   | 04-07 | FA185TT | FA185R    | MD6037DX |  | MD6037C | FA346TT      | FA346R | MD6191D | MD6191C |
| CR 125 Motard  | 04-06 | FA185TT | FA185R    | SM6437   |  | MD6037C | FA346TT      | FA346R | MD6191D | MD6191C |
| CRM 125 R Supermoto  | 07    | FA433/4 | FA433/4HH | N/A      |  |         | FA346TT      | FA346R | MD6191D | MD6191C |
| CR 150 R/R2  | 07    | FA84TT  | FA84/3R   | MD6058DX |  | MD6058C | FA346TT      | FA346R | MD6005D | MD6005C |
| CRF 230 Easy Trail   | 04-07 | FA185TT | FA185R    | MD6001DX |  | MD6001C | FA346TT      | FA346R | MD6191D | MD6191C |
| CRF 230 Easy Enduro  | 04-07 | FA185TT | FA185R    | MD6001DX |  | MD6001C | FA346TT      | FA346R | MD6191D | MD6191C |
| CRF 230 Easy Motard  | 04-07 | FA185TT | FA185R    | N/A      |  | MD6037C | FA346TT      | FA346R | MD6191D | MD6191C |

\*-2 Sets Required. ■ - Also available in MX-S race compound, see page 8. ✖ - Oversize and Supermoto disc available - see page 301.

**SAFETY WARNING-** DO NOT USE HH PADS ON REAR UNLESS ALSO USED ON FRONT TO AVOID BRAKE IMBALANCE.

APPLICATIONS

BRAKE

G Suffix = Grooved Shoe.

HH Suffix = High Performance Sintered Pad.

R Suffix = High Durability Sintered Pad.

LS Suffix = Left/Steel Disc. RS = Right/Steel Disc. C Suffix = Contoured Disc. D Suffix = Drilled Disc.

# Non-Japanese Built Motorcycles/Quads



## HONDA-HM (ITALY) contd.

|                                   |       | Front/Avant/Vorn |                                    |                       | Frente/Anteriore        |  | Rear/Arrière/Hinten |                                    |         | Posterior/Posteriore          |  |
|-----------------------------------|-------|------------------|------------------------------------|-----------------------|-------------------------|--|---------------------|------------------------------------|---------|-------------------------------|--|
|                                   |       | 1                | 2                                  | 3                     | 4                       | 5  | 6                   | 7                                  | 8       | 9                             |  |
|                                   |       |                  | Sintered/HH Pads/<br>Grooved shoes | Left/Gauche/Links<br> | Right/Droite/Rechts<br> | Contour Rotor<br>Universal left and<br>right fitment |                     | Sintered/HH Pads/<br>Grooved shoes |         | Contour Rotor<br>Rear fitment |  |
| CRF 230 F Easy Trial (All models) | 04-07 | FA185TT          | FA185R■                            | MD6001D✗              |                         | MD6001C  | H304                |                                    |         |                               |  |
| CRE 250                           | 97-01 | FA185TT          | FA185R■                            | MD6037D✗              |                         | MD6037C  | FA131TT             | FA131R■                            | MD6124D | MD6124C                       |  |
| CRE 250                           | 02    | FA185TT          | FA185R■                            | MD6037D✗              |                         | MD6037C  | FA346TT             | FA346R■                            | MD6191D | MD6191C                       |  |
| CRE 250 R Supermotard             | 02-03 | FA185TT          | FA185R■                            | N/A                   |                         | MD6037C  | FA346TT             | FA346R■                            | MD6191D | MD6191C                       |  |
| CRE 250 R Enduro                  | 02-07 | FA185TT          | FA185R■                            | MD6037D✗              |                         | MD6037C  | FA346TT             | FA346R■                            | MD6191D | MD6191C                       |  |
| CR 250 R Moto                     | 04    | FA185TT          | FA185R■                            | MD6037D✗              |                         | MD6037C  | FA346TT             | FA346R■                            | MD6191D | MD6191C                       |  |
| CRE Enduro F 250 R                | 04-06 | FA185TT          | FA185R■                            | MD6037D✗              |                         | MD6037C  | FA346TT             | FA346R■                            | MD6191D | MD6191C                       |  |
| CRE 250 R Enduro                  | 04-07 | FA185TT          | FA185R■                            | MD6037D✗              |                         | MD6037C  | FA346TT             | FA346R■                            | MD6191D | MD6191C                       |  |
| CRF 250 Motard                    | 04-06 | FA185TT          | FA185R■                            | MD6037D✗              |                         | MD6037C  | FA346TT             | FA346R■                            | MD6191D | MD6191C                       |  |
| CRM 250 X Supermoto               | 07    | FA433/4          | FA433/4HH                          | N/A                   |                         |  | FA346TT             | FA346R■                            | MD6191D | MD6191C                       |  |
| CRE 260                           | 95-96 | FA185TT          | FA185R■                            | MD6001D✗              |                         | MD6001C  | FA131TT             | FA131R■                            | MD6002D |                               |  |
| CRE 260                           | 97-98 | FA185TT          | FA185R■                            | MD6001D✗              |                         | MD6001C  | FA131TT             | FA131R■                            | MD6124D | MD6123C                       |  |
| CRE F 290 C                       | 07    | FA185TT          | FA185R■                            | MD6037D✗              |                         | MD6037C  | FA346TT             | FA346R■                            | MD6191D | MD6191C                       |  |
| CRE 450 F                         | 02    | FA185TT          | FA185R■                            | MD6037D✗              |                         | MD6037C  | FA346TT             | FA346R■                            | MD6191D | MD6191C                       |  |
| CRE 450 R Enduro                  | 02-07 | FA185TT          | FA185R■                            | MD6037D✗              |                         | MD6037C  | FA346TT             | FA346R■                            | MD6191D | MD6191C                       |  |
| CRE F 450 R Enduro                | 04-07 | FA185TT          | FA185R■                            | MD6037D✗              |                         | MD6037C  | FA346TT             | FA346R■                            | MD6191D | MD6191C                       |  |
| CRE 450 F Supermoto               | 02-03 | FA185TT          | FA185R■                            | N/A                   |                         | MD6037C  | FA346TT             | FA346R■                            | MD6191D | MD6191C                       |  |
| CRE Enduro F 450 X                | 04-07 | FA185TT          | FA185R■                            | MD6037D✗              |                         | MD6037C  | FA346TT             | FA346R■                            | MD6191D | MD6191C                       |  |
| CRF 450 Motard                    | 04-06 | FA185TT          | FA185R■                            | N/A                   |                         | MD6037C  | FA346TT             | FA346R■                            | MD6191D | MD6191C                       |  |
| CRM F 450 R Supermoto             | 07    | FA433/4          | FA433/4HH                          | N/A                   |                         |  | FA346TT             | FA346R■                            | MD6191D | MD6191C                       |  |
| CRM F 450 X Supermoto             | 07    | FA433/4          | FA433/4HH                          | N/A                   |                         |  | FA346TT             | FA346R■                            | MD6191D | MD6191C                       |  |
| CRE F 490 X                       | 07    | FA185TT          | FA185R■                            | MD6037D✗              |                         | MD6037C  | FA346TT             | FA346R■                            | MD6191D | MD6191C                       |  |
| CRM F 490 X Supermoto             | 07    | FA433/4          | FA433/4HH                          | N/A                   |                         |  | FA346TT             | FA346R■                            | MD6191D | MD6191C                       |  |

Note:- When using SM & OS discs on 04 models order OS or SM6437 version.

## HONGDOU

|                 |       |      |        |     |     |  |      |  |  |  |
|-----------------|-------|------|--------|-----|-----|--|------|--|--|--|
| CTM 125 Chituma | 04    | FA86 | FA86HH |     | N/A |  | Y516 |  |  |  |
| HD 125-7        | 05-07 | TBA  |        | TBA |     |  | TBA  |  |  |  |

## HOREX

|                  |     |       |         |     |     |  |      |        |     |  |
|------------------|-----|-------|---------|-----|-----|--|------|--------|-----|--|
| Rebell 80 N      |     | FA50  |         | N/A |     |  | N/A  |        |     |  |
| Rebell 80 T      |     | FA50* |         | N/A | N/A |  | N/A  |        |     |  |
| Sport 80 L       |     | FA50* |         | N/A | N/A |  | N/A  |        |     |  |
| HRD 600          | 85  | FA18* | FA18HH* | N/A | N/A |  | FA18 | FA18HH | N/A |  |
| 500/600 Columbus | 88- | FA18* | FA18HH* | N/A | N/A |  | FA18 | FA18HH | N/A |  |
| 644 Ossa         | 92- |       |         |     |     |  |      |        |     |  |

## HRD

|                            |     |       |         |     |  |  |         |        |     |  |
|----------------------------|-----|-------|---------|-----|--|--|---------|--------|-----|--|
| GS 50                      |     | FA194 |         | N/A |  |  | FA208TT | FA208R | N/A |  |
| RP 50 Cross                |     |       | 944WG   |     |  |  |         | 944WG  |     |  |
| Sonic 2 Trail 50           |     | FA167 | FA167HH | N/A |  |  | FA115   | FA115R | N/A |  |
| Sonic 2 Supermotard 50     |     | FA167 | FA167HH | N/A |  |  | FA115   | FA115R | N/A |  |
| SX 50 Mini Cross           |     | FA293 |         | N/A |  |  | FA293   |        | N/A |  |
| RP 80 Cross                | 83- |       | 944WG   |     |  |  |         | 944WG  |     |  |
| Cabriollet Trail 125       |     | FA167 | FA167HH | N/A |  |  | FA115   | FA115R | N/A |  |
| Cabriollet Supermotard 125 |     | FA167 | FA167HH | N/A |  |  | FA115   | FA115R | N/A |  |
| WH 125 Road/Red Horse      | 85- | FA47  | FA47R   | N/A |  |  |         |        |     |  |

## HUSABERG

|   |       |          |          |          |     |         |         |         |         |         |
|---|-------|----------|----------|----------|-----|---------|---------|---------|---------|---------|
| Enforcer Four   | 00-03 | FA181TT* | FA181R*■ | N/A      | N/A |         | FA181TT | FA181R■ | N/A     |         |
| All models (central fixing pin in pad)  | 89-92 | FA134    | FA134R   | N/A      |     |         | FA67TT  | FA67R   | N/A     |         |
| All models (fixing pin at end of brake pad)   | 93-94 | FA181TT  | FA181R■  | MD6125D✗ |     |         | FA67TT  | FA67R   | MD6126D |         |
| All models (fixing pin at end of brake pad)   | 95-99 | FA181TT  | FA181R■  | MD6125D✗ |     |         | FA208TT | FA208R■ | MD6126D |         |
| All MX/Enduro models  |       |          |          |          |     |         |         |         |         |         |
| (Brembo 2 piston caliper 260mmØ front disc)   | 00-05 | FA181TT  | FA181R■  | MD6032D✗ |     | MD6032C | FA208TT | FA208R■ | MD6035D | MD6035C |
| All supermotard models (Beringer 4 piston caliper central pin fixing 310mmØ front disc) | 00-03 | FA158    | FA158HH  | N/A      |     |         | FA208TT | FA208R■ | MD6035D |         |
| FE 450 E  | 06-07 | FA181TT  | FA181R■  | MD6032D✗ |     | MD6032C | FA208TT | FA208R■ | MD6035D | MD6035C |
| FS 450 C  | 06    |          | MXS405   | N/A      |     |         | FA208TT | FA208R■ | MD6035D | MD6035C |

\*-2 Sets Required. ■ - Also available in MX-S race compound, see page 8. ✗ - Oversize and Supermoto disc available - see page 301.

**SAFETY WARNING-** DO NOT USE HH PADS ON REAR UNLESS ALSO USED ON FRONT TO AVOID BRAKE IMBALANCE.

R Suffix = High Durability Sintered Pad. HH Suffix = High Performance Sintered Pad. G Suffix = Grooved Shoe.  
D Suffix = Drilled Disc. C Suffix = Contoured Disc. LS Suffix = Left/Steel Disc. RS = Right/Steel Disc.

BRAKE APPLICATIONS

# Non-Japanese Built Motorcycles/Quads



Front/Avant/Vorn



Frente/Anteriore

Rear/Arrière/Hinten



Posterior/Posteriore

1

2

3

4

5

6

7

8

9

## HUSABERG contd.

|  |       | 1                              | 2                              | 3                 | 4                   | 5  | 6                              | 7                              | 8                          | 9                          |
|--|-------|--------------------------------|--------------------------------|-------------------|---------------------|--|--------------------------------|--------------------------------|----------------------------|----------------------------|
|  |       | Sintered/HH Pads/Grooved shoes | Sintered/HH Pads/Grooved shoes | Left/Gauche/Links | Right/Droite/Rechts | Contour Rotor Universal left and right fitment | Sintered/HH Pads/Grooved shoes | Sintered/HH Pads/Grooved shoes | Contour Rotor Rear fitment | Contour Rotor Rear fitment |
| FS 450 E   | 06    |                                | MXS405                         | N/A               |                     |  | FA208TT                        | FA208R                         | MD6035D                    | MD6035C                    |
| FE 550 E   | 06-07 | FA181TT                        | FA181R                         | MD6032D*          |                     | MD6032C  | FA208TT                        | FA208R                         | MD6035D                    | MD6035C                    |
| FS 550 E Supermoto   | 05-07 |                                | MXS405                         | MD6270D           |                     | MD6270C  | FA208TT                        | FA208R                         | MD6035D                    | MD6035C                    |
| FE 650 E   | 06-07 | FA181TT                        | FA181R                         | MD6032D*          |                     | MD6032C  | FA208TT                        | FA208R                         | MD6035D                    | MD6035C                    |
| FS 650 C Supermoto   | 06-07 |                                | MXS405                         | MD6270D           |                     | MD6270C  | FA208TT                        | FA208R                         | MD6035D                    | MD6035C                    |
| FS 650 E Supermoto   | 05-07 |                                | MXS405                         | MD6270D           |                     | MD6270C  | FA208TT                        | FA208R                         | MD6035D                    | MD6035C                    |
| FS Supermotard Models (Beringer /FTE 6 piston caliper 310mmØ front disc) | 04    |                                | MXS406                         | MD6270D           |                     | MD6270C  | FA208TT                        | FA208R                         | MD6035D                    | MD6035C                    |
| FS Supermotard Models (FTE 4 piston radial caliper)                      | 05-07 |                                | MXS405                         | MD6270D           |                     | MD6270C  | FA208TT                        | FA208R                         | MD6035D                    | MD6035C                    |

## HUSQVARNA

|                             |       |         |         |         |  |  |         |         |         |  |
|-----------------------------|-------|---------|---------|---------|--|--|---------|---------|---------|--|
| Husky Boy                   | 98-99 |         | FA282R  | N/A     |  |  |         | FA282R  | N/A     |  |
| Husky Boy Racing S          | 00    | 984     |         |         |  |  | 984     |         |         |  |
| Husky Boy Drum front & rear | 00-02 | 984     |         |         |  |  | 984     |         |         |  |
| Husky Boy Racing J          | 00    | 984     |         |         |  |  | 984     |         |         |  |
| Husky Boy J                 | 01-02 | FA115T  | FA115R  | N/A     |  |  | 984     |         |         |  |
| Husky Boy R                 | 01    | FA115T  | FA115R  | N/A     |  |  | 984     |         |         |  |
| Husky Boy S                 | 01-02 | FA115T  | FA115R  | N/A     |  |  | 984     |         |         |  |
| CR 50 Junior                | 05    | FA351   |         | N/A     |  |  | TBA     |         |         |  |
| CR 50 Junior Basic          | 05    | TBA     |         |         |  |  | TBA     |         |         |  |
| CR 50 Senior Pro            | 05    | FA351   |         | N/A     |  |  | FA325TT |         | N/A     |  |
| SM 50                       | 02    | FA167   | FA167HH | TBA     |  |  | FA115   | FA115HH | TBA     |  |
| TE 50 Boy                   | 05    | TBA     |         |         |  |  | TBA     |         |         |  |
| WR 50                       | 02    | FA167   | FA167HH | N/A     |  |  | FA115   | FA115HH | N/A     |  |
| WRS 50 Scooter              | 98-00 | FA115   | FA115HH | MD964D  |  |  | S624    |         |         |  |
| TE 100                      | 05    | FA351   |         | N/A     |  |  | TBA     |         |         |  |
| CR 125                      | 73-77 | N/A     |         |         |  |  | N/A     |         |         |  |
| CR 125                      | 78    |         | 801G    |         |  |  | N/A     |         |         |  |
| CR 125                      | 79-81 |         | 801G    |         |  |  |         | 801G    |         |  |
| CR 125                      | 82-84 |         | 803G    |         |  |  |         | 801G    |         |  |
| CR 125                      | 85-86 | FA47TT  | FA47R   | N/A     |  |  |         | 802G    |         |  |
| CR 125                      | 91    | FA134   | FA134R  | N/A     |  |  | FA251   |         | MD6126D |  |
| CR 125                      | 92-94 | FA135TT | FA135R  | MD6125D |  |  | FA84TT  | FA84R   | MD6126D |  |
| CR 125                      | 95-99 | FA181TT | FA181R  | MD6125D |  |  | FA208TT | FA208R  | MD6126D |  |
| CR 125                      | 00-01 | FA181TT | FA181R  | MD6184D |  |  | FA208TT | FA208R  | MD6287D |  |
| CR 125                      | 02-04 | FA181TT | FA181R  | MD6184D |  |  | FA208TT | FA208R  | MD6295D |  |
| CR 125                      | 05    | FA181TT | FA181R  | MD6184D |  |  | FA368TT | FA368R  | MD6295D |  |
| CR 125                      | 06-07 | FA181TT | FA181R  | MD6184D |  |  | FA368TT | FA368R  | MD6288D |  |
| SC 125                      | 73-74 | N/A     |         |         |  |  | N/A     |         |         |  |
| SM 125                      | 98-99 | FA181TT | FA181R  | MD6125D |  |  | FA208TT | FA208R  | MD6126D |  |
| SM 125                      | 00    | FA181TT | FA181R  | MD6184D |  |  | FA208TT | FA208R  | MD6287D |  |
| SM 125 S                    | 02-07 | FA181TT | FA181R  | MD6184D |  |  | FA208TT | FA208R  | MD6287D |  |
| WR 125                      | 73-74 | N/A     |         |         |  |  | N/A     |         |         |  |
| WR 125                      | 79    |         | 801G    |         |  |  |         | 801G    |         |  |
| WR 125                      | 80-81 |         | 802G    |         |  |  |         | 802G    |         |  |
| WR 125                      | 82-84 |         | 803G    |         |  |  |         | 802G    |         |  |
| WR 125                      | 87-88 | FA134   | FA134R  | N/A     |  |  |         | 802G    |         |  |
| WR 125                      | 91    | FA134   | FA134R  | N/A     |  |  | FA251   |         | MD6126D |  |
| WR 125                      | 93-94 | FA135TT | FA135R  | MD6125D |  |  | FA84TT  | FA84R   | MD6126D |  |
| WR 125                      | 95-99 | FA181TT | FA181R  | MD6125D |  |  | FA208TT | FA208R  | MD6126D |  |
| WR 125                      | 00-01 | FA181TT | FA181R  | MD6184D |  |  | FA208TT | FA208R  | MD6287D |  |
| WR 125                      | 02-05 | FA181TT | FA181R  | MD6184D |  |  | FA208TT | FA208R  | MD6295D |  |
| WR 125                      | 06-07 | FA181TT | FA181R  | MD6184D |  |  | FA368TT | FA368R  | MD6288D |  |
| WRE 125                     | 93-99 | FA181TT | FA181R  | MD6125D |  |  | FA208TT | FA208R  | MD6126D |  |
| WRE 125                     | 00    | FA181TT | FA181R  | MD6184D |  |  | FA208TT | FA208R  | MD6287D |  |
| WRE 125                     | 02-07 | FA181TT | FA181R  | MD6184D |  |  | FA208TT | FA208R  | MD6287D |  |
| WXE 125                     | 07    | FA167   | FA167HH | MD6184D |  |  | FA131TT | FA131R  | TBA     |  |
| XC 125                      | 82-84 |         | 803G    |         |  |  |         | 802G    |         |  |
| XC 125                      | 85-86 | FA47TT  | FA47R   | N/A     |  |  |         | 801G    |         |  |

\*-2 Sets Required. ■ - Also available in MX-S race compound, see page 8. ✖ - Oversize and Supermoto disc available - see page 301.

**SAFETY WARNING- DO NOT USE HH PADS ON REAR UNLESS ALSO USED ON FRONT TO AVOID BRAKE IMBALANCE.**

# Non-Japanese Built Motorcycles/Quads



HUSQVARNA contd.

|                  |       | Front/Avant/Vorn |                                    |                       | Frente/Anteriore        |  | Rear/Arrière/Hinten |                                    |         | Posterior/Posteriore          |  |
|------------------|-------|------------------|------------------------------------|-----------------------|-------------------------|--|---------------------|------------------------------------|---------|-------------------------------|--|
|                  |       | 1                | 2                                  | 3                     | 4                       | 5  | 6                   | 7                                  | 8       | 9                             |  |
|                  |       |                  | Sintered/HH Pads/<br>Grooved shoes | Left/Gauche/Links<br> | Right/Droite/Rechts<br> | Contour Rotor<br>Universal left and<br>right fitment |                     | Sintered/HH Pads/<br>Grooved shoes |         | Contour Rotor<br>Rear fitment |  |
| CR 240           | 80-81 |                  | 802G                               |                       |                         |  |                     | 801G                               |         |                               |  |
| CR 240           | 82-84 |                  | 803G                               |                       |                         |  |                     | 801G                               |         |                               |  |
| CR 240           | 85-86 | FA47TT           | FA47R                              | N/A                   |                         |  |                     | 802G                               |         |                               |  |
| CR 240           | 87-88 | FA134            | FA134R                             | N/A                   |                         |  |                     | 802G                               |         |                               |  |
| WR 240           | 78    |                  | 801G                               |                       |                         |  |                     | 801G                               |         |                               |  |
| WR 240           | 80-81 |                  | 802G                               |                       |                         |  |                     | 802G                               |         |                               |  |
| WR 240           | 82-84 |                  | 803G                               |                       |                         |  |                     | 802G                               |         |                               |  |
| WR 240           | 87-88 | FA134            | FA134R                             | N/A                   |                         |  |                     | 802G                               |         |                               |  |
| WR 240           | 90-91 | FA134            | FA134R                             | N/A                   |                         |  | FA251               |                                    | MD6126D |                               |  |
| CR 250           | 71-74 | N/A              |                                    |                       |                         |  |                     | 801G                               |         |                               |  |
| CR 250           | 75-79 |                  | 801G                               |                       |                         |  |                     | 801G                               |         |                               |  |
| CR 250           | 80-81 |                  | 802G                               |                       |                         |  |                     | 801G                               |         |                               |  |
| CR 250           | 82-84 |                  | 803G                               |                       |                         |  |                     | 801G                               |         |                               |  |
| CR 250           | 85-86 | FA47TT           | FA47R                              | N/A                   |                         |  |                     | 802G                               |         |                               |  |
| CR 250           | 87-88 | FA134            | FA134R                             | N/A                   |                         |  |                     | 802G                               |         |                               |  |
| CR 250           | 91    | FA134            | FA134R                             | N/A                   |                         |  | FA251               |                                    | MD6126D |                               |  |
| CR 250           | 92-94 | FA135TT          | FA135R■                            | MD6125D               |                         |  | FA84TT              | FA84R                              | MD6126D |                               |  |
| CR 250           | 95-99 | FA181TT          | FA181R■                            | MD6125D               |                         |  | FA208TT             | FA208R■                            | MD6126D |                               |  |
| CR 250           | 00-01 | FA181TT          | FA181R■                            | MD6184D               |                         |  | FA208TT             | FA208R■                            | MD6287D |                               |  |
| CR 250           | 02-04 | FA181TT          | FA181R■                            | MD6184D               |                         |  | FA208TT             | FA208R■                            | MD6295D |                               |  |
| CR 250           | 05    | FA181TT          | FA181R■                            | MD6184D               |                         |  | FA368TT             | FA368R■                            | MD6295D |                               |  |
| TC 250           | 02-03 | FA181TT          | FA181R■                            | MD6184D               |                         |  | FA208TT             | FA208R■                            | MD6295D |                               |  |
| TC 250           | 05-07 | FA181TT          | FA181R■                            | MD6184D               |                         |  | FA368TT             | FA368R■                            | MD6288D |                               |  |
| TE 250           | 02-05 | FA181TT          | FA181R■                            | MD6184D               |                         |  | FA208TT             | FA208R■                            | MD6295D |                               |  |
| TE 250           | 06-07 | FA181TT          | FA181R■                            | MD6184D               |                         |  | FA368TT             | FA368R■                            | MD6288D |                               |  |
| WR 250           | 71-74 | N/A              |                                    |                       |                         |  |                     | 801G                               |         |                               |  |
| WR 250           | 75-78 |                  | 801G                               |                       |                         |  |                     | 801G                               |         |                               |  |
| WR 250           | 80-81 |                  | 802G                               |                       |                         |  |                     | 802G                               |         |                               |  |
| WR 250           | 82-84 |                  | 803G                               |                       |                         |  |                     | 802G                               |         |                               |  |
| WR 250           | 87-88 | FA134            | FA134R                             | N/A                   |                         |  |                     | 802G                               |         |                               |  |
| WR 250           | 90-91 | FA134            | FA134R                             | N/A                   |                         |  | FA251               |                                    | MD6126D |                               |  |
| WR 250           | 92-94 | FA135TT          | FA135R■                            | MD6125D               |                         |  | FA84TT              | FA84R■                             | MD6126D |                               |  |
| WR 250           | 95-99 | FA181TT          | FA181R■                            | MD6125D               |                         |  | FA208TT             | FA208R■                            | MD6126D |                               |  |
| WR 250           | 00-01 | FA181TT          | FA181R■                            | MD6184D               |                         |  | FA208TT             | FA208R■                            | MD6287D |                               |  |
| WR 250           | 02-05 | FA181TT          | FA181R■                            | MD6184D               |                         |  | FA208TT             | FA208R■                            | MD6295D |                               |  |
| WR 250           | 06-07 | FA181TT          | FA181R■                            | MD6184D               |                         |  | FA368TT             | FA368R■                            | MD6288D |                               |  |
| XC 250           | 80-81 |                  | 802G                               |                       |                         |  |                     | 802G                               |         |                               |  |
| XC 250           | 82-84 |                  | 803G                               |                       |                         |  |                     | 802G                               |         |                               |  |
| XC 250           | 85-86 | FA47TT           | FA47R                              | N/A                   |                         |  |                     | 801G                               |         |                               |  |
| XC 250           | 87-88 | FA134            | FA134R                             | N/A                   |                         |  |                     | 802G                               |         |                               |  |
| WR 260           | 90-91 | FA134            | FA134R                             | N/A                   |                         |  | FA251               |                                    | MD6126D |                               |  |
| TE 350           | 90-91 | FA134            | FA134R                             | N/A                   |                         |  | FA251               |                                    | MD6126D |                               |  |
| TE 350           | 92-94 | FA135TT          | FA135R■                            | MD6125D               |                         |  | FA84TT              | FA84R■                             | MD6126D |                               |  |
| TE 350           | 95-97 | FA181TT          | FA181R■                            | MD6125D               |                         |  | FA208TT             | FA208R■                            | MD6126D |                               |  |
| 360 Automatic    | 75-77 | N/A              |                                    |                       |                         |  |                     | 801G                               |         |                               |  |
| CR 360           | 75-78 |                  | 801G                               |                       |                         |  |                     | 801G                               |         |                               |  |
| CR 360           | 92-94 | FA135TT          | FA135R■                            | MD6125D               |                         |  | FA84TT              | FA84R■                             | MD6126D |                               |  |
| WR 360           | 75-78 |                  | 801G                               |                       |                         |  |                     | 801G                               |         |                               |  |
| WR 360           | 92-94 | FA135TT          | FA135R■                            | MD6125D               |                         |  | FA84TT              | FA84R■                             | MD6126D |                               |  |
| WR 360           | 95-99 | FA181TT          | FA181R■                            | MD6125D               |                         |  | FA208TT             | FA208R■                            | MD6126D |                               |  |
| WR 360           | 00-01 | FA181TT          | FA181R■                            | MD6184D               |                         |  | FA208TT             | FA208R■                            | MD6287D |                               |  |
| WR 360           | 02    | FA181TT          | FA181R■                            | MD6184D               |                         |  | FA208TT             | FA208R■                            | MD6295D |                               |  |
| ACC 390          | 80-81 |                  | 801G                               |                       |                         |  |                     | 801G                               |         |                               |  |
| ACCE 390         | 80-81 |                  | 801G                               |                       |                         |  |                     | 801G                               |         |                               |  |
| CR 390           | 75-79 |                  | 801G                               |                       |                         |  |                     | 801G                               |         |                               |  |
| CR 390           | 80-81 |                  | 801G                               |                       |                         |  |                     | 801G                               |         |                               |  |
| CR 390 Automatic | 78    |                  | 801G                               |                       |                         |  |                     | 801G                               |         |                               |  |
| WR 390           | 78    |                  | 801G                               |                       |                         |  |                     | 801G                               |         |                               |  |
| CR 400           | 71-74 |                  | 801G                               |                       |                         |  |                     | 801G                               |         |                               |  |
| SM 400 R         | 02    | FA95             | FA95HH                             | MD6293D               |                         |  | FA208TT             | FA208R■                            | MD6295D |                               |  |

\*-2 Sets Required. ■ - Also available in MX-S race compound, see page 8. ✖ - Oversize and Supermoto disc available - see page 301.

**SAFETY WARNING-** DO NOT USE HH PADS ON REAR UNLESS ALSO USED ON FRONT TO AVOID BRAKE IMBALANCE.

**R** Suffix = High Durability Sintered Pad. **HH** Suffix = High Performance Sintered Pad. **G** Suffix = Grooved Shoe.  
**D** Suffix = Drilled Disc. **C** Suffix = Contoured Disc. **LS** Suffix = Left/Steel Disc. **RS** = Right/Steel Disc.

**BRAKE APPLICATIONS**

# Non-Japanese Built Motorcycles/Quads



HUSQVARNA contd.



| Front/Avant/Vorn                   |                   | Frente/Anteriore    |  |                                    | Rear/Arrière/Hinten           |   | Posterior/Posteriore |   |
|------------------------------------|-------------------|---------------------|--|------------------------------------|-------------------------------|---|----------------------|---|
| 1                                  | 2                 | 3                   | 4  | 5                                  | 6                             | 7 | 8                    | 9 |
| Sintered/HH Pads/<br>Grooved shoes | Left/Gauche/Links | Right/Droite/Rechts | Contour Rotor<br>Universal left and<br>right fitment | Sintered/HH Pads/<br>Grooved shoes | Contour Rotor<br>Rear fitment |   |                      |   |

|                              |       |         |           |         |  |  |         |         |         |
|------------------------------|-------|---------|-----------|---------|--|--|---------|---------|---------|
| TE 400                       | 02    | FA181TT | FA181R■   | MD6184D |  |  | FA208TT | FA208R■ | MD6295D |
| WR 400                       | 75-78 |         | 801G      |         |  |  |         | 801G    |         |
| WR 400                       | 87-88 | FA134   | FA134R    | N/A     |  |  |         | 802G    |         |
| TE 410                       | 95-99 | FA181TT | FA181R■   | MD6125D |  |  | FA208TT | FA208R■ | MD6126D |
| TE 410                       | 00    | FA181TT | FA181R■   | MD6184D |  |  | FA208TT | FA208R■ | MD6287D |
| TE 410                       | 06    | FA181TT | FA181R■   | MD6184D |  |  | FA368TT | FA368R■ | MD6288D |
| TE 410 E                     | 00    | FA181TT | FA181R■   | MD6184D |  |  | FA208TT | FA208R■ | MD6126D |
| 430 Automatic                | 87-88 | FA134   | FA134R    | N/A     |  |  |         | 802G    |         |
| CR 430                       | 80-81 |         | 802G      |         |  |  |         | 801G    |         |
| CR 430                       | 87-88 | FA134   | FA134R    | N/A     |  |  |         | 802G    |         |
| WR 430                       | 80-81 |         | 802G      |         |  |  |         | 802G    |         |
| WR 430                       | 87-88 | FA134   | FA134R    | N/A     |  |  |         | 802G    |         |
| WR-E 430                     | 80-81 |         | 802G      |         |  |  |         | 802G    |         |
| WR-E 430                     | 82-84 |         | 803G      |         |  |  |         | 802G    |         |
| WRU 430                      | 82-84 |         | 803G      |         |  |  |         | 802G    |         |
| XC 430                       | 80-81 |         | 802G      |         |  |  |         | 802G    |         |
| XC 430                       | 87-88 | FA134   | FA134R    | N/A     |  |  |         | 802G    |         |
| CR 450                       | 71-74 |         | 801G      |         |  |  |         | 801G    |         |
| SM 450 R                     | 03-06 | FA95    | FA95HH    | MD6293D |  |  | FA208TT | FA208R■ | MD6295D |
| SMR 450 RR (Radial caliper)  | 06-07 | FA322   | FA322HH   | MD6293D |  |  | FA368TT | FA368R■ | MD6288D |
| SM 450 R Radial caliper      | 07    |         | FA322/4HH | MD6293D |  |  | FA368TT | FA368R■ | MD6288D |
| TC 450                       | 03    | FA181TT | FA181R■   | MD6184D |  |  | FA208TT | FA208R■ | MD6295D |
| TC 450                       | 05-07 | FA181TT | FA181R■   | MD6184D |  |  | FA368TT | FA368R■ | MD6288D |
| TE 450                       | 03-05 | FA181TT | FA181R■   | MD6184D |  |  | FA208TT | FA208R■ | MD6295D |
| TE 450                       | 06-07 | FA181TT | FA181R■   | MD6184D |  |  | FA368TT | FA368R■ | MD6288D |
| WR 450                       | 71-72 |         | 801G      |         |  |  |         | 801G    |         |
| AE 500                       | 82-84 |         | 803G      |         |  |  |         | 802G    |         |
| CR 500                       | 82-84 |         | 803G      |         |  |  |         | 801G    |         |
| CR 500                       | 85-86 | FA47TT  | FA47R     | N/A     |  |  |         | 802G    |         |
| CR 500                       | 87-88 | FA134   | FA134R    | N/A     |  |  |         | 802G    |         |
| XC 500                       | 82-84 |         | 803G      |         |  |  |         | 802G    |         |
| XC 500                       | 85-86 | FA47TT  | FA47R     | N/A     |  |  |         | 801G    |         |
| XC 500                       | 87-88 | FA134   | FA134R    | N/A     |  |  |         | 802G    |         |
| SM 510 R                     | 06-   | FA95    | FA95HH    | MD6293D |  |  | FA208TT | FA208R■ | MD6295D |
| SM 510 R (Radial caliper)    | 06-07 |         | FA322/4HH | MD6293D |  |  | FA368TT | FA368R■ | MD6288D |
| TC 510                       | 87-88 | FA47TT  | FA47R     | N/A     |  |  |         | 801G    |         |
| TC 510                       | 89-   | FA134   | FA134R    | N/A     |  |  |         | 801G    |         |
| TC 510                       | 90    | FA134   | FA134R    | N/A     |  |  | FA251   |         | MD6126D |
| TC 510                       | 04    | FA181TT | FA181R■   | MD6184D |  |  | FA208TT | FA208R■ | MD6295D |
| TC 510                       | 05-07 | FA181TT | FA181R■   | MD6184D |  |  | FA368TT | FA368R■ | MD6288D |
| TE 510                       | 87-88 | FA47TT  | FA47R     | N/A     |  |  |         | 801G    |         |
| TE 510                       | 89-   | FA134   | FA134R    | N/A     |  |  |         | 801G    |         |
| TE 510                       | 90    | FA134   | FA134R    | N/A     |  |  | FA251   |         | MD6126D |
| TE 510                       | 04-05 | FA181TT | FA181R■   | MD6184D |  |  | FA208TT | FA208R■ | MD6295D |
| TE 510                       | 06-07 | FA181TT | FA181R■   | MD6184D |  |  | FA368TT | FA368R■ | MD6288D |
| TX 510                       | 87-88 | FA47TT  | FA47R     | N/A     |  |  |         | 801G    |         |
| WMX 510                      | 89    | FA134   | FA134R    | N/A     |  |  |         | 801G    |         |
| WXE 510                      | 89    | FA134   | FA134R    | N/A     |  |  |         | 801G    |         |
| SM 570 R (4 bolt front disc) | 01-   | FA95    | FA95HH    | MD6293D |  |  | FA208TT | FA208R■ | MD6287D |
| SM 570 R                     | 02-04 | FA95    | FA95HH    | MD6293D |  |  | FA208TT | FA208R■ | MD6295D |
| TC 570                       | 02-03 | FA181TT | FA181R■   | MD6184D |  |  | FA208TT | FA208R■ | MD6295D |
| TE 570                       | 01    | FA181TT | FA181R■   | MD6184D |  |  | FA208TT | FA208R■ | MD6287D |
| TE 570                       | 02-04 | FA181TT | FA181R■   | MD6184D |  |  | FA208TT | FA208R■ | MD6287D |
| LT 610 (6 bolt front disc)   | 00    | FA244   | FA244HH■  | MD6294D |  |  | FA208TT | FA208R■ | MD6295D |
| SM 610 (6 bolt front disc)   | 98-99 | FA244   | FA244HH■  | MD6294D |  |  | FA208TT | FA208R■ | MD6126D |
| SM 610 R                     | 00    | FA244   | FA244HH■  | MD6184D |  |  | FA208TT | FA208R■ | MD6287D |
| SM 610/S (4 bolt front disc) | 02-06 | FA244   | FA244HH   | MD6293D |  |  | FA208TT | FA208R■ | MD6287D |
| SM 610 S (Radial caliper)    | 06    |         | FA322/4HH | MD6293D |  |  | FA208TT | FA208R■ | MD6288D |
| SM 610 IE                    | 07    |         | FA322/4HH | MD6293D |  |  | FA208TT | FA208R■ | MD6295D |
| TC 610                       | 91    | FA134   | FA134R    | N/A     |  |  | FA251   |         | MD6126D |

\*-2 Sets Required. ■ - Also available in MX-S race compound, see page 8. ✖ - Oversize and Supermoto disc available - see page 301.

**SAFETY WARNING-** DO NOT USE HH PADS ON REAR UNLESS ALSO USED ON FRONT TO AVOID BRAKE IMBALANCE.



# Non-Japanese Built Motorcycles/Quads



**HUSQVARNA** contd.

|             |       | Front/Avant/Vorn |                                    |                       | Frente/Anteriore        |   | Rear/Arrière/Hinten |                                    |         | Posterior/Posteriore          |  |
|-------------|-------|------------------|------------------------------------|-----------------------|-------------------------|---|---------------------|------------------------------------|---------|-------------------------------|--|
|             |       | 1                | 2                                  | 3                     | 4                       | 5   | 6                   | 7                                  | 8       | 9                             |  |
|             |       |                  | Sintered/HH Pads/<br>Grooved shoes | Left/Gauche/Links<br> | Right/Droite/Rechts<br> | Contour Rotor<br>Universal left and right fitment |                     | Sintered/HH Pads/<br>Grooved shoes |         | Contour Rotor<br>Rear fitment |  |
| TC 610      | 92-94 | FA135TT          | FA135R■                            | MD6125D               |                         |   | FA84TT              | FA84R■                             | MD6126D |                               |  |
| TC 610/E    | 95-99 | FA181TT          | FA181R■                            | MD6125D               |                         |   | FA208TT             | FA208R■                            | MD6126D |                               |  |
| TC 610      | 00    | FA181TT          | FA181R■                            | MD6184D               |                         |   | FA208TT             | FA208R■                            | MD6287D |                               |  |
| TE 610      | 91    | FA134            | FA134R                             | N/A                   |                         |   | FA251               |                                    | MD6126D |                               |  |
| TE 610      | 92-94 | FA135TT          | FA135R■                            | MD6125D               |                         |   | FA84TT              | FA84R■                             | MD6126D |                               |  |
| TE 610      | 00    | FA181TT          | FA181R■                            | MD6184D               |                         |   | FA208TT             | FA208R■                            | MD6287D |                               |  |
| TE 610/E    | 95-99 | FA181TT          | FA181R■                            | MD6125D               |                         |   | FA208TT             | FA208R■                            | MD6126D |                               |  |
| TE 610 E    | 00    | FA181TT          | FA181R■                            | MD6184D               |                         |   | FA208TT             | FA208R■                            | MD6126D |                               |  |
| TE 610 E    | 02-03 | FA181TT          | FA181R■                            | MD6184D               |                         |   | FA208TT             | FA208R■                            | MD6287D |                               |  |
| TE 610/E    | 06-07 | FA181TT          | FA181R■                            | MD6184D               |                         |   | FA208TT             | FA208R■                            | MD6287D |                               |  |
| SMR 630     | 06    | FA95             | FA95HH                             | MD6293D               |                         |   | FA208TT             | FA208R■                            | MD6295D |                               |  |
| STR 650 CRC | 07    |                  | FA322/4HH                          | MD6293D               |                         |   | FA208TT             | FA208R■                            | MD6295D |                               |  |

## HYOSUNG

|  |       |         |         |          |          |          |         |           |         |  |
|--|-------|---------|---------|----------|----------|----------|---------|-----------|---------|--|
| Super Cab/Cab Plus/Sense 50/Prima Avanti | 99-06 | FA83TT  | FA83HH  | TBA      |          |          | TBA     |           |         |  |
| SD 50                                    | 00-06 | FA83TT  | FA83HH  | TBA      |          |          | TBA     |           |         |  |
| SF 50 R Rally Prima/Racing               | 00-06 | FA83TT  | FA83HH  | TBA      |          |          | TBA     |           |         |  |
| TE 50                                    | 05-07 | 938*    |         |          |          |          |         | FA282R    | MD6301D |  |
| TE 90                                    | 05-07 | 938*    |         |          |          |          |         | FA282R    | MD6301D |  |
| EZ 100                                   | 99-05 | FA83TT  | FA83HH  | TBA      |          |          | TBA     |           |         |  |
| SF 100 R                                 | 05-06 | FA83TT  | FA83HH  | N/A      |          |          | TBA     |           |         |  |
| TE 100                                   | 05-07 | 938*    |         |          |          |          |         | FA282R    | MD6301D |  |
| FX 110 Midas - ECO/STD                   | 99-02 | S603    |         |          |          |          | S603    |           |         |  |
| FX 110 DLX Midas                         | 99-04 | FA83TT  | FA83HH  | TBA      |          |          | S603    |           |         |  |
| KR 110 Master                            | 04-05 | FA83TT  | FA83HH  | N/A      |          |          | S603    |           |         |  |
| Grand Prix 125                           | 99-04 | FA47    | FA47HH  |          | N/A      |          | 897     |           |         |  |
| Cruise II GA 125 F                       | 99-06 | FA56    |         |          | N/A      |          | S602    |           |         |  |
| Boomer/Exceed 125                        | 02-03 | FA47    | FA47HH  |          | N/A      |          | TBA     |           | N/A     |  |
| Parking brake shoe                       |       | TBA     |         |          |          |          |         |           |         |  |
| Comet 125                                | 02    | FA86    | FA86HH  | TBA      |          |          | TBA     |           |         |  |
| Comet 125/250                            | 04    | FA86    | FA86HH  | N/A      |          |          | FA86    | FA86HH    | N/A     |  |
| Exceed 125 (MS1-125/150)                 | 02-04 | FA47    | FA47HH  | N/A      |          |          | FA86    | FA86HH    | N/A     |  |
| GT 125                                   | 01-07 | FA86    | FA86HH  | MD690LS  |          |          | FA86    | FA86HH    | MD689D  |  |
| GT 125 R                                 | 06-07 | FA86*   | FA86HH* | MD690LS  | MD690RS  |          | FA86    | FA86HH    | MD689D  |  |
| GV 125 Aquilia                           | 01-07 | FA86    | FA86HH  | N/A      |          |          | S602    |           |         |  |
| RT Karion 125                            | 02-07 | FA86    | FA86HH  | MD6067D  |          |          | S602    |           |         |  |
| MS1 125/150                              | 05    | FA47    |         | N/A      |          |          | TBA     |           |         |  |
| RX 125                                   | 01-07 | FA86    | FA86HH  | N/A      |          |          | S602    |           |         |  |
| RX 125 SM                                | 06-07 | FA86    | FA86HH  | TBA      |          |          | FA86    | FA86HH    | TBA     |  |
| XRX 125 Enduro                           | 04-07 | FA86    | FA86HH  | N/A      |          |          | S602    |           |         |  |
| Comet 250                                | 02    | FA129   | FA129HH | N/A      |          |          | FA63    | FA63HH    | TBA     |  |
| GT 250                                   | 04-07 | FA86    | FA86HH  | MD690LS  | MD690RS  |          | FA86    | FA86HH    | MD689D  |  |
| GT 250 R                                 | 06-07 | FA86    | FA86HH  | MD690LS  | MD690RS  |          | FA86    | FA86HH    | MD689D  |  |
| GV 250 Aquilia                           | 01-07 | FA86    | FA86HH  | N/A      |          |          | S605    |           |         |  |
| RX 400                                   | 05    | FA86    | FA86HH  | N/A      |          |          | FA131TT |           | N/A     |  |
| TE 450 Quad                              | 06-07 | FA54TT* | FA54R■  | N/A      | N/A      |          | FA54TT  | FA54R     | N/A     |  |
| Comet 600                                | 02    | FA129   | FA129HH | N/A      |          |          | FA63    | FA63HH    | TBA     |  |
| Comet 650/650 R                          | 04-05 | FA86*   | FA86HH* | N/A      | N/A      |          | FA86    | FA86HH    | TBA     |  |
| GT 650 Sport R                           | 04-07 | FA86*   | FA86HH* | MD690LS  | MD690RS  |          | FA86    | FA86HH    | MD689D  |  |
| GT 650                                   | 06-07 | FA86*   | FA86HH* | MD690LS  | MD690RS  |          | FA86    | FA86HH    | MD689D  |  |
| GT 650 X                                 | 07    | FA86*   | FA86HH* | MD3090LS | MD3090RS | MD3090C* | FA86    | FA86HH    | MD689   |  |
| GT 650 S                                 | 05-07 | FA86*   | FA86HH* | MD690LS  | MD690RS  |          | FA86    | FA86HH    | MD689D  |  |
| GV 650 Aquilia                           | 04-05 | FA86*   | FA86HH* | TBA      | TBA      |          | FA319/2 | FA319/2HH | N/A     |  |
| GV 650                                   | 06-07 | FA86*   | FA86HH* | MD691LS  | MD691RS  |          | FA86    | FA86HH    | N/A     |  |

## ITALJET

|                 |       |       |         |        |  |  |       |         |        |  |
|-----------------|-------|-------|---------|--------|--|--|-------|---------|--------|--|
| Dragster 50 LC  | 98-07 | FA115 | FA115HH | MD941D |  |  | FA115 | FA115HH | MD948D |  |
| Formula 50 LC   | 96-03 | FA115 | FA115HH | MD941D |  |  | FA115 | FA115HH | MD950D |  |
| Formula Air 50  | 99-03 | FA115 | FA115HH | MD941D |  |  | S624  |         |        |  |
| Jet Set 50cc 2T | 02-03 | FA350 |         | TBA    |  |  | 816   |         |        |  |

\*-2 Sets Required. ■ - Also available in MX-S race compound, see page 8. ✖ - Oversize and Supermoto disc available - see page 301.

**SAFETY WARNING-** DO NOT USE HH PADS ON REAR UNLESS ALSO USED ON FRONT TO AVOID BRAKE IMBALANCE.

R Suffix = High Durability Sintered Pad. HH Suffix = High Performance Sintered Pad. G Suffix = Grooved Shoe.  
D Suffix = Drilled Disc. C Suffix = Contoured Disc. LS Suffix = Left/Steel Disc. RS = Right/Steel Disc.

**BRAKE APPLICATIONS**

# Non-Japanese Built Motorcycles/Quads



APPLICATIONS

BRAKE

R Suffix = High Durability Sintered Pad. C Suffix = Contoured Disc. D Suffix = Drilled Disc.

G Suffix = Grooved Shoe. H Suffix = High Performance Sintered Pad. J Suffix = Left/Steel Disc. L Suffix = Right/Steel Disc.

## ITALJET contd.

|                             |       | 1                                  | 2                                  | 3                 | 4                   | 5  | 6                                  | 7                                  | 8                             | 9                             |
|-----------------------------|-------|------------------------------------|------------------------------------|-------------------|---------------------|--|------------------------------------|------------------------------------|-------------------------------|-------------------------------|
|                             |       | Sintered/HH Pads/<br>Grooved shoes | Sintered/HH Pads/<br>Grooved shoes | Left/Gauche/Links | Right/Droite/Rechts | Contour Rotor<br>Universal left and<br>right fitment | Sintered/HH Pads/<br>Grooved shoes | Sintered/HH Pads/<br>Grooved shoes | Contour Rotor<br>Rear fitment | Contour Rotor<br>Rear fitment |
| Velocifero 50               | 98-02 | H350                               |                                    |                   |                     |  | S624                               |                                    |                               |                               |
| Torpedo 50 (All models)     | 98-03 | FA115                              | FA115HH                            | MD951D            |                     |  | S624                               |                                    |                               |                               |
| (All models 125cc)          |       | 965                                | 965G                               |                   |                     |  | 965                                | 965G                               |                               |                               |
| Dragster 125/180 LC         | 99    | FA115                              | FA115HH                            | MD941D            |                     |  | 816                                |                                    |                               |                               |
| Dragster 125/180 LC         | 00-03 | FA115                              | FA115HH                            | MD941D            |                     |  | FA115                              | FA115HH                            | MD949D                        |                               |
| Formula 125 LC              | 96-03 | FA115                              | FA115HH                            | MD941D            |                     |  | FA115                              | FA115HH                            | MD950D                        |                               |
| Jack 125/150                | 07    | FA323                              | FA323HH                            | TBA               |                     |  | FA323                              | FA323HH                            | TBA                           |                               |
| Jet Set 125/150 2T          | 02-03 | FA350                              |                                    | TBA               |                     |  | 816                                |                                    |                               |                               |
| Jupiter 125/150             | 02    | FA199                              | FA199HH                            |                   | MD999D              |  | FA275                              | FA275HH                            | MD953D                        |                               |
| Millennium M 100/125/150 LC | 00-01 | FA101                              |                                    |                   | MD9114D             |  | Y527                               |                                    |                               |                               |
| Millennium M 100/125/150 LC | 02-04 | FA350                              |                                    |                   | MD9114D             |  | Y527                               |                                    |                               |                               |
| Pit Jt 125 4T               | 07    | FA448                              |                                    | N/A               |                     |  | FA448                              |                                    | N/A                           |                               |
| Torpedo 125 4T              | 99-03 | FA115                              | FA115HH                            | MD951D            |                     |  | 816                                |                                    |                               |                               |
| Torpedo 125                 | 07    | FA323                              | FA323HH                            | N/A               |                     |  | S624                               |                                    |                               |                               |
| Dragster 250                | 07    | FA115                              | FA115HH                            | MD941D            |                     |  | FA115                              | FA115HH                            | MD948D                        |                               |
| Jupiter 250                 | 02-03 | FA199                              | FA199HH                            |                   | MD999D              |  | FA374                              |                                    | MD953D                        |                               |
| Bazooka (650cc)             | 06    | FA86*                              | FA86HH*                            | N/A               | N/A                 |  | FA86                               | FA86HH                             | N/A                           |                               |
| Grifon #59 (650cc)          | 06    | FA86*                              | FA86HH*                            | N/A               |                     |  | FA86                               | FA86HH                             | N/A                           |                               |
| Grifon # 59                 | 07    | TBA*                               |                                    | TBA               | TBA                 |  | FA209/2                            | FA209/2HH                          | TBA                           |                               |

## JIALING

|                   |    |        |        |  |     |  |     |  |  |  |
|-------------------|----|--------|--------|--|-----|--|-----|--|--|--|
| JL 50 Stylish     | 98 | TBA    |        |  |     |  | TBA |  |  |  |
| JH 50 III Street  | 98 | TBA    |        |  |     |  | TBA |  |  |  |
| JL 70 Horizon     | 98 | TBA    |        |  |     |  | TBA |  |  |  |
| JD 90 Freedom     | 98 | TBA    |        |  |     |  | TBA |  |  |  |
| JH 125 Roadstar   | 98 | TBA    |        |  |     |  | TBA |  |  |  |
| JH 125 B Roadstar | 98 | FA54TT |        |  | TBA |  | TBA |  |  |  |
| JE 125 E Dragon   | 98 | FA86   | FA86HH |  | TBA |  | TBA |  |  |  |

## JCM

|              |    |       |        |     |  |  |         |        |     |  |
|--------------|----|-------|--------|-----|--|--|---------|--------|-----|--|
| 240 'Europa' | 89 | FA115 | FA115R | N/A |  |  | FA337TT | FA337R | N/A |  |
|--------------|----|-------|--------|-----|--|--|---------|--------|-----|--|

## J. J. COBAS

|       |     |       |        |     |  |  |       |        |     |  |
|-------|-----|-------|--------|-----|--|--|-------|--------|-----|--|
| TR1   | 85- | FA95  | FA95HH | N/A |  |  | FA115 | FA115R | N/A |  |
| Trial | 85- | FA115 | FA115R | N/A |  |  | N/A   |        |     |  |

## JORDAN

|  |       |       |        |        |     |  |         |        |     |  |
|--|-------|-------|--------|--------|-----|--|---------|--------|-----|--|
| Easy 50/100                                | 03-04 | FA169 |        | MD904D |     |  | Y503    |        |     |  |
| Hipo/Mars/Bob 50/90/100 Anti Vibrate Model | 03-04 | H338* | H338G* |        |     |  | FA232TT | FA232R | N/A |  |
| Hipo/Mars/Bob 50/90/100 Street Model       | 03-04 | H338* | H338G* |        |     |  | FA232TT | FA232R | N/A |  |
| Panther 125/150/250                        | 03-04 | TBA*  |        | TBA    | TBA |  | TBA     |        | TBA |  |
| Rino 125/150/250                           | 03-04 | TBA*  |        | TBA    | TBA |  | TBA     |        | TBA |  |

## KAWATA

|             |       |       |  |     |     |  |     |  |  |  |
|-------------|-------|-------|--|-----|-----|--|-----|--|--|--|
| Fever 50/90 | 99-01 | FA169 |  | TBA | TBA |  | TBA |  |  |  |
| Nightfly 50 | 99-01 | TBA   |  | TBA | TBA |  | TBA |  |  |  |
| Stinger 90  | 99-01 | FA169 |  | TBA | TBA |  | TBA |  |  |  |
| Falcon 125  | 99-01 | TBA   |  | TBA | TBA |  | TBA |  |  |  |

## KEEWAY

|                    |    |        |         |        |  |  |      |  |     |  |
|--------------------|----|--------|---------|--------|--|--|------|--|-----|--|
| Focus 25/50        | 07 | FA83TT | FA83HH  | TBA    |  |  | Y503 |  |     |  |
| Matrix 25/50       | 06 | FA83TT | FA83HH  | MD909D |  |  | TBA  |  |     |  |
| F-Act 50           | 07 | FA235  |         | TBA    |  |  | TBA  |  |     |  |
| Flash 50           | 07 | FA235  |         | TBA    |  |  | TBA  |  |     |  |
| Hurricane 50       | 07 | FA83TT | FA83HH  | TBA    |  |  | Y503 |  |     |  |
| Hurricane 50-Base  | 07 | FA83TT | FA83HH  | TBA    |  |  | Y503 |  |     |  |
| Matrix 50          | 07 | FA235  |         | TBA    |  |  | TBA  |  |     |  |
| X-Ray 50 Supermoto | 07 | FA194  | FA194HH | N/A    |  |  | FA60 |  | N/A |  |
| ARN 125            | 07 | FA47   | FA47HH  | TBA    |  |  | Y506 |  |     |  |
| Focus 125          | 07 | FA83TT | FA83HH  | TBA    |  |  | Y506 |  |     |  |

\*-2 Sets Required. ■ - Also available in MX-S race compound, see page 8. ✖ - Oversize and Supermoto disc available - see page 301.

**SAFETY WARNING-** DO NOT USE HH PADS ON REAR UNLESS ALSO USED ON FRONT TO AVOID BRAKE IMBALANCE.

# Non-Japanese Built Motorcycles/Quads



## KEEWAY contd.

|                         |    | Front/Avant/Vorn |                                |                   | Frente/Anteriore    |  | Rear/Arrière/Hinten |                                |     | Posterior/Posteriore       |  |
|-------------------------|----|------------------|--------------------------------|-------------------|---------------------|--|---------------------|--------------------------------|-----|----------------------------|--|
|                         |    | 1                | 2                              | 3                 | 4                   | 5  | 6                   | 7                              | 8   | 9                          |  |
|                         |    |                  | Sintered/HH Pads/Grooved shoes | Left/Gauche/Links | Right/Droite/Rechts | Contour Rotor Universal left and right fitment |                     | Sintered/HH Pads/Grooved shoes |     | Contour Rotor Rear fitment |  |
| K2 125/150/250          | 07 | FA353            |                                | TBA               |                     |  | FA353               |                                | TBA |                            |  |
| Matrix 125              | 06 | FA83TT           | FA83HH                         | MD909D            |                     |  | Y506                |                                |     |                            |  |
| Matrix 125              | 07 | FA235            |                                | TBA               |                     |  | TBA                 |                                |     |                            |  |
| Outlook 125/150         | 07 | FA228            | FA228HH                        | N/A               |                     |  | FA228               | FA228HH                        | N/A |                            |  |
| Silverblade 125/150/250 | 07 | FA181TT*         | FA181HH*                       | TBA               | TBA                 |  | FA266               | FA266HH                        | TBA |                            |  |
| Speed 125               | 07 | FA93             |                                | N/A               |                     |  | TBA                 |                                |     |                            |  |
| Superlight 125          | 07 | FA228            | FA228HH                        | TBA               |                     |  | TBA                 |                                |     |                            |  |
| Dragon 250 "Quad"       | 07 | FA83TT*          | FA83R*                         | N/A               | N/A                 |  | FA54TT              | FA54R                          | N/A |                            |  |
| RY8                     | 07 | TBA              |                                | TBA               |                     |  | Y503                |                                |     |                            |  |

## K.M. (Keemotorbikes)

|               |    |       |  |     |  |  |      |  |  |  |
|---------------|----|-------|--|-----|--|--|------|--|--|--|
| Badboy 50 CX  | 05 | FA235 |  | N/A |  |  | H303 |  |  |  |
| Badboy 100 CX | 05 | FA235 |  | N/A |  |  | H303 |  |  |  |

## KRAM-IT (KRAMER)

|                    |     |         |         |     |  |  |         |         |     |  |
|--------------------|-----|---------|---------|-----|--|--|---------|---------|-----|--|
| MC 125 LC          |     |         |         |     |  |  |         |         |     |  |
| EP 250/EC 250      |     |         |         |     |  |  |         | 843WG   |     |  |
| GS 250             | 00- | FA181TT | FA181R■ | N/A |  |  | FA208TT | FA208R■ | N/A |  |
| MC 250/MC 250 LC   |     |         |         |     |  |  |         | 843WG   |     |  |
| SM 250             | 00- | FA181TT | FA181R■ | N/A |  |  | FA208TT | FA208R■ | N/A |  |
| SMR 250            | 00- | TBA     |         |     |  |  | FA208TT | FA208R  | N/A |  |
| EC 450/MC 450      |     |         |         |     |  |  |         | 843WG   |     |  |
| MC 500             |     |         |         |     |  |  |         | 843WG   |     |  |
| ER 125/250/300 RV3 | 88- | FA134   | FA134R  | N/A |  |  | FA67/3  | FA67R   | N/A |  |
| ER 500/600         | 96- | FA134   | FA134R  | N/A |  |  | FA67/3  | FA67R   | N/A |  |

## KREIDLER

|                      |  |      |  |     |     |  |      |  |  |  |
|----------------------|--|------|--|-----|-----|--|------|--|--|--|
| 50 MF2               |  | H322 |  |     |     |  | H322 |  |  |  |
| 50 MF4 Early Models  |  | 908  |  |     |     |  | 908  |  |  |  |
| 50 MF4 Later Models  |  | H322 |  |     |     |  | H322 |  |  |  |
| 50 Flory MF 12/13    |  | 932  |  |     |     |  | 932  |  |  |  |
| 50 Flory MF 20/22    |  | H322 |  |     |     |  | H322 |  |  |  |
| 50 Flory MF 23/24/25 |  | 932  |  |     |     |  | 932  |  |  |  |
| 50 MP1 Early Models  |  | 908  |  |     |     |  | 908  |  |  |  |
| 50 MP1 Later Models  |  | H322 |  |     |     |  | H322 |  |  |  |
| 50 RM                |  | 966  |  |     |     |  | 966  |  |  |  |
| 50 LH/LF/LFF         |  | 932  |  |     |     |  | 932  |  |  |  |
| 50 RMC/RMC-BG        |  | 932  |  |     |     |  | 932  |  |  |  |
| RS Typ K 54/53       |  | 869  |  |     |     |  | 869  |  |  |  |
| RSH Typ K54/53H      |  | 869  |  |     |     |  | 869  |  |  |  |
| 50 RS-G/RSH-G and GS |  | FA56 |  |     | N/A |  | TBA  |  |  |  |
| 80 E/L Florett       |  | FA56 |  |     | N/A |  | 966  |  |  |  |
| Mustang 125          |  | FA76 |  | N/A |     |  | 932  |  |  |  |
| 125                  |  | 967  |  |     |     |  | 932  |  |  |  |
| 125 RS               |  | FA56 |  | N/A |     |  | 932  |  |  |  |

## KTM

|                                       |       |         |        |         |  |          |         |        |         |         |
|---------------------------------------|-------|---------|--------|---------|--|----------|---------|--------|---------|---------|
| 50 Supermoto                          | 06    | FA325TT | FA325R | N/A     |  |          | FA325TT | FA325R | N/A     |         |
| 50 SX/SXR Pro Junior/Senior/Adventure | 96-03 | H322    |        |         |  |          | H322    |        |         |         |
| 50 SX Mini Adventure                  | 04-07 | H322    |        |         |  |          | H322    |        |         |         |
| 50 SX Pro Senior LC                   | 02-03 | FA325TT | FA325R | N/A     |  |          | H322    |        |         |         |
| 50 SX Senior Adventure                | 02-07 | FA325TT | FA325R | N/A     |  |          | H322    |        |         |         |
| 50 SX Pro Senior LC                   | 04-06 | FA325TT | FA325R | N/A     |  |          | FA325TT | FA325R | N/A     |         |
| 60 SX                                 | 98-99 | FA115   | FA115R | MD6192D |  | MD6192C  | 815     |        |         |         |
| 60 SX                                 | 00    | FA115   | FA115R | MD6192D |  | MD6192C  | FA337TT | FA337R | MD6216D |         |
| 65 SX                                 | 00-01 | FA115   | FA115R | MD6192D |  | MD6192C  | FA337TT | FA337R | MD6216D |         |
| 65 SX                                 | 02-03 | FA357TT | FA357R | MD6192D |  | MD6192C  | FA337TT | FA337R | MD6216D |         |
| 65 SX                                 | 04-07 | FA357TT | FA357R | MD6243D |  | MD6243C  | FA325TT | FA325R |         | MD6249C |
| 80 MX                                 | 86-92 | FA47/2  |        | N/A     |  |          | 814G    |        |         |         |
| SX 85                                 | 03-07 | FA357TT | FA357R |         |  | MD6258C* | FA357TT | FA357R |         | MD6257C |

\*-2 Sets Required. ■ - Also available in MX-S race compound, see page 8. ✖ - Oversize and Supermoto disc available - see page 301.

**SAFETY WARNING-** DO NOT USE HH PADS ON REAR UNLESS ALSO USED ON FRONT TO AVOID BRAKE IMBALANCE.

**R** Suffix = High Durability Sintered Pad. **HH** Suffix = High Performance Sintered Pad. **G** Suffix = Grooved Shoe.  
**D** Suffix = Drilled Disc. **C** Suffix = Contoured Disc. **LS** Suffix = Left/Steel Disc. **RS** = Right/Steel Disc.

**BRAKE APPLICATIONS**

# Non-Japanese Built Motorcycles/Quads



KTM contd.

|  |       | Front/Avant/Vorn |                                |                   | Frente/Anteriore    |  | Rear/Arrière/Hinten |                                |         | Posterior/Posteriore       |  |
|--|-------|------------------|--------------------------------|-------------------|---------------------|--|---------------------|--------------------------------|---------|----------------------------|--|
|  |       | 1                | 2                              | 3                 | 4                   | 5  | 6                   | 7                              | 8       | 9                          |  |
|  |       |                  | Sintered/HH Pads/Grooved shoes | Left/Gauche/Links | Right/Droite/Rechts | Contour Rotor Universal left and right fitment |                     | Sintered/HH Pads/Grooved shoes |         | Contour Rotor Rear fitment |  |
| 125/175                                    | -84   |                  | 812WG                          |                   |                     |  |                     | 812WG                          |         |                            |  |
| 125 GS                                     | 83    |                  | 811WG                          |                   |                     |  |                     | 812WG                          |         |                            |  |
| D-XC/E-XC/E-GS 125                         | 90-91 | FA67TT           | FA67R                          | MD6034D           |                     |  | FA67TT              | FA67R                          | N/A     |                            |  |
| D-XC/E-XC/E-GS 125 Grimeca Calipers        | 90-91 | FA132            | FA132R                         | MD6034D           |                     |  | FA132               | FA132R                         | N/A     |                            |  |
| D-XC/E-XC/E-GS 125 Brembo Calipers         | 92-93 | FA181TT          | FA181R                         | MD6034D           |                     |  | FA67TT              | FA67R                          | N/A     |                            |  |
| D-XC/E-XC/E-GS 125 Grimeca Calipers        | 92-93 | FA132            | FA132R                         | MD6034D           |                     |  | FA67TT              | FA67R                          | N/A     |                            |  |
| EXC 125                                    | 87    | FA126TT          | FA126R                         | N/A               |                     |  | FA126TT             | FA126R                         | N/A     |                            |  |
| EXC 125                                    | 88    | FA132            | FA132R                         | N/A               |                     |  | FA132               | FA132R                         | MD6227D |                            |  |
| EXC 125 Brembo Calipers                    | 89    | FA67TT           | FA67R                          | MD6034D           |                     |  | FA67TT              | FA67R                          | MD6227D |                            |  |
| EXC 125 Grimeca Calipers                   | 89    | FA132            | FA132R                         | MD6034D           |                     |  | FA132               | FA132R                         | MD6227D |                            |  |
| EXC/EGS 125 (standard forks)               | 94    | FA181TT          | FA181R                         | MD6032D           |                     | MD6032C  | FA208TT             | FA208R                         | MD6035D | MD6035C                    |  |
| EXC 125 (Standard forks)                   | 95-99 | FA181TT          | FA181R                         | MD6032D           |                     | MD6032C  | FA208TT             | FA208R                         | MD6035D | MD6035C                    |  |
| EXC 125 (Upside down forks)                | 00-03 | FA181TT          | FA181R                         | MD6032D           |                     | MD6032C  | FA208TT             | FA208R                         | MD6035D | MD6035C                    |  |
| EXC 125 (Upside down forks)                | 04-07 | FA181TT          | FA181R                         | MD6032D           |                     | MD6032C  | FA368TT             | FA368R                         | MD6035D | MD6035C                    |  |
| EXE 125                                    | 00    | FA181TT          | FA181R                         | MD6032D           |                     | MD6032C  | FA208TT             | FA208R                         | MD6035D | MD6035C                    |  |
| GSXC/GS 125                                | 85    | FA47TT           | FA47R                          | N/A               |                     |  |                     | 814G                           |         |                            |  |
| LC2 125                                    | 96-98 | FA181TT          | FA181R                         | N/A               |                     |  | FA208TT             | FA208R                         | N/A     |                            |  |
| Sting 125                                  | 97-99 | FA95             | FA95HH                         | N/A               |                     |  | FA208TT             | FA208R                         | N/A     |                            |  |
| MX 125                                     | 83    |                  | 811G                           |                   |                     |  |                     | 812G                           |         |                            |  |
| MX 125                                     | 84    |                  | 814G                           |                   |                     |  |                     | 814G                           |         |                            |  |
| MX/MXC 125                                 | 85    | FA47TT           | FA47R                          | N/A               |                     |  |                     | 814G                           |         |                            |  |
| MX/MXC/GS 125                              | 86    | FA47TT           | FA47R                          | N/A               |                     |  | FA47TT              | FA47R                          | MD6227D |                            |  |
| MX 125                                     | 87    | FA126            | FA126R                         | N/A               |                     |  | FA126               | FA126R                         | N/A     |                            |  |
| MX 125                                     | 88    | FA132            | FA132R                         |                   |                     |  | FA132               | FA132R                         | MD6227D |                            |  |
| MX 125 Brembo Calipers                     | 89    | FA67TT           | FA67R                          | N/A               |                     |  | FA67TT              | FA67R                          | MD6227D |                            |  |
| MX 125 Grimeca Calipers                    | 89    | FA132            | FA132R                         | N/A               |                     |  | FA132               | FA132R                         | MD6227D |                            |  |
| MX 125 Brembo Calipers                     | 90-91 | FA67TT           | FA67R                          | N/A               |                     |  | FA67TT              | FA67R                          | N/A     |                            |  |
| MX 125 Grimeca Calipers                    | 90-91 | FA132            | FA132R                         | N/A               |                     |  | FA132               | FA132R                         | N/A     |                            |  |
| MX 125 Brembo Calipers                     | 92-93 | FA181TT          | FA181R                         | MD6032D           |                     | MD6032C  | FA67TT              | FA67R                          | N/A     |                            |  |
| MX 125 Grimeca Calipers                    | 92-93 | FA132            | FA132R                         | MD6032D           |                     | MD6032C  | FA67TT              | FA67R                          | N/A     |                            |  |
| SM 125 Supermoto                           | 00    | FA181TT          | FA181R                         | TBA               |                     |  | FA208TT             | FA208R                         | MD6035D | MD6035C                    |  |
| SX 125 (Standard forks)                    | 94-99 | FA181TT          | FA181R                         | MD6032D           |                     | MD6032C  | FA208TT             | FA208R                         | MD6035D | MD6035C                    |  |
| SX 125 (Upside down forks)                 | 00-03 | FA181TT          | FA181R                         | MD6032D           |                     | MD6032C  | FA208TT             | FA208R                         | MD6035D | MD6035C                    |  |
| SX 125 (Upside down forks)                 | 04-07 | FA181TT          | FA181R                         | MD6032D           |                     | MD6032C  | FA368TT             | FA368R                         | MD6035D | MD6035C                    |  |
| EXC/EGS 200 (Standard forks)               | 98-99 | FA181TT          | FA181R                         | MD6032D           |                     | MD6032C  | FA208TT             | FA208R                         | MD6035D | MD6035C                    |  |
| EXC/EGS 200 (Upside down forks)            | 00-03 | FA181TT          | FA181R                         | MD6032D           |                     | MD6032C  | FA208TT             | FA208R                         | MD6035D | MD6035C                    |  |
| EXC 200 (Upside down forks)                | 04-07 | FA181TT          | FA181R                         | MD6032D           |                     | MD6032C  | FA368TT             | FA368R                         | MD6035D | MD6035C                    |  |
| 250  | -82   |                  | 812G                           |                   |                     |  |                     | 813G                           |         |                            |  |
| 250 MX Leleu                               | 82    |                  | 811WG                          |                   |                     |  |                     | 813WG                          |         |                            |  |
| 250 MX                                     | 83    |                  | TBA                            |                   |                     |  |                     | TBA                            |         |                            |  |
| 250 XC/GS                                  | 83    |                  | 811WG                          |                   |                     |  |                     | 813WG                          |         |                            |  |
| DXC/EXC 250 Grimeca Calipers               | 90    | FA132            | FA132R                         | MD6034D           |                     |  | FA132               | FA132R                         | N/A     |                            |  |
| D-XC/E-XC/E-GS 250 Brembo Calipers         | 91    | FA67TT           | FA67R                          | MD6034D           |                     |  | FA67                | FA67R                          | N/A     |                            |  |
| D-XC/E-XC/E-GS 250                         | 91    | FA132            | FA132R                         | MD6034D           |                     |  | FA132               | FA132R                         | N/A     |                            |  |
| D-XC/E-XC/T-XC/E-GS 250 (Grimeca calipers) | 92-93 | FA132            | FA132R                         | MD6032D           |                     | MD6032C  | FA67                | FA67R                          | N/A     |                            |  |
| EXC/EGS 250                                | 88    | FA132            | FA132R                         | N/A               |                     |  | FA132               | FA132R                         | MD6227D |                            |  |
| EXC/EGS 250 Brembo Calipers                | 89    | FA67TT           | FA67R                          | MD6034D           |                     |  | FA67                | FA67R                          | MD6227D |                            |  |
| EXC/EGS 250 Grimeca Calipers               | 89    | FA132            | FA132R                         | MD6034D           |                     |  | FA132               | FA132R                         | MD6227D |                            |  |
| EXC/EGS 250 (Standard forks)               | 94    | FA181TT          | FA181R                         | MD6032D           |                     | MD6032C  | FA208TT             | FA208R                         | MD6035D | MD6035C                    |  |
| EXC 250 (Standard forks)                   | 95-99 | FA181TT          | FA181R                         | MD6032D           |                     | MD6032C  | FA208TT             | FA208R                         | MD6035D | MD6035C                    |  |
| EXC 250 (Upside down forks)                | 00-03 | FA181TT          | FA181R                         | MD6032D           |                     | MD6032C  | FA208TT             | FA208R                         | MD6035D | MD6035C                    |  |
| EXC 250 (Upside down forks)                | 04-07 | FA181TT          | FA181R                         | MD6032D           |                     | MD6032C  | FA368TT             | FA368R                         | MD6035D | MD6035C                    |  |
| EXC 250 Racing                             | 06    | FA181TT          | FA181R                         | MD6032D           |                     | MD6032C  | FA368TT             | FA368R                         | MD6035D | MD6035C                    |  |
| EXC-F 250                                  | 06-07 | FA181TT          | FA181R                         | MD6032D           |                     | MD6032C  | FA368TT             | FA368R                         | MD6032D | MD6032C                    |  |
| GS 250                                     | 86    | FA47             | FA47R                          | N/A               |                     |  | FA47                | FA47R                          | MD6227D |                            |  |
| GSXC/GS 250                                | 85    | FA47             | FA47R                          | N/A               |                     |  |                     | 814G                           |         |                            |  |
| MX 250                                     | 88    | FA132            | FA132R                         | N/A               |                     |  | FA132               | FA132R                         | MD6227D |                            |  |
| MX 250 Grimeca Calipers                    | 89    | FA132            | FA132R                         | N/A               |                     |  | FA132               | FA132R                         | MD6227D |                            |  |
| MX 250 Brembo Calipers                     | 89    | FA67TT           | FA67R                          | N/A               |                     |  | FA67                | FA67R                          | MD6227D |                            |  |
| MX 250 Brembo Calipers                     | 90    | FA67TT           | FA67R                          | N/A               |                     |  | FA67                | FA67R                          | N/A     |                            |  |

\*-2 Sets Required. ■ - Also available in MX-S race compound, see page 8. ✖ - Oversize and Supermoto disc available - see page 301.

**SAFETY WARNING-** DO NOT USE HH PADS ON REAR UNLESS ALSO USED ON FRONT TO AVOID BRAKE IMBALANCE.

# Non-Japanese Built Motorcycles/Quads



KTM contd.

|                                  |       | Front/Avant/Vorn |                                    |                       | Frente/Anteriore        |  | Rear/Arrière/Hinten |                                    |         | Posterior/Posteriore          |  |
|----------------------------------|-------|------------------|------------------------------------|-----------------------|-------------------------|--|---------------------|------------------------------------|---------|-------------------------------|--|
|                                  |       | 1                | 2                                  | 3                     | 4                       | 5  | 6                   | 7                                  | 8       | 9                             |  |
|                                  |       |                  | Sintered/HH Pads/<br>Grooved shoes | Left/Gauche/Links<br> | Right/Droite/Rechts<br> | Contour Rotor<br>Universal left and<br>right fitment |                     | Sintered/HH Pads/<br>Grooved shoes |         | Contour Rotor<br>Rear fitment |  |
| MX 250 Brembo Calipers           | 91    | FA67TT           | FA67R                              | N/A                   |                         |  | FA67                | FA67R                              | N/A     |                               |  |
| MX 250 Grimeca Calipers          | 91    | FA132            | FA132R                             | N/A                   |                         |  | FA132               | FA132R                             | N/A     |                               |  |
| MX 250 Brembo Calipers           | 92-93 | FA181TT          | FA181R                             | MD6032D               |                         | MD6032C  | FA67                | FA67R                              | N/A     |                               |  |
| MX/EXC 250                       | 87    | FA126            | FA126R                             | N/A                   |                         |  | FA126               | FA126R                             | N/A     |                               |  |
| MX/MXC/GS 250                    | 84    |                  | 814G                               |                       |                         |  |                     | 814G                               |         |                               |  |
| MX/MXC 250                       | 85    | FA47TT           | FA47R                              | N/A                   |                         |  |                     | 814G                               |         |                               |  |
| MX/MXC 250                       | 86    | FA47TT           | FA47R                              | N/A                   |                         |  | FA47                | FA47R                              | MD6227D |                               |  |
| SX 250 (Standard Forks)          | 94-99 | FA181TT          | FA181R                             | MD6032D               |                         | MD6032C  | FA208TT             | FA208R                             | MD6035D | MD6035C                       |  |
| SX 250 (Upside down forks)       | 00-02 | FA181TT          | FA181R                             | MD6032D               |                         | MD6032C  | FA208TT             | FA208R                             | MD6035D | MD6035C                       |  |
| SX 250 (Upside down forks)       | 03-07 | FA181TT          | FA181R                             | MD6032D               |                         | MD6032C  | FA368TT             | FA368R                             | MD6035D | MD6035C                       |  |
| SX-F 250                         | 06-07 | FA181TT          | FA181R                             | MD6032D               |                         | MD6032C  | FA368TT             | FA368R                             | MD6035D | MD6035C                       |  |
| EXC 300 (Upside down forks)      | 00-03 | FA181TT          | FA181R                             | MD6032D               |                         | MD6032C  | FA208TT             | FA208R                             | MD6035D | MD6035C                       |  |
| EXC 300 (Upside down forks)      | 04-07 | FA181TT          | FA181R                             | MD6032D               |                         | MD6032C  | FA368TT             | FA368R                             | MD6035D | MD6035C                       |  |
| GSXC/GS 300                      | 85    | FA47             | FA47R                              | N/A                   |                         |  |                     | 814G                               |         |                               |  |
| MX/MXC 300                       | 85    | FA47             | FA47R                              | N/A                   |                         |  |                     | 814G                               |         |                               |  |
| MX/MXC/GS 300                    | 86    | FA47             | FA47R                              | N/A                   |                         |  | FA47                | FA47R                              | MD6227D |                               |  |
| 350                              | -82   |                  | 812WG                              |                       |                         |  |                     | 813WG                              |         |                               |  |
| 350 Four Stroke                  | 83    | FA47TT           | FA47R                              | N/A                   |                         |  |                     | 813WG                              |         |                               |  |
| DXC/EXC/EGS 350 Brembo Calipers  | 90-91 | FA67TT           | FA67R                              | MD6034D               |                         |  | FA67                | FA67R                              | N/A     |                               |  |
| DXC/EXC/EGS 350 Grimeca Calipers | 90-91 | FA132            | FA132R                             | MD6034D               |                         |  | FA132               | FA132R                             | N/A     |                               |  |
| EXC 350 Brembo Calipers          | 89    | FA67TT           | FA67R                              | MD6034D               |                         |  | FA67                | FA67R                              | MD6227D |                               |  |
| EXC 350 Grimeca Calipers         | 89    | FA132            | FA132R                             | MD6034D               |                         |  | FA132               | FA132R                             | MD6227D |                               |  |
| EXC 350 LC4 (Standard forks)     | 94-95 | FA181TT          | FA181R                             | MD6032D               |                         | MD6032C  | FA208TT             | FA208R                             | MD6035D | MD6035C                       |  |
| MX/MXC/GS 350                    | 86    | FA47TT           | FA47R                              | N/A                   |                         |  | FA47                | FA47R                              | MD6227D |                               |  |
| MX/EXC 350                       | 87    | FA126TT          | FA126R                             | N/A                   |                         |  | FA126TT             | FA126R                             | N/A     |                               |  |
| MX/EXC/EGS 350                   | 88    | FA132            | FA132R                             | N/A                   |                         |  | FA132               | FA132R                             | MD6227D |                               |  |
| MX 350 Brembo Calipers           | 90-91 | FA67TT           | FA67R                              | N/A                   |                         |  | FA67TT              | FA67R                              | N/A     |                               |  |
| MX 350 Grimeca Calipers          | 90-91 | FA132            | FA132R                             | N/A                   |                         |  | FA132               | FA132R                             | N/A     |                               |  |
| MX 350 Brembo Calipers           | 89    | FA67TT           | FA67R                              | N/A                   |                         |  | FA67TT              | FA67R                              | MD6227D |                               |  |
| MX 350 Grimeca Calipers          | 89    | FA132            | FA132R                             | N/A                   |                         |  | FA132               | FA132R                             | MD6227D |                               |  |
| EXC 350 (Standard forks)         | 96-97 | FA181TT          | FA181R                             | MD6032D               |                         | MD6032C  | FA208TT             | FA208R                             | MD6035D | MD6035C                       |  |
| SX 360 (Standard forks)          | 96-97 | FA181TT          | FA181R                             | MD6032D               |                         | MD6032C  | FA208TT             | FA208R                             | MD6035D | MD6035C                       |  |
| EXC 380 (Standard forks)         | 98-99 | FA181TT          | FA181R                             | MD6032D               |                         | MD6032C  | FA208TT             | FA208R                             | MD6035D | MD6035C                       |  |
| EXC 380 (Upside down forks)      | 00-03 | FA181TT          | FA181R                             | MD6032D               |                         | MD6032C  | FA208TT             | FA208R                             | MD6035D | MD6035C                       |  |
| SX 380 (Standard forks)          | 98-99 | FA181TT          | FA181R                             | MD6032D               |                         | MD6032C  | FA208TT             | FA208R                             | MD6035D | MD6035C                       |  |
| SX 380 (Upside down forks)       | 00-03 | FA181TT          | FA181R                             | MD6032D               |                         | MD6032C  | FA208TT             | FA208R                             | MD6035D | MD6035C                       |  |
| Duke 400 LC4                     | 94-98 | FA95             | FA95HH                             | MD6199D               |                         |  | FA208TT             | FA208R                             | N/A     |                               |  |
| EGS 400/EGS-ELSE (LC4 Enduro)    | 96-99 | FA181TT          | FA181R                             | MD6130D               |                         |  | FA208TT             | FA208R                             | MD6035D | MD6035C                       |  |
| EXC/EGS 400 (USD)                | 00-02 | FA181TT          | FA181R                             | MD6032D               |                         | MD6032C  | FA208TT             | FA208R                             | MD6035D | MD6035C                       |  |
| EXC 400 Racing (USD)             | 00    | FA181TT          | FA181R                             | MD6032D               |                         | MD6032C  | FA208TT             | FA208R                             | MD6035D | MD6035C                       |  |
| EXC 400 Racing                   | 06-07 | FA181TT          | FA181R                             | MD6032D               |                         | MD6032C  | FA368TT             | FA368R                             | MD6035D | MD6035C                       |  |
| LC4-E 400 Enduro                 | 00-01 | FA181TT          | FA181R                             | MD6130D               |                         |  | FA208TT             | FA208R                             | MD6035D | MD6035C                       |  |
| SC 400 (Supercompetition LC4)    | 96-99 | FA181TT          | FA181R                             | MD6032D               |                         | MD6032C  | FA208TT             | FA208R                             | MD6035D | MD6035C                       |  |
| SX 400 (Upside down forks)       | 00-02 | FA181TT          | FA181R                             | MD6032D               |                         | MD6032C  | FA208TT             | FA208R                             | MD6035D | MD6035C                       |  |
| 420 GS                           | 85    |                  | 812WG                              |                       |                         |  |                     | 812WG                              |         |                               |  |
| EXC 440                          | 94-95 | FA181TT          | FA181R                             | MD6032D               |                         | MD6032C  | FA208TT             | FA208R                             | MD6032D | MD6032C                       |  |
| SX 440                           | 94-95 | FA181TT          | FA181R                             | MD6032D               |                         | MD6032C  | FA208TT             | FA208R                             | MD6035D | MD6035C                       |  |
| EXC 450                          | 03    | FA181TT          | FA181R                             | MD6032D               |                         | MD6032C  | FA208TT             | FA208R                             | MD6035D | MD6035C                       |  |
| EXC 450                          | 04-05 | FA181TT          | FA181R                             | MD6032D               |                         | MD6032C  | FA368TT             | FA368R                             | MD6035D | MD6035C                       |  |
| EXC 450 Racing                   | 06-07 | FA181TT          | FA181R                             | MD6032D               |                         | MD6032C  | FA368TT             | FA368R                             | MD6035D | MD6035C                       |  |
| SMR 450                          | 04    |                  | MXS406                             | TBA                   |                         |  | FA368TT             | FA368R                             | MD6035D | MD6035C                       |  |
| SMR 450                          | 05-06 |                  | MXS405                             | MD6270D               |                         | MD6270C  | FA368TT             | FA368R                             | MD6035D | MD6035C                       |  |
| SMR 450                          | 07    |                  | FA433/4HH                          | TBA                   |                         |  | FA368TT             | FA368R                             | MD6035D | MD6035C                       |  |
| SX-F 450 (USD)                   | 03-07 | FA181TT          | FA181R                             | MD6032D               |                         | MD6032C  | FA368TT             | FA368R                             | MD6035D | MD6035C                       |  |
| 495                              | -82   |                  | 812WG                              |                       |                         |  |                     | 813WG                              |         |                               |  |
| 495 MX Leleu                     | 82    |                  | 811WG                              |                       |                         |  |                     | 813WG                              |         |                               |  |
| LC-4 MX/EXC 500                  | 89    | FA132            | FA132R                             | MD6034D               |                         |  | FA132               | FA132R                             | N/A     |                               |  |
| LC-4 MX 500 Brembo Calipers      | 90-91 | FA67TT           | FA67R                              | N/A                   |                         |  | FA67TT              | FA67R                              | MD6035D | MD6035C                       |  |
| LC-4 EXC 500 Brembo Calipers     | 90-91 | FA67TT           | FA67R                              | MD6034D               |                         |  | FA67TT              | FA67R                              | MD6035D | MD6035C                       |  |
| LC-4 MX 500 Grimeca Calipers     | 90-91 | FA132            | FA132R                             | N/A                   |                         |  | FA132               | FA132R                             | MD6035D | MD6035C                       |  |

\*-2 Sets Required. ■ - Also available in MX-S race compound, see page 8. ✖ - Oversize and Supermoto disc available - see page 301.

**SAFETY WARNING-** DO NOT USE HH PADS ON REAR UNLESS ALSO USED ON FRONT TO AVOID BRAKE IMBALANCE.

R Suffix = High Durability Sintered Pad. HH Suffix = High Performance Sintered Pad. G Suffix = Grooved Shoe.

D Suffix = Drilled Disc. C Suffix = Contoured Disc. LS Suffix = Left/Steel Disc. RS = Right/Steel Disc.

BRAKE  
APPLICATIONS

# Non-Japanese Built Motorcycles/Quads



KTM contd.

|                               |              | Front/Avant/Vorn                   |                   |                     | Frente/Anteriore                                     |                                    | Rear/Arrière/Hinten                |                               |                | Posterior/Posteriore |  |
|-------------------------------|--------------|------------------------------------|-------------------|---------------------|--|------------------------------------|------------------------------------|-------------------------------|----------------|----------------------|--|
|                               |              | 1                                  | 2                 | 3                   | 4  | 5                                  | 6                                  | 7                             | 8              | 9                    |  |
|                               |              | Sintered/HH Pads/<br>Grooved shoes | Left/Gauche/Links | Right/Droite/Rechts | Contour Rotor<br>Universal left and<br>right fitment | Sintered/HH Pads/<br>Grooved shoes | Sintered/HH Pads/<br>Grooved shoes | Contour Rotor<br>Rear fitment |                |                      |  |
| LC-4 EXC 500 Grimeca Calipers | 90-91        | FA132                              | FA132R            | MD6034D             |  |                                    | FA132                              | FA132R                        | MD6035D        | MD6035C              |  |
| MX/MXC/XC-GS 500              | 85           | FA47TT                             |                   | N/A                 |  |                                    |                                    | 814G                          |                |                      |  |
| MX 500                        | 92-94        | FA181TT                            | FA181R            | N/A                 |  |                                    | FA67TT                             | FA67R                         | N/A            |                      |  |
| MX 500                        | 95           | FA181TT                            | FA181R            | N/A                 |  |                                    | FA208TT                            | FA208R                        | N/A            |                      |  |
| <b>SX-F 505</b>               | <b>07</b>    | <b>FA181TT</b>                     | <b>FA181R</b>     | <b>MD6032DX</b>     |  | <b>MD6032C</b>                     | <b>FA368TT</b>                     | <b>FA368R</b>                 | <b>MD6035D</b> | <b>MD6035C</b>       |  |
| EXC 520                       | 01-03        | FA181TT                            | FA181R            | MD6032DX            |  | MD6032C                            | FA208TT                            | FA208R                        | MD6035D        | MD6035C              |  |
| SX 520                        | 01-03        | FA181TT                            | FA181R            | MD6032DX            |  | MD6032C                            | FA208TT                            | FA208R                        | MD6035D        | MD6035C              |  |
| EXC 525                       | 03           | FA181TT                            | FA181R            | MD6032DX            |  | MD6032C                            | FA208TT                            | FA208R                        | MD6035D        | MD6035C              |  |
| EXC 525                       | 04-05        | FA181TT                            | FA181R            | MD6032DX            |  | MD6032C                            | FA368TT                            | FA368R                        | MD6035D        | MD6035C              |  |
| EXC 525 Racing                | 06           | FA181TT                            | FA181R            | MD6032DX            |  | MD6032C                            | FA368TT                            | FA368R                        | MD6035D        | MD6035C              |  |
| MXC 525 (Desert Racing)       | 03           | FA181TT                            | FA181R            | MD6032DX            |  | MD6032C                            | FA208TT                            | FA208R                        | MD6035D        | MD6035C              |  |
| MXC 525 (Desert Racing)       | 04           | FA181TT                            | FA181R            | MD6032DX            |  | MD6032C                            | FA208TT                            | FA208R                        | MD6035D        | MD6035C              |  |
| SMR 525                       | 04           |                                    | MXS406            | TBA                 |  |                                    | FA368TT                            | FA368R                        | TBA            |                      |  |
| SMR 525                       | 05           |                                    | MXS405            | MD6270D             |  | MD6270C                            | FA368TT                            | FA368R                        | MD6035D        | MD6035C              |  |
| SX 525                        | 03-06        | FA181TT                            | FA181R            | MD6032DX            |  | MD6032C                            | FA368TT                            | FA368R                        | MD6035D        | MD6035C              |  |
| XC 525 Racing                 | <b>06-07</b> | FA181TT                            | FA181R            | MD6032DX            |  | MD6032C                            | FA368TT                            | FA368R                        | MD6035D        | MD6035C              |  |
| MXC 550                       | 96           | FA181TT                            | FA181R            | MD6032DX            |  | MD6032C                            | FA208TT                            | FA208R                        | MD6035D        | MD6035C              |  |
| SMR 560 Supermoto             | 06           |                                    | MXS405            | N/A                 |  |                                    | FA368TT                            | FA368R                        | MD6035D        | MD6035C              |  |
| <b>SMR 560</b>                | <b>07</b>    |                                    | <b>FA433/4HH</b>  | <b>TBA</b>          |  |                                    | <b>FA368TT</b>                     | <b>FA368R</b>                 | <b>MD6035D</b> | <b>MD6035C</b>       |  |
| LC4 MX/EXC 600                | 89           | FA132                              | FA132R            | MD6034D             |  |                                    | FA132                              | FA132R                        | N/A            |                      |  |
| LC4 MX 600 Brembo Calipers    | 90-91        | FA67TT                             | FA67R             | N/A                 |  |                                    | FA67TT                             | FA67R                         | MD6035D        | MD6035C              |  |
| LC4 EXC 600 Brembo Calipers   | 90-91        | FA67TT                             | FA67R             | MD6034D             |  |                                    | FA67TT                             | FA67R                         | MD6035D        | MD6035C              |  |
| LC4 MX 600 Grimeca Calipers   | 90-91        | FA132                              | FA132R            | N/A                 |  |                                    | FA132                              | FA132R                        | MD6035D        | MD6035C              |  |
| LC4 EXC 600 Grimeca Calipers  | 90-91        | FA132                              | FA132R            | MD6034D             |  |                                    | FA132                              | FA132R                        | MD6035D        | MD6035C              |  |
| LC4 EXC 600                   | 92-93        | FA132                              | FA132R            | MD6034D             |  |                                    | FA67TT                             | FA67R                         | MD6035D        | MD6035C              |  |
| Duke 620 LC4                  | 94-98        | FA95                               | FA95HH            | MD6199D             |  |                                    | FA208TT                            | FA208R                        | N/A            |                      |  |
| EGS 620 Enduro/EGS-E/LS       | 96-99        | FA181TT                            | FA181R            | MD6130D ●           |  |                                    | FA208TT                            | FA208R                        | MD6035D        | MD6035C              |  |
| EGS-E 620 Adventure/Rallye    | 99           | FA181TT                            | FA181R            | MD6032DX            |  | MD6032C                            | FA208TT                            | FA208R                        | MD6035D        | MD6035C              |  |
| LC4 620 SC Supermoto          | 00           | FA181TT                            | FA181R            | MD6199D             |  |                                    | FA208TT                            | FA208R                        | MD6035D        | MD6035C              |  |
| SC 620 Supercompetition       | 96-00        | FA181TT                            | FA181R            | MD6032DX            |  | MD6032C                            | FA208TT                            | FA208R                        | MD6035D        | MD6035C              |  |
| SX 620/EXC/EGS                | 94           | FA181TT                            | FA181R            | MD6032DX            |  | MD6032C                            | FA67TT                             | FA67R                         | N/A            |                      |  |
| SX EXC/EGS 620                | 95           | FA181TT                            | FA181R            | MD6032DX            |  | MD6032C                            | FA208TT                            | FA208R                        | MD6035D        | MD6035C              |  |
| SX 620                        | 96-99        | FA181TT                            | FA181R            | MD6032DX            |  | MD6032C                            | FA208TT                            | FA208R                        | MD6035D        | MD6035C              |  |
| LC4 625 SC Supermoto          | 02           | FA181TT                            | FA181R            | MD6199D             |  |                                    | FA208TT                            | FA208R                        | MD6035D        | MD6035C              |  |
| LC4 625 SC Supercompetition   | 02           | FA181TT                            | FA181R            | MD6032DX            |  | MD6032C                            | FA208TT                            | FA208R                        | MD6035D        | MD6035C              |  |
| SMC 625                       | 05           | FA244                              | FA244HH           |                     |  | <b>MD6199C</b>                     | FA208TT                            | FA208R                        |                | <b>MD6035C</b>       |  |
| SXC 625                       | 03-04        | FA181TT                            | FA181R            | MD6032DX            |  | MD6032C                            | FA208TT                            | FA208R                        | MD6035D        | MD6035C              |  |
| SXC 625                       | 05-06        | FA181TT                            | FA181R            | MD6032DX            |  | MD6032C                            | FA368TT                            | FA368R                        | MD6032D        | MD6032C              |  |
| Duke II 640 (All models)      | 01-06        | FA244                              | FA244HH           | MD6199D             |  |                                    | FA208TT                            | FA208R                        | MD6035D        | MD6035C              |  |
| LC4-E 640 Enduro              | 00-04        | FA181TT                            | FA181R            | MD6130D ●           |  |                                    | FA208TT                            | FA208R                        | MD6035D        | MD6035C              |  |
| LC4-E 640 Supermoto           | 00-06        | FA181TT                            | FA181R            | MD6199D             |  |                                    | FA208TT                            | FA208R                        | MD6035D        | MD6035C              |  |
| LC-4 640 Adventure            | 01-02        | FA181TT                            | FA181R            | MD6199D             |  |                                    | FA208TT                            | FA208R                        | MD6035D        | MD6035C              |  |
| LC-4 640 Adventure            | <b>03-07</b> | <b>FA181TT*</b>                    | <b>FA181R*</b>    | <b>MD6266D</b>      | <b>MD6266D</b>                                       |                                    | FA208TT                            | FA208R                        | MD6035D        | MD6035C              |  |
| LC-R 640 Adventure R          | 00           | FA181TT                            | FA181R            | MD6130D ●           |  |                                    | FA208TT                            | FA208R                        | MD6035D        | MD6035C              |  |
| SMC 640 LC4                   | 05           | FA244                              | FA244HH           | TBA                 |  |                                    | FA208TT                            | FA208R                        | TBA            |                      |  |
| SMC 660 Supermoto             | 03-04        | FA95                               | FA95HH            | TBA                 |  |                                    | FA208TT                            | FA208R                        | MD6035D        | MD6035C              |  |
| SMC 660 Supermoto             | 05-06        | FA244                              | FA244HH           | TBA                 |  |                                    | FA208TT                            | FA208R                        | <b>MD6035D</b> | <b>MD6035C</b>       |  |
| <b>690 Supermoto</b>          | <b>07</b>    | <b>FA244</b>                       | <b>FA244HH</b>    | <b>TBA</b>          |  |                                    | <b>FA208TT</b>                     | <b>FA208R</b>                 | <b>MD681</b>   |                      |  |
| <b>690 SM Prestige</b>        | <b>07</b>    |                                    | <b>FA322/4HH</b>  | <b>MD614LS</b>      |  | <b>MD614C</b>                      | <b>FA208TT</b>                     | <b>FA208R</b>                 | <b>MD681</b>   |                      |  |
| 950 Adventure/S               | 04-06        | FA209/2*                           | FA209/2HH*        | MD6266D             | MD6266D  |                                    | FA181TT                            | FA181R                        | MD6269D        |                      |  |
| 950 R Superenduro             | <b>06-07</b> | <b>FA209/2*</b>                    | <b>FA209/2HH*</b> | <b>MD6299D</b>      |  |                                    | FA181TT                            | FA181R                        | <b>MD6298D</b> |                      |  |
| SMC 950 Supermoto             | 05-06        |                                    | FA322/4HH*        | MD680LS             | MD680RS  |                                    | FA181TT                            | FA181R                        | MD681          |                      |  |
| 990 Adventure/S               | <b>06-07</b> | <b>FA209/2*</b>                    | <b>FA209/2HH*</b> | <b>TBA</b>          | <b>TBA</b>   |                                    | FA181TT                            | FA181R                        | <b>TBA</b>     |                      |  |
| 990 Superduke                 | <b>05-07</b> |                                    | FA322/4HH*        | <b>TBA</b>          | <b>TBA</b>   |                                    | FA208TT                            | FA208R                        | MD681          |                      |  |
| 990 Superduke R               | <b>07</b>    |                                    | <b>FA322/4HH*</b> | <b>TBA</b>          | <b>TBA</b>   |                                    | <b>FA208TT</b>                     | <b>FA208R</b>                 | <b>MD681</b>   |                      |  |

\*-2 Sets Required. ■ - Also available in MX-S race compound, see page 8. ✖ - Oversize and Supermoto disc available - see page 301.

**SAFETY WARNING- DO NOT USE HH PADS ON REAR UNLESS ALSO USED ON FRONT TO AVOID BRAKE IMBALANCE.**

# Non-Japanese Built Motorcycles/Quads



KYMCO

|   |       | Front/Avant/Vorn |         |        | Frente/Anteriore |     | Rear/Arrière/Hinten |       |         | Posterior/Posteriore |  |
|---|-------|------------------|---------|--------|------------------|-----|---------------------|-------|---------|----------------------|--|
|   |       |                  |         |        |                  |     |                     |       |         |                      |  |
|   |       |                  |         |        |                  |     |                     |       |         |                      |  |
| Activ 50  | 05-06 | FA197            | FA197HH |        |                  | N/A |                     | H303  |         |                      |  |
| Agility 50 (KG105A)                             | 05-07 | FA228            | FA228HH | MD971D |                  |     |                     | H303  |         |                      |  |
| Agility 50 Basic                                | 07    | H303             |         |        |                  |     |                     | H303  |         |                      |  |
| Bet & Win 50/Dink Sports 50                     | 02-06 | FA197            | FA197HH |        | MD973D           |     |                     | H303  |         |                      |  |
| Calypso 50/125                                  | 99    | FA235            |         | TBA    |                  |     |                     | H303  |         |                      |  |
| Cobra 50 Cross                                  | 00-06 | FA233            |         | MD971D |                  |     |                     | H303  |         |                      |  |
| Cobra Racer (SF10AG)                            | 00-06 | FA233            |         | MD971D |                  |     |                     | H303  |         |                      |  |
| CX 50 (PR50AE)                                  | 93    | H303             |         |        |                  |     |                     | H333  |         |                      |  |
| CX 50 Super (PR50AC)                            | 94-97 | FA233            |         | MD933D |                  |     |                     | H333  |         |                      |  |
| Dink 50/Spacer 50/Yager 50 (SH10)               | 98-07 | FA197            | FA197HH |        | MD971D           |     |                     | H303  |         |                      |  |
| Dink Classic Euro 2 50 (T8000)                  | 03    | FA197            | FA197HH |        | MD973D           |     |                     | H303  |         |                      |  |
| DJW 50 World (PR50AD)                           | 95-97 | FA235            |         | MD933D |                  |     |                     | H303  |         |                      |  |
| DJX 50 (KA50A)                                  | 91-92 | H303             |         |        |                  |     |                     | H333  |         |                      |  |
| DJY 50 Refined (PR50A)                          | 93-06 | H303             |         |        |                  |     |                     | H333  |         |                      |  |
| Filly 50 (SD10AC)                               | 98-00 | H303             |         |        |                  |     |                     | H303  |         |                      |  |
| Filly LX 50 (S210)                              | 00-06 | FA228            |         | TBA    |                  |     |                     | H303  |         |                      |  |
| Heroism 50 (SE10BA)                             | 95-97 | FA235            |         | MD933D |                  |     |                     | H303  |         |                      |  |
| KB 50 (SE10CA)                                  | 95-00 | FA233            |         | MD933D |                  |     |                     | H303  |         |                      |  |
| K12 Sport 50 (SE10CA)                           | 95-00 | FA233            |         | MD933D |                  |     |                     | H303  |         |                      |  |
| KXR 50 Mongoose                                 | 04-06 | H346*            | H346G*  |        |                  |     |                     | H307  | H307G   |                      |  |
| Looping 50                                      | 98    | FA233            |         | TBA    |                  |     |                     | H303  |         |                      |  |
| Maxxer 50                                       | 05-06 | H346*            | H346G*  |        |                  |     |                     | H307  | H307G   |                      |  |
| MXer 50 (Quad)                                  | 00-07 | H303*            | H303G*  |        |                  |     |                     | FA305 | FA305R  | MD6267D              |  |
| MXU 50  | 05-07 | H303*            | H303G*  |        |                  |     |                     | FA305 | FA305R  | MD6267D              |  |
| People 50 (BA10AD)                              | 99-06 | FA305            |         | MD989D |                  |     |                     | 818   |         |                      |  |
| People S 50 (BA10BA)                            | 05-07 | FA305            |         | MD989D |                  |     |                     | 818   |         |                      |  |
| Sniper 50 (PR50B)                               | 93    | FA233            |         | MD933D |                  |     |                     | H303  |         |                      |  |
| Sniper 50 DD (PR50BB)                           | 94-96 | FA233            |         | MD933D |                  |     |                     | FA234 |         | MD926D               |  |
| Super 9 50 (LC) (SH10DA)                        | 00-07 | FA197            | FA197HH |        | MD981D           |     |                     | FA305 |         | MD971D               |  |
| Super 9 (A/C)                                   | 00-07 | FA197            | FA197HH |        | MD981D           |     |                     | H303  |         |                      |  |
| Yup 50  | 02-07 | FA228            | FA228HH | MD971D |                  |     |                     | H303  |         |                      |  |
| ZX 50 Super Fever/Scout (SC10AS) (ZX12)         | 99-06 | FA233            |         | MD971D |                  |     |                     | H303  |         |                      |  |
| Top Boy 50 (On road & off road models) (SF10GG) | 97-06 | FA233            |         | MD971D |                  |     |                     | H303  |         |                      |  |
| Vitality 50 (2T & 4T)                           | 05-06 | FA228            | FA228HH | MD971D |                  |     |                     | H303  |         |                      |  |
| Vitality Cross (10" wheels)                     | 07    | FA228            | FA228HH | MD971D |                  |     |                     | H303  |         |                      |  |
| Vitality Sports (12" wheels)                    | 07    | FA228            | FA228HH | MD971D |                  |     |                     | H303  |         |                      |  |
| Yager 50  | 07    | FA197            | FA197HH |        | MD971D           |     |                     | H303  |         |                      |  |
| KXR 90 Mongoose Quad                            | 04-06 | H338*            | H338G*  |        |                  |     |                     | TBA   |         |                      |  |
| Maxxer 90                                       | 05-06 | H346*            | H346G*  |        |                  |     |                     | FA305 | FA305R  | MD971D               |  |
| AS 100/125                                      | 99    | TBA              |         |        |                  |     |                     | TBA   |         |                      |  |
| Cobra 100 Racer                                 | 99-03 | FA228            | FA228HH | TBA    |                  |     |                     | H303  |         |                      |  |
| KB 100 Manboy                                   | 97-00 | FA233            |         | MD933D |                  |     |                     | H303  |         |                      |  |
| Spike 100/125                                   | 00-06 | FA86             | FA86HH  |        | N/A              |     |                     | TBA   |         | N/A                  |  |
| Top Boy 100 (On road & off road models)         | 97    | FA233            |         | TBA    |                  |     |                     | H303  |         |                      |  |
| Activ 110/125                                   | 04-06 | FA197            | FA197HH |        | N/A              |     |                     | H303  |         |                      |  |
| Agility 125                                     | 06-07 | FA228            | FA228HH | MD971D |                  |     |                     | H303  |         |                      |  |
| Bet & Win 125/150 (SH25CA/30C)                  | 00-06 | FA197            | FA197HH |        | MD973D           |     |                     | FA197 | FA197HH | MD974D               |  |
| Cruiser 125                                     | 99    | FA197            | FA197HH |        | TBA              |     |                     | TBA   |         |                      |  |
| Dink Classic 125/150 (SH25BB/30B)               | 02    | FA197            | FA197HH |        | MD973D           |     |                     | FA197 | FA197HH | MD971D               |  |
| Dink/Spacer 125/150 (SH25/30)                   | 97-04 | FA197            | FA197HH |        | MD971D           |     |                     | FA197 | FA197HH | MD971D               |  |
| Dink LX 125/150 (SH25BA/30B)                    | 98-00 | FA197            | FA197HH | MD971D |                  |     |                     | FA197 | FA197HH | MD971D               |  |
| Grand Dink/Miller 125/150 (S40000-00)           | 01-07 | FA197            | FA197HH |        | MD973D           |     |                     | FA197 | FA197HH | MD974D               |  |
| Grand King 125/150                              | 99-06 | TBA              |         |        |                  |     |                     | TBA   |         |                      |  |
| Heroism 125 (SE25BA)                            | 95-97 | FA235            |         | MD933D |                  |     |                     | H303  |         |                      |  |
| Heroism 150 (SE30AD)                            | 95-97 | FA235            |         | MD933D |                  |     |                     | FA234 |         | MD926D               |  |
| Hipster 125/150                                 | 99-06 | FA197            | FA197HH |        | N/A              |     |                     | H340  |         |                      |  |
| Movie 125 (SL25AA)                              | 99-00 | FA228            | FA228HH | MD972D |                  |     |                     | 818   |         |                      |  |
| Movie XL 125/150 (S510/500)                     | 01-06 | FA197            | FA197HH |        | MD972D           |     |                     | 818   |         |                      |  |
| MXer 125/150 Quad (LA35AD/LA30AD)               | 02-07 | H303*            | H303G*  |        |                  |     |                     | FA305 | FA305R  | MD6267D              |  |
| People 125/150 (RFBB02)                         | 99-06 | FA305            |         | MD989D |                  |     |                     | 818   |         |                      |  |

\*-2 Sets Required. ■ - Also available in MX-S race compound, see page 8. ✖ - Oversize and Supermoto disc available - see page 301.

**SAFETY WARNING-** DO NOT USE HH PADS ON REAR UNLESS ALSO USED ON FRONT TO AVOID BRAKE IMBALANCE.

R Suffix = High Durability Sintered Pad. HH Suffix = High Performance Sintered Pad. G Suffix = Grooved Shoe.  
D Suffix = Drilled Disc. C Suffix = Contoured Disc. LS Suffix = Left/Steel Disc. RS = Right/Steel Disc.

BRAKE APPLICATIONS

# Non-Japanese Built Motorcycles/Quads



APPLICATIONS  
BRAKE

R Suffix = High Durability Sintered Pad. HH Suffix = High Performance Sintered Pad. G Suffix = Grooved Shoe.

D Suffix = Drilled Disc. C Suffix = Contoured Disc. LS Suffix = Left/Steel Disc. RS = Right/Steel Disc.

## KYMCO contd.

|                                       |               | Front/Avant/Vorn                   |                   |                     | Frente/Anteriore                                     |                                    | Rear/Arrière/Hinten                |                               |         | Posterior/Posteriore |  |
|---------------------------------------|---------------|------------------------------------|-------------------|---------------------|--|------------------------------------|------------------------------------|-------------------------------|---------|----------------------|--|
|                                       |               | 1                                  | 2                 | 3                   | 4  | 5                                  | 6                                  | 7                             | 8       | 9                    |  |
|                                       |               | Sintered/HH Pads/<br>Grooved shoes | Left/Gauche/Links | Right/Droite/Rechts | Contour Rotor<br>Universal left and<br>right fitment | Sintered/HH Pads/<br>Grooved shoes | Sintered/HH Pads/<br>Grooved shoes | Contour Rotor<br>Rear fitment |         |                      |  |
| People S 125/200 (BA40BA)             | 05-07         | FA305                              |                   | MD989D              |  |                                    | 818                                |                               |         |                      |  |
| Pulsar 125/CK 125 (Luxe) (RJ25CB)     | 99-06         | FA86                               | FA86HH            |                     | N/A  |                                    | H340                               |                               |         |                      |  |
| Quannon 125                           | 07            | FA197                              | FA197HH           |                     | N/A  |                                    | FA197                              | FA197HH                       | N/A     |                      |  |
| Sector 125                            | 98-01         | FA197                              | FA197HH           |                     | N/A  |                                    | TBA                                |                               |         |                      |  |
| Spike 125 R                           | 04-06         | FA197                              | FA197HH           | N/A                 |  |                                    | FA197                              | FA197HH                       | MD6267D |                      |  |
| Straight 125                          | 05-06         | FA197                              | FA197HH           | N/A                 |  |                                    | N/A                                |                               |         |                      |  |
| Stryker 125 (DA25BB) On Road/Off Road | 01-06         | FA228                              | FA228HH           | N/A                 |  |                                    | H340                               |                               |         |                      |  |
| Yager GT 125                          | 07            | FA197                              | FA197HH           |                     | TBA  |                                    | FA197                              | FA197HH                       | MD974D  |                      |  |
| MXU 150                               | 05-06         | 303*                               | 303G*             |                     |  |                                    | FA305                              | FA305R                        | TBA     |                      |  |
| Stryker 150 (Off road)                | 00-06         | FA228                              | FA228HH           | N/A                 |  |                                    | H340                               |                               |         |                      |  |
| Vivio 125/150 (SL25BA/30AC)           | 00-03         | FA228                              | FA228HH           |                     | MD972D   |                                    | 818                                |                               |         |                      |  |
| Yager 125                             | 00            | FA197                              | FA197HH           |                     | MD971D   |                                    | FA197                              | FA197HH                       | MD971D  |                      |  |
| Zing 125/150 Custom Style (RF25/30)   | 97-06         | FA197                              | FA197HH           |                     | N/A  |                                    | H340                               |                               |         |                      |  |
| Bet & Win 250 (S7000)                 | 00-06         | FA197                              | FA197HH           |                     | MD973D   |                                    | FA197                              | FA197HH                       | MD974D  |                      |  |
| Grand Dink 250 (S400)                 | 01-06         | FA355*                             |                   |                     | MD973D   |                                    | FA356                              |                               | MD974D  |                      |  |
| KXR 250 Mongoose Quad                 | 04-07         | FA377*                             | FA377R*           | MD6267D             | MD6267D  |                                    | FA355*                             | FA355R*                       | MD6268D |                      |  |
| MXU 250                               | 04-07         | FA377*                             | FA377R*           | MD6267D             | MD6267D  |                                    | FA355*                             | FA355R*                       | MD6268D |                      |  |
| People 250 (BC50AA)                   | 03-06         | FA197                              | FA197HH           |                     | MD9100D  |                                    | FA197                              | FA197HH                       | MD9100D |                      |  |
| People 250                            | Left<br>Right | 06<br>06                           | FA228<br>FA197HH  | TBA                 |  |                                    | FA196                              |                               | MD971D  |                      |  |
| Urban Quad 250                        | 06            | FA377*                             | FA377R*           | TBA                 | TBA  |                                    | FA355                              | FA355R                        | TBA     |                      |  |
| Venox 250 (Custom) (RA50AA)           | 00-06         | FA196                              | FA196HH           | MD1101              |  |                                    | H321                               |                               |         |                      |  |
| Xciting 250/250i                      | 05-07         | FA142*                             | FA142HH*          | N/A                 | N/A  |                                    | FA196                              | FA196HH                       | N/A     |                      |  |
| Yup 250 (W2000)                       | 03-06         | FA197                              | FA197HH           |                     | MD973D   |                                    | FA196                              | FA196HH                       | MD974D  |                      |  |
| Maxxer 300                            | 06-07         | FA377*                             | FA377R*           | MD6267D             | MD6267D  |                                    | FA355*                             | FA355R*                       | MD6268D |                      |  |
| MXU 300                               | 06-07         | FA377*                             | FA377R*           | MD6267D             | MD6267D  |                                    | FA377*                             | FA377R*                       | MD6267D |                      |  |
| MXU 500 (4x4)                         | 06-07         | FA377*                             | FA377R*           | TBA                 | TBA  |                                    | FA377*                             | FA377R*                       | TBA     |                      |  |
| Xciting 500/500i                      | 04-07         | FA142*                             | FA142HH*          | TBA                 | TBA  |                                    | FA196                              | FA196HH                       | TBA     |                      |  |

## LAMBRETTA

|                 |  |       |  |     |  |  |     |  |  |  |
|-----------------|--|-------|--|-----|--|--|-----|--|--|--|
| All Disc Models |  | FA100 |  | N/A |  |  | 958 |  |  |  |
| 125/150/175 L1  |  | 958   |  |     |  |  | 958 |  |  |  |
| 125/150/200 DL  |  | 959   |  |     |  |  | 959 |  |  |  |
| 125/150 D-LD    |  | N/A   |  |     |  |  | 957 |  |  |  |

## LAVERDA

|                                   |       |          |         |          |          |          |         |        |         |         |
|-----------------------------------|-------|----------|---------|----------|----------|----------|---------|--------|---------|---------|
| CR 50 Atlas                       | 87-   | FA47     | FA47HH  | N/A      |          |          | FA47    | FA47HH | N/A     |         |
| Quasar 50                         | 02-04 | H338*    | H338G*  |          |          |          | H330    | H330G  |         |         |
| Quasar 100                        | 02-04 | H338*    | H338G*  |          |          |          | H330    | H330G  |         |         |
| Mini Quasar                       | 02-04 | TBA*     |         |          |          |          | TBA     |        |         |         |
| GS 125 Lesmo                      | 86-89 | FA47*    | FA47HH* | N/A      | N/A      |          |         |        |         |         |
| LB 125 Custom/Sabbia Strada/Sport | 85-87 | FA60     |         | N/A      |          |          | 921     |        |         |         |
| LZ 125 Sport Brembo Caliper       | 80-82 | FA47     | FA47HH  | N/A      |          |          | 921     |        |         |         |
| LZ 125 Sport Grimeca Caliper      | 80-82 | FA74     |         | N/A      |          |          | 921     |        |         |         |
| Phoenix 125/150/200               | 01-04 | FA306    |         | N/A      |          |          | FA305   |        | TBA     |         |
| Quasar 125 HP Grip                | 02-04 | TBA*     |         |          |          |          | TBA     |        |         |         |
| Quasar 125 HP                     | 02-04 | TBA*     |         |          |          |          | TBA     |        |         |         |
| Quasar 180 HP Grip                | 04    | TBA*     |         |          |          |          | TBA     |        |         |         |
| Quasar 180 HP                     | 04    | TBA*     |         |          |          |          | TBA     |        |         |         |
| Quasar 4x4 400                    | 04    | FA271TT* | FA271R* | MD6173D  | MD6173D  |          | FA271TT | FA271R | MD6173D |         |
| Montjuic                          | 76    | FA47*    | FA47HH* | N/A      | N/A      |          | FA47    | FA47HH | N/A     |         |
| Alpino 500                        | 76    | FA47*    | FA47HH* | N/A      | N/A      |          | FA47    | FA47HH | N/A     |         |
| Quasar 4x4 500C                   | 04    | FA271TT* | FA271R* | MD6173D  | MD6173D  |          | FA271TT | FA271R | MD6173D |         |
| Quasar 4x4 500                    | 04    | FA271TT* | FA271R* | MD6173D  | MD6173D  |          | FA271TT | FA271R | MD6173D |         |
| 650 All models                    | 94-95 | FA95*    | FA95HH* | MD2003LS | MD2003RS | MD2003C* | FA47    | FA47HH | MD2002  | MD2002C |
| 668 All models                    | 96-98 | FA95*    | FA95HH* | MD2003LS | MD2003RS | MD2003C* | FA47    | FA47HH | MD2002  | MD2002C |
| 750 SF2                           | 74    | FA18*    | FA18HH* | MD609LS  | MD609RS  |          | N/A     |        |         |         |
| 750 SFC                           | 74    | FA18*    | FA18HH* | MD609LS  | MD609RS  |          | FA18    | FA18HH | MD609LS |         |
| 750 SF3                           | 76-77 | FA18*    | FA18HH* | MD609LS  | MD609RS  |          | FA18    | FA18HH | MD609LS |         |
| 750 All models                    | 98-01 | FA95*    | FA95HH* | MD2003LS | MD2003RS | MD2003C* | FA47    | FA47HH | MD2002  | MD2002C |

\*-2 Sets Required. ■ - Also available in MX-S race compound, see page 8. ✖ - Oversize and Supermoto disc available - see page 301.

**SAFETY WARNING-** DO NOT USE HH PADS ON REAR UNLESS ALSO USED ON FRONT TO AVOID BRAKE IMBALANCE.



# Non-Japanese Built Motorcycles/Quads



## LAVERDA contd.

|   |       | Front/Avant/Vorn                   |                   |                     | Frente/Anteriore                                     |         | Rear/Arrière/Hinten                |         |                               | Posterior/Posteriore |  |
|---|-------|------------------------------------|-------------------|---------------------|--|---------|------------------------------------|---------|-------------------------------|----------------------|--|
|   |       | 1                                  | 2                 | 3                   | 4  | 5       | 6                                  | 7       | 8                             | 9                    |  |
|   |       | Sintered/HH Pads/<br>Grooved shoes | Left/Gauche/Links | Right/Droite/Rechts | Contour Rotor<br>Universal left and<br>right fitment |         | Sintered/HH Pads/<br>Grooved shoes |         | Contour Rotor<br>Rear fitment |                      |  |
| 1000 3C                                   | 74-75 | FA18*                              | FA18HH*           | MD609LS             | MD609RS  |         | FA18                               | FA18HH  | MD609LS                       |                      |  |
| 1000 3CL                                  | 76-78 | FA18*                              | FA18HH*           | MD609LS             | MD609RS  |         | FA18                               | FA18HH  | MD609LS                       |                      |  |
| 1000 3CL Jarama/Jota                      | 79-81 | FA18*                              | FA18HH*           | MD609LS             | MD609RS  |         | FA18                               | FA18HH  | MD609LS                       |                      |  |
| 1000 RGS                                  | 82    | FA18*                              | FA18HH*           | MD609LS             | MD609RS  |         | FA18                               | FA18HH  | MD609LS                       |                      |  |
| 1000 RGA/RGS Exec                         | 83    | FA18*                              | FA18HH*           | MD609LS             | MD609RS  |         | FA18                               | FA18HH  | MD609LS                       |                      |  |
| 1000 RGS Corsa                            | 84    | FA77*                              |                   | MD609ALS            | MD609ARS   |         | FA18                               |         | MD609ALS                      |                      |  |
| 1000 SFC                                  | 85-86 | FA18*                              | FA18HH*           | MD668LS             | MD668RS  |         | FA18                               | FA18HH  | MD609LS                       |                      |  |
| SFC 1000                                  | 03-04 |                                    | FA322/4HH*        | MD621LS             | MD621RS  | MD621C* | FA266                              | FA266HH | MD613                         | MD613C               |  |
| 1200                                      | 78-79 |                                    |                   | MD609LS             | MD609RS  |         |                                    |         | MD609LS                       |                      |  |
| 1200 TS/Mirage                            | 81    |                                    |                   | MD609LS             | MD609RS  |         |                                    |         | MD609LS                       |                      |  |
| MD670 - Bolt on - Ring only               |       |                                    |                   |                     |  |         |                                    |         |                               |                      |  |
| Note: Disc ring only for early 280mm disc |       |                                    |                   |                     |  |         |                                    |         |                               |                      |  |
| 9 bolt fixing @ 6.5mm thickness           |       |                                    |                   |                     |  |         |                                    |         |                               |                      |  |

## LEM

|                          |       |  |        |     |  |  |  |        |  |     |
|--------------------------|-------|--|--------|-----|--|--|--|--------|--|-----|
| R2/R3 (Hydraulic System) | 03-05 |  | FA325R | N/A |  |  |  | FA325R |  | N/A |
|--------------------------|-------|--|--------|-----|--|--|--|--------|--|-----|

## LIFAN

|  |  |            |         |  |     |  |            |  |  |  |
|--|--|------------|---------|--|-----|--|------------|--|--|--|
| LF 50 QGY  |  | FA169      | FA169HH |  |     |  | H303/H304† |  |  |  |
| LF 50 QGY 1/2  |  | H303/H304† |         |  |     |  | H303/H304† |  |  |  |
| Smart 50/125   |  | FA375      |         |  |     |  | H304       |  |  |  |
| LF-100 5   |  | S603       |         |  |     |  | S603       |  |  |  |
| LF 100 A   |  | FA86       | FA86HH  |  |     |  | H304       |  |  |  |
| LT-125 T-2D  |  | TBA        |         |  |     |  | TBA        |  |  |  |
| LT-125-3A  |  | FA56       |         |  | N/A |  | S602       |  |  |  |
| †Check old shoe against drawings in buyers guide to select correct shoe. |  |            |         |  |     |  |            |  |  |  |

## LML

|                           |  |       |         |        |  |  |      |  |  |  |
|---------------------------|--|-------|---------|--------|--|--|------|--|--|--|
| Star 125 DLX (Drum model) |  | V903  |         |        |  |  | V903 |  |  |  |
| Star 125 DLX (Disc model) |  | FA260 | FA260HH | MD910D |  |  | V903 |  |  |  |

## MAGNI

|              |    |        |          |     |     |  |      |        |     |  |
|--------------|----|--------|----------|-----|-----|--|------|--------|-----|--|
| Sport 1200 S | 01 | FA244* | FA244HH* | N/A | N/A |  | FA63 | FA63HH | N/A |  |
|--------------|----|--------|----------|-----|-----|--|------|--------|-----|--|

## MAICO

|               |       |         |         |     |     |  |         |         |     |  |
|---------------|-------|---------|---------|-----|-----|--|---------|---------|-----|--|
| All models    | -84   |         | 821G    |     |     |  |         | 822G    |     |  |
| All models    | 85    | FA47    | FA47R   | N/A |     |  |         | 822G    |     |  |
| All models    | 86-88 | FA106TT | FA106R  | N/A |     |  | FA106TT | FA106R  | N/A |  |
| All models    | 89-93 | FA132   | FA132R  | N/A |     |  | FA132   | FA132R  | N/A |  |
| 250 MX        | 94-98 | FA132   | FA132R  | N/A |     |  | FA132   | FA132R  | N/A |  |
| 500 MX        | 94-98 | FA132   | FA132R  | N/A |     |  | FA67    | FA67R   | N/A |  |
| 500 MX/Enduro | 99    | FA181TT | FA181R■ |     | N/A |  | FA208TT | FA208R■ | N/A |  |

## MALAGUTI

|                       |       |        |       |     |  |  |      |       |     |  |
|-----------------------|-------|--------|-------|-----|--|--|------|-------|-----|--|
| Chopper 25/40         | -82   | FA50   |       | N/A |  |  | 908  |       |     |  |
| 50 LX Sport           | -82   | FA50   |       | N/A |  |  | 908  |       |     |  |
| 50 Ronco RCW          | -82   | FA50   |       | N/A |  |  | 908  |       |     |  |
| 50 Fifty HF           | -82   | FA50   |       | N/A |  |  |      | 926WG |     |  |
| VA Olympique          | -82   | FA50   |       | N/A |  |  | 908  |       |     |  |
| 50 Watercooled        | -82   | FA50   |       | N/A |  |  |      | 926WG |     |  |
| 50 Enduro RCX-W/Sahib | 83-   | FA99   |       | N/A |  |  |      | 930WG |     |  |
| 50 Fifty Full/CX      | 83-   | FA99   |       | N/A |  |  |      | 926WG |     |  |
| 50 RGT Strada         | 83-   | FA99   |       | N/A |  |  | 931  |       |     |  |
| 50 Enduro Dune        | 87-   | FA99   |       | N/A |  |  | FA99 |       | N/A |  |
| 50 MDX Gold Enduro    | 87-   | FA67/2 |       | N/A |  |  |      | 922WG |     |  |
| 50 Enduro MEX         | 85-86 | FA47   | FA47R | N/A |  |  |      | 922WG |     |  |
| 50 Enduro MEX         | 87-   | FA67/2 |       | N/A |  |  |      | 922WG |     |  |
| 50 Enduro MGX         | 87-   |        | 922WG |     |  |  |      | 922WG |     |  |
| 50 Enduro MLX         | 87-   | FA116  |       | N/A |  |  |      | 922WG |     |  |

\*-2 Sets Required. ■ - Also available in MX-S race compound, see page 8. ✖ - Oversize and Supermoto disc available - see page 301.

**SAFETY WARNING-** DO NOT USE HH PADS ON REAR UNLESS ALSO USED ON FRONT TO AVOID BRAKE IMBALANCE.

**R** Suffix = High Durability Sintered Pad. **HH** Suffix = High Performance Sintered Pad. **G** Suffix = Grooved Shoe.  
**D** Suffix = Drilled Disc. **C** Suffix = Contoured Disc. **LS** Suffix = Left/Steel Disc. **RS** = Right/Steel Disc.

**BRAKE  
APPLICATIONS**

# Non-Japanese Built Motorcycles/Quads



## MALAGUTI contd.

|  |       | Front/Avant/Vorn |          |         | Frente/Anteriore |  | Rear/Arrière/Hinten |         |        | Posterior/Posteriore |  |
|--|-------|------------------|----------|---------|------------------|--|---------------------|---------|--------|----------------------|--|
|  |       |                  |          |         |                  |  |                     |         |        |                      |  |
|  |       |                  |          |         |                  |  |                     |         |        |                      |  |
| 50 Enduro MSX                          | 85-   | FA67/2           |          | N/A     |                  |  |                     | 922WG   |        |                      |  |
| 50 Fifty Top                           | 85-   | FA99             |          | N/A     |                  |  | 926                 |         |        |                      |  |
| 50 RGT Sport                           | 85-   | FA99             |          | N/A     |                  |  |                     | 922WG   |        |                      |  |
| 50 Custom Fox                          | 87-   | 931              |          |         |                  |  | 931                 |         |        |                      |  |
| 50 Dribbling                           | 87-   | 931              |          |         |                  |  | 931                 |         |        |                      |  |
| 50 Fifty HF/NL 4 gears                 | 87-   |                  | 922WG    |         |                  |  |                     | 922WG   |        |                      |  |
| 50 Fifty RV                            | 87-   | 931              |          |         |                  |  | 931                 |         |        |                      |  |
| 50 Grizzly RCX 4/RCX 12                | 87-   | 931              |          |         |                  |  | 931                 |         |        |                      |  |
| 50 Grizzly RCX 10                      | 87-   | FA50             |          | N/A     |                  |  | 931                 |         |        |                      |  |
| 50 Ranocchio 3 Wheels                  | 87-   | 931              |          |         |                  |  | 931                 |         |        |                      |  |
| 50 RST Sport                           | 87-   | FA99             |          | N/A     |                  |  | FA99                |         | N/A    |                      |  |
| 50 MXR                                 | 89-   | FA60             |          | N/A     |                  |  |                     |         |        |                      |  |
| 50 America                             | 91-   | FA173            |          | N/A     |                  |  | 893                 |         |        |                      |  |
| 50 Evolution                           | 91-   | FA99             |          | N/A     |                  |  | N/A                 |         |        |                      |  |
| 50 Raid                                | 91-   | FA99             |          | N/A     |                  |  | 893                 |         |        |                      |  |
| Centro SL/SL Cat 50                    | 94-00 | FA116            |          |         | MD902D           |  | 893                 |         |        |                      |  |
| Centro Base 50 (Drum front model)      | 93-94 |                  | 926WG    |         |                  |  | 893                 |         |        |                      |  |
| Centro Base (Front disc model)         |       | FA116            |          |         | MD902D           |  | 893                 |         |        |                      |  |
| Ciak 50                                | 00-04 | FA193            | FA193HH  |         | MD955D           |  | 893                 |         |        |                      |  |
| Ciak 50 Twin Disc                      | 00-03 | FA193            | FA193HH  | MD955D  |                  |  | FA193               | FA193HH | MD901D |                      |  |
| Ciak 50 (4T) Master                    | 04-07 | FA193            | FA193HH  | MD955D  |                  |  | 816                 |         |        |                      |  |
| Drakon S                               | 06    | FA266            | FA266HH  |         | N/A              |  | FA115               | FA115HH | N/A    |                      |  |
| F10 Jetline 50                         | 91-93 | FA173            |          | MD915D  |                  |  | 893                 |         |        |                      |  |
| F10 Jet Line 50/Jet Line WAP           | 94-07 | FA193            | FA193HH  | MD915D  |                  |  | 893                 |         |        |                      |  |
| Phantom F12 ***                        | 94-98 | FA99             |          | MD901D  |                  |  | 893                 |         |        |                      |  |
| F12 Phantom 50 **                      | 94-03 | FA116            |          |         |                  |  | 893                 |         |        |                      |  |
| F12 50 Phantom                         | 98    | FA116            |          | MD901D  |                  |  | FA193               |         |        | MD901D               |  |
| F12 50 Phantom                         | 99-03 | FA116            |          | MD946D  |                  |  | FA193               |         |        | MD901D               |  |
| F12 Phantom (Air cooled) all models    | 02-07 | FA193            | FA193HH  | MD946D  |                  |  | 893                 |         |        |                      |  |
| F12 Phantom All liquid cooled models   | 00-07 | FA193            | FA193HH  | MD946D  |                  |  | FA193               | FA193HH | MD901D |                      |  |
| NKD 50 Drakon                          | 05-07 | FA266            | FA266HH  |         | N/A              |  | FA115               | FA115HH | N/A    |                      |  |
| XSM 50 Super Motard                    | 03-07 | FA194            | FA194HH  | MD6279D |                  |  | FA115               | FA115HH | N/A    |                      |  |
| XTM 50                                 | 03-07 | FA115            | FA115HH  | N/A     |                  |  | FA115               | FA115HH | N/A    |                      |  |
| Chopper 80                             | -82   | FA50             |          |         |                  |  | 908                 |         |        |                      |  |
| Enduro MDX 80                          | 84-   | FA47             | FA47R    |         |                  |  |                     |         |        |                      |  |
| Ciak 100                               | 99-03 | FA193            | FA193HH  | MD955D  |                  |  | FA193               | FA193HH | MD901D |                      |  |
| Phantom 100 F12                        | 99-03 | FA193            | FA193HH  | MD946D  |                  |  | FA193               | FA193HH | MD901D |                      |  |
| Firefox F15 50                         | 96-98 | FA116            |          | MD901D  |                  |  | 893                 |         |        |                      |  |
| F15 50 Firefox                         | 98-00 | FA116            |          | MD901D  |                  |  | FA193               |         |        | MD901D               |  |
| F15 Firefox (All liquid cooled models) | 01-06 | FA193            | FA193HH  | MD946D  |                  |  | FA193               | FA193HH | MD901D |                      |  |
| Firefox F15 (Air cooled models)        | 99-06 | FA193            | FA193HH  | MD946D  |                  |  | 893                 |         |        |                      |  |
| F69 Phantom 70cc                       | 98    | FA193            | FA193HH  | MD936D  |                  |  | 893                 |         |        |                      |  |
| Crosser CR1 ***                        | 95-98 | FA99             |          | MD901D  |                  |  | 807                 |         |        |                      |  |
| Crosser CR1                            | 95-98 | FA116            |          | MD901D  |                  |  | 807                 |         |        |                      |  |
| Yesterday                              | 98-03 | FA116            |          | MD915D  |                  |  | 893                 |         |        |                      |  |
| Ciak 125/150                           | 01-07 | FA47             | FA47HH   | MD955D  |                  |  | 818                 |         |        |                      |  |
| Madison T 125/150/180                  | 99-03 | FA194            | FA194HH  | MD966D  |                  |  | FA298               |         |        | MD966D               |  |
| Phantom Max 125/200                    | 04-06 | FA194            | FA194HH  | MD966D  |                  |  | FA298               |         |        | MD966D               |  |
| R 125 Madison                          | 03-07 | FA194            | FA194HH  | MD966D  |                  |  | FA298               |         |        | MD966D               |  |
| Ciak 200                               | 06-07 | FA47             | FA47HH   | MD955D  |                  |  | 818                 |         |        |                      |  |
| Madison S 200                          | 04    | FA194            | FA194HH  | MD966D  |                  |  | FA298               |         |        | MD966D               |  |
| Madison S 250                          | 99-03 | FA324            |          | MD967D  |                  |  | FA298               |         |        | MD966D               |  |
| Password 250                           | 05-07 | FA194            | FA194HH  | TBA     |                  |  | FA298               |         |        | TBA                  |  |
| RS 250 Madison                         | 04-07 | FA194            | FA194HH  | MD966D  |                  |  | FA298               |         |        | MD966D               |  |
| Phantom Max 250                        | 04-07 | FA194            | FA194HH  | MD966D  |                  |  | FA298               |         |        | MD966D               |  |
| F18 Warrior 125/150                    | 00-03 | FA47             | FA47HH   | TBA     |                  |  | FA298               |         |        | MD946D               |  |
| Madison K 400                          | 02-06 | FA324            |          | MD969D  |                  |  | FA298               |         |        | MD967D               |  |
| Spider Max GT 500                      | 04-07 | FA256*           | FA256HH* | TBA     | TBA              |  | FA298               |         |        | TBA                  |  |
| Grizzly 4 wheels (quad)                | 04-05 | N/A              |          |         |                  |  | TBA                 |         |        |                      |  |
| Ciak (Electric Power)                  | 00-05 | FA193            | FA193HH  | MD946D  |                  |  | TBA                 |         |        |                      |  |

\*-2 Sets Required. ■ - Also available in MX-S race compound, see page 8. ✖ - Oversize and Supermoto disc available - see page 301.

**SAFETY WARNING-** DO NOT USE HH PADS ON REAR UNLESS ALSO USED ON FRONT TO AVOID BRAKE IMBALANCE.

# Non-Japanese Built Motorcycles/Quads



## MALAGUTI contd.

\*\*Note - Pads with one pin hole \*\*\*Note - Pads with two pin holes

## MALANCA

|                      |     | Front/Avant/Vorn |        |     | Frente/Anteriore |   | Rear/Arrière/Hinten |       |     |
|----------------------|-----|------------------|--------|-----|------------------|---|---------------------|-------|-----|
|                      |     | 1                | 2      | 3   | 4                | 5 | 6                   | 7     | 8   |
| E2 C80/CS            |     | FA47*            | FA47R* | N/A | N/A              |   | FA47                | FA47R | N/A |
| 125 GTI              |     | FA47*            | FA47R* | N/A | N/A              |   | FA47                | FA47R | N/A |
| 125 Mark Enduro      | -84 | FA47             | FA47R  | N/A |                  |   | N/A                 |       |     |
| 125/ST 54/GT 5       |     | FA50             |        | N/A |                  |   | N/A                 |       |     |
| 125 ob one M6        | 85- | FA60             |        | N/A |                  |   | FA60                |       | N/A |
| 125 ob one M6 Racing | 85- | FA60*            |        | N/A |                  |   | FA60                |       | N/A |
| 125 Mark Enduro      | 85- | FA60             |        | N/A |                  |   |                     | 841WG |     |

## MASAI

|                   |       |         |        |     |     |  |        |         |     |
|-------------------|-------|---------|--------|-----|-----|--|--------|---------|-----|
| K50               | 05-07 | TBA*    |        |     |     |  | TBA    |         | N/A |
| L50               | 05-07 | TBA*    |        |     |     |  | TBA    |         | N/A |
| L100              | 05-07 | TBA*    |        |     |     |  | TBA    |         | N/A |
| L150              | 05-07 | TBA*    |        |     |     |  | TBA    |         | N/A |
| 110/125 Dirt Bike | 06    | TBA*    |        | N/A |     |  | TBA    |         | N/A |
| A300 Quad         | 05-07 | FA83TT* | FA83R* | N/A | N/A |  | FA355* | FA355R* | N/A |
| A450 Quad         | 05-07 | FA83TT* | FA83R* | N/A | N/A |  | FA355* | FA355R* | N/A |

## MASSEY-FERGUSON (ATV)

|                       |    |          |         |         |         |  |         |        |         |
|-----------------------|----|----------|---------|---------|---------|--|---------|--------|---------|
| MF 250 (2WD/4WD)      | 04 | FA271TT* | FA271R* | MD6173D | MD6173D |  | FA271TT | FA271R | MD6173D |
| MF 300 (2WD/4WD)      | 04 | FA271TT* | FA271R* | MD6173D | MD6173D |  | FA271TT | FA271R | MD6173D |
| MF 400 (4WD)          | 04 | FA271TT* | FA271R* | MD6173D | MD6173D |  | FA271TT | FA271R | MD6173D |
| MF 400 (Auto 4WD)     | 04 | FA271TT* | FA271R* | MD6173D | MD6173D |  | FA271TT | FA271R | MD6173D |
| MF 500 (4WD)          | 04 | FA271TT* | FA271R* | MD6173D | MD6173D |  | FA271TT | FA271R | MD6173D |
| MF 500 (Auto)         | 04 | FA271TT* | FA271R* | MD6173D | MD6173D |  | FA271TT | FA271R | MD6173D |
| MF 500 (Auto TBX 4WD) | 04 | FA271TT* | FA271R* | MD6173D | MD6173D |  | FA271TT | FA271R | MD6173D |

## MBK

|                            |       |         |         |         |          |  |         |         |        |
|----------------------------|-------|---------|---------|---------|----------|--|---------|---------|--------|
| CR 50 Z "Target"           | 91-95 | FA169   | FA169HH | MD904D  |          |  | Y503    |         |        |
| CS 50 Mach G/GCS 50 Z      | 02-06 | FA193   | FA193HH | MD943D  |          |  | Y503    |         |        |
| CT 50 S Sorriso            | 91-92 | Y503    |         |         |          |  | Y503    |         |        |
| CT 50 SS Sorriso           | 93-95 | Y503    |         |         |          |  | Y503    |         |        |
| CV 50 Evolis               | 97    | FA193   | FA193HH | MD904D  |          |  | Y503    |         |        |
| CW 50 Fizz 50              | 93-97 | FA193   | FA193HH | MD916D  |          |  | Y503    |         |        |
| CW 50 Booster              | 90-91 | Y503    |         |         |          |  | Y503    |         |        |
| CW 50 Booster              | 92-94 | Y503    |         |         |          |  | Y503    |         |        |
| CW 50 R "Booster Road"     | 94-95 | FA193   | FA193HH | MD904D  |          |  | Y503    |         |        |
| CW 50 RS "Booster NG"      | 95-98 | FA193   | FA193HH | MD916D  |          |  | Y503    |         |        |
| CW 50 RSX Booster Track    | 96-98 | FA193   | FA193HH | MD916D  |          |  | Y503    |         |        |
| CW 50 Booster Spirit       | 96-98 | FA193   | FA193HH | MD916D  |          |  | Y503    |         |        |
| CW 50 RS "Booster" Spirit  | 99-06 | FA193   | FA193HH | MD916D  |          |  | Y503    |         |        |
| CW 50 RSP "Rocket"         | 97-98 | FA193   | FA193HH | MD916D  |          |  | Y503    |         |        |
| CW 50 RS Booster NG        | 01-06 | FA193   | FA193HH | MD923D  |          |  | Y503    |         |        |
| CW 50 RS Booster Naked     | 05-06 | FA193   | FA193HH | MD916D  |          |  | Y503    |         |        |
| CW 50 Power Rocket         | 06    | FA193   | FA193HH | MD916D  |          |  | Y503    |         |        |
| CW 50 Booster (12" wheels) | 06    | FA193   | FA193HH | MD916D  |          |  | Y503    |         |        |
| CY 50 Forte/Forte Mufa     | 96-97 | FA169   | FA169HH | MD904D  |          |  | Y503    |         |        |
| EW 50 "Stunt"              | 00-06 | FA268   |         | MD923D  |          |  | Y503    |         |        |
| EW 50 "Stunt Naked"        | 05-06 | FA268   |         | MD923D  |          |  | Y503    |         |        |
| TZR 50 "X-Power"           | 00    | FA165TT | FA165HH |         | MD2067RS |  | FA101TT |         | MD2077 |
| TZR 50 X Power             | 03-06 | FA194   | FA194HH | MD672LS |          |  | FA115   | FA115HH | TBA    |
| YA 50 R "Forte"            | 94-95 | FA193   | FA193HH | MD904D  |          |  | Y503    |         |        |
| YA 50 TA "Sorriso"         | 95-96 | Y503    |         |         |          |  | Y503    |         |        |
| YE 50 Evolis               | 92-95 | FA193   | FA193HH | MD904D  |          |  | Y503    |         |        |
| YH 50 "Flipper"            | 98-06 | FA193   | FA193HH | MD928D  |          |  | Y503    |         |        |
| YM 50 "Fizz"               | 94-95 | FA193   | FA193HH | MD904D  |          |  | Y503    |         |        |
| YN 50 R Ovetto             | 98-06 | FA193   | FA193HH | MD943D  |          |  | Y503    |         |        |
| YQ 50 Nitro                | 97-06 | FA193   | FA193HH | MD923D  |          |  | FA268   |         | MD923D |

\*-2 Sets Required. ■ - Also available in MX-S race compound, see page 8. ✖ - Oversize and Supermoto disc available - see page 301.

**SAFETY WARNING-** DO NOT USE HH PADS ON REAR UNLESS ALSO USED ON FRONT TO AVOID BRAKE IMBALANCE.

**R** Suffix = High Durability Sintered Pad. **HH** Suffix = High Performance Sintered Pad. **G** Suffix = Grooved Shoe.  
**D** Suffix = Drilled Disc. **C** Suffix = Contoured Disc. **LS** Suffix = Left/Steel Disc. **RS** = Right/Steel Disc.

**BRAKE APPLICATIONS**

# Non-Japanese Built Motorcycles/Quads

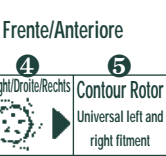

MBK contd.

|                     |       | 1                                  | 2                                  | 3                 | 4                   | 5  | 6                                  | 7                                  | 8                             | 9                             |
|---------------------|-------|------------------------------------|------------------------------------|-------------------|---------------------|--|------------------------------------|------------------------------------|-------------------------------|-------------------------------|
|                     |       | Sintered/HH Pads/<br>Grooved shoes | Sintered/HH Pads/<br>Grooved shoes | Left/Gauche/Links | Right/Droite/Rechts | Contour Rotor<br>Universal left and<br>right fitment | Sintered/HH Pads/<br>Grooved shoes | Sintered/HH Pads/<br>Grooved shoes | Contour Rotor<br>Rear fitment | Contour Rotor<br>Rear fitment |
| CV 80 Evolis        | 97    | FA193                              | FA193HH                            | MD904D            |                     |  | Y503                               |                                    |                               |                               |
| YN 100 Oveto        | 99-02 | FA193                              | FA193HH                            | MD943D            |                     |  | Y527                               |                                    |                               |                               |
| YQ 100 Nitro        | 01-03 | FA193                              | FA193HH                            | MD923D            |                     |  | Y527                               |                                    |                               |                               |
| YW 100 Booster 100  | 99-02 | FA169                              | FA169HH                            | N/A               |                     |  | Y527                               |                                    |                               |                               |
| X Limit Enduro      | 03-06 | FA350                              |                                    | MD6297D           |                     |  | FA350                              |                                    | MD6280D                       |                               |
| X Limit Supermoto   | 03-06 | FA194                              | FA194HH                            | MD6297D           |                     |  | FA350                              |                                    | MD6280D                       |                               |
| XC 125 T Flame      | 95-96 | Y527                               |                                    |                   |                     |  | Y503                               |                                    |                               |                               |
| XC 125 Flame 125    | 96-03 | FA101TT                            |                                    | N/A               |                     |  | Y503                               |                                    |                               |                               |
| XN 125/150 Doo Do   | 00-05 | FA193                              | FA193HH                            | MD907D            |                     |  | Y527                               |                                    |                               |                               |
| XP 125 Skycruiser   | 06    | FA181TT                            | FA181HH                            |                   | TBA                 |  | FA266                              | FA266HH                            | TBA                           |                               |
| XQ 125/150 Thunder  | 01-03 | FA181TT                            | FA181HH                            | MD957D            |                     |  | FA266                              | FA266HH                            | MD958D                        |                               |
| YP 125 D Skyliner   | 98-00 | FA181TT                            | FA181HH                            | MD907D            |                     |  | Y527                               |                                    |                               |                               |
| YP 125 D Skyliner   | 01-06 | FA181TT                            | FA181HH                            | MD907D            |                     |  | FA266                              | FA266HH                            | MD962D                        |                               |
| NXC 125 Flame X     | 04-06 | FA393                              |                                    |                   | MD986D              |  | Y533                               |                                    |                               |                               |
| XC 150 Vertex       | 97    | FA101TT                            |                                    |                   | N/A                 |  | Y527                               |                                    |                               |                               |
| YP 250 Skyliner     | 96-98 | FA199                              | FA199HH                            |                   | MD903D              |  | Y516                               |                                    |                               |                               |
| YP 250 Skyliner     | 98-99 | FA199                              | FA199HH                            |                   | MD903D              |  | FA275                              | FA275HH                            | MD927D                        |                               |
| YP 250 Skyliner 250 | 00-02 | FA199                              | FA199HH                            |                   | MD903D              |  | FA275                              | FA275HH                            | MD953D                        |                               |
| VP 300 R "Kilibre"  | 03-04 | FA181TT                            | FA181HH                            |                   | MD995D              |  | FA181TT                            | FA181HH                            | MD9104D                       |                               |
| YP 400 Skyliner     | 04    | FA199                              | FA199HH                            | MD9102D           |                     |  | FA408                              |                                    | TBA                           |                               |

## MH

|                                   |       |       |         |     |  |  |       |         |     |  |
|-----------------------------------|-------|-------|---------|-----|--|--|-------|---------|-----|--|
| Furia Max Enduro                  | 05-07 | FA115 | FA115HH | N/A |  |  | FA115 | FA115HH | N/A |  |
| Furia Max Supermotard             | 05-07 | FA167 | FA167HH | N/A |  |  | FA115 | FA115HH | N/A |  |
| RYZ 50 Pro Racing Enduro          | 06-07 | FA167 | FA167HH | N/A |  |  | FA115 | FA115HH | N/A |  |
| RYZ 50 Racing Super Motard        | 06-07 | FA167 | FA167HH | N/A |  |  | FA115 | FA115HH | N/A |  |
| RYZ 50 Pro Racing Urban Bike      | 06-07 | FA167 | FA167HH | N/A |  |  | FA115 | FA115HH | N/A |  |
| RYZ 50 Urban Bike                 | 06-07 | FA167 | FA167HH | N/A |  |  | FA115 | FA115HH | N/A |  |
| RYZ 50 Supermotard                | 06-07 | FA167 | FA167HH | N/A |  |  | FA115 | FA115HH | N/A |  |
| Arena 125 Pro Racing Super Motard | 06-07 | FA167 | FA167HH | N/A |  |  | FA115 | FA115HH | N/A |  |
| Arena 125 Pro Racing Urban Bike   | 06-07 | FA167 | FA167HH | N/A |  |  | FA115 | FA115HH | N/A |  |

## MINI MOTO

|  |  |       |  |     |  |  |       |  |     |  |
|--|--|-------|--|-----|--|--|-------|--|-----|--|
| Polini/Pasini/GRC Calipers (Round Type)          |  | FA293 |  | N/A |  |  | FA293 |  | N/A |  |
| Polini/Pasini/GRC Calipers (Square Two Pin Type) |  | FA352 |  | N/A |  |  | FA352 |  | N/A |  |

## MONDENAS

|           |       |         |  |     |  |  |      |  |  |  |
|-----------|-------|---------|--|-----|--|--|------|--|--|--|
| Kriss 110 | 00-02 | S603    |  |     |  |  | S603 |  |  |  |
| Kriss 115 |       | FA165TT |  | N/A |  |  | S603 |  |  |  |

## MONDIAL

|            |       |        |            |         |         |         |       |         |     |  |
|------------|-------|--------|------------|---------|---------|---------|-------|---------|-----|--|
| Piega 1000 | 02    | FA424* | FA424HH*   | N/A     | N/A     |         | FA95  | FA95HH  | N/A |  |
| Piega 1000 | 03-04 |        | FA322/4HH  | MD621LS | MD621RS | MD621C* | FA266 | FA266HH | TBA |  |
| Evo        | 04    |        | FA322/4HH* | MD621LS | MD621RS | MD621C* | FA266 | FA266HH | TBA |  |

## MONTESA/HONDA

|                      |       |       |        |     |  |  |       |       |     |  |
|----------------------|-------|-------|--------|-----|--|--|-------|-------|-----|--|
| Old Models           |       | N/A   |        |     |  |  | 889   |       |     |  |
| Cota 123/290/349     | -83   |       | 933G   |     |  |  |       | 933G  |     |  |
| Cota 123/200/242/349 | 84    |       | 937G   |     |  |  |       | 933G  |     |  |
| 250 4RT Cota         | 05-07 | FA303 |        | N/A |  |  | FA351 |       | N/A |  |
| Cota 307/335         | 88    | FA115 | FA115R | N/A |  |  | FA115 | FA115 | N/A |  |
| 348 Trial Enduro     |       |       | 933G   |     |  |  |       | 933G  |     |  |
| Honda 311 260cc      | 92-93 | FA115 | FA115R | N/A |  |  | FA47  | FA47R | N/A |  |
| Honda 314 R          | 94-96 | FA115 | FA115R | N/A |  |  | FA47  | FA47R | N/A |  |
| Honda 315R           | 97-00 | FA115 | FA115R | N/A |  |  | FA47  | FA47R | N/A |  |
| Honda 315 R          | 01-04 | FA303 |        | N/A |  |  | FA351 |       | N/A |  |

\*-2 Sets Required. ■ - Also available in MX-S race compound, see page 8. ✖ - Oversize and Supermoto disc available - see page 301.

**SAFETY WARNING-** DO NOT USE HH PADS ON REAR UNLESS ALSO USED ON FRONT TO AVOID BRAKE IMBALANCE.

# Non-Japanese Built Motorcycles/Quads



## MOTOBECA NE

|                       |     | Front/Avant/Vorn |                                    |                       | Frente/Anteriore        |  | Rear/Arrière/Hinten |                                    |   | Posterior/Posteriore          |  |
|-----------------------|-----|------------------|------------------------------------|-----------------------|-------------------------|--|---------------------|------------------------------------|---|-------------------------------|--|
|                       |     | 1                | 2                                  | 3                     | 4                       | 5  | 6                   | 7                                  | 8 | 9                             |  |
|                       |     |                  | Sintered/HH Pads/<br>Grooved shoes | Left/Gauche/Links<br> | Right/Droite/Rechts<br> | Contour Rotor<br>Universal left and<br>right fitment |                     | Sintered/HH Pads/<br>Grooved shoes |   | Contour Rotor<br>Rear fitment |  |
| 40 AE/41 AE           |     |                  | 878                                |                       |                         |  |                     |                                    |   |                               |  |
| 50 all mod. Atom hub  | 88- |                  | H322                               |                       |                         |  |                     |                                    |   |                               |  |
| 50 all mod. Leleu hub | 88- |                  | H322                               |                       |                         |  |                     |                                    |   |                               |  |
| 50 A/E/AE             |     |                  | 878                                |                       |                         |  |                     |                                    |   |                               |  |
| 51 SA/SAE/SV/SVE      |     |                  | 878                                |                       |                         |  |                     |                                    |   |                               |  |
| 51 SUE                |     |                  | 877                                |                       |                         |  |                     |                                    |   |                               |  |
| 51 VLM                |     |                  | 878                                |                       |                         |  |                     |                                    |   |                               |  |
| Or                    |     |                  | 878                                |                       |                         |  |                     |                                    |   |                               |  |
| Rock/Rock A           |     |                  | 877                                |                       |                         |  |                     |                                    |   |                               |  |
| Magnum/A/Racing       |     |                  | 877                                |                       |                         |  |                     |                                    |   |                               |  |

## MOTO GUZZI

|                                       |       |  |        |            |         |         |         |         |           |       |
|---------------------------------------|-------|--|--------|------------|---------|---------|---------|---------|-----------|-------|
| V 35/35 II/35 III (350)               | 77-87 |  | FA47*  | FA47HH*    | N/A     | N/A     |         | FA47    | FA47HH    | N/A   |
| V 35 C (350)                          | 82-86 |  | FA47*  | FA47HH*    | N/A     | N/A     |         | FA47    | FA47HH    | N/A   |
| V 35 Florida (350)                    | 86-90 |  | FA47*  | FA47HH*    | N/A     | N/A     |         | FA47    | FA47HH    | N/A   |
| NTX 350                               | 87-90 |  | FA47   | FA47HH     | N/A     | N/A     |         | FA47    | FA47HH    | N/A   |
| 350 Nevada                            | 92-97 |  | FA47*  | FA47HH*    | N/A     | N/A     |         | FA47    | FA47HH    | N/A   |
| 350 Nevada Club                       | 98-99 |  | FA47*  | FA47HH*    | N/A     | N/A     |         | FA47    | FA47HH    | N/A   |
| V 50/50 III (500)                     | 77-84 |  | FA47*  | FA47HH*    | N/A     | N/A     |         | FA47    | FA47HH    | N/A   |
| V 50 C (500)                          | 82-86 |  | FA47*  | FA47HH*    | N/A     | N/A     |         | FA47    | FA47HH    | N/A   |
| NTX 650                               | 87-90 |  | FA47   | FA47HH     | N/A     | N/A     |         | FA47    | FA47HH    | N/A   |
| V 65 C (650)                          | 82-85 |  | FA47*  | FA47HH*    | N/A     | N/A     |         | FA47    | FA47HH    | N/A   |
| V 65 Florida (650)                    | 86-92 |  | FA47*  | FA47HH*    | N/A     | N/A     |         | FA47    | FA47HH    | N/A   |
| V 75 (750)                            | 92-96 |  | FA47*  | FA47HH*    | N/A     | N/A     |         | FA47    | FA47HH    | N/A   |
| 750 SP                                | 90-92 |  | FA47*  | FA47HH*    | N/A     | N/A     |         | FA47    | FA47HH    | MD693 |
| 750 Targa                             | 90-92 |  | FA47*  | FA47HH*    | N/A     | N/A     |         | FA47    | FA47HH    | N/A   |
| Nevada 750                            | 91-92 |  | FA47*  | FA47HH*    | N/A     | N/A     |         | FA47    | FA47HH    | MD693 |
| Nevada 750 Club                       | 98-01 |  | FA47*  | FA47HH*    | N/A     | N/A     |         | FA266   | FA266HH   | N/A   |
| 750 Nevada/Club                       | 03-04 |  | FA244  | FA244HH    | MD614LS |         | MD614C  | FA266   | FA266HH   | N/A   |
| Nevada Classic 750 ie                 | 05-07 |  | FA244  | FA244HH    | MD614LS |         | MD614C  | FA266   | FA266HH   | N/A   |
| Nevada 750 Touring                    | 07    |  | FA244  | FA244HH    | MD614LS |         | MD614C  | FA266   | FA266HH   | N/A   |
| V 750 ie Brevia                       | 03-07 |  | FA244  | FA244HH    | MD614LS |         | MD614C  | FA266   | FA266HH   | N/A   |
| 850 II/III Le Mans                    | 78-84 |  | FA18*  | FA18HH*    | N/A     | N/A     |         | FA18    | FA18HH    | N/A   |
| 850 T3/T4/T5                          | 79-88 |  | FA18*  | FA18HH*    | N/A     | N/A     |         | FA18    | FA18HH    | N/A   |
| Brevia 850                            | 07    |  | FA244* | FA244HH*   | MD633LS | MD633RS | MD633C* | FA209/2 | FA209/2HH | TBA   |
| Griso 850                             | 07    |  | FA244* | FA244HH*   | MD621LS | MD621RS | MD621C* | FA209/2 | FA209/2HH | TBA   |
| Norge 850                             | 07    |  | FA244* | FA244HH*   | MD624LS | MD624RS |         | FA209/2 | FA209/2HH | TBA   |
| 940 Custom                            | 07    |  | FA244* | FA244HH*   | MD614LS | MD614RS | MD614C* | FA209/2 | FA209/2HH | TBA   |
| Daytona 1000                          | 92-95 |  | FA95*  | FA95HH*    | MD667LS | MD667RS |         | FA47    | FA47HH    | N/A   |
| Daytona 1000 RS                       | 97-98 |  | FA95*  | FA95HH*    | N/A     | N/A     |         | FA47    | FA47HH    | N/A   |
| California 1000 II/III                | 83-93 |  | FA18*  | FA18HH*    | N/A     | N/A     |         | FA18    | FA18HH    | N/A   |
| 1000 SP II/III                        | 83-94 |  | FA18*  | FA18HH*    | N/A     | N/A     |         | FA18    | FA18HH    | N/A   |
| 1000 GT                               | 87-91 |  | FA18*  | FA18HH*    | N/A     | N/A     |         | FA18    | FA18HH    | N/A   |
| 1000 'S'                              | 89-94 |  | FA18*  | FA18HH*    | N/A     | N/A     |         | FA18    | FA18HH    | N/A   |
| 1000 Le-Mans                          | 84-93 |  | FA18*  | FA18HH*    | N/A     | N/A     |         | FA18    | FA18HH    | MD693 |
| Strada 1000                           | 93-94 |  | FA18*  | FA18HH*    | N/A     | N/A     |         | FA18    | FA18HH    | MD693 |
| Quota 1000                            | 92-97 |  | FA126* | FA126HH*   | N/A     | N/A     |         | FA163   |           | N/A   |
| MGS-01 1000 cc                        | 03-04 |  |        | FA322/4HH* | MD621LS | MD621RS | MD621C* | FA266   | FA266HH   | N/A   |
| V10 Centauro                          | 97-99 |  | FA95*  | FA95HH*    | MD614LS | MD614RS | MD614C* | FA47    | FA47HH    | N/A   |
| Brevia V1100                          | 05    |  | FA244* | FA244HH*   | MD636LS | MD636RS |         | FA209/2 | FA209/2HH | N/A   |
| Brevia 1100                           | 05-06 |  | FA244* | FA244HH*   | MD633LS | MD633RS | MD633C* | FA209/2 | FA209/2HH | N/A   |
| Brevia 1100 (ABS)                     | 07    |  | FA2448 | FA244HH*   | MD624LS | MD633RS |         | FA209/2 | FA209/2HH | TBA   |
| California 1100                       | 94-97 |  | FA18*  | FA18HH*    | N/A     | N/A     |         | FA18    | FA18HH    | MD693 |
| California EVII                       | 97-01 |  | FA95*  | FA95HH*    | MD614LS | MD614RS | MD614C* | FA209/2 | FA209/2HH | N/A   |
| Fionda 1100                           | 05    |  |        | FA322/4HH* | MD614LS | MD614RS | MD614C* | FA266   | FA266HH   | N/A   |
| Griso 1100                            | 04    |  |        | FA322/4HH* | TBA     | TBA     |         | FA47    | FA47HH    | N/A   |
| Griso 1100                            | 05-07 |  | FA244* | FA244HH*   | MD621LS | MD621RS | MD621C* | FA209/2 | FA209/2HH | TBA   |
| Griso 1100 (8 valve) (Radial caliper) | 07    |  | FA244* | FA244HH*   | MD614C  | MD614C  |         | FA209/2 | FA209/2HH | TBA   |
| Sport 1100                            | 94-99 |  | FA95*  | FA95HH*    | MD614LS | MD614RS | MD614C* | FA47    | FA47HH    | N/A   |
| Sport Corsa 1100                      | 98-99 |  | FA95*  | FA95HH*    | N/A     | N/A     |         | FA47    | FA47HH    | N/A   |

\*-2 Sets Required. ■ - Also available in MX-S race compound, see page 8. ✖ - Oversize and Supermoto disc available - see page 301.

**SAFETY WARNING-** DO NOT USE HH PADS ON REAR UNLESS ALSO USED ON FRONT TO AVOID BRAKE IMBALANCE.

**R** Suffix = High Durability Sintered Pad. **HH** Suffix = High Performance Sintered Pad. **G** Suffix = Grooved Shoe.  
**D** Suffix = Drilled Disc. **C** Suffix = Contoured Disc. **LS** Suffix = Left/Steel Disc. **RS** = Right/Steel Disc.

**BRAKE APPLICATIONS**

# Non-Japanese Built Motorcycles/Quads



## MOTO GUZZI contd.

|  |       | 1                                  | 2                                  | 3                 | 4                   | 5  | 6                                  | 7                                  | 8                             | 9                             |
|--|-------|------------------------------------|------------------------------------|-------------------|---------------------|--|------------------------------------|------------------------------------|-------------------------------|-------------------------------|
|  |       | Sintered/HH Pads/<br>Grooved shoes | Sintered/HH Pads/<br>Grooved shoes | Left/Gauche/Links | Right/Droite/Rechts | Contour Rotor<br>Universal left and<br>right fitment | Sintered/HH Pads/<br>Grooved shoes | Sintered/HH Pads/<br>Grooved shoes | Contour Rotor<br>Rear fitment | Contour Rotor<br>Rear fitment |
| California Jackel 1100                       | 99-01 | FA244*                             | FA244HH*                           | MD614LS           | MD614RS             | MD614C*  | FA209/2                            | FA209/2HH                          | MD692                         |                               |
| California Special 1100                      | 99-01 | FA244*                             | FA244HH*                           | MD614LS           | MD614RS             | MD614C*  | FA209/2                            | FA209/2HH                          | MD692                         |                               |
| California Classic 1100                      | 07    | FA244*                             | FA244HH*                           | MD614LS           | MD614RS             | MD614C*  | FA209/2                            | FA209/2HH                          | MD692                         |                               |
| Quota 1100 ES                                | 99-01 | FA209/2*                           | FA209/2HH*                         | N/A               | N/A                 |  | FA181                              | FA181HH                            | N/A                           |                               |
| V11 (All models)                             | 99-06 | FA244*                             | FA244HH*                           | MD614LS           | MD614RS             | MD614C*  | FA47                               | FA47HH                             | MD692                         |                               |
| V 1100 Breva                                 | 04-05 | FA244*                             | FA244HH*                           | MD633LS           | MD633RS             | MD633C*  | FA266                              | FA266HH                            | N/A                           |                               |
| Le Mans (All models)                         | 01-04 | FA244*                             | FA244HH*                           | MD614LS           | MD614RS             | MD614C*  | FA47                               | FA47HH                             | MD692                         |                               |
| California Stone/Metal/Touring Stone         | 02-06 | FA244                              | FA244HH                            | MD614LS           |                     | MD614C   | FA209/2                            | FA209/2HH                          | MD692                         |                               |
| California EV/Special/Touring/Custom Touring | 02-06 | FA244*                             | FA244HH*                           | MD614LS           | MD614RS             | MD614C*  | FA209/2                            | FA209/2HH                          | MD692                         |                               |
| Norge 1200 (ABS) All models                  | 06-07 | FA244*                             | FA244HH*                           | MD624LS           | MD624RS             |  | FA209/2                            | FA209/2HH                          | MD692                         |                               |
| 1200 Sport                                   | 07    | FA244*                             | FA244HH*                           | MD621LS           | MD621RS             | MD621C*  | FA209/2                            | FA209/2HH                          | MD692                         |                               |
| MGS-01 Corsa                                 | 07    |                                    | FA322/4HH*                         | MD621LS           | MD621RS             | MD621C*  | FA266                              | FA266HH                            | N/A                           |                               |

## MOTO MORINI

|                       |       |        |          |         |         |         |       |         |     |  |
|-----------------------|-------|--------|----------|---------|---------|---------|-------|---------|-----|--|
| 125 Monocilindro      | 79-   | FA76   |          | N/A     |         |         | 821   |         |     |  |
| 125 KJ/T/KT/Kanguro   | 84-   | FA74   |          | N/A     |         |         | 821   |         |     |  |
| 250 All Models        | 71-   | FA76   |          | N/A     |         |         | 921   |         |     |  |
| 350 Coguaro           | 90-   | FA134  | FA134R   | N/A     |         |         | FA47  | FA47HH  | N/A |  |
| 350 Sport             | -79   | FA76*  |          | N/A     |         |         | FA76  |         | N/A |  |
| 350 Sport             | 80    | FA76   |          | N/A     |         |         | 921   |         |     |  |
| 350 Sport             | 81    | FA76   |          | N/A     |         |         | N/A   |         |     |  |
| 350 Sport             | 82-   | FA74   |          | N/A     |         |         | FA74  |         | N/A |  |
| 350 FT/Turismo        | 80-   | FA76   |          | N/A     |         |         | 921   |         |     |  |
| 350 Kanguro           | -83   |        | 927WG    |         |         |         |       | 927WG   |     |  |
| 350 Kanguro           | 84-86 | FA74   |          | N/A     |         |         |       | 927WG   |     |  |
| 350 "Kanguro"         | 87    | FA256  | FA256HH  | N/A     |         |         | FA47  |         | N/A |  |
| Excaliber 350/501 RLX | 93    | FA134  |          | N/A     |         |         | FA47  |         | N/A |  |
| Dart 350              | 87    | FA134  |          | N/A     |         |         | FA47  |         | N/A |  |
| 350 K2                |       | FA98*  |          | N/A     | N/A     |         | FA47  |         | N/A |  |
| 9 1/2 (998cc)         | 06-07 | FA244* | FA244HH* | MD614LS | MD614RS | MD614C* | FA266 | FA266HH | TBA |  |
| MM3 (1187cc)          | 07    | FA244* | FA244HH* | MD614LS | MD614RS | MD614C* | FA266 | FA266HH | TBA |  |
| Corsaro 1200          | 05-07 | FA244* | FA244HH* | TBA     | TBA     |         | FA266 | FA266HH | TBA |  |
| Corsaro 1200 Veloce   | 07    | FA244* | FA244HH* | MD614LS | MD614RS | MD614C* | FA266 | FA266HH | TBA |  |

## MOTO ROMA

|                          |       |         |         |        |        |  |         |         |        |  |
|--------------------------|-------|---------|---------|--------|--------|--|---------|---------|--------|--|
| Bee 50                   | 04-05 | FA169   |         | TBA    |        |  | TBA     |         |        |  |
| Blazer 50/100/110 "Quad" | 99-04 | H338*   | H338G*  |        |        |  | H330    | H330G   |        |  |
| Wasp 50                  | 99-05 | TBA     |         |        |        |  | Y503    |         |        |  |
| Go-Go 50                 | 97-05 | FA169   |         | MD904D |        |  | Y503    |         |        |  |
| Stinger 50               | 99-05 | FA169   |         | MD904D |        |  | Y503    |         |        |  |
| Scrambler 50             | 01    | FA169   |         | MD904D |        |  | Y503    |         |        |  |
| Road Runner 50/100       | 01-02 | FA169   |         | MD904D |        |  | Y503    |         |        |  |
| Grand Prix 50/100        | 99-03 | FA83TT* | FA83HH* | MD923D | MD923D |  | Y503    |         |        |  |
| Sport 90 "Quad"          | 01-03 | H338*   | H338G*  |        |        |  | H330    | H330G   |        |  |
| Quad Roadrunner 100      | 04    | H338*   | H338G*  |        |        |  | H330    | H330G   |        |  |
| Go-Go 110                | 01-02 | FA169   |         |        | N/A    |  | S603    |         |        |  |
| Grand Prix 125           | 01    | FA169   |         | TBA    |        |  | TBA     |         |        |  |
| Grand Prix 125           | 02    | FA83TT  | FA83HH  | MD923D |        |  | FA83TT  | FA83HH  | MD982D |  |
| MXR 125                  | 03    | FA56    |         | N/A    |        |  | S602    |         |        |  |
| MXR 125 B                | 04    | TBA     |         | N/A    |        |  | TBA     |         | N/A    |  |
| Road Runner 125          | 02-04 | FA135TT |         | TBA    |        |  | TBA     |         |        |  |
| SMX 125                  | 04-06 | FA167   | FA167HH | N/A    |        |  | FA115   | FA115HH | N/A    |  |
| Virage 125               | 01    | FA93    |         | N/A    |        |  | S602    |         |        |  |
| Geko 300 Quad            | 04-06 | FA83TT* | FA83R*  | N/A    | N/A    |  | FA165TT | FA165R  | N/A    |  |

## MOTRON

|            |    |       |         |     |  |  |     |  |  |  |
|------------|----|-------|---------|-----|--|--|-----|--|--|--|
| 50 Sting   | 98 | FA193 | FA193HH | TBA |  |  | TBA |  |  |  |
| 50 Syncro  | 98 | FA193 | FA193HH | TBA |  |  | TBA |  |  |  |
| 50 Thunder | 98 | FA193 | FA193HH | TBA |  |  | TBA |  |  |  |

\*-2 Sets Required. ■ - Also available in MX-S race compound, see page 8. ✖ - Oversize and Supermoto disc available - see page 301.

**SAFETY WARNING-** DO NOT USE HH PADS ON REAR UNLESS ALSO USED ON FRONT TO AVOID BRAKE IMBALANCE.

# Non-Japanese Built Motorcycles/Quads



## MH (MOTOR HISPANA)

|                    |       | Front/Avant/Vorn |         |     | Frente/Anteriore |   | Rear/Arrière/Hinten |         |     | Posterior/Posteriore |  |
|--------------------|-------|------------------|---------|-----|------------------|---|---------------------|---------|-----|----------------------|--|
|                    |       | 1                | 2       | 3   | 4                | 5 | 6                   | 7       | 8   | 9                    |  |
| Furia 6V           | 98-04 | FA115            | FA115R  | N/A |                  |   | FA115               | FA115R  | N/A |                      |  |
| RX 50 Super Racing | 00-07 | FA167            | FA167HH | N/A |                  |   | FA115               | FA115HH | N/A |                      |  |
| RYZ 50 Enduro      | 03-07 | FA115            | FA115HH | N/A |                  |   | FA115               | FA115HH | N/A |                      |  |
| RYZ 50 SM          | 04-07 | FA115            | FA115HH | N/A |                  |   | FA115               | FA115HH | N/A |                      |  |
| Arena 125 Enduro   | 05-07 | FA115            | FA115HH | N/A |                  |   | FA115               | FA115HH | N/A |                      |  |

## MV (AGUSTA)

|                                    |       |        |            |         |         |  |  |         |     |  |
|------------------------------------|-------|--------|------------|---------|---------|--|--|---------|-----|--|
| F4 750                             | 99-03 | FA424* | FA424HH*   | MD675LS | MD675RS |  |  | FA320HH | N/A |  |
| Brutale 750 S                      | 03-06 | FA424* | FA424HH*   | MD675LS | MD675RS |  |  | FA320HH | N/A |  |
| Brutale 910 S                      | 05-07 | FA424* | FA424HH*   | MD675LS | MD675RS |  |  | FA320HH | N/A |  |
| Brutale 910 R                      | 05-07 |        | FA322/4HH* | TBA     | TBA     |  |  | FA320HH | N/A |  |
| Brutale 910 Standard               | 05-07 | FA424* | FA424HH*   | MD675LS | MD675RS |  |  | FA320HH | N/A |  |
| Brutale 910 R Italia               | 07    |        | FA322/4HH* | TBA     | TBA     |  |  | FA320HH | N/A |  |
| F4 1000 (Nissin Calipers)          | 04-06 | FA424* | FA424HH*   | MD675LS | MD675RS |  |  | FA320HH | N/A |  |
| F4 1000 R                          | 07    |        | FA322/4HH* | TBA     | TBA     |  |  | FA320HH | N/A |  |
| F4 1000 R 1+1                      | 07    |        | FA322/4HH* | TBA     | TBA     |  |  | FA320HH | N/A |  |
| F4 1000 CC                         | 07    |        | FA447HH*   | TBA     | TBA     |  |  | FA320HH | N/A |  |
| F4 1000 (Brembo 4 piston calipers) | 06    |        | FA322/4HH* |         |         |  |  | FA320HH | N/A |  |

## MZ/MUZ

|                              |       |        |          |        |         |  |           |          |         |  |
|------------------------------|-------|--------|----------|--------|---------|--|-----------|----------|---------|--|
| Simpson                      | 80-94 | 980    |          |        |         |  | 980       |          |         |  |
| Moskito 50                   | 02    | FA83TT | FA83HH   | N/A    |         |  | TBA       |          |         |  |
| Moskito FB 50                | 97-03 | FA169  |          | MD904D |         |  | Y503      |          |         |  |
| Moskito SX JP50              | 00-03 | FA169  |          | MD904D |         |  | Y503      |          |         |  |
| VRS 50                       | 05    | TBA*   |          |        |         |  | TBA       |          |         |  |
| VRS 100                      | 05    | TBA*   |          |        |         |  | TBA       |          |         |  |
| Saxon 125                    | 93-97 | FA18   | FA18HH   |        | MD623RS |  | 978       |          |         |  |
| ETZ 125/150                  | 85-92 | FA18   | FA18HH   |        | N/A     |  | 979       |          |         |  |
| Mantizz 125 S                | 05-07 | FA323  | FA323HH  |        | TBA     |  | TBA       |          |         |  |
| Moskito 125                  | 02    | FA83TT | FA83HH   | N/A    |         |  | TBA       |          |         |  |
| RT 125 (All models)          | 02-07 | FA197  | FA197HH  | N/A    |         |  | FA197     | FA197HH  | N/A     |  |
| SM 125 (All models)          | 02-07 | FA228  | FA228HH  | N/A    |         |  | FA197     | FA197HH  | N/A     |  |
| SX 125 (All models)          | 02-07 | FA228  | FA228HH  | N/A    |         |  | FA197     | FA197HH  | N/A     |  |
| TS 125/150                   |       | 978    |          |        |         |  | 979       |          |         |  |
| VRT 125 Quad                 | 05    | TBA*   |          |        |         |  | FA165/2TT | FA165/2R | N/A     |  |
| Saxon 150                    | 95    | FA18   | FA18HH   |        | MD623RS |  | 978       |          |         |  |
| VRS 150 Quad                 | 05    | TBA*   |          |        |         |  | FA83TT    | FA83R    | N/A     |  |
| VRT 175 Quad                 | 05    | TBA*   |          |        |         |  | FA165/2TT | FA165/2R | N/A     |  |
| TS 250                       |       | 978    |          |        |         |  | 978       |          |         |  |
| 251 Fun                      | 95-96 | FA18   | FA18HH   |        | MD623RS |  | 978       |          |         |  |
| ETZ 250/300                  | 85-92 | FA18   | FA18HH   |        | N/A     |  | 978       |          |         |  |
| Saxon "Tour" 251/301         | 93-98 | FA18   | FA18HH   |        | MD623RS |  | 978       |          |         |  |
| Saxon 500 "All models"       | 93-98 | FA18   | FA18HH   |        | MD623RS |  | 978       |          |         |  |
| Skorpion Tour/Traveller      | 95-02 | FA95   | FA95HH   |        | MD619RS |  | FA47      | FA47HH   | MD637   |  |
| Skorpion Sport/Cup           | 95-01 | FA95   | FA95HH   |        | MD619RS |  | FA47      | FA47HH   | MD637   |  |
| Skorpion Replica             | 95-01 | FA95*  | FA95HH*  | TBA    | TBA     |  | FA47      | FA47HH   | MD637   |  |
| Baghira/Mastiff (All models) | 00-05 | FA177  |          | N/A    |         |  | FA173     |          | MD6284D |  |
| 660 Supermoto                | 06-07 | FA177  |          | N/A    |         |  | FA382     |          | TBA     |  |
| 1000 S                       | 03-07 | FA145* | FA145HH* | TBA    | TBA     |  | FA254     | FA254HH  | N/A     |  |
| 1000 SF                      | 05-07 | FA145* | FA145HH* | TBA    | TBA     |  | FA254     | FA254HH  | TBA     |  |
| 1000 SFX                     | 07    | FA145* | FA145HH* | TBA    | TBA     |  | FA254     | FA254HH  | TBA     |  |
| 1000 ST                      | 07    | FA145  | FA145HH  | TBA    | TBA     |  | FA254     | FA254HH  | TBA     |  |

## NORTON

|                       |       |       |         |         |         |  |      |        |     |  |
|-----------------------|-------|-------|---------|---------|---------|--|------|--------|-----|--|
| Commando              | 68-70 | 852   |         |         |         |  | 851  |        |     |  |
| Commando MK3          | 71-75 | FA27  |         | N/A     |         |  | FA27 |        | N/A |  |
| Commander             | 90    | FA88* | FA88HH* | N/A     | N/A     |  | FA88 | FA88HH | N/A |  |
| Formula One           | 90    | FA95* | FA95HH* | N/A     | N/A     |  | FA47 | FA47HH | N/A |  |
| F1 (Rotary) P55 Model | 90-91 | FA95* | FA95HH* | MD684LS | MD684RS |  | TBA  |        | TBA |  |

\*-2 Sets Required. ■ - Also available in MX-S race compound, see page 8. ✖ - Oversize and Supermoto disc available - see page 301.

**SAFETY WARNING-** DO NOT USE HH PADS ON REAR UNLESS ALSO USED ON FRONT TO AVOID BRAKE IMBALANCE.

**R** Suffix = High Durability Sintered Pad. **HH** Suffix = High Performance Sintered Pad. **G** Suffix = Grooved Shoe.  
**D** Suffix = Drilled Disc. **C** Suffix = Contoured Disc. **LS** Suffix = Left/Steel Disc. **RS** = Right/Steel Disc.

**BRAKE APPLICATIONS**

# Non-Japanese Built Motorcycles/Quads



## NVT

|                 | 1    | 2 | 3   | 4 | 5 | 6   | 7    | 8 | 9 |
|-----------------|------|---|-----|---|---|-----|------|---|---|
| Easy Rider      | 908  |   |     |   |   | 908 |      |   |   |
| 125/175 Rambler | FA76 |   | N/A |   |   |     | 821G |   |   |

## OSSA

|                               |     |       |        |     |  |  |       |       |     |
|-------------------------------|-----|-------|--------|-----|--|--|-------|-------|-----|
| 125 Cross                     | 74- |       | 934WG  |     |  |  | 990WG |       |     |
| 250 Cross/Fuego/Super Pioneer | 74- |       | 934WG  |     |  |  | 990WG |       |     |
| 350 TU-YO                     |     | FA50  |        | N/A |  |  | FA50  |       | N/A |
| pre 1980 models               |     |       | 934G   |     |  |  | 934G  |       |     |
| 81 onwards                    |     |       | 935G   |     |  |  | 936G  |       |     |
| 500                           | 92  | FA132 | FA132R | N/A |  |  | FA67  | FA67R | N/A |
| 560                           | 92  | FA67  | FA67R  | N/A |  |  | FA67  | FA67R | N/A |

## PEUGEOT

|  |       |          |          |            |         |  |        |          |        |
|--|-------|----------|----------|------------|---------|--|--------|----------|--------|
| Most Mofas/Mopeds                      |       | H322     |          |            |         |  | H322   |          |        |
| Fox/Fox L 50                           | 94-98 | H322     |          |            |         |  | H303   |          |        |
| 103 Pro, SP 3                          |       | H322     |          |            |         |  | H322   |          |        |
| Blaster                                | 05    | FA115    | FA115HH  | TBA        |         |  | H303   |          |        |
| Buxy M/Buxy RM (50cc)                  | 94-97 | FA193②   | FA193HH② | MD901/909① |         |  | H303   |          |        |
| Elyseo 50                              | 98-02 | FA115②   | FA115HH② | MD901D     |         |  | H303   |          |        |
| Elyseo 50                              | 03    | FA115    | FA115HH  | MD901D     |         |  | FA115  | FA115HH  | MD925D |
| Elystar 50 (TSDI)/Advantage            | 02-07 | FA115    | FA115HH  | MD947D     |         |  | FA350  |          | MD978D |
| Jet Force 50 (All models)              | 03-07 | FA115    | FA115HH  | MD985D     |         |  | FA115  | FA115HH  | MD984D |
| LooXoR 50 (All models with rear drum)  | 01-06 | FA115    | FA115HH  | MD954D     |         |  | H303   |          |        |
| LooXoR 50 TSDI (Rear disc)             | 06    | FA115    | FA115HH  | MD954D     |         |  | FA115  | FA115HH  | MD901D |
| Ludix One (10" wheels) 50cc            | 04-07 | H303     |          |            |         |  | H303   |          |        |
| Ludix Snake (10" wheels) 50cc          | 04-07 | FA115    | FA115HH  | MD992D     |         |  | H303   |          |        |
| Ludix Bullet (10" wheels) 50cc         | 04    | FA115    | FA115HH  | MD992D     |         |  | H303   |          |        |
| Ludix Trend (10" wheels) 50cc          | 04-07 | FA115    | FA115HH  | MD992D     |         |  | H303   |          |        |
| Ludix Elegance (14" wheels) 50cc       | 04-07 | FA115    | FA115HH  | MD993D     |         |  | H303   |          |        |
| Ludix Classic (14" wheels)             | 04-05 | H303     |          |            |         |  | H303   |          |        |
| Ludix Urban Track                      | 06-07 | FA115    | FA115HH  | MD992D     |         |  | H303   |          |        |
| Ludix Red Zone                         | 06    | FA115    | FA115HH  | MD992D     |         |  | H303   |          |        |
| Ludix Acid                             | 06    | FA115    | FA115HH  | MD992D     |         |  | H303   |          |        |
| Ludix Blaster                          | 05-07 | FA115    | FA115HH  |            | MD9105C |  | H303   |          |        |
| Metal-X 50 (All models)                | 02-03 | FA115    | FA115HH  | MD901D     |         |  | H303   |          |        |
| Speedake 50cc                          | 95-01 | FA115②   | FA115HH② | MD901/909① |         |  | H303   |          |        |
| Speed Fight (A) (50/100cc)             | 97-07 | FA115②   | FA115HH② | MD925D     |         |  | H303   |          |        |
| Speed Fight (B) (50/100cc)             | 97-07 | FA115②   | FA115HH② | MD925D     |         |  | FA115② | FA115HH② | MD925D |
| Squab 50cc                             | 95-01 | FA115②   | FA115HH② | MD901/909① |         |  | H303   |          |        |
| Street Board/Trekker 50cc (All models) | 00-06 | FA115②   | FA115HH② | MD901D     |         |  | H303   |          |        |
| SV 50/80/125 (Geo)                     | 91-92 | FA131/2② |          | MD901/909① |         |  | H303   |          |        |
| SV 50/80/125 (Geo)                     | 93-   | FA131/3② |          | MD901/909① |         |  | H303   |          |        |
| SV 50 J (Front drum model) (Geo)       | 91-95 | H303     |          |            |         |  | H303   |          |        |
| Vivacity 50/100 (All models)           | 99-07 | FA115②   | FA115HH② | MD901D     |         |  | H303   |          |        |
| XP S-6 "Enduro 50"                     | 02-07 | FA115    | FA115HH  | N/A        |         |  | FA115  | FA115HH  | N/A    |
| XPS-6 Supermotard                      | 03-07 | FA194    | FA194HH  | N/A        |         |  | FA115  | FA115HH  | N/A    |
| XPS Street 50                          | 05-07 | FA167    | FA167HH  | TBA        |         |  | FA115  | FA115HH  | TBA    |
| XP 6 Trail 50                          | 04    | FA115    | FA115HH  | N/A        |         |  | FA115  | FA115HH  | N/A    |
| XR 6-50                                | 02-07 | FA167    | FA167HH  | N/A        |         |  | FA115  | FA115HH  | N/A    |
| Zenith LS 50cc                         | 96-99 | FA115②   | FA115HH② | MD904/914③ |         |  | H303   |          |        |
| Zenith M/N 50cc                        | 96-00 | H303     |          |            |         |  | H303   |          |        |
| Elyseo 100                             | 98-02 | FA115    | FA115HH  | MD947D     |         |  | H303   |          |        |
| Elyseo 100                             | 03    | FA115    | FA115HH  | MD947D     |         |  | FA115  | FA115HH  | MD925D |
| LooXoR 100 (All models)                | 01-04 | FA115    | FA115HH  | MD954D     |         |  | FA115  | FA115HH  | MD901D |
| SV 100 L                               |       | FA116    |          | MD901D     |         |  | H303   |          |        |
| Elyseo 125/150 (Drum Rear model)       | 98-01 | FA115②   | FA115HH② | MD947D     |         |  | 857    |          |        |
| Elyseo 125/150 "Rear Disc Model"       | 03    | FA194    | FA194HH  | MD977D     |         |  | FA350  |          | MD978D |
| Elystar 125/150                        | 02-07 | FA194    | FA194HH  | MD980D     |         |  | FA350  |          | MD978D |
| Jet Force 125 (All models)             | 03-07 | FA194    | FA194HH  | MD980D     |         |  | FA350  |          | MD978D |
| LooXoR 125/150                         | 03-06 | FA324    |          | MD954D     |         |  | FA115  |          | MD901D |

\*-2 Sets Required. ■ - Also available in MX-S race compound, see page 8. ✖ - Oversize and Supermoto disc available - see page 301.

**SAFETY WARNING-** DO NOT USE HH PADS ON REAR UNLESS ALSO USED ON FRONT TO AVOID BRAKE IMBALANCE.



# Non-Japanese Built Motorcycles/Quads



## PEUGEOT contd.

|   |       | Front/Avant/Vorn |                                |                   | Frente/Anteriore    |  | Rear/Arrière/Hinten |                                |   | Posterior/Posteriore       |  |
|---|-------|------------------|--------------------------------|-------------------|---------------------|--|---------------------|--------------------------------|---|----------------------------|--|
|   |       | 1                | 2                              | 3                 | 4                   | 5  | 6                   | 7                              | 8 | 9                          |  |
|   |       |                  | Sintered/HH Pads/Grooved shoes | Left/Gauche/Links | Right/Droite/Rechts | Contour Rotor Universal left and right fitment |                     | Sintered/HH Pads/Grooved shoes |   | Contour Rotor Rear fitment |  |
| Ludix Ambition (14" wheels) 125cc                             | 04    | FA115            | FA115HH                        | MD901/909D        |                     |  | H303                |                                |   |                            |  |
| Satalis 125 (ABS Model)                                       | 06    | FA142            | FA142HH                        | TBA               |                     |  | FA350               |                                |   |                            |  |
| Satalis 125 4V Executive/Premium/City (4 stroke/4 valve)06-07 |       | FA194            | FA194HH                        | MD9111D           |                     |  | FA350               |                                |   | MD978                      |  |
| Satalis 125 Compressor (All models) (4 stroke)                | 06-07 | FA194            | FA194HH                        | MD9111D           |                     |  | FA350               |                                |   | MD978                      |  |
| XPS 125 CT  | 05-07 | FA115            | FA115HH                        | N/A               |                     |  | FA115               | FA115HH                        |   | N/A                        |  |
| XP 125 Street Evo 2   | 05    | FA167            | FA167HH                        | N/A               |                     |  | FA115               | FA115HH                        |   | N/A                        |  |
| Geopolis 250 (Nissin caliper)                                 | 06-07 | FA228            | FA228HH                        | MD9111D           |                     |  | FA228               | FA228HH                        |   | TBA                        |  |
| Geopolis 250 (AJP caliper)                                    | 06-07 | FA194            | FA194HH                        | MD9111D           | TBA                 |  | FA350               |                                |   | TBA                        |  |
| Satalis 250 (Nissin Calipers)                                 | 06-07 | FA228            | FA228HH                        | MD9111D           |                     |  | FA228               | FA228HH                        |   | TBA                        |  |
| Satalis 250 (AJP Calipers)                                    | 07    | FA194            | FA194HH                        | MD9111D           |                     |  | FA350               |                                |   | TBA                        |  |
| SV 250  | 01-02 | FA281            |                                | MD922D            |                     |  | FA140               |                                |   | MD1004                     |  |
| (Parking brake)   |       | H351             |                                |                   |                     |  |                     |                                |   |                            |  |
| TKR (All)   | 06-07 | FA115            | FA115HH                        | MD901D            |                     |  | H303                |                                |   |                            |  |
| Geopolis 400  | 07    | FA228            | FA228HH                        | MD9111D           |                     |  | FA228               | FA228HH                        |   | TBA                        |  |

- ① - Check if discs are either - counterbored (Leleu wheels) disc = MD909D or countersunk (Grimeca wheels) disc = MD901D
- ② - Caliper manufacture may vary - check old pad shape to select correct type. Hengtong = FA83TT AJP = FA115
- ③ - Check if discs are either - counterbored (Leleu wheels) disc = MD904D or countersunk (Grimeca wheels) disc = MD914D
- ④ - Check caliper manufacturer Hengtong = FA83TT Nissin = FA131/2
- (A) - All models with rear drum brake (B) - All models with front & rear disc

## PETRONAS

|     |    |  |            |     |     |  |       |         |     |  |
|-----|----|--|------------|-----|-----|--|-------|---------|-----|--|
| FP1 | 05 |  | FA322/4HH* | TBA | TBA |  | FA266 | FA266HH | TBA |  |
|-----|----|--|------------|-----|-----|--|-------|---------|-----|--|

## PHB

|     |    |       |        |     |  |  |      |       |     |  |
|-----|----|-------|--------|-----|--|--|------|-------|-----|--|
| 500 | 92 | FA132 | FA132R | N/A |  |  | FA67 | FA67R | N/A |  |
| 560 | 92 | FA67  | FA67R  | N/A |  |  | FA67 | FA67R | N/A |  |

## PGO

|                      |       |          |         |        |     |  |         |         |      |  |
|----------------------|-------|----------|---------|--------|-----|--|---------|---------|------|--|
| Big Max 50/90 R      | 94-06 | FA169    | FA169HH | MD904D |     |  | 897     |         |      |  |
| Bugrider 50 (Buggie) | 06    | FA416TT* | FA416R* | N/A    | N/A |  | FA54TT  | FA54R   | N/A  |  |
| Galaxy 25/50/90      | 94-   | FA83TT   | FA83HH  | TBA    |     |  | 897     |         |      |  |
| G-Max 50             | 05-07 | FA264    |         | N/A    |     |  | 897     |         |      |  |
| Mega 50              | 94-   | FA83TT   | FA83HH  | TBA    |     |  | 897     |         |      |  |
| My Bubu 50           | 03    | FA193    | FA193HH | MD904D |     |  | Y503    |         |      |  |
| EPS                  | 97    | FA169    | FA169HH | MD904D |     |  | 897     |         |      |  |
| Tornado 50/125       | 97    | FA169    | FA169HH | MD904D |     |  | 897     |         |      |  |
| Rodo Show 50/90      | 00-06 | FA193    | FA193HH | TBA    |     |  | 897     |         |      |  |
| Charge 125 A/B       | 01-02 | FA264    |         | MD923D |     |  | S624    |         |      |  |
| PMX 50/110           | 00-07 | FA264    |         | MD923D |     |  | 897     |         |      |  |
| T-Rex 50/110         | 99-06 | FA264    |         | MD923D |     |  | S624    |         |      |  |
| T/Rex 125/150        | 99-06 | FA264    |         | MD923D |     |  | S602    |         |      |  |
| Young Bubu 100/125   | 03-05 | FA264    |         | MD923D |     |  | S602    |         |      |  |
| Big Max 50 S         | 03-04 | FA264    |         | TBA    |     |  | 897     |         |      |  |
| X Rider 50/90/110    | 04-05 | TBA*     |         |        |     |  | FA83TT  | FA83R   | N/A  |  |
| X Rider 150          | 04-05 | H338*    | H338G*  |        |     |  | FA83TT  | FA83R   | N/A  |  |
| TR-3 50 (True)       | 03-04 | FA264    |         | N/A    |     |  | TBA     |         |      |  |
| My Bubu 100/125      | 03-05 | FA264    |         | N/A    |     |  | S602    |         |      |  |
| G-Max 125            | 06-07 | FA95     | FA95HH  | N/A    |     |  | FA197   | FA197HH | N/A  |  |
| i-Charge 125         | 03-05 | FA264    |         | N/A    |     |  | S602    |         |      |  |
| Ligero 125           | 06    | FA264    |         | MD923D |     |  | S624    |         |      |  |
| Bugxter BR150 A      | 05-07 | FA416TT* | FA416R* | N/A    | N/A |  | FA54TT  | FA54R   | N/A  |  |
| RS2 NKD              | 05    | FA194    | FA194HH |        | N/A |  | FA115   | FA115HH | N/A  |  |
| BR-200 Bug Rider     | 07    | FA416TT* | FA416R* | TBA    | TBA |  | FA431TT | FA431R  | TBA  |  |
| BR 250 Bugrider E    | 05-07 | FA416TT* | FA416R* | TBA    | TBA |  | FA431TT | FA431R  | TBA  |  |
| G-Max 250            | 06    | FA95     | FA95HH  | N/A    |     |  | FA197   | FA197HH | N/A  |  |
| BR 500i Racer        | 07    | TBA*     |         | TBA    | TBA |  | FA377*  | FA377R* | TBA* |  |

\*-2 Sets Required. ■ - Also available in MX-S race compound, see page 8. ✖ - Oversize and Supermoto disc available - see page 301.

**SAFETY WARNING-** DO NOT USE HH PADS ON REAR UNLESS ALSO USED ON FRONT TO AVOID BRAKE IMBALANCE.

**R** Suffix = High Durability Sintered Pad. **HH** Suffix = High Performance Sintered Pad. **G** Suffix = Grooved Shoe.  
**D** Suffix = Drilled Disc. **C** Suffix = Contoured Disc. **LS** Suffix = Left/Steel Disc. **RS** = Right/Steel Disc.

**BRAKE APPLICATIONS**

# Non-Japanese Built Motorcycles/Quads



## PIAGGIO

|  |       | Front/Avant/Vorn |                                    |                       | Frente/Anteriore        |  | Rear/Arrière/Hinten |                                    |        | Posterior/Posteriore          |  |
|--|-------|------------------|------------------------------------|-----------------------|-------------------------|--|---------------------|------------------------------------|--------|-------------------------------|--|
|  |       | 1                | 2                                  | 3                     | 4                       | 5  | 6                   | 7                                  | 8      | 9                             |  |
|  |       |                  | Sintered/HH Pads/<br>Grooved shoes | Left/Gauche/Links<br> | Right/Droite/Rechts<br> | Contour Rotor<br>Universal left and<br>right fitment |                     | Sintered/HH Pads/<br>Grooved shoes |        | Contour Rotor<br>Rear fitment |  |
| Boss 50  | 88-89 |                  | 909                                |                       |                         |  | V907                |                                    |        |                               |  |
| Bravo 50 Alloy Wheels                              | 73-81 |                  | 909                                |                       |                         |  | V907                |                                    |        |                               |  |
| Bravo 50 Spoke Wheels                              | 73-81 |                  | N/A                                |                       |                         |  | V907                |                                    |        |                               |  |
| Bravo 3  | 87-90 |                  | 909                                |                       |                         |  | N/A                 |                                    |        |                               |  |
| Ciao - All models                                  | 71-99 |                  | 909                                |                       |                         |  | V907                |                                    |        |                               |  |
| Ciao Mix Teen 50                                   | 96-01 |                  | 808                                |                       |                         |  | V907                |                                    |        |                               |  |
| Ciao 50 Catalitico                                 | 99-05 |                  | 909                                |                       |                         |  | V907                |                                    |        |                               |  |
| Diesis 50  | 01-05 |                  | FA115                              | FA115HH               | MD943D                  |  | 899                 |                                    |        |                               |  |
| FL2 50 HP  | 91-97 |                  | V903                               |                       |                         |  | V903                |                                    |        |                               |  |
| Fly 50 (2T/4T)                                     | 05-07 |                  | FA353                              |                       | MD910D                  |  | 816                 |                                    |        |                               |  |
| Free 50  | 92-00 |                  | 908                                |                       |                         |  | 806                 |                                    |        |                               |  |
| Free 50 (Disc model)                               | 95-00 |                  | FA116                              |                       | MD910D                  |  | 806                 |                                    |        |                               |  |
| Free Delivery 50                                   | 00-01 |                  | FA116                              |                       | MD910D                  |  | 899                 |                                    |        |                               |  |
| Free 50  | 02    |                  | FA193                              | FA193HH               | MD910D                  |  | 899                 |                                    |        |                               |  |
| Grillo 50  | 89-93 |                  | 909                                |                       |                         |  | V907                |                                    |        |                               |  |
| Liberty 50 (Grimeca Caliper) (2T)                  | 97-07 |                  | FA260                              | FA260HH               | MD956D                  |  | 816                 |                                    |        |                               |  |
| Liberty 50 (Heng Tong Caliper) (2T)                | 97-07 |                  | FA260                              | FA260HH               | MD956D                  |  | 816                 |                                    |        |                               |  |
| Liberty 50 4T (Grimeca Caliper)                    | 00-07 |                  | FA260                              | FA260HH               | MD956D                  |  | 816                 |                                    |        |                               |  |
| Liberty 50 4T (Heng Tong Caliper)                  | 00-07 |                  | FA260                              | FA260HH               | MD956D                  |  | 816                 |                                    |        |                               |  |
| Liberty S 50 (2T)                                  | 07    |                  | FA260                              | FA260HH               | MD956D                  |  | 816                 |                                    |        |                               |  |
| Liberty S 50 (4T)                                  | 07    |                  | FA260                              | FA260HH               | MD956D                  |  | 816                 |                                    |        |                               |  |
| NRG 50   | 94-96 |                  | FA193                              | FA193HH               | MD943D                  |  | 806                 |                                    |        |                               |  |
| NRG 50 RST (DT/DD) "MC2" (Rear drum)               | 96-97 |                  | FA193                              | FA193HH               | MD943D                  |  | 806                 |                                    |        |                               |  |
| NRG 50 RST (DD/DT) "MC2" (Rear drum)               | 98    |                  | FA193                              | FA193HH               | MD943D                  |  | 899                 |                                    |        |                               |  |
| NRG 50 RST (DD/DT) "MC2" (Rear disc)               | 98    |                  | FA193                              | FA193HH               | MD943D                  |  | FA260               | FA260HH                            | MD932D |                               |  |
| NRG 50 Extreme (Rear Drum Model)                   | 99-01 |                  | FA193                              | FA193HH               | MD924D                  |  | 899                 |                                    |        |                               |  |
| NRG 50 Extreme (Rear Disc Model)                   | 99-01 |                  | FA193                              | FA193HH               | MD924D                  |  | FA260               | FA260HH                            | MD932D |                               |  |
| NRG 50 DT "MC3" (Rear Drum Model)                  | 01-05 |                  | FA193                              | FA193HH               | MD924D                  |  | 899                 |                                    |        |                               |  |
| NRG 50 "MC3" DD (Rear Disc Model)                  | 01-05 |                  | FA193                              | FA193HH               | MD924D                  |  | FA260               | FA260HH                            | MD932D |                               |  |
| NRG 50 Power DD                                    | 05-07 |                  | FA83/2TT                           |                       | MD956D                  |  | FA260               |                                    | MD932D |                               |  |
| NRG 50 Power Pure Jet                              | 04-07 |                  | FA83/2TT                           |                       | MD956D                  |  | FA260               |                                    | MD932D |                               |  |
| NRG 50 Power DT                                    | 05-07 |                  | FA83/2TT                           |                       | MD956D                  |  | 899                 |                                    |        |                               |  |
| NTT 50   | 95-96 |                  | FA193                              | FA193HH               | MD943D                  |  | 806                 |                                    |        |                               |  |
| Quartz 50  | 92-96 |                  | FA186                              |                       | MD902D                  |  | 886                 |                                    |        |                               |  |
| S1 50 Alloy Wheels                                 | 79-88 |                  | 909                                |                       |                         |  | V907                |                                    |        |                               |  |
| S1 50 Spoke Wheels                                 | 79-88 |                  | N/A                                |                       |                         |  | V907                |                                    |        |                               |  |
| S1 50 FL2  | 91-97 |                  | 909                                |                       |                         |  | V907                |                                    |        |                               |  |
| S1 Mix 50  | 96-99 |                  | 808                                |                       |                         |  | V907                |                                    |        |                               |  |
| Scatto 50  | 92-93 |                  | 890                                |                       |                         |  | 890                 |                                    |        |                               |  |
| Sefera Base 50                                     | 91-93 |                  | 885                                |                       |                         |  | 806                 |                                    |        |                               |  |
| Sefera 50 Maquillage 2                             | 94    |                  | 885                                |                       |                         |  | 806                 |                                    |        |                               |  |
| Sefera 50 RST                                      | 95-97 |                  | FA255                              |                       | MD910D                  |  | 806                 |                                    |        |                               |  |
| Superbravo 50                                      | 85-90 |                  | 896                                |                       |                         |  | V907                |                                    |        |                               |  |
| Typhoon  | 94-97 |                  | FA193                              | FA193HH               | MD943D                  |  | 806                 |                                    |        |                               |  |
| Typhoon 50 X                                       | 98-99 |                  | FA193                              | FA193HH               | MD943D                  |  | 806                 |                                    |        |                               |  |
| Typhoon 50 XR                                      | 00    |                  | FA193                              | FA193HH               | MD943D                  |  | 899                 |                                    |        |                               |  |
| Typhoon 50   | 01-05 |                  | FA193                              | FA193HH               | MD943D                  |  | 899                 |                                    |        |                               |  |
| Typhoon 50   | 06-07 |                  | FA83/2TT                           |                       | MD943D                  |  | 893                 |                                    |        |                               |  |
| Velofax 50   | 96-99 |                  | 899                                |                       |                         |  | 809                 |                                    |        |                               |  |
| Zip 50 Base (Drum Model)                           | 92-96 |                  | 909                                |                       |                         |  | 806                 |                                    |        |                               |  |
| Zip Fast Rider                                     | 93-97 |                  | FA193                              | FA193HH               | MD904D                  |  | 806                 |                                    |        |                               |  |
| Zip & Zip 50 Bimodale                              | 94-97 |                  | 896                                |                       |                         |  | 806                 |                                    |        |                               |  |
| Zip 50 Base (Disc model)                           | 95-96 |                  | FA193                              | FA193HH               | MD904D                  |  | 806                 |                                    |        |                               |  |
| Zip 50 RST   | 96-99 |                  | 808                                |                       |                         |  | 899                 |                                    |        |                               |  |
| Zip 50 RST   | 96-99 |                  | FA260                              | FA260HH               | MD904D                  |  | 899                 |                                    |        |                               |  |
| Zip 50 SP  | 96-00 |                  | FA260                              | FA260HH               | MD910D                  |  | 899                 |                                    |        |                               |  |
| Zip 50 (Grimeca Caliper)/(Heng Tong Caliper) (A/C) | 00-07 |                  | FA260                              | FA260HH               | MD932D                  |  | 899                 |                                    |        |                               |  |
| Zip 50 SP (Liquid Cooled)                          | 01-06 |                  | FA260                              | FA260HH               | MD910D                  |  | 899                 |                                    |        |                               |  |
| Zip 50 Elettrico                                   | 02    |                  | FA193                              | FA193HH               | MD904D                  |  | 806                 |                                    |        |                               |  |
| SKR 80 City  | 99    |                  | 885                                |                       |                         |  | 806                 |                                    |        |                               |  |

\*-2 Sets Required. ■ - Also available in MX-S race compound, see page 8. ✖ - Oversize and Supermoto disc available - see page 301.

**SAFETY WARNING-** DO NOT USE HH PADS ON REAR UNLESS ALSO USED ON FRONT TO AVOID BRAKE IMBALANCE.

# Non-Japanese Built Motorcycles/Quads



PIAGGIO contd.

|  |            | Front/Avant/Vorn |                                    |                       | Frente/Anteriore        |   | Rear/Arrière/Hinten |                                    |        | Posterior/Posteriore          |  |
|--|------------|------------------|------------------------------------|-----------------------|-------------------------|---|---------------------|------------------------------------|--------|-------------------------------|--|
|  |            | 1                | 2                                  | 3                     | 4                       | 5   | 6                   | 7                                  | 8      | 9                             |  |
|  |            |                  | Sintered/HH Pads/<br>Grooved shoes | Left/Gauche/Links<br> | Right/Droite/Rechts<br> | Contour Rotor<br>Universal left and right fitment |                     | Sintered/HH Pads/<br>Grooved shoes |        | Contour Rotor<br>Rear fitment |  |
| Diesis 100   | 01-03      | FA115            | FA115HH                            | MD943D                |                         |   | S624                |                                    |        |                               |  |
| Fly 100  | 07         | FA353            |                                    | MD910D                |                         |   | 816                 |                                    |        |                               |  |
| Free 100   | 02         | FA193            | FA193HH                            | MD910D                |                         |   | 816                 |                                    |        |                               |  |
| Zip 100  | 07         | FA260            | FA260HH                            | MD910D                |                         |   | 899                 |                                    |        |                               |  |
| 125 GTR (VNL2)   | 74         | V901             |                                    |                       |                         |   | V903                |                                    |        |                               |  |
| Beverly B 125/200 (Heng Tong Caliper)                          | 02-06      | FA353            |                                    | MD961D                |                         |   | FA353               |                                    | MD961D |                               |  |
| Beverly B 125/200 (Grimeca Caliper)                            | 02-06      | FA194            | FA194HH                            | MD961D                |                         |   | FA194               | FA194HH                            | MD961D |                               |  |
| Beverly 125  | 07         | FA353            |                                    | MD961D                |                         |   |                     |                                    | MD961D |                               |  |
| Beverly S 125  | 07         | FA353            |                                    | MD961D                |                         |   | FA353               |                                    | MD961D |                               |  |
| Cosa CL/CLX 125/200  | 88-91      | 882              |                                    |                       |                         |   | 881                 |                                    |        |                               |  |
| Cosa 2 125   | 91-97      | 882              |                                    |                       |                         |   | 881                 |                                    |        |                               |  |
| Fly 125/150  | 05-07      | FA353            |                                    | MD910D                |                         |   | 816                 |                                    |        |                               |  |
| Hexagon 125/150  | 94-97      | FA193            | FA193HH                            | MD905D                |                         |   | 899                 |                                    |        |                               |  |
| Hexagon LX4 125  | 98-99      | FA194            | FA194HH                            | MD910D                |                         |   | 816                 |                                    |        |                               |  |
| Liberty 125/200  | 98-07      | FA260            | FA260HH                            | MD956D                |                         |   | 816                 |                                    |        |                               |  |
| Liberty S 125  | 07         | FA260            | FA260HH                            | MD956D                |                         |   | 816                 |                                    |        |                               |  |
| MP3 125 (All models)   | 06-07      | FA260*           | FA260HH*                           | MD9112D               | MD9112D                 |   | FA425               |                                    | MD960D |                               |  |
| Parking brake  |            | FA257/2          |                                    |                       |                         |   |                     |                                    |        |                               |  |
| Skipper LX 125/150   | 98-99      | FA194            | FA194HH                            | MD924D                |                         |   | 816                 |                                    |        |                               |  |
| Skipper 125/150  | 94-97      | FA186            |                                    | MD902D                |                         | 899   |                     |                                    |        |                               |  |
| Skipper ST 125/150 4T (Grimeca Caliper)                        | 00-04      | FA194            | FA194HH                            | MD924D                |                         |   | 816                 |                                    |        |                               |  |
| Skipper ST 125/150 4T (Heng Tong Caliper)                      | 00-04      | FA353            |                                    | MD924D                |                         |   | 816                 |                                    |        |                               |  |
| Sefera 125   | 95-97      | FA255            |                                    | MD910D                |                         |   | 899                 |                                    |        |                               |  |
| Super Hexagon GTX 125/180<br>(*11" wheels) (Grimeca calipers)  | 00         | FA194            | FA194HH                            | MD910D                |                         |   | FA321               |                                    | MD910D |                               |  |
| Super Hexagon GTX 125/180 (11" wheels)<br>(Heng Tong Calipers) | 00         | FA353            |                                    | MD910D                |                         |   | FA321               |                                    | MD910D |                               |  |
| Super Hexagon GTX 125/180 (12" wheels)                         | 01-03      | FA353            |                                    | MD960D                |                         |   | FA321               |                                    | MD956D |                               |  |
| Typhoon 125  | 95-98      | FA193            | FA193HH                            | MD943D                |                         |   | 899                 |                                    |        |                               |  |
| Typhoon 125 X-XR   | 99-00      | FA193            | FA193HH                            | MD943D                |                         |   | 899                 |                                    |        |                               |  |
| Typhoon 125  | 99-03      | FA193            | FA193HH                            | MD943D                |                         |   | 816                 |                                    |        |                               |  |
| X8 125   | 04-05      | FA353            |                                    | MD983D                |                         |   | FA266               |                                    | MD960D |                               |  |
| X8 125   | 05-06      | FA353            |                                    | MD983D                |                         |   | FA425               |                                    | MD960D |                               |  |
| X8 125 ie  | 07         | FA353            |                                    | MD961D                |                         |   | FA425               |                                    | MD960D |                               |  |
| X8 125/Street  | 07         | FA353            |                                    | MD961D                |                         |   | FA425               |                                    | MD960D |                               |  |
| X9 125   | 00-02      | FA266*           | FA266HH*                           | MD959D                | MD959D                  |   | FA266               | FA266HH                            | MD959D |                               |  |
| X9 125 Evolution   | 03-05      | FA266*           | FA266HH*                           | MD959D                | MD959D                  |   | FA266               | FA266HH                            | MD959D |                               |  |
| X9 125   | Left 06-07 | FA353            |                                    | MD959D                |                         |   | FA425               |                                    | MD959D |                               |  |
| X9 125   | Right      | FA418            |                                    |                       | MD959D                  |   |                     |                                    |        |                               |  |
| Zip 125  | 00-04      | FA260            | FA260HH                            | MD910D                |                         |   | 899                 |                                    |        |                               |  |
| 150 Sprint Veloce (VLB1)                                       | 74         | V901             |                                    |                       |                         |   | V903                |                                    |        |                               |  |
| Cosa CL/CLX 150  | 88-91      | 882              |                                    |                       |                         |   | 881                 |                                    |        |                               |  |
| Cosa 2 150   | 91-97      | 882              |                                    |                       |                         |   | 881                 |                                    |        |                               |  |
| 150 Super (VBC1)   | 74         | V905             |                                    |                       |                         |   | V902                |                                    |        |                               |  |
| X8 150 Street  | 07         | FA353            |                                    | MD961D                |                         |   | FA425               |                                    | MD960D |                               |  |
| Hexagon LX 180   | 98-99      | FA194            | FA194HH                            | MD910D                |                         |   | 816                 |                                    |        |                               |  |
| Hexagon LXT 180  | 98-99      | FA194            | FA194HH                            | MD910D                |                         |   | 816                 |                                    |        |                               |  |
| X9 180 Amalfi  | 00-03      | FA266*           | FA266HH*                           | MD959D                | MD959D                  |   | FA266               | FA266HH                            | MD959D |                               |  |
| Cosa CL/CLX 200  | 88-91      | 882              |                                    |                       |                         |   | 881                 |                                    |        |                               |  |
| Cosa 2 200   | 91-97      | 882              |                                    |                       |                         |   | 881                 |                                    |        |                               |  |
| Liberty S 200  | 07         | FA260            | FA260HH                            | MD956D                |                         |   | 816                 |                                    |        |                               |  |
| Rally 200 (VSE1)   | 74         | V901             |                                    |                       |                         |   | V903                |                                    |        |                               |  |
| X8 200   | 04-05      | FA353            |                                    | MD983D                |                         |   | FA266               |                                    | MD960D |                               |  |
| X9 200   | 02-03      | FA266*           | FA266HH*                           | MD959D                | MD959D                  |   | FA266               | FA266HH                            | MD959D |                               |  |
| X9 200 Evolution   | 03-04      | FA266*           | FA266HH*                           | MD959D                | MD959D                  |   | FA266               | FA266HH                            | MD959D |                               |  |
| Beverly 250  | 06         | FA353            |                                    | MD961D                |                         |   | FA353               |                                    | MD961D |                               |  |
| Beverly 250 ie   |            | FA353            |                                    | MD961D                |                         |   | FA353               |                                    | MD961D |                               |  |
| Beverly S 250 ie   | 07         | FA353            |                                    | MD961D                |                         |   | FA353               |                                    | MD961D |                               |  |
| Hexagon GT 250   | 98-99      | FA194            | FA194HH                            | MD910D                |                         |   | H350                |                                    |        |                               |  |
| MP3 250 ie (All models)  | 06-07      | FA260*           | FA260HH*                           | MD9112D               | MD9112D                 |   | FA425               |                                    | MD960D |                               |  |

\*-2 Sets Required. ■ - Also available in MX-S race compound, see page 8. ✖ - Oversize and Supermoto disc available - see page 301.

**SAFETY WARNING-** DO NOT USE HH PADS ON REAR UNLESS ALSO USED ON FRONT TO AVOID BRAKE IMBALANCE.

**R** Suffix = High Durability Sintered Pad. **HH** Suffix = High Performance Sintered Pad. **G** Suffix = Grooved Shoe.  
**D** Suffix = Drilled Disc. **C** Suffix = Contoured Disc. **LS** Suffix = Left/Steel Disc. **RS** = Right/Steel Disc.

BRAKE  
APPLICATIONS

# Non-Japanese Built Motorcycles/Quads



Front/Avant/Vorn



Frente/Anteriore

Rear/Arrière/Hinten



Posterior/Posteriore

1

2

3

4

5

6

7

8

9

## PIAGGIO contd.

|   |       |       | 1                                  | 2                                  | 3                 | 4                   | 5  | 6                                  | 7                                  | 8                             | 9 |
|---|-------|-------|------------------------------------|------------------------------------|-------------------|---------------------|--|------------------------------------|------------------------------------|-------------------------------|---|
|   |       |       | Sintered/HH Pads/<br>Grooved shoes | Sintered/HH Pads/<br>Grooved shoes | Left/Gauche/Links | Right/Droite/Rechts | Contour Rotor<br>Universal left and<br>right fitment | Sintered/HH Pads/<br>Grooved shoes | Sintered/HH Pads/<br>Grooved shoes | Contour Rotor<br>Rear fitment |   |
| Super Hexagon GTX 250                     | 00-02 |       | FA194                              | FA194HH                            | MD910D            |                     |  | FA321                              |                                    | MD910D                        |   |
| X8 250 ie                                 | 05-06 |       | FA353                              |                                    | MD983D            |                     |  | FA425                              |                                    | MD960D                        |   |
| X8 250 ie                                 | 07    |       | FA353                              |                                    | MD961D            |                     |  | FA425                              |                                    | MD960D                        |   |
| X9 250 (13" rear wheel)                   | 00-04 |       | FA266*                             | FA266HH*                           | MD959D            | MD959D              |  | FA266                              | FA266HH                            | MD959D                        |   |
| X9 250 (Linked brake F & R wheel 14" dia) | 04    |       | FA181TT*                           | FA181HH*                           | MD983D            | MD983D              |  | FA266                              | FA266HH                            | MD960D                        |   |
| X9 250                                    | 05-06 | Left  | FA353                              |                                    | MD959D            |                     |  | FA425                              |                                    | MD959D                        |   |
|   |       | Right | FA418                              |                                    |                   | MD959D              |  |                                    |                                    |                               |   |
| Beverley 400 ie                           | 07    |       | FA181TT                            | FA181HH                            | MD961D            |                     |  | FA353                              |                                    | MD960D                        |   |
| MP3 400 ie (All models)                   | 07    |       | FA260*                             | FA260HH*                           | MD9112D           | MD9112D             |  | FA425                              |                                    | MD960D                        |   |
| Parking brake                             |       |       | FA257/2                            |                                    |                   |                     |  |                                    |                                    |                               |   |
| Trackmaster 400 Quad                      | 06    |       | FA395TT*                           | FA395R*                            | MD6173D           | MD6173D             |  | FA395TT                            | FA395R                             | MD6173D                       |   |
| Parking brake                             |       |       | FA271TT                            | FA271R                             |                   |                     |  |                                    |                                    |                               |   |
| X8 400 ie                                 | 07    |       | FA353                              |                                    | MD961D            |                     |  | FA425                              |                                    | MD960D                        |   |
| Beverley B 500                            | 02-05 |       | FA266*                             | FA266HH*                           | MD961D            | MD961D              |  | FA266                              | FA266HH                            | MD960D                        |   |
| Beverley 500                              | 06    |       | FA266*                             | FA266HH*                           | MD961D            | MD961D              |  | FA425                              |                                    | MD960D                        |   |
| Beverley Cruiser 500 ie                   | 07    |       | FA266*                             | FA266HH*                           | MD961D            | MD961D              |  | FA266                              | FA266HH                            | MD960D                        |   |
| X9 500/500 SL                             | 00-02 |       | FA266*                             | FA266HH*                           | MD961D            | MD961D              |  | FA266                              | FA266HH                            | MD960D                        |   |
| X9 500 cc Evolution (inc ABS)             | 03-06 |       | FA181TT*                           | FA181HH*                           | MD983D            | MD983D              |  | FA266                              | FA266HH                            | MD960D                        |   |
| X9 500 ie                                 | 07    |       | FA181TT*                           | FA181HH*                           | MD961D            | MD961D              |  | FA266                              | FA266HH                            | MD960D                        |   |

## PRAGA

|                 |    |  |         |         |     |  |  |         |         |     |  |
|-----------------|----|--|---------|---------|-----|--|--|---------|---------|-----|--|
| 250 Enduro      | 03 |  | FA181TT | FA181R■ | N/A |  |  | FA208TT | FA208R■ | N/A |  |
| 610 Enduro      | 03 |  | FA181TT | FA181R■ | N/A |  |  | FA208TT | FA208R■ | N/A |  |
| 610 Supermotard | 03 |  | FA95    | FA95HH  | N/A |  |  | FA208TT |         | N/A |  |

## PUCH

|                           |       |  |      |       |     |     |  |      |       |  |  |
|---------------------------|-------|--|------|-------|-----|-----|--|------|-------|--|--|
| MS 50/50 L                |       |  | 970  |       |     |     |  | 970  |       |  |  |
| M50 Grand Prix            | 74-77 |  | TBA  |       |     |     |  | TBA  |       |  |  |
| M50 SDP Spoke Wheel       | 75-77 |  | FA50 |       |     | N/A |  | TBA  |       |  |  |
| M50 SDP Cast Wheel        | 75-77 |  | FA50 |       |     | N/A |  | TBA  |       |  |  |
| VS/DS/DZS/DSK 50          |       |  | 856  |       |     |     |  | 856  |       |  |  |
| 50 KA/K2/K25/K3T/MSP      |       |  | 972  |       |     |     |  | 972  |       |  |  |
| Monza 4 SL/GP             |       |  | H322 |       |     |     |  | H322 |       |  |  |
| Monza 50                  | 83-   |  | 933  |       |     |     |  | 933  |       |  |  |
| Monza 50 Alu Wheels       | 84-   |  |      | 936WG |     |     |  |      | 936WG |  |  |
| Imola X/GX                |       |  | FA50 |       | N/A |     |  | H322 |       |  |  |
| Cobra 80/80-8/80-6 GT/GTL |       |  | FA50 |       | N/A |     |  | H322 |       |  |  |
| Maxi                      |       |  | H322 |       |     |     |  | H322 |       |  |  |
| Maxi "Executive"          |       |  | 908  |       |     |     |  | 908  |       |  |  |

## QUADZILLA

|                       |       |  |       |        |     |  |  |        |       |     |  |
|-----------------------|-------|--|-------|--------|-----|--|--|--------|-------|-----|--|
| Buzz 50               | 03-07 |  | N/A   |        |     |  |  | H302   | H302G |     |  |
| Micro RV 50           | 06    |  | N/A   |        |     |  |  | N/A    |       | N/A |  |
| Ram R50               | 03-05 |  | TBA*  |        |     |  |  | FA83TT | FA83R | N/A |  |
| X50                   | 06-07 |  | Y503* | Y503G* |     |  |  | FA83TT | FA83R | N/A |  |
| WK 70                 | 06    |  | S614  | S614G  |     |  |  | S614   | S614G |     |  |
| Black Max M100 (S.E.) | 06    |  | Y503* | Y503G* |     |  |  | FA83TT | FA83R | N/A |  |
| R100                  | 06-07 |  | Y527* | Y527G* |     |  |  | FA83TT | FA83R | N/A |  |
| Ram R100              | 03-05 |  | TBA*  |        |     |  |  | FA83TT | FA83R | N/A |  |
| Ram R100 E            | 03-05 |  | TBA*  |        |     |  |  | FA83TT | FA83R | N/A |  |
| Shark 100 (X100)      | 03-05 |  | TBA*  |        |     |  |  | FA83TT | FA83R | N/A |  |
| Magmax                | 03-05 |  | TBA*  |        |     |  |  | FA83TT | FA83R | N/A |  |
| Pro Shark             | 06-07 |  | Y503* | Y503G* |     |  |  | FA83TT | FA83R | N/A |  |
| Pro Shark Type R      | 06    |  | Y503* | Y503G* |     |  |  | FA83TT | FA83R | N/A |  |
| Pro Shark-E           | 06    |  | Y503* | Y503G* |     |  |  | FA83TT | FA83R | N/A |  |
| Pro Shark 100 R MX    | 07    |  | Y503* | Y503G* |     |  |  | FA83TT | FA83R | N/A |  |
| X 100 E (XLC)         | 06-07 |  | Y503* | Y503G* |     |  |  | FA83TT | FA83R | N/A |  |
| Helix 110             | 06-07 |  | TBA   |        |     |  |  | TBA    |       | N/A |  |
| WK 110                | 05-06 |  | FA169 |        | N/A |  |  | FA86   |       | N/A |  |
| WK 125 (All models)   | 06    |  | FA169 |        | N/A |  |  | FA86   |       | N/A |  |

\*-2 Sets Required. ■ - Also available in MX-S race compound, see page 8. ✖ - Oversize and Supermoto disc available - see page 301.

**SAFETY WARNING-** DO NOT USE HH PADS ON REAR UNLESS ALSO USED ON FRONT TO AVOID BRAKE IMBALANCE.

# Non-Japanese Built Motorcycles/Quads



## QUADZILLA contd.

|                            |       | Front/Avant/Vorn |         | Frente/Anteriore |     | Rear/Arrière/Hinten |         | Posterior/Posteriore |      |   |
|----------------------------|-------|------------------|---------|------------------|-----|---------------------|---------|----------------------|------|---|
|                            |       | 1                | 2       | 3                | 4   | 5                   | 6       | 7                    | 8    | 9 |
| BR 150 E Bugrider          | 04-06 | FA416TT*         | FA416R* | N/A              | N/A |                     | FA54TT  | FA54R                | N/A  |   |
| Ram R170                   | 03-05 | TBA*             |         |                  |     |                     | FA135TT | FA135R               | N/A  |   |
| Ram R170 E Stinger         | 03-05 | TBA*             |         |                  |     |                     | FA135TT | FA135R               | N/A  |   |
| Stinger R170E              | 06    | Y503*            | Y503G*  |                  |     |                     | FA135TT | FA135R               | N/A  |   |
| 4 Cross 200 E SUV          | 06-07 | FA83TT*          | FA83R*  | N/A              | N/A |                     | FA67TT  | FA67R                | N/A  |   |
| R 200 E Stinger            | 06-07 | TBA*             |         | N/A              | N/A |                     | TBA     |                      | N/A  |   |
| ST 200 E (Automatic)       | 06-07 | Y503*            | Y503G*  |                  |     |                     | FA135TT | FA135R               | N/A  |   |
| ST 200 E (5 speed manual)  | 06-07 | FA83TT*          | FA83R*  | N/A              | N/A |                     | FA67TT  | FA67R                | N/A  |   |
| 250 E                      | 06    | FA83TT*          | FA83R*  | N/A              | N/A |                     | FA67TT  | FA67R                | N/A  |   |
| BR 250 E Bugrider          | 05-06 | FA416TT*         | FA416R* | N/A              | N/A |                     | FA431TT | FA431R               | N/A  |   |
| Ram R250                   | 03-05 | TBA*             |         |                  |     |                     | FA135TT | FA135R               | N/A  |   |
| Ram R250E Stinger          | 03-05 | TBA*             |         |                  |     |                     | FA135TT | FA135R               | N/A  |   |
| Stinger R250 E             | 06    | FA83TT*          | FA83R*  | N/A              | N/A |                     | FA67TT  | FA67R                | N/A  |   |
| XRV 250 (Off Road)         | 06    | FA416TT*         | FA416R* | N/A              | N/A |                     | FA431TT | FA431R               | N/A  |   |
| XRV 250 E                  | 06-07 | FA416TT*         | FA416R* | N/A              | N/A |                     | FA431TT | FA431R               | N/A  |   |
| 270 E Autosport            | 06-07 | TBA*             |         | N/A              | N/A |                     | TBA     |                      | N/A  |   |
| 300 E SUV (Automatic)      | 06    | FA159TT*         | FA159R* | N/A              | N/A |                     | FA270TT | FA270R               | N/A  |   |
| 300 E (4x4) (Auto)         | 06-07 | FA159TT*         | FA159R* | N/A              | N/A |                     | FA270TT | FA270R               | N/A  |   |
| 300 E XLC                  | 06-07 | FA83TT*          | FA83R*  | N/A              | N/A |                     | FA67TT  | FA67R                | N/A  |   |
| 300 SE 4 Valve             | 06-07 | FA83TT*          | FA83R*  | N/A              | N/A |                     | FA67TT  | FA67R                | N/A  |   |
| 300 E SUV (Manual)         | 06-07 | FA159TT*         | FA159R* | N/A              | N/A |                     | FA270TT | FA270R               | N/A  |   |
| Quadzilla 300              | 04-05 | FA159TT*         | FA159R* | N/A              | N/A |                     | FA270TT | FA270R               | N/A  |   |
| WK 300                     | 06    | FA135TT          | FA135R  | TBA              |     |                     | FA165TT | FA165R               | TBA  |   |
| WK SR 300                  | 06    | TBA*             |         | N/A              | N/A |                     | TBA     |                      | N/A  |   |
| 320 E 4x4                  | 07    | TBA*             |         | N/A              | N/A |                     | TBA     |                      | N/A  |   |
| Crossbone 400              | 07    | TBA*             |         | N/A              | N/A |                     | TBA     |                      | N/A  |   |
| Crossbone Beach 400        | 07    | TBA*             |         | N/A              | N/A |                     | TBA     |                      | N/A  |   |
| 450 R                      | 06-07 | FA83TT*          | FA83R*  | TBA              | TBA |                     | FA67TT  | FA67R                | TBA  |   |
| 500 4x4                    | 06-07 | FA159TT*         | FA159R* | N/A              | N/A |                     | FA270TT | FA270R               | N/A  |   |
| BR 500 Bug Racer           | 07    | TBA*             |         | N/A              | N/A |                     | TBA*    |                      | N/A* |   |
| <b>RIEJU</b>               |       |                  |         |                  |     |                     |         |                      |      |   |
| MRX 50 Castrol             | 01-02 | FA167            | FA167HH | N/A              |     |                     | FA115   | FA115HH              | N/A  |   |
| MRX 50                     | 03-06 | FA115            | FA115R  | N/A              |     |                     | FA115   | FA115R               | N/A  |   |
| MRX 50 Pro/Top             | 04-07 | FA194            | FA194HH | N/A              |     |                     | FA115   | FA115HH              | N/A  |   |
| NKD 50                     | 07    | FA374            |         | N/A              |     |                     | FA115   | FA115HH              | TBA  |   |
| RS1 50cc                   | 97-00 | FA115            | FA115HH | N/A              |     |                     | FA115   | FA115HH              | N/A  |   |
| RS1 50cc                   | 01-04 | FA167            | FA167HH | N/A              |     |                     | FA115   | FA115HH              | N/A  |   |
| RR 50cc "Thunderfire"      | 97-02 | FA115            | FA115HH | N/A              |     |                     | FA115   | FA115HH              | N/A  |   |
| RR 50 'Castrol'            | 00-02 | FA167            | FA167HH | N/A              |     |                     | FA115   | FA115HH              | N/A  |   |
| RR 50 Sport                | 03-06 | FA115            | FA115HH | N/A              |     |                     | FA115   | FA115HH              | N/A  |   |
| RRX 50                     | 06-07 | FA115            | FA115HH | N/A              |     |                     | FA115   | FA115HH              | N/A  |   |
| RS2 "Matrix" (50CC)        | 02-07 | FA374            |         |                  | N/A |                     | FA115   | FA115HH              | N/A  |   |
| SMX 50                     | 02-06 | FA115            | FA115R  | N/A              |     |                     | FA115   | FA115R               | N/A  |   |
| SMX 50 Pro Supermotard/Top | 04-07 | FA194            | FA194HH | N/A              |     |                     | FA115   | FA115HH              | N/A  |   |
| Spike 50                   | 04-06 | FA115            | FA115HH | N/A              |     |                     | FA115   | FA115HH              | N/A  |   |
| Spike 50 Pro               | 04    | FA167            | FA167HH | N/A              |     |                     | FA115   | FA115HH              | N/A  |   |
| Spike X50                  | 06-07 | FA115            | FA115HH | N/A              |     |                     | FA115   | FA115HH              | N/A  |   |
| MRX 125                    | 02-07 | FA167            | FA167HH | N/A              |     |                     | FA115   | FA115HH              | N/A  |   |
| RS2 125                    | 06-07 | FA374            |         |                  | N/A |                     | FA115   | FA115HH              | N/A  |   |
| SMX 125                    | 02-07 | FA167            | FA167HH | N/A              |     |                     | FA115   | FA115HH              | N/A  |   |
| 125 NKD                    | 06-07 | FA374            |         |                  | N/A |                     | FA115   | FA115HH              | N/A  |   |
| Tango 125                  | 06-07 | FA266            | FA266HH | N/A              |     |                     | TBA     |                      | N/A  |   |
| MRX 250/450                | 06    | TBA              |         | TBA              |     |                     | TBA     |                      | TBA  |   |
| <b>ROXON</b>               |       |                  |         |                  |     |                     |         |                      |      |   |
| Duel 50 SM                 | 06    | FA115            | FA115HH | N/A              |     |                     | FA115   | FA115HH              | N/A  |   |
| Duel 50 TT                 | 06    | FA115            | FA115HH | N/A              |     |                     | FA115   | FA115HH              | N/A  |   |
| Fox 50 (Quad)              | 04-06 | H338*            | H338G*  |                  |     |                     | H307    | H307G                |      |   |
| Go-Kart Enfant X-Cube      | 06    | N/A              |         |                  |     |                     | TBA*    |                      | N/A* |   |

\*-2 Sets Required. ■ - Also available in MX-S race compound, see page 8. ✖ - Oversize and Supermoto disc available - see page 301.

**SAFETY WARNING-** DO NOT USE HH PADS ON REAR UNLESS ALSO USED ON FRONT TO AVOID BRAKE IMBALANCE.

**R** Suffix = High Durability Sintered Pad. **HH** Suffix = High Performance Sintered Pad. **G** Suffix = Grooved Shoe.  
**D** Suffix = Drilled Disc. **C** Suffix = Contoured Disc. **LS** Suffix = Left/Steel Disc. **RS** = Right/Steel Disc.

**BRAKE APPLICATIONS**

# Non-Japanese Built Motorcycles/Quads



Front/Avant/Vorn



Frente/Anteriore

Rear/Arrière/Hinten



Posterior/Posteriore

1

2

3

4

5

6

7

8

9



Sintered/HH Pads/Grooved shoes



Contour Rotor Universal left and right fitment



Sintered/HH Pads/Grooved shoes



Contour Rotor Rear fitment

## ROXON contd.

|                            |       |      |  |  |  |  |        |       |     |
|----------------------------|-------|------|--|--|--|--|--------|-------|-----|
| Silver Fox 50 (Quad)       | 04-06 | TBA* |  |  |  |  | TBA    |       |     |
| Fox 100 (Quad)             | 04-06 | TBA* |  |  |  |  | TBA    |       |     |
| RX 150 (Quad)              | 04-06 | TBA* |  |  |  |  | FA83TT | FA83R | N/A |
| Sport Spirit NFS150 (Quad) | 04-06 | TBA* |  |  |  |  | FA83TT | FA83R | N/A |

## ROVIGO

|               |       |     |  |     |  |  |     |  |  |
|---------------|-------|-----|--|-----|--|--|-----|--|--|
| Spoletto 50cc | 04-05 | TBA |  | N/A |  |  | TBA |  |  |
| Tempesta 50cc | 04-05 | TBA |  | N/A |  |  | TBA |  |  |
| Tempesta 90cc | 04-05 | TBA |  | N/A |  |  | TBA |  |  |

## ROYAL ENFIELD

|                   |       |       |         |     |  |  |     |  |  |
|-------------------|-------|-------|---------|-----|--|--|-----|--|--|
| Bullet Electra X  | 05-06 | FA228 | FA228HH | TBA |  |  | N/A |  |  |
| Electra T         | 05-06 | FA228 | FA228HH | TBA |  |  | N/A |  |  |
| Electra Sportsman | 05-06 | FA228 | FA228HH | TBA |  |  | N/A |  |  |

## SACHS (HERCULES)

|   |       |        |         |     |     |  |       |         |     |
|---|-------|--------|---------|-----|-----|--|-------|---------|-----|
| Diff. older models with disc brake          |       | FA50   |         | N/A |     |  | N/A   |         |     |
| 49 EF 10*                                   | 07    | FA233  |         | TBA |     |  | TBA   |         |     |
| 50 KX 5                                     |       | FA50   |         | N/A |     |  | N/A   |         |     |
| 50 Supra Enduro                             |       | 922    |         |     |     |  | 922   |         |     |
| 50 Supra 4 GP                               |       | FA67/2 |         | N/A |     |  | N/A   |         |     |
| 50 Ultra, RS Ultra                          |       | FA50   |         | N/A |     |  | 921   |         |     |
| Madass 50 (2 stroke) (Hydraulic rear brake) | 04-05 | FA86   | FA86HH  | N/A |     |  | FA115 | FA115HH | N/A |
| Madass 50 (4 stroke mechanical rear brake)  | 04-05 | FA86   | FA86HH  | N/A |     |  | N/A   |         | N/A |
| Mad Ass 50                                  | 06-07 | FA86   | FA86HH  | N/A |     |  | FA54  | FA54HH  | N/A |
| 80 CV                                       |       | Y503   |         |     |     |  | Y503  |         |     |
| 80 Ultra, F Ultra, RS Ultra                 |       | FA50   |         | N/A |     |  | 921   |         |     |
| 80 Ultra Chopper                            |       | FA50   |         | N/A |     |  | 921   |         |     |
| 80 Ultra AC                                 |       | FA50   |         | N/A |     |  | 922   |         |     |
| 80 Ultra AC Chopper                         |       | FA50   |         | N/A |     |  | 922   |         |     |
| 80 XE 9                                     |       | FA50   |         | N/A |     |  |       |         |     |
| Madass 125                                  | 05    | FA86   | FA86HH  | N/A |     |  | FA86  | FA86HH  | N/A |
| Mad Ass 125                                 | 06-07 | FA86   | FA86HH  | N/A |     |  | FA54  | FA54HH  | N/A |
| Roadster 125 V2                             | 00-03 | FA167  | FA167HH | TBA |     |  | Y506  |         |     |
| 125 Roadster                                | 03-04 | TBA    |         | N/A |     |  | TBA   |         |     |
| X Road 125                                  | 06    | FA95   |         |     | N/A |  | FA382 |         | N/A |
| X Road 125                                  | 07    | FA95   | FA95HH  |     | N/A |  | FA54  | FA54HH  | N/A |
| XTC 125 Supersport                          | 00-07 | FA95   | FA95HH  |     | N/A |  | FA382 |         | N/A |
| ZX 125 'Enduro'                             | 01-02 | FA194  | FA194HH | N/A | N/A |  | FA382 |         | N/A |
| ZZ 125 'Funbike'                            | 02    | FA193  | FA193HH | N/A |     |  | FA382 |         | N/A |
| Roadster 650                                | 01-04 | FA95   | FA95HH  | N/A |     |  | FA382 |         | N/A |
| Roadster 650                                | 05    | FA95   | FA95HH  | N/A |     |  | FA101 |         | N/A |
| Roadster 800                                | 02-05 | FA95*  | FA95HH* | N/A | N/A |  | S626  |         |     |
| B-805                                       | 03-04 | FA95*  | FA95HH* | N/A | N/A |  | S626  |         |     |

## SCORPA

|                      |       |         |         |     |     |  |         |        |     |
|----------------------|-------|---------|---------|-----|-----|--|---------|--------|-----|
| 4 Tricks (70cc)      | 06    | CFA331  |         |     | N/A |  | CFA331  |        | N/A |
| SY 125 F Trials      | 03-06 | FA303   |         | N/A |     |  | FA351   |        | N/A |
| TY-S 125 F Enduro    | 03-05 | FA115TT | FA115R  | N/A |     |  | FA115TT | FA115R | N/A |
| TY-S 125 F           | 06-07 | FA115TT | FA115R  | N/A |     |  | FA351   |        | N/A |
| TY-S 125 F Long Ride | 06-07 | FA115TT | FA115R  | N/A |     |  | FA351   |        | N/A |
| TY-S 125 F Racing    | 07    | FA115TT | FA115R  | N/A |     |  | FA351   |        | N/A |
| SY 175 F             | 06    | FA303   |         | N/A |     |  | FA351   |        | N/A |
| TY-S 175 F           | 06    | FA115TT | FA115R  | N/A |     |  | FA351   |        | N/A |
| 250 Easy             | 96-99 | FA115TT | FA115R  | N/A |     |  | FA115TT | FA115R | N/A |
| SY 250               | 00-07 | FA303   |         | N/A |     |  | FA351   |        | N/A |
| SY 250 Long Ride     | 04-07 | FA303   |         | N/A |     |  | FA351   |        | N/A |
| SY 250 F             | 06-07 | FA303   |         | N/A |     |  | FA351   |        | N/A |
| Raidster 660         | 07    | FA244   | FA244HH | TBA |     |  | FA351   |        | TBA |

\*-2 Sets Required. ■ - Also available in MX-S race compound, see page 8. ✖ - Oversize and Supermoto disc available - see page 301.

**SAFETY WARNING-** DO NOT USE HH PADS ON REAR UNLESS ALSO USED ON FRONT TO AVOID BRAKE IMBALANCE.

# Non-Japanese Built Motorcycles/Quads



## SHERCO

|                      |       | Front/Avant/Vorn |                                |                   | Frente/Anteriore    |  | Rear/Arrière/Hinten |                                |     | Posterior/Posteriore       |  |
|----------------------|-------|------------------|--------------------------------|-------------------|---------------------|--|---------------------|--------------------------------|-----|----------------------------|--|
|                      |       | 1                | 2                              | 3                 | 4                   | 5  | 6                   | 7                              | 8   | 9                          |  |
|                      |       |                  | Sintered/HH Pads/Grooved shoes | Left/Gauche/Links | Right/Droite/Rechts | Contour Rotor Universal left and right fitment |                     | Sintered/HH Pads/Grooved shoes |     | Contour Rotor Rear fitment |  |
| 0.5 Trials           | 01-03 | TBA              |                                |                   |                     |  | TBA                 |                                |     |                            |  |
| (SM 50) Supermotard  | 03-07 | FA167            | FA167HH                        | N/A               |                     |  | FA115               | FA115HH                        | N/A |                            |  |
| Enduro 50 (50EN)     | 03-07 | FA167            | FA167HH                        | N/A               |                     |  | FA115               | FA115HH                        | N/A |                            |  |
| 0.8 Trials           | 01-05 | FA115            | FA115R                         | N/A               |                     |  | FA351               |                                | N/A |                            |  |
| Trials 0.8           | 06-07 | FA303            |                                | N/A               |                     |  | FA351               |                                | N/A |                            |  |
| SM 125/125 City Corp | 03-06 | FA167            | FA167HH                        | N/A               |                     |  | FA115               | FA115HH                        | N/A |                            |  |
| 1.25/200             | 01-05 | FA115            | FA115R                         | N/A               |                     |  | FA115               | FA115R                         | N/A |                            |  |
| 1.25                 | 06-07 | FA303            |                                | N/A               |                     |  | FA351               |                                | N/A |                            |  |
| Sherco 250           | 99-00 | FA115            | FA115R                         | N/A               |                     |  | FA115               | FA115R                         | N/A |                            |  |
| 2.50/2.90            | 01-07 | FA303            |                                | N/A               |                     |  | FA351               |                                | N/A |                            |  |
| 2.5i Enduro (4T)     | 06    | FA181TT          | FA181R                         | N/A               |                     |  | FA351               |                                | N/A |                            |  |
| 3.2 (320 4T)         | 05-07 | FA303            |                                | N/A               |                     |  | FA351               |                                | N/A |                            |  |
| 4.5i (450 Enduro/SM) | 04-07 | FA181TT          | FA181R                         | N/A               |                     |  | FA367TT             | FA367R                         | N/A |                            |  |
| 4.5i Enduro (4T)     | 06-07 | FA181TT          | FA181R                         | N/A               |                     |  | FA367TT             | FA367R                         | N/A |                            |  |
| 5.1i Enduro          | 06-07 | FA181TT          | FA181R                         | N/A               |                     |  | FA367TT             | FA367R                         | N/A |                            |  |
| 5.1i Supermoto       | 06-07 | FA181TT          | FA181R                         | N/A               |                     |  | FA367TT             | FA367R                         | N/A |                            |  |

## SIAMOTO

|               |       |         |         |     |  |  |       |         |     |  |
|---------------|-------|---------|---------|-----|--|--|-------|---------|-----|--|
| Birdie 50     | 02-04 | FA169   |         | TBA |  |  | TBA   |         |     |  |
| Mat 50        | 97-01 | TBA     |         | TBA |  |  | TBA   |         |     |  |
| Scross 50     | 97-01 | TBA     |         | TBA |  |  | TBA   |         |     |  |
| TR 50         |       | TBA     |         | TBA |  |  | TBA   |         |     |  |
| Mat 100       | 97-01 | TBA     |         | TBA |  |  | TBA   |         |     |  |
| Capri Quattro | 00-01 | TBA     |         | TBA |  |  | TBA   |         |     |  |
| Columbus 125  | 01-02 | TBA     |         | TBA |  |  | TBA   |         |     |  |
| KD 125        | 00-04 | FA101TT |         | TBA |  |  | TBA   |         |     |  |
| Favorite 125  | 02-04 | FA169   |         | TBA |  |  | TBA   |         |     |  |
| SX1 125       | 04    | FA194   | FA194HH | N/A |  |  | FA115 | FA115HH | N/A |  |
| Geco 250      | 04    | FA106TT |         | N/A |  |  | S602  |         |     |  |

## SUPERBYKE

|                        |       |       |         |         |     |  |      |        |       |  |
|------------------------|-------|-------|---------|---------|-----|--|------|--------|-------|--|
| Ape Byke 50            |       | TBA   |         |         |     |  | TBA  |        |       |  |
| CQ 50 Road Classic     |       | FA375 |         |         | N/A |  | FA86 |        | N/A   |  |
| M-Ped 50 Road Classic  |       | FA169 | FA169HH | MD904D  |     |  | TBA  |        |       |  |
| RFX 50 Road Trail      |       | FA93  |         | N/A     |     |  | TBA  |        |       |  |
| CU 125 Road Classic    |       | FA375 |         |         | N/A |  | FA86 |        | N/A   |  |
| M-Ped 125 Road Classic |       | FA86  | FA86HH  |         | N/A |  | TBA  |        |       |  |
| RFX 125 Road Trail     |       | FA93  |         | N/A     |     |  | TBA  |        |       |  |
| R-MX 125 4V            | 05-07 | TBA   |         | N/A     |     |  | TBA  |        |       |  |
| R-SR 125 4V            |       | FA56  |         |         | N/A |  | TBA  |        |       |  |
| SB 125-4               |       | TBA   |         |         |     |  | TBA  |        |       |  |
| RFX 200                | 05-07 | TBA   |         | N/A     |     |  | TBA  |        | N/A   |  |
| R-SR 250               |       | FA86  | FA86HH  | MD690LS |     |  | FA86 | FA86HH | MD689 |  |

## SVM (SWM)

|                                |     |      |        |     |  |  |  |       |  |  |
|--------------------------------|-----|------|--------|-----|--|--|--|-------|--|--|
| 50/80 TR/TL Trial              | -83 |      | 926WG  |     |  |  |  | 926WG |  |  |
| 50/80 MK/GS/RBS Enduro         | 83- |      | 841WG  |     |  |  |  | 841WG |  |  |
| 50/80 MK/MC Cross              | 83- |      | 841WG  |     |  |  |  | 841WG |  |  |
| 125/175/250/347/440 Enduro     | -83 |      | 843WG  |     |  |  |  | 843WG |  |  |
| 125/250/440 Cross              | -83 |      | 843WG  |     |  |  |  | 843WG |  |  |
| 125/240/320/350 HM/MW/TL Trial | -83 |      | 841WG  |     |  |  |  | 841WG |  |  |
| 125/250 S1/S2                  | 83- | FA47 | FA47R  | N/A |  |  |  | 841WG |  |  |
| 323 Trial                      | 85- |      | 841WG  |     |  |  |  | 841WG |  |  |
| Or                             |     | FA47 | FA47R  | N/A |  |  |  | 841WG |  |  |
| 350 XP Sahara                  | 83- | FA18 | FA18HH | N/A |  |  |  | 841WG |  |  |
| XN 506 Enduro                  | 84- |      | 843WG  |     |  |  |  | 843WG |  |  |

\*-2 Sets Required. ■ - Also available in MX-S race compound, see page 8. ✖ - Oversize and Supermoto disc available - see page 301.

**SAFETY WARNING-** DO NOT USE HH PADS ON REAR UNLESS ALSO USED ON FRONT TO AVOID BRAKE IMBALANCE.

**R** Suffix = High Durability Sintered Pad. **HH** Suffix = High Performance Sintered Pad. **G** Suffix = Grooved Shoe.  
**D** Suffix = Drilled Disc. **C** Suffix = Contoured Disc. **LS** Suffix = Left/Steel Disc. **RS** = Right/Steel Disc.

**BRAKE APPLICATIONS**

# Non-Japanese Built Motorcycles/Quads



Front/Avant/Vorn



Frente/Anteriore

Rear/Arrière/Hinten



Posterior/Posteriore

## SYM

|  |       | 1                              | 2                              | 3                 | 4                   | 5  | 6                              | 7                              | 8                          | 9                          |
|--|-------|--------------------------------|--------------------------------|-------------------|---------------------|--|--------------------------------|--------------------------------|----------------------------|----------------------------|
|  |       | Sintered/HH Pads/Grooved shoes | Sintered/HH Pads/Grooved shoes | Left/Gauche/Links | Right/Droite/Rechts | Contour Rotor Universal left and right fitment | Sintered/HH Pads/Grooved shoes | Sintered/HH Pads/Grooved shoes | Contour Rotor Rear fitment | Contour Rotor Rear fitment |
| Cinderella 50/100                            | 99-00 | FA151                          |                                | MDD933D           |                     |  | H303                           |                                |                            |                            |
| DD 50 City Trek                              | 02-06 | FA151                          |                                | N/A               |                     |  | H333                           |                                |                            |                            |
| Fiddle 50                                    | 99-05 | H303                           |                                |                   |                     |  | H302                           |                                |                            |                            |
| City Hopper 50                               | 99-02 | FA257                          |                                | MD933D            |                     |  | H303                           |                                |                            |                            |
| Shark 50                                     | 99-03 | FA306                          |                                | N/A               |                     |  | 820                            |                                |                            |                            |
| Super Fancy 50                               | 96-06 | FA257                          |                                | MD933D            |                     |  | H303                           |                                |                            |                            |
| Jet Basix 50                                 | 06-07 | FA264                          |                                | MD9116D           |                     |  | H303                           |                                |                            |                            |
| Jet 50/Euro X S                              | 99-05 | FA264                          |                                | MD9116D           |                     |  | H303                           |                                |                            |                            |
| Jet Euro X 50/100                            | 06-07 | FA264                          |                                | MD9116D           |                     |  | H303                           |                                |                            |                            |
| Jet Sport X 50 (R/S/SR)                      | 06-07 | FA264                          |                                | TBA               |                     |  | FA234                          |                                | TBA                        |                            |
| Jungle 50/100                                | 99-02 | FA264                          |                                | MD9116D           |                     |  | H303                           |                                |                            |                            |
| Mask 50                                      | 00-05 | FA264                          |                                | MD9116D           |                     |  | H303                           |                                |                            |                            |
| MIO 50/100                                   | 05-07 | FA151                          |                                | MD933D            |                     |  | H303                           |                                |                            |                            |
| Red Devil 50                                 | 99-05 | FA264                          |                                | MD9116D           |                     |  | H303                           |                                |                            |                            |
| RS 50  | 04-07 | FA306                          |                                | N/A               |                     |  | TBA                            |                                |                            |                            |
| Jet 100 (G100P-6)                            | 99-00 | FA264                          |                                | MD9116D           |                     |  | H303                           |                                |                            |                            |
| SR 100 Sunrise                               | 97    | FA131/2                        |                                | N/A               |                     |  |                                |                                |                            |                            |
| Attila 125                                   | 99-00 | FA264                          |                                | MD933D            |                     |  | H307                           |                                |                            |                            |
| CT 125                                       | 03-04 | FA297                          |                                |                   | N/A                 |  | 819                            |                                |                            |                            |
| Euro MX 125/150                              | 02-05 | FA306                          |                                | N/A               |                     |  | 820                            |                                |                            |                            |
| Euro MX 125                                  | 06    | FA306                          |                                | N/A               |                     |  | TBA                            |                                | TBA                        |                            |
| GTS 125/200 Voyager                          | 06-07 | FA427                          |                                | TBA               |                     |  | FA427                          |                                | TBA                        |                            |
| HD 125/200                                   | 04-07 | FA305                          |                                | N/A               |                     |  | 820                            |                                |                            |                            |
| HD 125 S Evo                                 | 07    | FA264                          |                                |                   |                     |  | 820                            |                                |                            |                            |
| Megalo 125                                   | 00-07 | FA264                          |                                | MD933D            |                     |  | 820                            |                                |                            |                            |
| Super Duke 125/150                           | 99-00 | FA264                          |                                | MD933D            |                     |  | H307                           |                                |                            |                            |
| Shark 125/150 (Drum rear model)              | 99-02 | FA306                          |                                | N/A               |                     |  | 820                            |                                |                            |                            |
| Shark 4VR 125/150 R (Rear disc model)        | 00-02 | FA306                          |                                | N/A               |                     |  | FA197                          |                                | N/A                        |                            |
| Huskey 125/150                               | 99-05 | FA297                          |                                | N/A               |                     |  | 819                            |                                |                            |                            |
| Joyride 125/150                              | 01-07 | FA306                          |                                | N/A               |                     |  | FA305                          |                                | N/A                        |                            |
| RS 125                                       | 04-06 | FA306                          |                                | N/A               |                     |  | TBA                            |                                |                            |                            |
| SK 125                                       | 03-04 | FA306                          |                                | N/A               |                     |  | FA305                          |                                | N/A                        |                            |
| Voyager 125                                  | 05    | FA196                          | FA196HH                        | N/A               |                     |  | FA196                          | FA196HH                        | N/A                        |                            |
| VS 125/150                                   | 06-07 | FA306                          |                                | N/A               |                     |  | 820                            |                                |                            |                            |
| RS 150                                       | 06    | FA306                          |                                | N/A               |                     |  | FA228                          |                                | N/A                        |                            |
| Wolf Legend                                  | 04-05 | FA86                           | FA86HH                         |                   | N/A                 |  | 819                            |                                |                            |                            |
| Wolf 125/150 Scooter (Type 125M/P125M/P150M) | 00    | H306                           |                                |                   |                     |  | H307                           |                                |                            |                            |
| H 200 SE                                     | 06    | FA264                          |                                | TBA               |                     |  | FA427                          |                                | TBA                        |                            |
| HD 200 S Evo                                 | 07    | FA264                          |                                | TBA               |                     |  | FA427                          |                                | TBA                        |                            |
| Joyride 200                                  | 03-07 | FA306                          |                                | N/A               |                     |  | FA305                          |                                | N/A                        |                            |
| Trackrunner 200 Quad                         | 05-07 | FA377*                         | FA377R*                        | N/A               | N/A                 |  | FA427                          | FA427R                         | N/A                        |                            |
| Joymax 250                                   | 06    | FA355*                         |                                | N/A               |                     |  | FA427                          |                                | N/A                        |                            |
| GTS 250 Joymax                               | 07    | FA283*                         | FA283HH*                       | TBA               |                     |  | FA427                          |                                | TBA                        |                            |
| Quadlander 250                               | 05-07 | FA377*                         | FA377R*                        | N/A               | N/A                 |  | FA427                          | FA427R                         | N/A                        |                            |
| Voyager 250                                  | 05    | FA355*                         |                                | N/A               |                     |  | FA319/2                        | FA319/2HH                      | N/A                        |                            |
| Citymax 300 Quad                             | 06    | FA377*                         | FA377R*                        | TBA               | TBA                 |  | FA427                          | FA427R                         | TBA                        |                            |
| Outlander 300 S                              | 07    | FA377*                         | FA377R*                        | TBA               | TBA                 |  | FA377                          | FA377R                         | TBA                        |                            |
| GT 500                                       | 04    | FA283*                         | FA283HH*                       | N/A               |                     |  | FA305                          |                                | N/A                        |                            |
| XP 500                                       | 04    | TBA                            |                                | N/A               |                     |  | TBA                            |                                | N/A                        |                            |
| Quadraider 600                               | 06    | FA54TT*                        | FA54R*■                        | TBA               | TBA                 |  | FA377                          | FA377R                         | TBA                        |                            |
| <b>TAISHAN (Project Quads)</b>               |       |                                |                                |                   |                     |  |                                |                                |                            |                            |
| Commuter 50                                  | 03-05 | S632                           |                                |                   |                     |  | H303                           |                                |                            |                            |
| XT 50  | 03-04 | FA54TT                         | FA54HH                         | N/A               |                     |  | TBA                            |                                |                            |                            |
| Sport 50 (Drum front)                        | 03-05 | S632                           |                                | N/A               |                     |  | H303                           |                                |                            |                            |
| Panther 50 Quad                              | 03-04 | FA54TT                         | FA54HH                         | N/A               |                     |  | TBA                            |                                |                            |                            |
| Desert Cat 100                               | 04-05 | TBA*                           |                                |                   |                     |  | TBA                            |                                | TBA                        |                            |
| Desert Cat Extreme 100                       | 04-05 | TBA*                           |                                |                   |                     |  | TBA                            |                                | TBA                        |                            |
| Hurricane 125 Quad                           | 04-05 | TBA*                           |                                |                   |                     |  | FA165TT                        | FA165R                         | N/A                        |                            |
| XT 125 Sport                                 | 04-05 | FA54TT                         | FA54HH                         | N/A               |                     |  | TBA                            |                                |                            |                            |

\*-2 Sets Required. ■ - Also available in MX-S race compound, see page 8. ✖ - Oversize and Supermoto disc available - see page 301.

**SAFETY WARNING-** DO NOT USE HH PADS ON REAR UNLESS ALSO USED ON FRONT TO AVOID BRAKE IMBALANCE.



# Non-Japanese Built Motorcycles/Quads



TAISHAN contd.

|   |       | Front/Avant/Vorn |                                |                   | Frente/Anteriore    |  | Rear/Arrière/Hinten |                                |         | Posterior/Posteriore       |  |
|---|-------|------------------|--------------------------------|-------------------|---------------------|--|---------------------|--------------------------------|---------|----------------------------|--|
|   |       | 1                | 2                              | 3                 | 4                   | 5  | 6                   | 7                              | 8       | 9                          |  |
|   |       |                  | Sintered/HH Pads/Grooved shoes | Left/Gauche/Links | Right/Droite/Rechts | Contour Rotor Universal left and right fitment |                     | Sintered/HH Pads/Grooved shoes |         | Contour Rotor Rear fitment |  |
| Explorer 150 Quad                         | 04-05 | TBA*             |                                |                   |                     |  | FA165TT             | FA165R                         | N/A     |                            |  |
| Tornado 200 Quad                          | 04    | TBA*             |                                |                   |                     |  | FA165TT             | FA165R                         | N/A     |                            |  |
| <b>TERRA MOTO</b>                         |       |                  |                                |                   |                     |  |                     |                                |         |                            |  |
| TDX 125 F                                 | 07    | FA169            | FA169HH                        | N/A               |                     |  | FA169               | FA169HH                        | N/A     |                            |  |
| TDX 125 F Krusha                          | 07    | FA169            | FA169HH                        | N/A               |                     |  | FA169               | FA169HH                        | N/A     |                            |  |
| TDX 125 F Street Rippa                    | 07    | FA169            | FA169HH                        | N/A               |                     |  | FA169               | FA169HH                        | N/A     |                            |  |
| <b>TGB</b>                                |       |                  |                                |                   |                     |  |                     |                                |         |                            |  |
| Delivery 50 Scooter (Up to E/F no 609099) | 04-06 | FA264            |                                | MD923D            |                     |  | 897                 |                                |         |                            |  |
| Delivery 50 (From F/E No 609100)          | 06-07 | FA83TT           | FA83HH                         | MD923D            |                     |  | 897                 |                                |         |                            |  |
| Trigger 50                                |       | FA83TT           | FA83HH                         | MD923             |                     |  | Y503                |                                |         |                            |  |
| Akros Tec (50)                            | 03-04 | FA264            |                                | TBA               |                     |  | TBA                 |                                |         |                            |  |
| High Wheel 50                             |       | FA83TT           | FA83HH                         | MD923             |                     |  | Y503                |                                |         |                            |  |
| Hornet 50/90 Quad                         | 04-05 | H338*            | H338G*                         |                   |                     |  | FA83TT              | FA83R                          | N/A     |                            |  |
| Key West 50                               | 06-07 | FA83TT           | FA83R                          | MD923D            |                     |  | 897                 |                                |         |                            |  |
| Platform (50/125/150)                     | 06    | FA264            |                                | TBA               |                     |  | TBA                 |                                |         |                            |  |
| R 50 X/507                                | 06-07 | FA93             |                                | MD9115D           |                     |  | FA83TT              |                                | MD9115D |                            |  |
| RS 50cc                                   | 06-07 | FA83TT           | FA83HH                         | MD923D            |                     |  | 897                 |                                |         |                            |  |
| Sunset 50                                 | 07    | FA83TT           | FA83HH                         | MD923D            |                     |  | 897                 |                                |         |                            |  |
| Double X (50)                             | 06    | FA83TT           | FA83HH                         | MD923D            |                     |  | 897                 |                                |         |                            |  |
| 101 (50/125/150)                          | 05-06 | FA264            |                                | N/A               |                     |  | Y503                |                                |         |                            |  |
| 101 S                                     | 04-06 | FA83TT           | FA83HH                         | MD9223D           |                     |  | 897                 |                                |         |                            |  |
| R9 125cc C                                | 06-07 | FA93             |                                | MD9115D           |                     |  | 820                 |                                |         |                            |  |
| Delivery (151cc)                          | 04-07 | FA93             |                                | MD9115D           |                     |  | 820                 |                                |         |                            |  |
| Sunset 150                                | 07    | FA83TT           | FA83HH                         | MD923D            |                     |  | 820                 |                                |         |                            |  |
| 202 Classic (49cc)                        | 03-04 | FA264            |                                | TBA               |                     |  | TBA                 |                                |         |                            |  |
| 203                                       | 05-06 | FA264            |                                | MD923D            |                     |  | TBA                 |                                |         |                            |  |
| 204 Classic (125cc)                       | 03-04 | FA83TT           | FA83HH                         | TBA               |                     |  | TBA                 |                                |         |                            |  |
| 250 Bladel/Congo ATV                      | 06-07 | FA67TT*          | FA67R*                         | N/A               | N/A                 |  | FA83TT              | FA83R                          | N/A     |                            |  |
| 302 Sport (49cc)                          | 03-04 | FA93             |                                | TBA               |                     |  | TBA                 |                                |         |                            |  |
| 303R Hawk/Laser 50                        | 04-07 | FA83TT           | FA83HH                         | MD923D            |                     |  | 897                 |                                |         |                            |  |
| 303R Hawk/Laser 125/150                   | 04-07 | FA93             |                                | MD9115D           |                     |  | 820                 |                                |         |                            |  |
| 304 Sport (125cc)                         | 03-04 | FA93             |                                | TBA               |                     |  | Y506                |                                |         |                            |  |
| F409 Cruise 50/125                        | 05-   | FA83TT           | FA83HH                         | MD923             |                     |  | Y503                |                                |         |                            |  |
| 309 RS 50                                 |       | FA83TT           | FA83HH                         | TBA               |                     |  | Y503                |                                |         |                            |  |
| 404 Executive                             | 03-04 | FA93             |                                | TBA               |                     |  | TBA                 |                                |         |                            |  |
| F409 (50/125/150)                         | 06    | FA93             |                                | TBA               |                     |  | Y503                |                                |         |                            |  |
| Outback 425 Quad                          | 07    | FA377*           | FA377R*                        | N/A               | N/A                 |  | FA377*              | FA377R*                        | N/A*    |                            |  |
| <b>THUMPSTAR</b>                          |       |                  |                                |                   |                     |  |                     |                                |         |                            |  |
| Thumpstar Junior 90cc                     | 04-06 | FA169            | FA169HH                        | N/A               |                     |  | FA169               | FA169HH                        | N/A     |                            |  |
| Thumpstar Supa 110cc                      | 04-06 | FA169            | FA169HH                        | N/A               |                     |  | FA169               | FA169HH                        | N/A     |                            |  |
| Thumpstar Expert 125                      | 06    | FA169            | FA169HH                        | N/A               |                     |  | FA169               | FA169HH                        | N/A     |                            |  |
| Thumpstar Pro 125                         | 05-06 | FA169            | FA169HH                        | N/A               |                     |  | FA169               | FA169HH                        | N/A     |                            |  |
| Thumpstar 125 Road Ripper                 | 06    | FA169            | FA169HH                        | N/A               |                     |  | FA169               | FA169HH                        | N/A     |                            |  |
| <b>T.M.</b>                               |       |                  |                                |                   |                     |  |                     |                                |         |                            |  |
| Junior 80/85/100 Cross (Small wheel)      | 02-04 | FA181TT          | FA181R■                        | N/A               |                     |  | FA208TT             | FA208R■                        | N/A     |                            |  |
| Junior 80/85/100                          | 05-07 | FA181TT          | FA181R■                        | N/A               |                     |  | FA131TT             | FA131R■                        | N/A     |                            |  |
| 80/85/100 (Big wheel)                     | 02-04 | FA181TT          | FA181R■                        | N/A               |                     |  | FA208TT             | FA208R■                        | N/A     |                            |  |
| 80 Enduro                                 | 96-00 | FA181TT          | FA181R■                        | N/A               |                     |  | FA208TT             | FA208R■                        | N/A     |                            |  |
| 80/85 Minicross/Junior                    | 96-00 | FA83TT           | FA83R                          | N/A               |                     |  | FA84/3TT            | FA84/3R                        | N/A     |                            |  |
| 80/85 Cross                               | 96-01 | FA181TT          | FA181R■                        | N/A               |                     |  | FA208TT             | FA208R■                        | N/A     |                            |  |
| 125 Cross                                 | 95-00 | FA181TT          | FA181R■                        | N/A               |                     |  | FA208TT             | FA208R■                        | N/A     |                            |  |
| Cross MX 125 (2T)                         | 01-07 | FA181TT          | FA181R■                        | N/A               |                     |  | FA131TT             | FA131R■                        | N/A     |                            |  |
| 125 Enduro                                | 95-00 | FA181TT          | FA181R■                        | N/A               |                     |  | FA208TT             | FA208R■                        | N/A     |                            |  |
| Enduro EN 125 (2T)                        | 01-07 | FA181TT          | FA181R■                        | N/A               |                     |  | FA131TT             | FA131R■                        | N/A     |                            |  |
| SMM 125 Black Dream (Rim brake)           | 04-07 | N/A              |                                | N/A               |                     |  | FA47                | FA47HH                         | N/A     |                            |  |
| SMR 125                                   | 05    | FA95             | FA95HH                         | N/A               |                     |  | FA131TT             | FA131R■                        | N/A     |                            |  |

\*-2 Sets Required. ■ - Also available in MX-S race compound, see page 8. ✖ - Oversize and Supermoto disc available - see page 301.

**SAFETY WARNING-** DO NOT USE HH PADS ON REAR UNLESS ALSO USED ON FRONT TO AVOID BRAKE IMBALANCE.

**R** Suffix = High Durability Sintered Pad. **HH** Suffix = High Performance Sintered Pad. **G** Suffix = Grooved Shoe.  
**D** Suffix = Drilled Disc. **C** Suffix = Contoured Disc. **LS** Suffix = Left/Steel Disc. **RS** = Right/Steel Disc.

**BRAKE APPLICATIONS**

# Non-Japanese Built Motorcycles/Quads



Front/Avant/Vorn



Frente/Anteriore

Rear/Arrière/Hinten



Posterior/Posteriore

1

2

3

4

5

6

7

8

9



Sintered/HH Pads/  
Grooved shoes

Left/Gauche/Links

Right/Droite/Rechts

Contour Rotor  
Universal left and  
right fitment



Sintered/HH Pads/  
Grooved shoes



Contour Rotor  
Rear fitment

T.M. contd.

|                                   |       |         |           |     |  |  |         |         |     |  |
|-----------------------------------|-------|---------|-----------|-----|--|--|---------|---------|-----|--|
| 250 Cross                         | 95-00 | FA181TT | FA181R■   | N/A |  |  | FA208TT | FA208R■ | N/A |  |
| Cross MX 250 (2T)                 | 01-07 | FA181TT | FA181R■   | N/A |  |  | FA131TT | FA131R■ | N/A |  |
| 250 Enduro                        | 95-00 | FA181TT | FA181R■   | N/A |  |  | FA208TT | FA208R■ | N/A |  |
| EN 250 F (4T) Enduro              | 04-07 | FA181TT | FA181R■   | N/A |  |  | FA131TT | FA131R■ | N/A |  |
| Enduro EN 250 (2T)                | 01-07 | FA181TT | FA181R■   | N/A |  |  | FA131TT | FA131R■ | N/A |  |
| SME 250 (4T)                      | 04-   | FA95    | FA95HH    | N/A |  |  | FA131TT | FA131R■ | N/A |  |
| 250 (4T) Cross                    | 02-07 | FA181TT | FA181R■   | N/A |  |  | FA131TT | FA131R■ | N/A |  |
| SM 250                            | 02    | FA95    | FA95HH    | N/A |  |  | FA131TT | FA131R■ | N/A |  |
| 300 Cross                         | 95-00 | FA181TT | FA181R■   | N/A |  |  | FA208TT | FA208R■ | N/A |  |
| 300 Enduro (2T)                   | 95-00 | FA181TT | FA181R■   | N/A |  |  | FA208TT | FA208R■ | N/A |  |
| Cross MX 300 (2T)                 | 01-07 | FA181TT | FA181R■   | N/A |  |  | FA131TT | FA131R■ | N/A |  |
| Enduro EN 300 (2T)                | 01-07 | FA181TT | FA181R■   | N/A |  |  | FA131TT | FA131R■ | N/A |  |
| 400 (4T) MX Cross                 | 02-03 | FA181TT | FA181R■   | N/A |  |  | FA131TT | FA131R■ | N/A |  |
| 400 Cross (4T)                    | 95-00 | FA181TT | FA181R■   | N/A |  |  | FA208TT | FA208R■ | N/A |  |
| SME 400 (4T)                      | 04-   | FA95    | FA95HH    | N/A |  |  | FA131TT | FA131R■ | N/A |  |
| SMM 400 (4T) (Rim brake)          | 04-   | N/A     |           | N/A |  |  | FA47    | FA47HH  | N/A |  |
| SM 400                            | 02-03 | FA95    | FA95HH    | N/A |  |  | FA131TT | FA131R■ | N/A |  |
| EN 450 F (4T)                     | 04-07 | FA181TT | FA181R■   | N/A |  |  | FA131TT | FA131R■ | N/A |  |
| MX 450 F (4T)                     | 04-07 | FA181TT | FA181R■   | N/A |  |  | FA131TT | FA131R■ | N/A |  |
| SMR 450 FES                       | 05-07 | FA95    | FA95HH    | N/A |  |  | FA131TT | FA131R■ | N/A |  |
| SMX 450 F                         | 05-07 |         | FA322/4HH | N/A |  |  | FA131TT | FA131R■ | N/A |  |
| 530 Cross (4T)                    | 98-00 | FA181TT | FA181R■   | N/A |  |  | FA208TT | FA208R■ | N/A |  |
| EN 530 F (4T)                     | 04-07 | FA181TT | FA181R■   | N/A |  |  | FA131TT | FA131R■ | N/A |  |
| SMM 530 F Black Dream (Rim brake) | 04-07 | N/A     |           | N/A |  |  | FA47    | FA47HH  | N/A |  |
| SM 530                            | 02-03 | FA95    | FA95HH    | N/A |  |  | FA131TT | FA131R■ | N/A |  |
| SME 530 (4T)                      | 04-   | FA95    | FA95HH    | N/A |  |  | FA131TT | FA131R■ | N/A |  |
| SMR 530 F ES                      | 05-07 | FA95    | FA95HH    | N/A |  |  | FA131TT | FA131R■ | N/A |  |
| SMX 530 F                         | 05-07 |         | FA322/4HH | N/A |  |  | FA131TT | FA131R■ | N/A |  |
| 530 (4T) Cross                    | 02-03 | FA95    | FA95HH    | N/A |  |  | FA131TT | FA131R■ | N/A |  |
| SMX 660 F                         | 04-   | FA95    | FA95HH    | N/A |  |  | FA131TT | FA131R■ | N/A |  |
| SMX 660 F                         | 05-07 |         | FA322/4HH | N/A |  |  | FA131TT | FA131R■ | N/A |  |

## TOMOS

|                         |       |         |         |     |  |  |         |         |     |  |
|-------------------------|-------|---------|---------|-----|--|--|---------|---------|-----|--|
| Moped with spoke wheels |       | 908     |         |     |  |  | 908     |         |     |  |
| Moped with cast wheels  |       | 931     |         |     |  |  | 931     |         |     |  |
| Streetmate              | 03-04 | FA116   |         | N/A |  |  | TBA     |         |     |  |
| Streetmate              | 05    | FA115   | FA115HH | N/A |  |  | TBA     |         |     |  |
| Revival/Revival TS      | 03-04 | FA116   |         | N/A |  |  | TBA     |         |     |  |
| MC 36                   | 05-07 | TBA     |         |     |  |  | TBA     |         |     |  |
| MC 50 Junior            | 05-07 | TBA     |         |     |  |  | TBA     |         |     |  |
| MC 50 Senior            | 05    | FA325TT | FA325R  | N/A |  |  | FA325TT | FA325R  | N/A |  |
| MC 50 Senior            | 05-07 | TBA     |         |     |  |  | TBA     |         |     |  |
| MC 50 Senior Pro        | 05-07 | FA351   |         | N/A |  |  | FA351   |         | N/A |  |
| Youngst'r               | 05    | FA115   | FA115HH | N/A |  |  | TBA     |         |     |  |
| SE 50/125               | 05    | FA167   | FA167HH | N/A |  |  | FA115   | FA115HH | N/A |  |
| MC 80                   | 05-07 | TBA     |         |     |  |  | TBA     |         |     |  |
| SM 125                  | 05    | FA266   | FA266HH | N/A |  |  | FA115   | FA115HH | N/A |  |

## TRIUMPH

|   |       |       |         |          |  |  |         |           |       |  |
|---|-------|-------|---------|----------|--|--|---------|-----------|-------|--|
| Adventurer                                  | 96-01 | FA196 | FA196HH | MD642LS  |  |  | FA196   | FA196HH   | MD643 |  |
| America (Cast wheel)                        | 07    | FA196 | FA196HH | MD649LS⓪ |  |  | FA214/2 | FA214/2HH | MD643 |  |
| T 120 (650cc) Twin leading shoe             | 66-70 | 853   |         |          |  |  | 854     |           |       |  |
| T 150 Twin leading shoe                     | 69-70 | 853   |         |          |  |  | 854     |           |       |  |
| Cub 500                                     |       | 858   |         |          |  |  | 858     |           |       |  |
| Bonneville (750 Twin)<br>(Lockheed caliper) | -84   | FA16  | FA16HH  | N/A      |  |  | FA16    | FA16HH    | N/A   |  |
| Bonneville (750 Twin)<br>(Brembo caliper)   | 85-86 | FA18  | FA18HH  | N/A      |  |  | FA18    | FA18HH    | N/A   |  |
| Bonneville America (Spoke wheel)            | 02-06 | FA196 | FA196HH | MD649LS⓪ |  |  | FA214/2 | FA214/2HH | MD643 |  |

Floating conversion available order MD601LS/RS

\*-2 Sets Required. ■ - Also available in MX-S race compound, see page 8. ✖ - Oversize and Supermoto disc available - see page 301.

**SAFETY WARNING-** DO NOT USE HH PADS ON REAR UNLESS ALSO USED ON FRONT TO AVOID BRAKE IMBALANCE.

# Non-Japanese Built Motorcycles/Quads



TRIUMPH contd.

|  |       | Front/Avant/Vorn                   |                   |                     | Frente/Anteriore                                     |         | Rear/Arrière/Hinten                |           |                               | Posterior/Posteriore |  |
|--|-------|------------------------------------|-------------------|---------------------|--|---------|------------------------------------|-----------|-------------------------------|----------------------|--|
|  |       | 1                                  | 2                 | 3                   | 4  | 5       | 6                                  | 7         | 8                             | 9                    |  |
|  |       | Sintered/HH Pads/<br>Grooved shoes | Left/Gauche/Links | Right/Droite/Rechts | Contour Rotor<br>Universal left and<br>right fitment |         | Sintered/HH Pads/<br>Grooved shoes |           | Contour Rotor<br>Rear fitment |                      |  |
| Bonneville 800 (790cc)   | 01-06 | FA196                              | FA196HH           | MD649LS①            |  |         | FA214/2                            | FA214/2HH | MD663                         |                      |  |
| Floating conversion available order MD601LS/RS   |       |                                    |                   |                     |  |         |                                    |           |                               |                      |  |
| Bonneville T100 (790cc)  | 02-04 | FA196                              | FA196HH           | MD649LS①            |  |         | FA214/2                            | FA214/2HH | MD663                         |                      |  |
| Floating conversion available order MD601LS/RS   |       |                                    |                   |                     |  |         |                                    |           |                               |                      |  |
| Bonneville T100 (865cc)  | 06-07 | FA196                              | FA196HH           | MD649LS①            |  |         | FA214/2                            | FA214/2HH | MD663                         |                      |  |
| Floating conversion available order MD601LS/RS   |       |                                    |                   |                     |  |         |                                    |           |                               |                      |  |
| Bonneville/Bonneville Black (865cc)  | 07    | FA196                              | FA196HH           | MD649LS①            |  |         | FA214/2                            | FA214/2HH | MD663                         |                      |  |
| Daytona 600  | 03-04 | FA236*                             | FA236HH*          | MD662LS             | MD662RS  | MD662C* | FA140                              | FA140HH   | MD648                         | MD648C               |  |
| TT 600   | 00-03 | FA236*                             | FA236HH*          | MD662LS             | MD662RS  | MD662C* | FA140                              | FA140HH   | MD648                         | MD648C               |  |
| Daytona 650  | 05    | FA236*                             | FA236HH*          | MD662LS             | MD662RS  | MD662C* | FA214/2                            | FA214/2HH | MD648                         | MD648C               |  |
| Daytona 675  | 06-07 |                                    | FA347HH*          | MD662LS             | MD662RS  | MD662C* | FA140                              | FA140HH   | MD648                         | MD648C               |  |
| T595 Daytona (6 bolt) front disc   | 97    | FA236*                             | FA236HH*          | MD647LS             | MD647RS  | MD647C* | FA214/2                            | FA214/2HH | MD648                         | MD648C               |  |
| Daytona 955i (6 bolt) (single sided<br>swinging arm) front disc  | 98-00 | FA236*                             | FA236HH*          | MD647LS             | MD647RS  | MD647C* | FA214/2                            | FA214/2HH | MD648                         | MD648C               |  |
| Daytona 955i (from VIN132513) (5 bolt)<br>(double sided s/arm & single sided<br>s/arm) front disc  | 01-04 | FA236*                             | FA236HH*          | MD669LS             | MD669RS  | MD669C* | FA140                              | FA140HH   | MD648                         | MD648C               |  |
| Daytona 750 (3 cyl)  | 92    | FA236*                             | FA236HH*          | MD640LS             | MD640RS  |         | FA215/2                            | FA215/2HH | MD641                         |                      |  |
| Daytona 1000 (4 cyl)   | 92    | FA236*                             | FA236HH*          | MD640LS             | MD640RS  |         | FA215/2                            | FA215/2HH | MD641                         |                      |  |
| Daytona 900 (3 cyl)  | 93-96 | FA236*                             | FA236HH*          | MD640LS             | MD640RS  |         | FA215/2                            | FA215/2HH | MD641                         |                      |  |
| Daytona 955i   | 05-06 | FA236*                             | FA236HH*          | MD669LS             | MD669RS  | MD669C* | FA214/2                            | FA214/2HH | MD648                         | MD648C               |  |
| Daytona Super III (3 cyl)  | 94-97 | FA190*                             | FA190HH*          | MD640LS             | MD640RS  |         | FA215/2                            | FA215/2HH | MD641                         |                      |  |
| Daytona 1200 (4 cyl)   | 93-98 | FA236*                             | FA236HH*          | MD640LS             | MD640RS  |         | FA215/2                            | FA215/2HH | MD641                         |                      |  |
| Legend TT  | 98-01 | FA196                              | FA196HH           | MD642LS             |  |         | FA196                              | FA196HH   | MD643                         |                      |  |
| Rocket III 2300cc  | 04-07 | FA236*                             | FA236HH*          | MD669LS             | MD669RS  | MD669C* | FA209/2                            | FA209/2HH | TBA                           |                      |  |
| Rocket III Classic   | 07    | FA236*                             | FA236HH*          | MD669LS             | MD669RS  | MD669C* | FA209/2                            | FA209/2HH | TBA                           |                      |  |
| Scrambler (865cc)  | 06-07 | FA196                              | FA196HH           | MD649LS①            |  |         | FA214/2                            | FA214/2HH | MD663                         |                      |  |
| Speed Triple (carb models)   | 94-97 | FA236*                             | FA236HH*          | MD640LS             | MD640RS  |         | FA215/2                            | FA215/2HH | MD641                         |                      |  |
| Speed Triple (EFI) T509 - 885cc & 955cc<br>(up to VIN 141871) (6 bolt front disc)  | 97-01 | FA236*                             | FA236HH*          | MD647LS             | MD647RS  | MD647C* | FA214/2                            | FA214/2HH | MD648                         | MD648C               |  |
| Speedtriple 955cc (from VIN 141872)<br>(5 bolt front disc)   | 02-04 | FA236*                             | FA236HH*          | MD669LS             | MD669RS  | MD669C* | FA214/2                            | FA214/2HH | MD648                         | MD648C               |  |
| Speed Triple (1050cc) Radial caliper   | 06-07 |                                    | FA347HH*          | MD679LS             | MD679LS  |         | FA214/2                            | FA214/2HH | MD648                         |                      |  |
| Speedfour 600  | 02-05 | FA236*                             | FA236HH*          | MD662LS             | MD662RS  | MD662C* | FA140                              | FA140HH   | MD648                         | MD648C               |  |
| Speedmaster 800 (790cc)  | 03-04 | FA196                              | FA196HH           | MD649LS①            | MD649RS①   |         | FA214/2                            | FA214/2HH | MD643                         |                      |  |
| Floating conversion available order MD601LS/RS   |       |                                    |                   |                     |  |         |                                    |           |                               |                      |  |
| Speedmaster (865cc)  | 05-07 | FA196*                             | FA196HH*          | MD649LS①            | MD649RS①   |         | FA214/2                            | FA214/2HH | MD643                         |                      |  |
| Floating conversion available order MD601LS/RS   |       |                                    |                   |                     |  |         |                                    |           |                               |                      |  |
| Sprint (All carb models) Left  | 93    | FA214                              | FA214HH           | MD646LS             |  |         | FA215/2                            | FA215/2HH | MD641                         |                      |  |
| Up to VIN 9082 Right   |       | FA215                              | FA215HH           |                     | MD646RS  |         |                                    |           |                               |                      |  |
| Sprint (All carb models from VIN 9083)   | 94-98 | FA236*                             | FA236HH*          | MD640LS             | MD640RS  |         | FA215/2                            | FA215/2HH | MD641                         |                      |  |
| Sprint RS (up to VIN 139276)<br>(6 bolt front disc)  |       |                                    |                   |                     |  |         |                                    |           |                               |                      |  |
| (double sided swinging arm)  | 99-01 | FA236*                             | FA236HH*          | MD647LS             | MD647RS  | MD647C* | FA215/2                            | FA215/2HH | MD663                         |                      |  |
| Sprint RS (from VIN 139277)<br>(6 bolt front disc) Note: up to<br>VIN 161317 double sided<br>swinging arm  | 02    | FA236*                             | FA236HH*          | MD647LS             | MD647RS  | MD647C* | FA215/2                            | FA215/2HH | MD663                         |                      |  |
| Sprint RS (from VIN 139277) (Single<br>sided swing arm up to VIN 161317)<br>(6 bolt front disc) Note: from VIN 161318<br>double sided swinging arm | 03-04 | FA236*                             | FA236HH*          | MD647LS             | MD647RS  | MD647C* | FA214/2                            | FA214/2HH | MD663                         |                      |  |
| Sprint ST (up to VIN 139276)<br>(6 bolt front disc)  |       |                                    |                   |                     |  |         |                                    |           |                               |                      |  |
| Single sided swing arm   | 99-01 | FA236*                             | FA236HH*          | MD647LS             | MD647RS  | MD647C* | FA214/2                            | FA214/2HH | MD663                         |                      |  |
| Sprint ST (from VIN 139277 to 208166)<br>(6 bolt front disc)   |       |                                    |                   |                     |  |         |                                    |           |                               |                      |  |
| Single sided swing arm   | 02-04 | FA236*                             | FA236HH*          | MD647LS             | MD647RS  | MD647C* | FA214/2                            | FA214/2HH | MD663                         |                      |  |
| Sprint ST (1050cc) (from VIN 208167)   | 05-07 | FA236*                             | FA236HH*          | MD669LS             | MD669RS  | MD669C* | FA214/2                            | FA214/2HH | MD663                         |                      |  |
| Thunderbird  | 95-03 | FA196                              | FA196HH           | MD642LS             |  |         | FA196                              | FA196HH   | MD643                         |                      |  |

\*-2 Sets Required. ■ - Also available in MX-S race compound, see page 8. ✖ - Oversize and Supermoto disc available - see page 301.

**SAFETY WARNING-** DO NOT USE HH PADS ON REAR UNLESS ALSO USED ON FRONT TO AVOID BRAKE IMBALANCE.

R Suffix = High Durability Sintered Pad. HH Suffix = High Performance Sintered Pad. G Suffix = Grooved Shoe.  
D Suffix = Drilled Disc. C Suffix = Contoured Disc. LS Suffix = Left/Steel Disc. RS = Right/Steel Disc.

BRAKE  
APPLICATIONS

# Non-Japanese Built Motorcycles/Quads



Front/Avant/Vorn



Frente/Anteriore

Rear/Arrière/Hinten



Posterior/Posteriore

1

2

3

4

5

6

7

8

9

## TRIUMPH contd.

|  |       |       | 1                                  | 2                                  | 3                 | 4                   | 5  | 6                                  | 7                                  | 8                             | 9 |
|--|-------|-------|------------------------------------|------------------------------------|-------------------|---------------------|--|------------------------------------|------------------------------------|-------------------------------|---|
|  |       |       | Sintered/HH Pads/<br>Grooved shoes | Sintered/HH Pads/<br>Grooved shoes | Left/Gauche/Links | Right/Droite/Rechts | Contour Rotor<br>Universal left and<br>right fitment | Sintered/HH Pads/<br>Grooved shoes | Sintered/HH Pads/<br>Grooved shoes | Contour Rotor<br>Rear fitment |   |
| Thunderbird Sport  | 98-04 |       | FA196*                             | FA196HH*                           | MD649LS①          | MD649RS①            |  | FA196                              | FA196HH                            | MD643                         |   |
| Floating conversion available order MD601LS/RS                           |       |       |                                    |                                    |                   |                     |  |                                    |                                    |                               |   |
| Tiger 885cc (Carbs) (Up to VIN 71698)                                    | Left  | 92-97 | FA214                              | FA214HH                            | MD644LS           |                     |  | FA215/2                            | FA215/2HH                          | MD645                         |   |
|  | Right |       | FA215                              | FA215HH                            |                   | MD644RS             |  |                                    |                                    |                               |   |
| Tiger 855i (From VIN 71699)  |       | 98-99 | FA196*                             | FA196HH*                           | MD649LS①          | MD649RS①            |  | FA196                              | FA196HH                            | MD643                         |   |
| Tiger 955cc (Spoke wheel) up to VIN 198874                               |       | 00-04 | FA196*                             | FA196HH*                           | MD649LS①          | MD649RS①            |  | FA196                              | FA196HH                            | MD643                         |   |
| Floating conversion available order MD601LS/RS                           |       |       |                                    |                                    |                   |                     |  |                                    |                                    |                               |   |
| Tiger 955 (Cast wheel) from VIN 198875                                   |       | 04-06 | FA196*                             | FA196HH*                           | MD676LS           | MD676RS             |  | FA215/2                            | FA215/2HH                          | MD677                         |   |
| Trident 750  | Left  | 92-98 | FA214                              | FA214HH                            | MD646LS           |                     |  | FA215/2                            | FA215/2HH                          | MD641                         |   |
|  | Right |       | FA215                              | FA215HH                            |                   | MD646RS             |  |                                    |                                    |                               |   |
| Thrupton 900   |       | 04-07 | FA142                              | FA142HH                            | MD629LS           |                     |  | FA214/2                            | FA214/2HH                          | MD663                         |   |
| Trident 900  | Left  | 92-98 | FA214                              | FA214HH                            | MD646LS           |                     |  | FA215/2                            | FA215/2HH                          | MD641                         |   |
|  | Right |       | FA215                              | FA215HH                            |                   | MD646RS             |  |                                    |                                    |                               |   |
| Trophy 900 (3 cyl)   | Left  | 92-93 | FA214                              | FA214HH                            | MD646LS           |                     |  | FA215/2                            | FA215/2HH                          | MD641                         |   |
| (up to VIN 9082)   | Right |       | FA215                              | FA215HH                            |                   | MD646RS             |  |                                    |                                    |                               |   |
| Trophy 900 (3 cyl) From VIN 9083   |       | 94-01 | FA236*                             | FA236HH*                           | MD640LS           | MD640RS             |  | FA215/2                            | FA215/2HH                          | MD641                         |   |
| Tiger 1050 (Radial caliper)  |       | 07    |                                    | FA347HH*                           | MD679LS           | MD679RS             |  | FA214/2                            | FA214/2HH                          | MD663                         |   |
| Trophy 1200 (4 cyl)  | Left  | 92-93 | FA214                              | FA214HH                            | MD646LS           |                     |  | FA215/2                            | FA215/2HH                          | MD641                         |   |
| (up to VIN 4901)   | Right |       | FA215                              | FA215HH                            |                   | MD646RS             |  |                                    |                                    |                               |   |
| Trophy 1200 (4 cyl) From VIN 4902  |       | 94-01 | FA236*                             | FA236HH*                           | MD640LS           | MD640RS             |  | FA215/2                            | FA215/2HH                          | MD641                         |   |
| NOTE ① MD601LS/RS Floating conversion in place of solid MD649LS/RS disc. |       |       |                                    |                                    |                   |                     |  |                                    |                                    |                               |   |
| <b>VECTRIX</b>   |       |       |                                    |                                    |                   |                     |  |                                    |                                    |                               |   |
| Vectrix Electric Std Scooter   |       | 07    | FA181TT                            | FA181HH                            |                   | TBA                 |  | FA181                              | FA181HH                            | TBA                           |   |
| Vectrix Electric 3W (MP3 style scooter)                                  |       | 07    | FA115*                             | FA115HH*                           | TBA               | TBA                 |  | FA181                              | FA181HH                            | TBA                           |   |
| <b>VERTEMATI</b>   |       |       |                                    |                                    |                   |                     |  |                                    |                                    |                               |   |
| All models with 2 piston Brembo calipers                                 |       | 99-04 | FA181TT                            | FA181R■                            | N/A               |                     |  | FA208TT                            | FA208R■                            | N/A                           |   |
| All models with 4 piston Beringher/Ergal calipers                        |       | 99-04 | FA158                              | FA158HH                            | N/A               |                     |  | FA208TT                            | FA208R■                            | N/A                           |   |
| <b>VESPA</b>   |       |       |                                    |                                    |                   |                     |  |                                    |                                    |                               |   |
| Vespa 50 "R"   |       | 70-83 | V905                               |                                    |                   |                     |  | V906                               |                                    |                               |   |
| Vespa 50 "S"   |       | 75-83 | V905                               |                                    |                   |                     |  | V904                               |                                    |                               |   |
| Vespa 50 Special Edition   |       | 91    | V905                               |                                    |                   |                     |  | V906                               |                                    |                               |   |
| Vespa 50 S   |       | 68    | V905                               |                                    |                   |                     |  | V906                               |                                    |                               |   |
| LX 50 (2T & 4T)  |       | 05-07 | FA260                              | FA260HH                            | MD910D            |                     |  | 899                                |                                    |                               |   |
| LXV 50   |       | 07    | FA260                              | FA260HH                            | MD956D            |                     |  | 899                                |                                    |                               |   |
| Vespa PK 50  |       | 82-85 | V905                               |                                    |                   |                     |  | V903                               |                                    |                               |   |
| Vespa PK 50 S  |       | 82-85 | V905                               |                                    |                   |                     |  | V903                               |                                    |                               |   |
| Vespa PK 50 SS   |       | 83-85 | V905                               |                                    |                   |                     |  | V903                               |                                    |                               |   |
| Vespa PK 50 S Automatica   |       | 84-89 | V905                               |                                    |                   |                     |  | V942                               |                                    |                               |   |
| Vespa PK 50 XL   |       | 85-88 | V905                               |                                    |                   |                     |  | V903                               |                                    |                               |   |
| Vespa PK 50 XL   |       | 88-89 | V903                               |                                    |                   |                     |  | V903                               |                                    |                               |   |
| Vespa 50 N   |       | 89-90 | V903                               |                                    |                   |                     |  | V903                               |                                    |                               |   |
| Vespa FL 50  |       | 90    | V903                               |                                    |                   |                     |  | V903                               |                                    |                               |   |
| Vespa FL2 Automatica   |       | 90-91 | V903                               |                                    |                   |                     |  | V942                               |                                    |                               |   |
| Vespa ET2 50   |       | 97-05 | FA260                              | FA260HH                            | MD910D            |                     |  | 899                                |                                    |                               |   |
| Vespa ET4 50 (Grimeca Caliper)   |       | 00-04 | FA260                              | FA260HH                            | MD910D            |                     |  | 899                                |                                    |                               |   |
| Vespa ET4 50 (Heng Tong Caliper)   |       | 00-04 | FA260                              | FA260HH                            | MD910D            |                     |  | 899                                |                                    |                               |   |
| LX 60 (Special Anniversary Model)  |       | 06    | FA186                              |                                    | MD910D            |                     |  | V903                               |                                    |                               |   |
| Vespa PK 100 XL  |       | 78-83 | V905                               |                                    |                   |                     |  | V906                               |                                    |                               |   |
| GT 125 Granturismo (Grimeca caliper)                                     |       | 03-06 | FA194                              | FA194HH                            | MD956D            |                     |  | FA321                              |                                    | MD956D                        |   |
| GT 125 Granturismo (Heng Tong caliper)                                   |       | 03-06 | FA353                              |                                    | MD956D            |                     |  | FA321                              |                                    | MD956D                        |   |
| GTV 125  |       | 07    | FA353                              |                                    | MD956D            |                     |  | FA321                              |                                    | MD956D                        |   |
| LXV 125  |       | 07    | FA260                              | FA260HH                            | MD956D            |                     |  | 899                                |                                    |                               |   |
| Vespa ET4 125  |       | 96-99 | FA260                              | FA260HH                            | MD910D            |                     |  | 899                                |                                    |                               |   |
| Vespa PX 125/150/200   |       | 98-07 | FA186                              |                                    |                   | MD910D              |  | V903                               |                                    |                               |   |
| Vespa ET4 125/150  |       | 99-05 | FA260                              | FA260HH                            | MD910D            |                     |  | 899                                |                                    |                               |   |
| Vespa 125 Primavera  |       | 67-83 | V905                               |                                    |                   |                     |  | V904                               |                                    |                               |   |

\*-2 Sets Required. ■ - Also available in MX-S race compound, see page 8. ✖ - Oversize and Supermoto disc available - see page 301.

**SAFETY WARNING-** DO NOT USE HH PADS ON REAR UNLESS ALSO USED ON FRONT TO AVOID BRAKE IMBALANCE.

# Non-Japanese Built Motorcycles/Quads



## VESPA contd.

|   |       | Front/Avant/Vorn |                                |                   | Frente/Anteriore    |  | Rear/Arrière/Hinten |                                |        | Posterior/Posteriore       |  |
|---|-------|------------------|--------------------------------|-------------------|---------------------|--|---------------------|--------------------------------|--------|----------------------------|--|
|   |       | 1                | 2                              | 3                 | 4                   | 5  | 6                   | 7                              | 8      | 9                          |  |
|   |       |                  | Sintered/HH Pads/Grooved shoes | Left/Gauche/Links | Right/Droite/Rechts | Contour Rotor Universal left and right fitment |                     | Sintered/HH Pads/Grooved shoes |        | Contour Rotor Rear fitment |  |
| Vespa 125 ET3                               | 76-83 | V905             |                                |                   |                     |  | V904                |                                |        |                            |  |
| LX 125/150 (4T)                             | 05-07 | FA260            | FA260HH                        | MD910D            |                     |  | 899                 |                                |        |                            |  |
| Vespa PX 125 E/EFL                          | 81-97 | V903             |                                |                   |                     |  | V903                |                                |        |                            |  |
| Vespa PK 125                                | 82-85 | V903             |                                |                   |                     |  | V903                |                                |        |                            |  |
| Vespa PK 125 S                              | 82-85 | V903             |                                |                   |                     |  | V903                |                                |        |                            |  |
| Vespa PK 125 S Automatica                   | 84-89 | V903             |                                |                   |                     |  | V942                |                                |        |                            |  |
| Vespa PX 125 T5                             | 85-00 | V903             |                                |                   |                     |  | V903                |                                |        |                            |  |
| Vespa FL 125                                | 89-00 | V903             |                                |                   |                     |  | V903                |                                |        |                            |  |
| Vespa PX 150 E/EFL                          | 81-97 | V903             |                                |                   |                     |  | V903                |                                |        |                            |  |
| GT 200 L Granturismo (Grimeca Caliper)      | 03-06 | FA194            | FA194HH                        | MD956D            |                     |  | FA321               |                                | MD956D |                            |  |
| GT 200 L Granturismo (Heng Tong Caliper)    | 03-06 | FA353            |                                | MD956D            |                     |  | FA321               |                                | MD956D |                            |  |
| Vespa PX 200 E/EFL                          | 81-97 | V903             |                                |                   |                     |  | V903                |                                |        |                            |  |
| GTS 250 ie/ABS                              | 05-07 | FA353            |                                | MD956D            |                     |  | FA321               |                                | MD956D |                            |  |
| GT 60 (Special Anniversary Model) (GTV 250) | 06    | FA353            |                                | MD956D            |                     |  | FA321               |                                | MD956D |                            |  |
| GTV 250 ie                                  | 07    | FA353            |                                | MD956D            |                     |  | FA321               |                                | MD956D |                            |  |
| <b>VIALLI</b>                               |       |                  |                                |                   |                     |  |                     |                                |        |                            |  |
| Cargo 50                                    | 06    | FA169            | FA169HH                        | TBA               |                     |  | TBA                 |                                |        |                            |  |
| DXB 50                                      | 06    | FA228            | FA228HH                        | TBA               |                     |  | TBA                 |                                |        |                            |  |
| Fireforce 50                                | 06    | FA228            | FA228HH                        | TBA               |                     |  | TBA                 |                                |        |                            |  |
| FXR Sport 50                                | 06    | FA169            | FA169HH                        | TBA               |                     |  | TBA                 |                                |        |                            |  |
| Jupiter 50                                  | 06    | FA169            | FA169HH                        | TBA               |                     |  | TBA                 |                                |        |                            |  |
| RX Sport 50                                 | 06    | FA83TT           | FA83HH                         | TBA               |                     |  | TBA                 |                                |        |                            |  |
| Truro 50                                    | 06    | FA86             | FA86HH                         |                   | TBA                 |  | TBA                 |                                |        |                            |  |
| <b>VOR</b>                                  |       |                  |                                |                   |                     |  |                     |                                |        |                            |  |
| All models with 2 piston Brembo calipers    | 99-02 | FA181TT          | FA181R■                        | N/A               |                     |  | FA208TT             | FA208R■                        | N/A    |                            |  |
| All models with 4 piston Ergal calipers     | 02    | TBA              | TBA                            | N/A               |                     |  | FA208TT             | FA208R■                        | N/A    |                            |  |
| EN 450/530 Enduro                           | 03-04 | FA181TT          | FA181R■                        | N/A               |                     |  | FA208TT             | FA208R■                        | N/A    |                            |  |
| EN-E 450/530 Enduro                         | 03-04 | FA181TT          | FA181R■                        | N/A               |                     |  | FA208TT             | FA208R■                        | N/A    |                            |  |
| SM-E 450/530                                | 03-04 | FA95             | FA95HH                         | N/A               |                     |  | FA208TT             | FA208R■                        | N/A    |                            |  |
| MX 450/530                                  | 03-04 | FA181TT          | FA181R■                        | N/A               |                     |  | FA208TT             | FA208R■                        | N/A    |                            |  |
| <b>VOXAN</b>                                |       |                  |                                |                   |                     |  |                     |                                |        |                            |  |
| Black Magic                                 | 04-05 | FA244*           | FA244HH*                       | MD614LS           | MD614RS             |  | FA266               | FA266HH                        | MD2002 | MD2002C                    |  |
| Street Scrambler                            | 03-05 | FA95*            | FA95HH*                        | MD614LS           | MD614RS             |  | FA266               | FA266HH                        | MD2002 | MD2002C                    |  |
| VB1-Evo                                     | 03-04 | FA244*           | FA244HH*                       | MD614LS           | MD614RS             |  | FA266               | FA266HH                        | MD2002 | MD2002C                    |  |
| Cyclope 1000                                | 02    | FA95*            | FA95HH*                        | N/A               | N/A                 |  | FA266               | FA266HH                        | N/A    |                            |  |
| Scrambler 1000                              | 02-06 | FA142*           | FA142HH*                       | N/A               | N/A                 |  | FA165/2TT           |                                | N/A    |                            |  |
| Cafe Racer 1000                             | 02-05 | FA95*            | FA95HH*                        | MD614LS           | MD614RS             |  | FA266               | FA266HH                        | MD2002 | MD2002C                    |  |
| Cafe Racer                                  | 06    | FA244*           | FA244HH*                       | MD614LS           | MD614RS             | MD614C*  | FA266               | FA266HH                        | MD2002 | MD2002C                    |  |
| Roadster 1000                               | 02-05 | FA95*            | FA95HH*                        | MD614LS           | MD614RS             |  | FA266               | FA266HH                        | MD2002 | MD2002C                    |  |
| Roadster                                    | 06    | FA244*           | FA244HH*                       | MD614LS           | MD614RS             | MD614C*  | FA266               | FA266HH                        | MD2002 | MD2002C                    |  |
| Charade Racing                              | 06    |                  | FA322/4HH*                     | N/A               | N/A                 |  | FA47                | FA47HH                         | N/A    |                            |  |
| <b>WUYANG</b>                               |       |                  |                                |                   |                     |  |                     |                                |        |                            |  |
| WY 50 QT                                    | 06-07 | FA169            | FA169HH                        | N/A               |                     |  | TBA                 |                                |        |                            |  |
| WY 125-12                                   | 06-07 | FA93             |                                | N/A               |                     |  | TBA                 |                                |        |                            |  |
| WY 125-16C                                  | 06-07 | FA93             |                                | N/A               |                     |  | TBA                 |                                |        |                            |  |
| WY 125-24B                                  | 06-07 | FA197            | FA197HH                        | N/A               |                     |  | TBA                 |                                |        |                            |  |
| WY 125-GY2                                  | 06-07 | TBA              |                                |                   |                     |  | TBA                 |                                |        |                            |  |
| <b>ZUNDAPP</b>                              |       |                  |                                |                   |                     |  |                     |                                |        |                            |  |
| KS 50 Sport/Supersport                      |       | FA50             |                                | N/A               |                     |  | 975                 |                                |        |                            |  |
| KS 80/Touring                               | 80-   | FA50             |                                | N/A               |                     |  | N/A                 |                                |        |                            |  |
| KS 80 Super                                 | 83    | FA60             |                                | N/A               |                     |  | N/A                 |                                |        |                            |  |
| KS 80 Super                                 | 84-   | FA99             |                                | N/A               |                     |  | N/A                 |                                |        |                            |  |
| KS 100                                      |       | FA50             |                                | N/A               |                     |  | 975                 |                                |        |                            |  |
| KS 125                                      | -81   | FA76             |                                | N/A               |                     |  | N/A                 |                                |        |                            |  |
| KS 125/KS 175                               | 82-   | FA18             | FA18HH                         | N/A               |                     |  | N/A                 |                                |        |                            |  |

\*-2 Sets Required. ■ - Also available in MX-S race compound, see page 8. ✖ - Oversize and Supermoto disc available - see page 301.

**SAFETY WARNING-** DO NOT USE HH PADS ON REAR UNLESS ALSO USED ON FRONT TO AVOID BRAKE IMBALANCE.

**R** Suffix = High Durability Sintered Pad. **HH** Suffix = High Performance Sintered Pad. **G** Suffix = Grooved Shoe.  
**D** Suffix = Drilled Disc. **C** Suffix = Contoured Disc. **LS** Suffix = Left/Steel Disc. **RS** = Right/Steel Disc.

**BRAKE APPLICATIONS**

# DISC PAD BUYERS GUIDE

## FA11 48 x 9mm

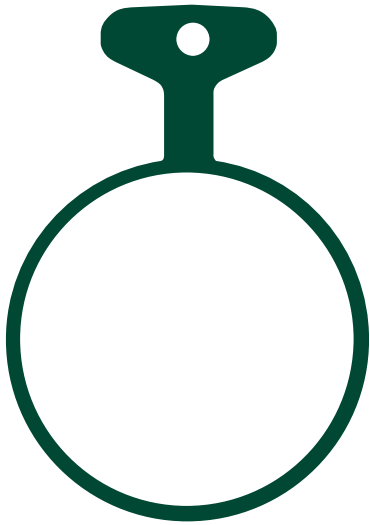

### YAMAHA

|              |       |       |
|--------------|-------|-------|
| RD 250 A/B/C | 75-77 | F     |
| RD 250 D     | 77    | F & R |
| RD 350 A/B   | 74-76 | F     |
| XS 360 B     | 75    | F     |
| RD 400 C/D   | 76-77 | F & R |
| TX/XS 500 B  | 75-77 | F     |
| XS 650       | 75    | F     |

### ISR CALIPERS

|                              |   |
|------------------------------|---|
| 22-023-0A (2 Piston)         | F |
| 22-026-0A (Sprocker Caliper) | F |

### Competitor X Ref

| Dunlop | Ferodo | SBS | Vesrah |
|--------|--------|-----|--------|
| DP400  | FDB157 | 504 | VD-201 |

### Equivalents OE #

|              |              |
|--------------|--------------|
| 1A1 W0045 00 | 306 25811 06 |
| 306 25811 04 | 409 W0045 00 |
| 306 25811 05 | 409 25811 01 |

### MATERIAL AVAILABILITY AND PART NO.

| STD  | OPTIONS |   |     |     |
|------|---------|---|-----|-----|
| FA   | HH      | R | MXS | GFA |
| FA11 | -       | - | -   | -   |

## FA12 50 x 13/20mm

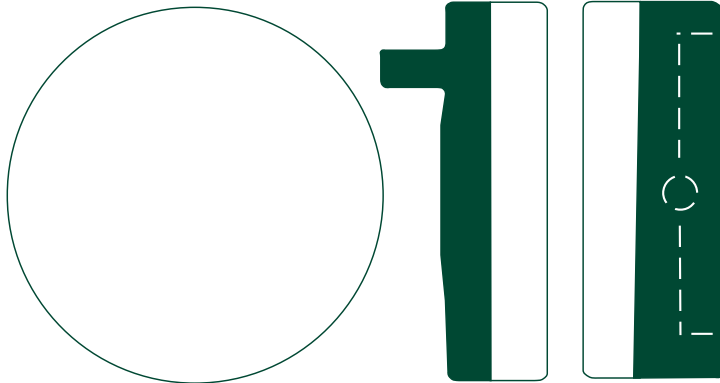

### HONDA

|              |       |   |
|--------------|-------|---|
| CB 750 K0-K6 | 69-77 | F |
|--------------|-------|---|

### Equivalents OE #

|                 |                 |
|-----------------|-----------------|
| 45105 300 040 A | 45106 341 000 B |
| 45105 341 000 A | 45106 341 003 B |
| 45105 341 003 A | 45106 300 004 B |

### Competitor X Ref

| Dunlop | Ferodo | SBS | Vesrah |
|--------|--------|-----|--------|
| -      | -      | 502 | VD-101 |

### MATERIAL AVAILABILITY AND PART NO.

| STD  | OPTIONS |   |     |     |
|------|---------|---|-----|-----|
| FA   | HH      | R | MXS | GFA |
| FA12 | -       | - | -   | -   |

## FA13 52 x 13/20mm

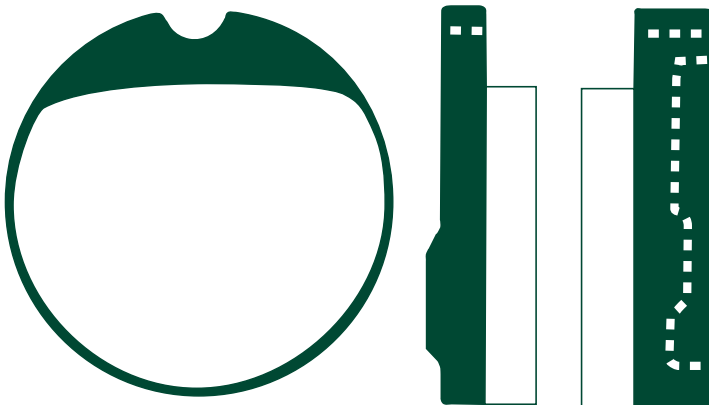

### HONDA

|                   |       |   |
|-------------------|-------|---|
| CB 250 G5         | 75    | F |
| CJ 250 T          | 77    | F |
| CB 360 G5         | 75    | F |
| CJ 360 T          | 78    | F |
| CB 400 F/F1/F2    | 75-79 | F |
| CB 500 T          | 75-77 | F |
| CB 500 K1/K2/F    | 75-77 | F |
| CB 550 F/F1/F2/F3 | 78-80 | F |
| CB 750 F/F1       | 76-77 | F |
| CB 750 K7         | 78    | F |

### Competitor X Ref

| Dunlop | Ferodo | SBS | Vesrah    |
|--------|--------|-----|-----------|
| -      | FDB119 | 501 | VD102-106 |

### Equivalents OE #

|                 |                 |                 |
|-----------------|-----------------|-----------------|
| 45102 393 700   | 45105 323 043 A | 45106 323 036 B |
| 45105 323 006 A | 45105 390 003 A | 45106 323 043 B |
| 45105 323 013 A | 45105 390 006 A | 45106 390 003 B |
| 45105 323 023 A | 45106 323 013 B |                 |
| 45105 323 036 A | 45106 323 023 B |                 |

### MATERIAL AVAILABILITY AND PART NO.

| STD  | OPTIONS |   |     |     |
|------|---------|---|-----|-----|
| FA   | HH      | R | MXS | GFA |
| FA13 | -       | - | -   | -   |

# FA16 59.7 x 51.6 x 10mm

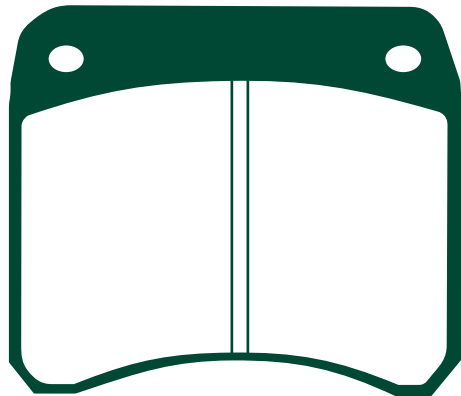

## DUCATI

750 Sport 74 F

## ISR CALIPERS

22-030 (2 piston rear) F

22-033 (2 piston HD) F

## LOCKHEED

2 Piston Caliper

## TRIUMPH

Bonneville 750 Twin (Lockheed caliper) -84 F&R

Equivalents OE # N/A

### Competitor X Ref

| Dunlop | Ferodo  | SBS | Vesrah |
|--------|---------|-----|--------|
| DP500  | FDB342R | 698 | VD-906 |

| MATERIAL AVAILABILITY AND PART NO. |         |   |     |         |
|------------------------------------|---------|---|-----|---------|
| STD                                | OPTIONS |   |     |         |
| FA                                 | HH      | R | MXS | GFA     |
| FA16                               | FA16HH  | - | -   | GFA16HH |
| FA16'S' (Green)                    |         |   |     |         |

# FA18 55.7 x 55 x 9mm

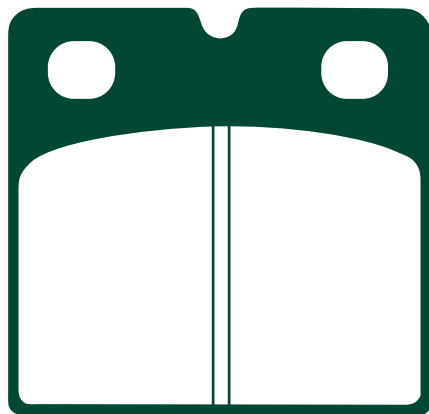

### Equivalents OE #

|                 |             |
|-----------------|-------------|
| 34 11 1 451 995 | 14654601    |
| 34 11 1 454 724 | 14654650    |
| 34 11 1 458 388 | 0795 39 856 |
| 34 1 2 301 360  | 0979 39 856 |
| 34 21 7 657 025 | 0960 39 656 |
| 34 21 1 236 221 | 61654630    |
| 34 21 2 332 988 |             |

### Competitor X Ref

| Dunlop | Ferodo     | SBS | Vesrah |
|--------|------------|-----|--------|
| DP600  | FDB108/148 | 506 | VD-907 |

| MATERIAL AVAILABILITY AND PART NO. |         |   |     |     |
|------------------------------------|---------|---|-----|-----|
| STD                                | OPTIONS |   |     |     |
| FA                                 | HH      | R | MXS | GFA |
| FA18                               | FA18HH  | - | -   | -   |

## BENELLI

354 -82 R  
 K 75/75-S 75- F  
 900 SEi (6 cyl) 83 F

## BIMOTA

All early models -83 F & R

## BMW

K 75/75-S 84-90 F  
 K 75/75-S 08/90-96 R  
 K 75 C 85-08/88 F  
 K 75 RT 89-96 R  
 K 75 S 85-09/88 F&R  
 K 75 S 09/88-95 R  
 K 75 S 85-09/88 F&R  
 K 75 S 09/88-85 R  
 K 1000 82-09/88 F&R  
 K 100/2 87-08/88 F&R  
 K 100/2 09/88-90 R  
 K 100/2 87-08/88 F&R  
 K 100/2 09/88-90 R  
 K 100 LT 86-08/88 F&R  
 K 100 LT 09/88-91 R  
 K 100 LT 86/08-88 F&R  
 K 100 LT 09/88-91 R  
 K 100 RS 83-09/88 F&R  
 K 100 RS 10/88-89 R  
 K 100 RS 83-09/88 F&R  
 K 100 RS 10/88-89 R  
 K 100 RS 83-09/88 F&R  
 K 100 RT 83-09/88 F&R  
 K 100 RT 10/88-89 R  
 K 100 RT 83-09/88 F&R  
 K 100 RT 10/88-89 R  
 K 100 RT 83-09/88 F&R  
 K 100 RT 10/88-89 R  
 K 100 RS 89-92 R  
 K 100 RS 89-92 R  
 K 100 RS 88-93 R  
 K1 89-07/93 R  
 KL 1100 LT 89-07/93 R  
 KL 1100 LT 08/93-99 R

## BMW Contd.

KL 1100 LT 08/93-99 R  
 K 1100 RS 92-96 R  
 K 1100 RS 92-96 R  
 K 1200 RS 96-00 R  
 K 1200 RS 01-04 R  
 K 1200 GT 03-06 R  
 R 45/45N 78-85 F  
 R 65 07/88-92 F  
 R 65 T (Brembo Caliper) 80-85 F  
 R 65 LS (Brembo Caliper) 81-85 F  
 R 65 GS 87-92 F  
 R 65 RT 85-88 F  
 R 80 RT 82-84 F  
 R 80/R 80 RT 84-08/88 F  
 R 80 GS 80-87 F  
 R 80 ST 82-84 F  
 R 80 TIC 09/80-85 F  
 R 100/7T 09/80-84 F  
 R 100 S 09/80-90 F&R  
 R 100 RS 10/80-84 F&R  
 R 100 RS 86-08/88 F  
 R 100 RT 10/80-84 F&R  
 R 100 RT 87-08/88 F  
 R 100 RS 92-01 R

## DUCATI

250/350/450 Desmo -76 F  
 600 Pantah 81 F&R  
 650 Pantah -84 F&R  
 750 SS 75-76 F&R  
 751 F1 98 F&R  
 750 Paso 87-90 F  
 750 Sport 88-90 F&R  
 860 GT/GTS 75-76 F&R  
 900 GTS 75-76 F&R  
 900 SS Darmah 76-78 F&R  
 900 Hailwood Replica 79 F&R  
 906 Paso 88-89 F&R

## DUCATI Contd.

1000 R1 Hailwood Replica 84 F&R  
**HOREX**  
 HRD 600 85 F & R  
 500/600 Columbus 88- F & R  
**LAVERDA**  
 750 SF2 74 F  
 750 SFC 74 F&R  
 750 SF3 76-77 F&R  
 1000 3C 74-75 F&R  
 1000 3CL 76-78 F&R  
 1000 3CL Jarama/Jota 79-81 F&R  
 1000 RGS 82 F&R  
 1000 RGA/RGS Exec 83 F&R  
 1000 RGS Corsa 84 R  
 1000 SFC 85-86 F&R  
**MOTO GUZZI**  
 850 All models 75- F & R  
 1000 Spada 78-94 F  
 Le Mans 1000 92-94 F & R  
 1000 S/SE 92-93 F & R  
 California/LAPD/Classic 92-95 F & R  
 California 1100 Carb/Injection 94-97 F & R

## MZ

ETZ 125/150/250/300 85-92 F  
 Saxon 125/251/301/500 93-97 F  
 Saxon 150 95 F  
 Saxon Tour 251/301 93-98 F  
 251 Fun 95-96 F  
 Saxon 500 All models 93-98 F

## TRIUMPH

Bonneville 750 Twin (Brembo caliper) 85-86 F&R

# FA21 47 x 16.2mm

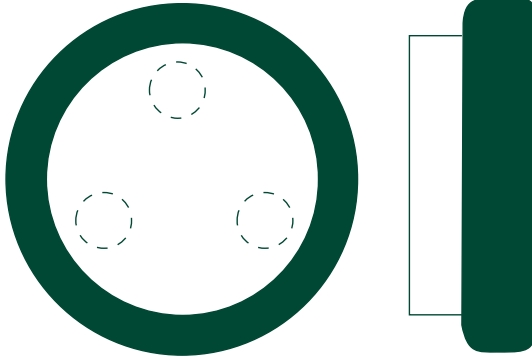

## YAMAHA

|                         |       |   |
|-------------------------|-------|---|
| YFM 200 N/DXW/DX/DXA    | 85-90 | R |
| YTM 200 EL/DX           | 89    | R |
| YTM 225 DRN             | 85    | R |
| YFM 225 S/T/U           | 86-89 | R |
| YFM 250 W/A/B           | 90-92 | R |
| YFM 350 FWT/FWU/FWW/FWA |       |   |
| FWB/FWD/FWE/FWF/        |       |   |
| FWG "Big Bear"          | 87-95 | R |
| YFM 350 ERD/ERE/ERF/ERG | 92-95 | R |

| MATERIAL AVAILABILITY AND PART NO. |         |       |     |     |
|------------------------------------|---------|-------|-----|-----|
| STD                                | OPTIONS |       |     |     |
| FA                                 | HH      | R     | MXS | GFA |
| FA21                               | -       | FA21R | -   | -   |

### Equivalents OE #

|                  |               |               |            |               |              |              |
|------------------|---------------|---------------|------------|---------------|--------------|--------------|
| Competitor X Ref | <b>Dunlop</b> | <b>Ferodo</b> | <b>SBS</b> | <b>Vesrah</b> | 2HR W0045 00 | 5V6 W0045 01 |
|                  | -             | -             | 576        | VD234         | 5V6 W0045 00 |              |

# FA22 71.8 x 35mm

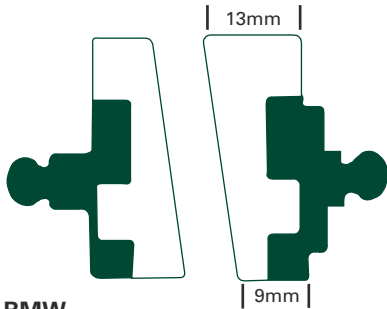

**Note: 1 pad left  
1 pad right  
Tapered finish**

## BMW

|             |          |   |
|-------------|----------|---|
| R 60/7      | 76-80    | F |
| R 60 TIC    | 78-82    | F |
| R 75/6/75/7 | 73-79    | F |
| R 80        | 77-84    | F |
| R 80 TIC    | 78-08/80 | F |
| R 90 S      | 73-76    | F |
| R 90/6      | 73-76    | F |
| R 100       | 76-77    | F |
| R 100/TT    | 77-09/80 | F |
| R 100 S     | 76/08/80 | F |
| R 100 RS    | 76-09/80 | F |
| R 100 RT    | 78-09/80 | F |

## Competitor X Ref

|               |               |            |               |
|---------------|---------------|------------|---------------|
| <b>Dunlop</b> | <b>Ferodo</b> | <b>SBS</b> | <b>Vesrah</b> |
| -             | FDB155        | 520        | VD910         |

### Equivalents OE #

|                 |                 |
|-----------------|-----------------|
| 34 11 2 301 358 | 34 11 1 233 319 |
|-----------------|-----------------|

| MATERIAL AVAILABILITY AND PART NO. |         |   |     |     |
|------------------------------------|---------|---|-----|-----|
| STD                                | OPTIONS |   |     |     |
| FA                                 | HH      | R | MXS | GFA |
| FA22                               | -       | - | -   | -   |

# FA24/2 113.8 x 66.8 x 7mm

## HARLEY DAVIDSON

|                      |       |   |
|----------------------|-------|---|
| FX/FXE/FXEF/FXWG/FXS | 73-83 | R |
| FL/FLH               | 72-84 | F |
| FL/FLH               | 72-80 | R |

**(BANANA CALIPER)**

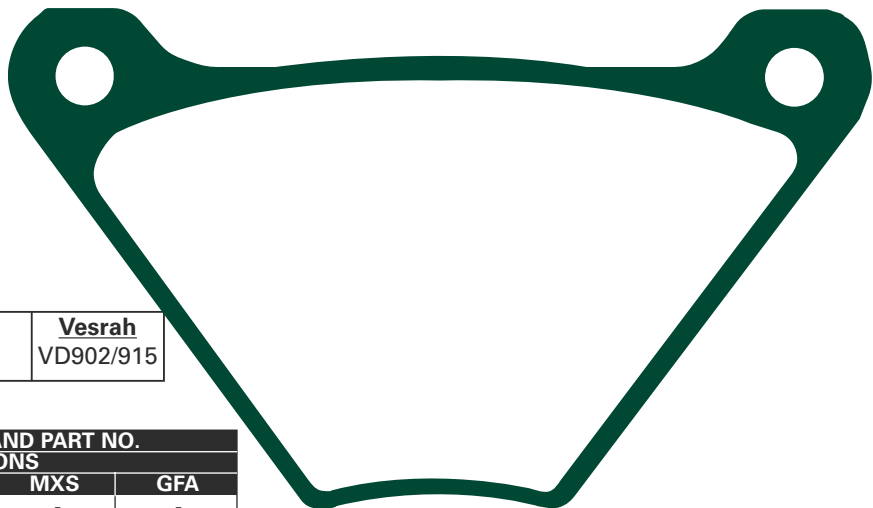

### Equivalents OE #

|          |
|----------|
| 44005 74 |
| 44135 74 |

### Competitor X Ref

|               |               |            |               |
|---------------|---------------|------------|---------------|
| <b>Dunlop</b> | <b>Ferodo</b> | <b>SBS</b> | <b>Vesrah</b> |
| DP906         | FDB185/R      | 513        | VD902/915     |

| MATERIAL AVAILABILITY AND PART NO. |         |   |     |     |
|------------------------------------|---------|---|-----|-----|
| STD                                | OPTIONS |   |     |     |
| FA                                 | HH      | R | MXS | GFA |
| FA24/2                             | -       | - | -   | -   |



# FA26 78 x 52.5 x 6.3mm

## HARLEY DAVIDSON

FX, FXE, FXEF, FXWG, FXS 73-77 F  
 XL, XLH, XLCH, XLS, XLX 73-77 F

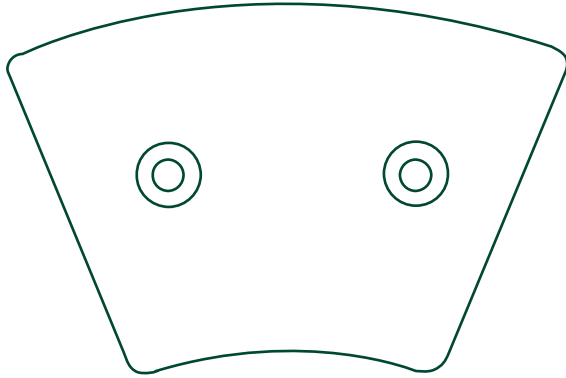

**COMPLETE WITH  
TWO RIVETS**

### Equivalents OE #

### Competitor X Ref

| Dunlop | Ferodo | SBS | Vesrah |
|--------|--------|-----|--------|
| -      | -      | 679 | VD901  |

| MATERIAL AVAILABILITY AND PART NO. |         |   |     |     |
|------------------------------------|---------|---|-----|-----|
| STD                                | OPTIONS |   |     |     |
| FA                                 | HH      | R | MXS | GFA |
| FA26                               | -       | - | -   | -   |

# FA27 44.4 x 55.4 x 9.5mm

## NORTON

Commando Mk3 71-75 F & R



### Equivalents OE #

|         |         |
|---------|---------|
| 06 6005 | 06 6186 |
| 06 1894 |         |

### Competitor X Ref

| Dunlop | Ferodo | SBS | Vesrah |
|--------|--------|-----|--------|
| -      | FDB88  | 505 | VD904  |

| MATERIAL AVAILABILITY AND PART NO. |         |   |     |     |
|------------------------------------|---------|---|-----|-----|
| STD                                | OPTIONS |   |     |     |
| FA                                 | HH      | R | MXS | GFA |
| FA27                               | -       | - | -   | -   |

# FA28 45.3 x 12/15.5mm

## YAMAHA

FSIE DX 77-79 F  
 RD 50 M 78 F  
 RS 100 DX 77-80 F  
 RD 125 DX 75-77 F  
 RS 125 DX 76-80 F  
 RD 200 DX 75-78 F

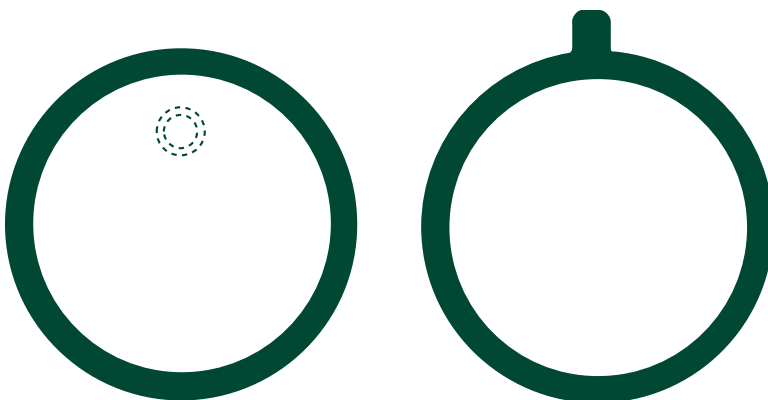

### Competitor X Ref

| Dunlop | Ferodo | SBS | Vesrah    |
|--------|--------|-----|-----------|
| -      | -      | 500 | VD202/203 |

### Equivalents OE #

|              |              |
|--------------|--------------|
| 1V1 W0045 00 | 404 W0045 12 |
| 404 2000 11  | 464 20000 11 |
| 404 2000 12  | 464 20000 12 |

| MATERIAL AVAILABILITY AND PART NO. |         |   |     |     |
|------------------------------------|---------|---|-----|-----|
| STD                                | OPTIONS |   |     |     |
| FA                                 | HH      | R | MXS | GFA |
| FA28                               | -       | - | -   | -   |

# FA29 67 x 49.2 x 11mm

# FA30 67 x 49.2 x 10mm

# FA31 67 x 49.2 x 9mm

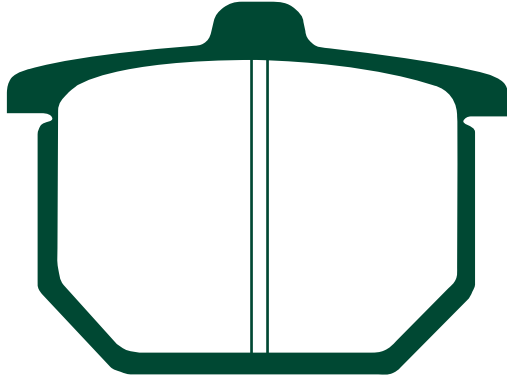

**Competitor X Ref**

|      | <u>Dunlop</u> | <u>Ferodo</u> | <u>SBS</u> | <u>Vesrah</u> |
|------|---------------|---------------|------------|---------------|
| FA29 | DP102         | -             | 508        | VD107/112     |
| FA30 | DP101         | FDB182        | -          | VD112/3       |
| FA31 | -             | -             | 517        | VD112         |

**Equivalents OE #  
FA30**

|               |               |               |
|---------------|---------------|---------------|
| 43105 461 771 | 45105 415 772 | 45105 438 008 |
| 43105 461 772 | 45105 438 000 | 06455 410 405 |
| 45105 415 006 | 45105 438 004 | 06435 410 305 |
| 45105 415 770 | 45105 438 007 | 06435 415 405 |

| MATERIAL AVAILABILITY AND PART NO. |         |   |     |     |
|------------------------------------|---------|---|-----|-----|
| STD                                | OPTIONS |   |     |     |
| FA                                 | HH      | R | MXS | GFA |
| FA30                               | -       | - | -   | -   |

**FA29 - HONDA**

|                          |       |   |
|--------------------------|-------|---|
| CX 500 CA/CB/Z/A/B       | 79-81 | F |
| CBX 1000 Z               | 79-80 | F |
| GL 1000 K3/KZ "Goldwing" | 78-79 | F |

**FA30 - HONDA**

|                               |       |       |
|-------------------------------|-------|-------|
| CB 400 N/NA/NB                | 78-81 | F     |
| CB 750 F2                     | 79    | R     |
| CBX 1000 Z                    | 79-80 | R     |
| GL 1000 K/K1/K2/KZ 'Goldwing' | 75-77 | F     |
| GL 1100 A/DA/B/DB (SC02)      | 80-81 | F & R |

**FA31 - HONDA**

|                 |       |       |
|-----------------|-------|-------|
| CB 750 F2       | 79    | F     |
| CB 750 FZ/FA/FB | 78-82 | F & R |
| CB 900 FZ/FA    | 80-81 | F & R |

**Equivalents OE #  
FA29**

|               |               |
|---------------|---------------|
| 43105 461 771 | 45105 410 004 |
| 43105 461 772 | 45105 410 006 |
| 45105 415 006 | 45105 410 007 |
| 45105 415 770 | 45105 410 016 |
| 45105 415 772 | 45105 410 026 |

**Equivalents OE #  
FA31**

|               |               |
|---------------|---------------|
| 43105 461 770 | 06435 761 405 |
| 45105 371 00  | 06455 371 405 |

| MATERIAL AVAILABILITY AND PART NO. |         |   |     |     |
|------------------------------------|---------|---|-----|-----|
| STD                                | OPTIONS |   |     |     |
| FA                                 | HH      | R | MXS | GFA |
| FA29                               | -       | - | -   | -   |

| MATERIAL AVAILABILITY AND PART NO. |         |   |     |     |
|------------------------------------|---------|---|-----|-----|
| STD                                | OPTIONS |   |     |     |
| FA                                 | HH      | R | MXS | GFA |
| FA31                               | -       | - | -   | -   |

# FA32 57.8 x 65.3 x 11mm

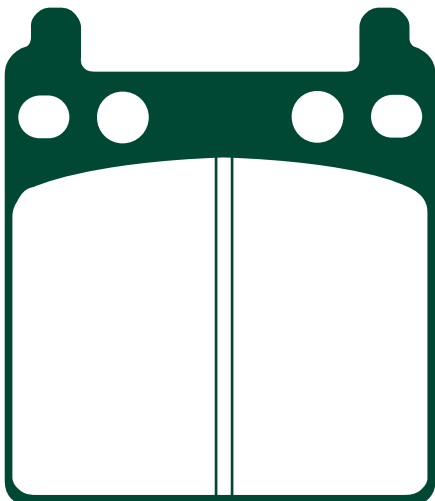

**HONDA**

|                                  |       |   |
|----------------------------------|-------|---|
| CB 750 F/F1                      | 76-77 | R |
| GL 1000 K/K1/K2/K3/KZ 'Goldwing' | 75-79 | R |

**PERFORMANCE MACHINE**

162X2

**Competitor X Ref**

| <u>Dunlop</u> | <u>Ferodo</u> | <u>SBS</u> | <u>Vesrah</u> |
|---------------|---------------|------------|---------------|
| -             | FDB134R       | 509        | VD108/116     |

**Equivalents OE #**

|               |               |
|---------------|---------------|
| 431A0 431 673 | 43211 431 671 |
| 43211 371 006 | 43211 431 672 |
| 43211 392 006 | 43211 431 673 |
| 43211 392 016 |               |

| MATERIAL AVAILABILITY AND PART NO. |         |   |     |     |
|------------------------------------|---------|---|-----|-----|
| STD                                | OPTIONS |   |     |     |
| FA                                 | HH      | R | MXS | GFA |
| FA32                               | -       | - | -   | -   |

# FA33 A = 51.3 x 12.3mm B = 50 x 12.5mm

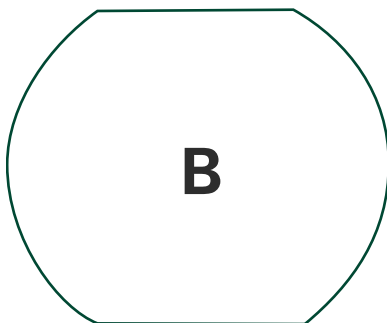
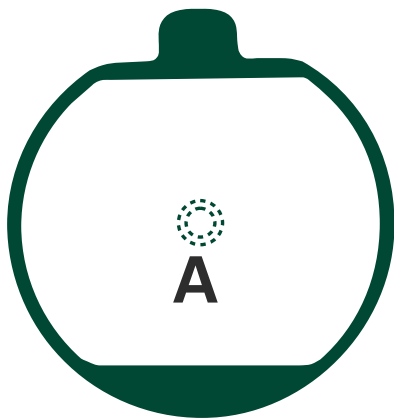

## KAWASAKI

|                     |       |   |
|---------------------|-------|---|
| KH 250 B1-B5        | 77-82 | F |
| KH 400 'All models' | 76-81 | F |
| Z 400 G1            | 79    | F |
| KH 500 A8           | 76    | F |
| Z 650 B1-B3         | 79-81 | F |
| Z 650 C1/C2         | 76-77 | F |
| Z 750 B1/B2/D1      | 76-78 | F |
| Z 900 A4            | 77-78 | F |
| Z 1000 A1-A2        | 74-82 | F |
| Z 1000 D1 (Z1-R)    | 78-   | F |
| Z 1000 H1           | 74    | F |

## Equivalents OE #

|             |             |             |
|-------------|-------------|-------------|
| 43050 005 A | 43050 1006  | 43051 007 B |
| 43050 006 A | 43050 1021  | 43051 008 B |
| 43050 007 A | 43050 5001  | 43051 011 B |
| 43050 008 A | 43050 5002  | 43082 1001  |
| 43050 009 A | 43050 5003  | 43082 1005  |
| 43050 011 A | 43051 006 B |             |

## Competitor X Ref

| MATERIAL AVAILABILITY AND PART NO. |         |   |     |     |
|------------------------------------|---------|---|-----|-----|
| STD                                | OPTIONS |   |     |     |
| FA                                 | HH      | R | MXS | GFA |
| FA33                               | -       | - | -   | -   |

| Dunlop | Ferodo | SBS | Vesrah                |
|--------|--------|-----|-----------------------|
| DP300  | FDB132 | 510 | VD404/408/<br>409/411 |

# FA34 57.8 x 65.3 x 11mm

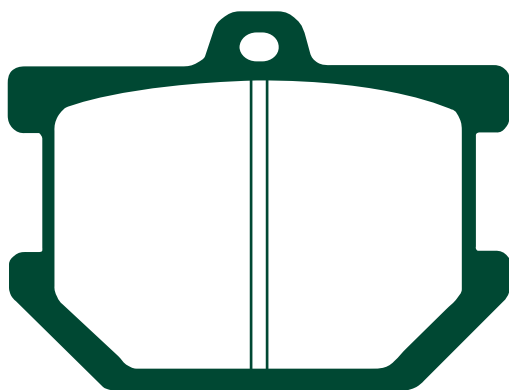

## YAMAHA

|                    |       |       |
|--------------------|-------|-------|
| XS 250 C           | 78    | F & R |
| XS 250 D/E         | 79-81 | F     |
| XS 360 C           | 76    | F & R |
| XS 400 C           | 78    | F & R |
| XS 400             | 79    | F     |
| SR 500             | 78-82 | F     |
| XS 500 C/D         | 78-79 | F & R |
| XJ 650             | 80-84 | F     |
| XJ 650 LH Midnight | 81    | F     |
| XJ 650 RJ 'Seca'   | 82    | F     |
| XS 650             | 77-81 | F     |
| XS 650 SE          | 79-80 | F & R |
| XS 650 SE          | 81    | F     |
| XS 750             | 77-79 | F & R |
| XS 750 SE          | 79-80 | R     |
| XS 850             | 80    | F & R |
| XV 1000 TRI        | 81    | F     |
| XS 1100            | 78-80 | F & R |
| XS 1100 S          | 81    | R     |

## Equivalents OE #

|              |              |              |              |
|--------------|--------------|--------------|--------------|
| 1J3 20000 10 | 1J3 W0045 00 | 1U4 W0046 01 | 2M0 W0046 01 |
| 1J3 20000 13 | 1J3 W0046 00 | 1U4 W0046 02 | 3G1 W0046 00 |
| 1J3 20000 63 | 1J9 20000 02 | 2J2 W0046 00 | 3H5 W0045 01 |
| 1J3 20000 64 | 1L9 W0045 00 | 2J2 W0046 01 | 4K0 W0045 00 |
| 1J3 20000 70 | 1L9 W0046 00 | 2M0 W0046 00 | 4K0 W0045 01 |

## Competitor X Ref

| Dunlop | Ferodo  | SBS | Vesrah    |
|--------|---------|-----|-----------|
| DP401  | FDB177R | 507 | VD205-212 |

| MATERIAL AVAILABILITY AND PART NO. |         |   |     |     |
|------------------------------------|---------|---|-----|-----|
| STD                                | OPTIONS |   |     |     |
| FA                                 | HH      | R | MXS | GFA |
| FA34                               | -       | - | -   | -   |

# FA35 51 x 11/12mm

## SUZUKI

|                      |       |   |
|----------------------|-------|---|
| GS 400 B/C           | 77-78 | F |
| GS 425 EN            | 78-80 | F |
| GS 750 B/DB/DC/EC/EN | 77-80 | F |

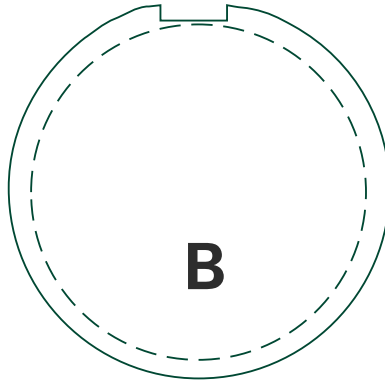
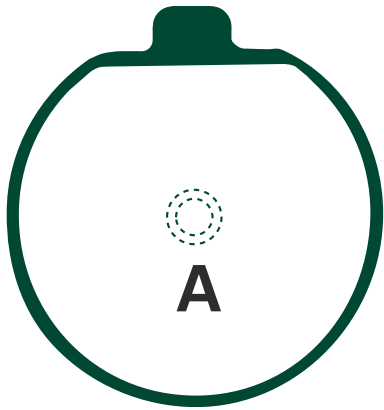

### Equivalents OE #

|             |             |
|-------------|-------------|
| 59100 45820 | 59300 44822 |
| 59300 44810 | 59300 45890 |
| 59300 44820 | 59300 45891 |
| 59300 44821 |             |

### Competitor X Ref

| Dunlop | Ferodo | SBS | Vesrah |
|--------|--------|-----|--------|
| -      | FDB150 | 511 | VD305  |

### MATERIAL AVAILABILITY AND PART NO.

| STD  | OPTIONS |   |     |     |
|------|---------|---|-----|-----|
| FA   | HH      | R | MXS | GFA |
| FA35 | -       | - | -   | -   |

# FA36 57.6 x 52.8 x 9mm

## SUZUKI

|                                     |       |   |
|-------------------------------------|-------|---|
| GSX 400 FX/FZ/FD                    | 81-83 | R |
| GS 550 EC/EN                        | 78-79 | R |
| GS 550 ET/EX/EZ/LT/LX/MX/MZ         | 80-84 | R |
| XN 85 Turbo                         | 83    | R |
| GS 650 GTX/GTZ/GTD/GX/GZ            | 81-83 | R |
| GS 700 EF/ESF                       | 85    | R |
| GS 750 B/DB/DC/EC/EN                | 77-80 | R |
| GSX 750 ET/EX/ESD/EFE/ESG           |       |   |
| /ESE/ESH/ESF                        | 82-86 | R |
| GSX 750 SE Katana                   | 85    | R |
| GSX 750 S/SS (G57SX-106815-) Katana | 84    | R |
| GSX 750 S-2/S-2C                    |       |   |
| (GS75X-114747-) Katana              | 84    | R |
| GS 850 GN/GT/GX/GZ/GE/GG            | 79-85 | R |
| GS 1000 HC/EC/EN/SN                 | 78-80 | R |
| GS 1000 ET/GT/GX                    | 81-82 | R |
| GSX 1000 SZ "Katana"                | 82    | R |
| GSX 1100 ET/EX/EZ/ESD               | 80-83 | R |
| GS 1100 GZ                          | 82    | R |
| GSX 1100 SZ/SD Katana               | 82-83 | R |
| GV 1200 GLF/GLF2/GLG Madura         | 85-86 | R |

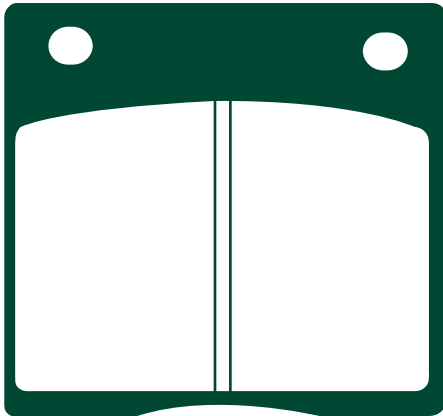

### Equivalents OE #

|             |             |             |
|-------------|-------------|-------------|
| 43050 010   | 69130 45001 | 69130 45990 |
| 43050 1013  | 69130 45010 | 69100 34870 |
| 43082 1059  | 69130 45020 | 69101 45820 |
| 69130 34220 | 69130 45021 | 69101 45840 |
| 69130 34240 | 69130 45100 |             |
| 69130 45000 | 69130 45101 |             |

### Competitor X Ref

| Dunlop | Ferodo  | SBS | Vesrah |
|--------|---------|-----|--------|
| DP203  | FDB151R | 512 | VD306  |

## KAWASAKI

|                         |       |   |
|-------------------------|-------|---|
| Z 500 B1/B2             | 79-80 | R |
| Z 650 C3/D2/D3-SR       | 78-80 | R |
| Z 650 D2/D3 (SR)        | 79-80 | R |
| Z 1000 D1/D3 (Z1R)      | 78-79 | R |
| Z 1000 A1-A4            | 77-80 | R |
| Z 1000 ST (E1-E2 shaft) | 79-82 | R |
| Z 1000 H1               | 74    | R |
| Z 1300 A1-A5            | 79-83 | R |
| ZG 1300 A1-A3           | 84-86 | R |

### MATERIAL AVAILABILITY AND PART NO.

| STD  | OPTIONS |   |     |     |
|------|---------|---|-----|-----|
| FA   | HH      | R | MXS | GFA |
| FA36 | -       | - | -   | -   |

# FA37 51.5 x 13/12mm

## KAWASAKI

|             |       |   |
|-------------|-------|---|
| Z 650 C1/C2 | 76-77 | R |
| Z 750 B1/B2 | 77-78 | R |
| Z 750 D1    | 76    | R |

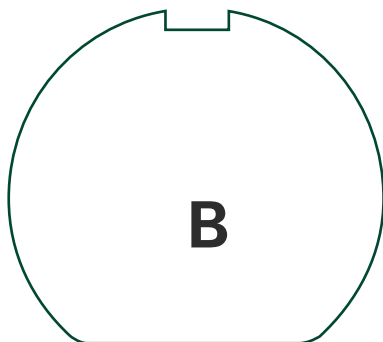
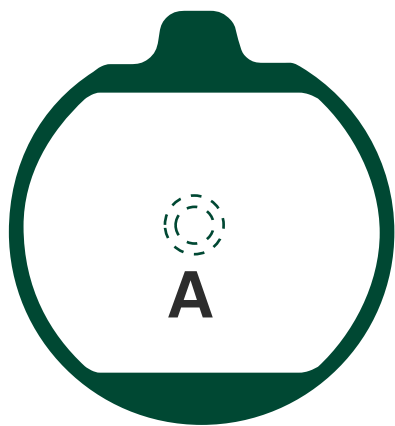

### Equivalents OE #

|              |            |
|--------------|------------|
| 43051 009 B  | 43050 1006 |
| 43050 1008 A | 43050 5002 |

### Competitor X Ref

| Dunlop | Ferodo  | SBS | Vesrah    |
|--------|---------|-----|-----------|
| -      | FDB181R | 514 | VD405/412 |

### MATERIAL AVAILABILITY AND PART NO.

| STD  | OPTIONS |   |     |     |
|------|---------|---|-----|-----|
| FA   | HH      | R | MXS | GFA |
| FA37 | -       | - | -   | -   |

# FA38 A. 50 x 12mm B. 50 x 11.9mm

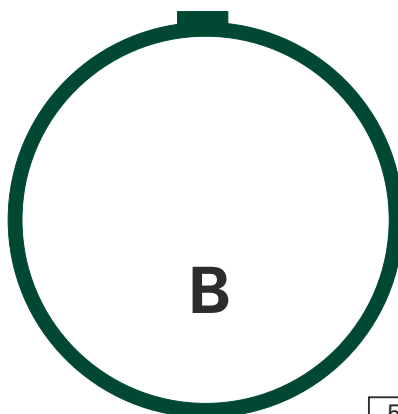
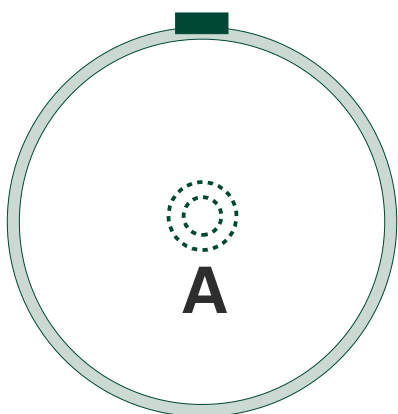

## SUZUKI

|                      |       |   |
|----------------------|-------|---|
| GT 125 C/EC/EN       | 80-82 | F |
| GT 200 EN/EX "X5"    | 79-82 | F |
| GT 250 EN/ET/EX "X7" | 78-81 | F |
| GS 550 DB/DC/EC/EN   | 77-79 | F |
| GS 850 GN/GT/GX      | 79-81 | F |
| GS 1000 HC/EC/EN/SN  | 78-80 | F |

### Equivalents OE #

|             |             |
|-------------|-------------|
| 59100 11850 | 59300 47820 |
| 59100 34820 | 59300 47830 |
| 59300 45820 | 59300 47840 |
| 59300 47810 | 59300 47850 |

### Competitor X Ref

| Dunlop | Ferodo  | SBS | Vesrah                           |
|--------|---------|-----|----------------------------------|
| -      | FDB181R | 515 | VD307/308<br>310/315/<br>316/320 |

### MATERIAL AVAILABILITY AND PART NO.

| STD  | OPTIONS |   |     |     |
|------|---------|---|-----|-----|
| FA   | HH      | R | MXS | GFA |
| FA38 | -       | - | -   | -   |

# FA39 43.50Ø x 12/10mm

## KAWASAKI

|              |       |   |
|--------------|-------|---|
| KH 125 A1-A4 | 77-81 | F |
| Z 200 A1-A5  | 77-82 | F |

## SUZUKI

|                    |       |   |
|--------------------|-------|---|
| GT 50 KB/KEN       | 77-80 | F |
| ZR 50 KEN/KEX "X1" | 79-83 | F |

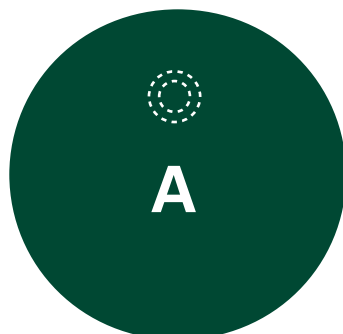
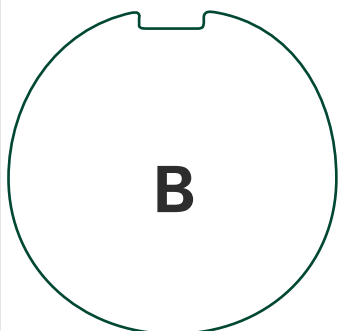

### Equivalents OE #

|              |             |
|--------------|-------------|
| 43050 1009 A | 59300 46811 |
| 43050 1010 B | 59300 46820 |
| 59300 46810  |             |

### Competitor X Ref

| Dunlop | Ferodo | SBS | Vesrah    |
|--------|--------|-----|-----------|
| -      | -      | 516 | VD309/410 |

| MATERIAL AVAILABILITY AND PART NO. |         |   |     |     |
|------------------------------------|---------|---|-----|-----|
| STD                                | OPTIONS |   |     |     |
| FA                                 | HH      | R | MXS | GFA |
| FA39                               | -       | - | -   | -   |

# FA40 41 x 21/11mm

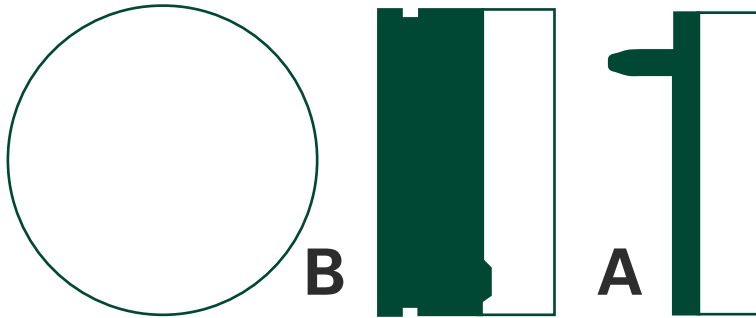

### HONDA

|                |       |   |
|----------------|-------|---|
| CB 50 J        | 81    | F |
| SS 50 ZB2      | 77-80 | F |
| CB 125 J/T     | 78-79 | F |
| FL 250 Odyssey | 77-84 | R |

### POLARIS

|                     |       |   |
|---------------------|-------|---|
| Trail Boss 2 x 4    | 85-87 | R |
| Scrambler 3 wheeler | 85-86 | R |
| Cyclone '250 X'     | 87    | R |

#### Competitor X Ref

| Dunlop | Ferodo | SBS | Vesrah    |
|--------|--------|-----|-----------|
| -      | -      | 525 | VD109/111 |

#### MATERIAL AVAILABILITY AND PART NO.

| STD  | OPTIONS |   |     |     |
|------|---------|---|-----|-----|
| FA   | HH      | R | MXS | GFA |
| FA40 | -       | - | -   | -   |

#### Equivalents OE #

|                 |                 |                 |                 |               |
|-----------------|-----------------|-----------------|-----------------|---------------|
| 45340 107 720 A | 45340 149 003 A | 45345 107 720 B | 45345 149 003 B | 45350 950 000 |
| 45340 107 721 A | 45340 149 720 A | 45345 107 721 B | 45345 149 720 B |               |
| 45340 107 722 A | 45340 950 000 A | 45345 107 722 B | 45350 107 720   |               |
| 45340 149 000 A | 45345 950 000 B | 45345 149 000 B | 45350 107 720 B |               |

# FA41 94.5 x 56mm



### YAMAHA

|              |       |           |
|--------------|-------|-----------|
| RD 250 E/F   | 78-79 | F&R       |
| XS 250 SE/SF | 79-81 | F         |
| RD 400 E/F   | 78-79 | F&R       |
| XS 400 SE    | 80-81 | F         |
| XS 750 SE    | 79-80 | F (Right) |

#### Competitor X Ref

| Dunlop | Ferodo | SBS | Vesrah |
|--------|--------|-----|--------|
| -      | FDB184 | 528 | VD215  |

#### Equivalents OE #

|               |              |
|---------------|--------------|
| 2G2 W0045 00  | 3J6 W0045 01 |
| 2R8 W0045 003 | 4W1 W0046 00 |
| 3H6 W0045 00  |              |

#### MATERIAL AVAILABILITY AND PART NO.

| STD  | OPTIONS |   |     |     |
|------|---------|---|-----|-----|
| FA   | HH      | R | MXS | GFA |
| FA41 | -       | - | -   | -   |

# FA42 45 x 45 x 10/16mm

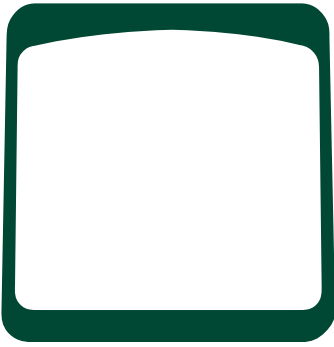

## YAMAHA

|           |       |   |
|-----------|-------|---|
| FS 1 DX   | 79-80 | F |
| RD 50 M   | 79-80 | F |
| RD 125 DX | 78-81 | F |
| RS 125 DX | 81    | F |
| RD 200 DX | 78-80 | F |

### Equivalents OE #

|              |              |
|--------------|--------------|
| 2R6 W0045 00 | 2R6 W0045 11 |
| 2R6 W0045 10 |              |

### Competitor X Ref

| Dunlop | Ferodo | SBS | Vesrah |
|--------|--------|-----|--------|
| -      | FDB248 | 531 | VD-213 |

### MATERIAL AVAILABILITY AND PART NO.

| STD  | OPTIONS |   |     |     |
|------|---------|---|-----|-----|
| FA   | HH      | R | MXS | GFA |
| FA42 | -       | - | -   | -   |

# FA43 46 x 21/11mm

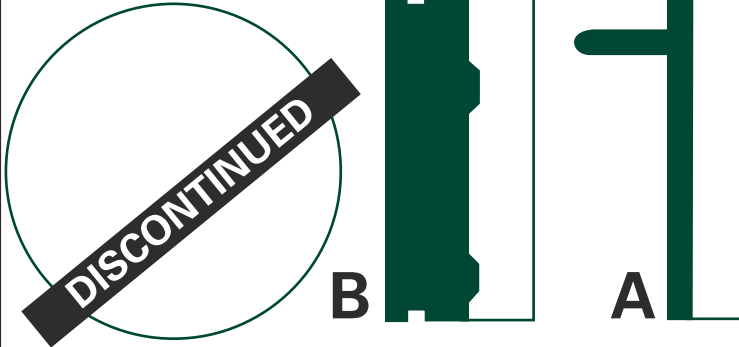

## HONDA

|              |       |   |
|--------------|-------|---|
| CB 125 K6/S2 | 76    | F |
| CB 200 B     | 76-79 | F |

### Equivalents OE #

|                 |
|-----------------|
| 45340 351 700 A |
| 45345 351 700 B |

### Competitor X Ref

| Dunlop | Ferodo | SBS | Vesrah |
|--------|--------|-----|--------|
| -      | -      | 521 | VD-110 |

### MATERIAL AVAILABILITY AND PART NO.

| STD | OPTIONS |   |     |     |
|-----|---------|---|-----|-----|
| FA  | HH      | R | MXS | GFA |
| -   | -       | - | -   | -   |

# FA45 54 x 53 x 11mm

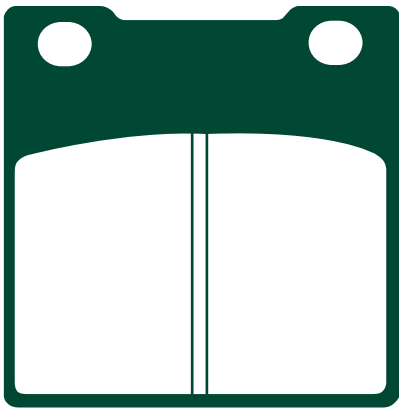

## HONDA

|                          |       |   |
|--------------------------|-------|---|
| CB 250 T/N/NA/NB/NDB/NDC | 78-82 | F |
| CB 250 RSA/RSD           | 81-84 | F |
| CM 250 TB                | 81    | F |
| CB 400 A 'Honda-matic'   | 79    | F |
| CB 400 T                 | 78    | F |
| CB 650 Z/B               | 79-81 | F |
| CB 750 KZ                | 80    | F |

### Equivalents OE #

|               |               |               |
|---------------|---------------|---------------|
| 45105 413 003 | 45105 425 003 | 45105 MA5 671 |
| 45105 413 305 | 45105 425 006 | 06455 425 405 |
| 45105 413 871 | 45105 471 006 |               |

### Competitor X Ref

| Dunlop | Ferodo | SBS | Vesrah    |
|--------|--------|-----|-----------|
| DP103  | FDB183 | 526 | VD113/117 |

### MATERIAL AVAILABILITY AND PART NO.

| STD  | OPTIONS |   |     |     |
|------|---------|---|-----|-----|
| FA   | HH      | R | MXS | GFA |
| FA45 | -       | - | -   | -   |

# FA46 44 x 11.5/13mm

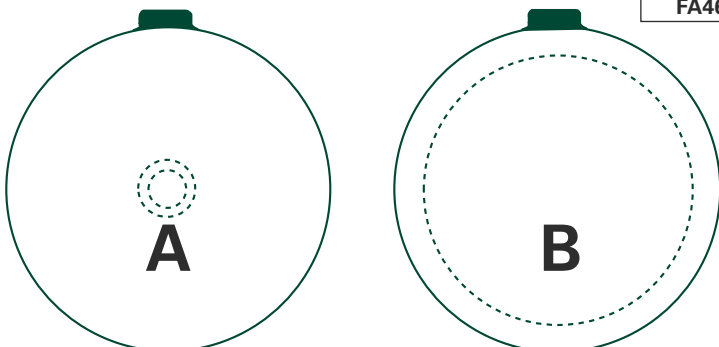

### MATERIAL AVAILABILITY AND PART NO.

| STD  | OPTIONS |   |     |     |
|------|---------|---|-----|-----|
| FA   | HH      | R | MXS | GFA |
| FA46 | -       | - | -   | -   |

## SUZUKI

|                  |       |   |
|------------------|-------|---|
| GP 100 C/N/X/DED | 78-87 | F |
|------------------|-------|---|

### Equivalents OE #

|             |
|-------------|
| 59300 39840 |
|-------------|

### Competitor X Ref

| Dunlop | Ferodo | SBS | Vesrah |
|--------|--------|-----|--------|
| -      | -      | 538 | VD-314 |

# FA47 40 x 58 x 7mm

## FA47/2 40 x 58 x 5.5mm

## FA47/3 40 x 58 x 9.3mm

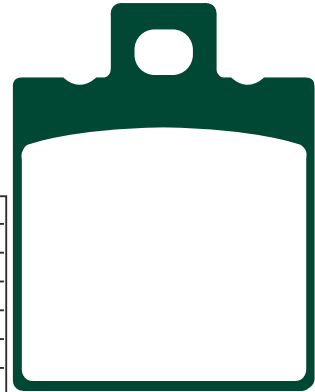

### Equivalents OE # - FA47

|         |            |                |               |               |              |
|---------|------------|----------------|---------------|---------------|--------------|
| 8103662 | 8113651    | 323 627        | 613 4007 71A  | 61340 311A    | 2547/F/S     |
| 8113016 | 8113662    | 326 446        | 43105 NN2 600 | 61340 281A    | 211082010    |
| 8113064 | 8213145    | 341 170        | 8000 46147    | 04700 2000037 | 000316546650 |
| 8113118 | 8213197    | 19654600       | 8000 90156    | 119 52200     | 00276546100  |
| 8113196 | 8213200    | 19654601       | 2525 242000   | 9021035000    | 107 28 86 30 |
| 8113222 | 19654600   | 491 13 409 044 | 8A00 46147    | 252524000     | 107 5365 13  |
| 8113323 | 8000 29070 | 3SH F5811 20   | 8000 46147    | 000276546100  | KA3496535    |
| 8113638 | 8000 39730 | 613 4008 1A    | 03613 9666    | 613 4 0541A   |              |

### Equivalents OE # - FA47/3

|               |               |
|---------------|---------------|
| 43105 KBS 405 | 43105 KY4 902 |
| 43105 KBS W00 | 43105 NW2 610 |
| 43105 KY4 901 |               |

### Competitor X Ref - FA47

| Dunlop | Ferodo              | SBS | Vesrah |
|--------|---------------------|-----|--------|
| DP601  | FDB207/R<br>/FDB705 | 519 | VD911  |

### Competitor X Ref - FA47/2

| Dunlop | Ferodo | SBS | Vesrah |
|--------|--------|-----|--------|
| -      | -      | 583 | -      |

### Competitor X Ref - FA47/3

| Dunlop | Ferodo | SBS | Vesrah  |
|--------|--------|-----|---------|
| -      | -      | 646 | VD911/2 |

| MATERIAL AVAILABILITY AND PART NO. |         |        |       |     |     |
|------------------------------------|---------|--------|-------|-----|-----|
| STD                                | OPTIONS |        |       |     |     |
| FA                                 | TT      | HH     | R     | MXS | GFA |
| FA47                               | FA47TT  | FA47HH | FA47R | -   | -   |

| MATERIAL AVAILABILITY AND PART NO. |         |         |     |     |
|------------------------------------|---------|---------|-----|-----|
| STD                                | OPTIONS |         |     |     |
| FA                                 | HH      | R       | MXS | GFA |
| FA47/2                             | -       | FA47/2R | -   | -   |

| MATERIAL AVAILABILITY AND PART NO. |         |   |     |     |
|------------------------------------|---------|---|-----|-----|
| STD                                | OPTIONS |   |     |     |
| FA                                 | HH      | R | MXS | GFA |
| FA47/3                             | -       | - | -   | -   |

### FA47

#### ACCOSSATO

CE 50/80/KR 80 87- F  
Enduro Codice 50 89- F

#### AGRALE

Elefantre 30.0 F

#### ALFER

80 MC 87- F  
125 MC 87 F  
125 MC 88- R  
250 MC 85-86 F  
250 MC 87 F&R  
250 MC 88- R  
250 GR/Enduro 85-87 F  
250 GR/Enduro 88- R  
300 GR Enduro 88- R

#### APRILIA

Classic 50 92-01 F  
AF1 Futura 50 90-92 F  
RS 50 93-98 F  
Europa 50 90-92 F  
AF1 125 87-89 R  
RS 125 (All models) 92-05 R  
AF 125 90-91 R  
Red Rose 125 87 R  
Tuono 125 03-04 R  
250 86 F  
RS 250 (All models) 95-02 R

#### BENELLI

124/125 2C/125 2T/2CSE 76- F  
125 T 83 F  
250 C/TS, 250/4 76- F  
304 83 F  
354 -82 F  
354 Sport 2 83 F&R  
500/4 76- F  
654 Sport 83 F&R  
666 Scooter "Born in Hell" 98-99 R

#### BERINGER

6 piston old design  
2 piston

#### BETA

Eikon 125/150 00-06 F

#### BIMOTA

All models 89-03 R  
Tesi 2D 04-06 R  
SB8K Gobert (996cc Suzuki engine) 06 R  
SB8K Santamonica (992cc Suzuki engine) R

### BREBMO

20 5185 11 (P32B) Single pad fixing 2 Piston  
20 5161 42 (P32F) Single pad fixing 2 Piston

### CAGIVA

Cucciolo 50 97 F  
W4 50 91-95 F  
Blues 125 92-95 R  
Cucciolo 125 00 F  
Frecia 125 SY 89 R  
NI 125 97 R  
Planet 125 99-03 R  
Supercity 125 92 R  
Mito 125 (all models) 91-07 R  
Raptor 125 03-07 R  
SST 250/350 80-82 F  
SX 250 82 F  
WMX 125 86 F  
WMX 250 -85 F  
Mito 500 91-92 r  
WMX 500 84-86 F  
Excaltiber 501 RX 92- R  
River 600 95-99 R  
650 Elephant 85- R  
650 Elephant 88-89 R

### DERBI

### DUCATI

Supersport 400 93-97 R  
400 Monster/Dark 95-04 R  
500 GTL 75 F  
500 GTV Pantah 77 F&R  
500 Sport Desmo 77 F&R  
500 Pantah 79 F&R  
600 Monster 93-99 R  
600 Monster Dark 98-99 R  
600 Monster City/City Dark 99 R  
600 Monster 00-01 R  
600 Supersport 91-97 R  
620/IE/SIE Monster 02-04 R  
620 Sport 03 R  
Monster 620 05-06 R  
S2R Dark (803cc) 06 R  
S2R (992cc) 06 R  
S4RS (998cc) 06 R  
Monster 620 Dark 03-06 R  
Multistrada 620 05-06 R  
695 Monster 06-07 R  
748 SP/Biposto 95-98 R  
748 Racing/SPS 98 R  
748 Biposto 99 R  
748 Racing 99 R

### DUCATI Contd.

748 SPS 99 R  
748 Biposto 00-02 R  
748 R/RS/S 00 R  
748 R 01-02 R  
748 RS 01 R  
748 S 01-02 R  
748 Testa Bassa 01 R  
748 E R  
750 Paso 87-90 R  
750 Supersport 91-98 R  
750 Monster 96-98 R  
750 Monster City/City Dark 99 R  
750 Monster/Monster Dark 99 R  
750 Monster 00-01 R  
Monster 800/IE/SIE 03-04 R  
800 Supersport 03 R  
Monster S2R (803cc) 05-07 R  
851 Superbike Biposto 89-92 R  
888 SP4/SP5 92-93 R  
888 Superbike Strada 94-95 R  
900 Supersport 89-90 R  
900 Supersport/Superlight 91-97 R  
900 Supersport CR USA 98 R  
900 Supersport FE 98 R  
900 Monster 93-99 R  
900 Monster Cromo/Special 98 R  
900 Monster City/City Dark 99 R  
900 IE Monster 00-01 R  
907 IE 90-93 R  
916 SP 94-96 R  
916 Biposto-Senna 94-98 R  
916 SPS (996cc) 98 R  
Monster S4 01-03 R  
996 98 R  
996 SPS/SPS II 99-00 R  
996 00 R  
996 S 01 R  
998 S 02 R  
998 R 02 R  
998 02-03 R  
Monster 1000 IE/SIE 03-05 R  
Monster 1000/1000 S4R 04-05 R  
S4R (998cc) Testastretta 07 R

### FANTIC

50 Caballero/Caballero RC 91- F  
80 Caballero/Caballero RC 91- F

### GILERA

RV 50 NGR 88- R  
125 HX LC 83- F  
125 RX 84- F



# FA47 Contd. 40 x 58 x 7mm

# FA47/2 Contd. 40 x 58 x 5.5mm

# FA47/3 Contd. 40 x 58 x 9.3mm

DISC PADS  
BUYERS GUIDE

### GILERA Contd.

|                              |       |   |
|------------------------------|-------|---|
| RX 125 Arizona               | 88-   | F |
| GFR 125                      | 94    | R |
| Nordwest                     | 94    | R |
| 125 CX                       | 91-   | R |
| 125 MX1/MXR                  | 89-   | R |
| 125 SP 01/SP 02              | 89-   | R |
| 125 XR1/XR2                  | 89-   | R |
| RX 200/Arizona/Enduro        | 85-   | F |
| 200 Fast Bike                | 87-   | R |
| RV 200                       | 85-86 | R |
| RV 200 ES                    | 87-   | R |
| HX 250 LC                    | 83-   | F |
| NGR 250                      | 85-   | R |
| 250 RX Arizona Rally         | 86-   | F |
| RC 250 Rally                 | 87-   | R |
| Saturno 350 Bialbero         | 90-   | R |
| XRT 350                      | 90-   | R |
| Nord-West 350                | 94-   | R |
| Saturno 500 S/Bialbero/Piuma | 90-   | R |
| XRT 600                      | 88-   | R |
| <b>HRD</b>                   |       |   |
| WH 125 Road/Red Horse        | 85-   | F |
| <b>HARRISON BILLET</b>       |       |   |
| Early design 4/6 piston      |       |   |
| <b>HONDA HM (Italy)</b>      |       |   |
| CRE 50 Six/Baja/Derapage     | 95-02 | R |
| <b>HYOSUNG</b>               |       |   |
| Grand Prix 125               | 99-04 | F |
| Exceed 125 (MS1 125/150)     | 02-04 | F |
| Boomer/Exceed 125            | 02-03 | F |
| MS1 125/150                  | 05    | F |
| <b>HUSQVARNA</b>             |       |   |
| XC 125                       | 85-86 | F |
| CR 240                       | 85-86 | F |
| CR 250                       | 85-86 | F |
| XC 250                       | 85-86 | F |
| CR 500                       | 85-86 | F |
| XC 500                       | 85-86 | F |
| TC 510                       | 87-88 | F |
| TE 510                       | 87-88 | F |
| TX 510                       | 87-88 | F |
| <b>ISR CALIPERS</b>          |       |   |
| 22-025-XX (4 piston)         |       | F |
| 22-027 (2 piston rear)       |       | F |
| 22-028 (2 piston)            |       | F |
| 22-029 (Rear 2 piston)       |       | F |

### KEEWAY

|                             |       |     |
|-----------------------------|-------|-----|
| ARN 125                     | 07    | F   |
| <b>KTM</b>                  |       |     |
| MX/MXC 125                  | 85    | F   |
| GSXC/GS 125                 | 85    | F   |
| MX/MXC/GS 125               | 86    | F&R |
| MX/MXC 250                  | 85    | F   |
| GSXC/GS 250                 | 85    | F   |
| MX/MXC/GS 250               | 86    | F&R |
| MX/MXC 300                  | 85    | F   |
| GSXC/GS 300                 | 85    | F   |
| MX/MXC/GS 300               | 86    | F&R |
| MX/MXC/GS 350               | 86    | F&R |
| 350 Four Stroke             | 83    | F   |
| MX/MXC/XC-GS 500            | 85    | F   |
| <b>LAVERDA</b>              |       |     |
| OR 50 Atlas                 | 87-   | F&R |
| GS 125 Lesmo                | 86-89 | F&R |
| LZ 125 Sport Brembo caliper | 80-82 | F   |
| Montjuic                    | 76    | F&R |
| Alpino 500                  | 76    | F&R |
| 650 All models              | 94-95 | R   |
| 668 All Models              | 96-98 | R   |
| 750 All Models              | 98-01 | R   |
| <b>MAICO</b>                |       |     |
| All Models                  | 85    | F   |
| <b>MALAGUTI</b>             |       |     |
| 50 Enduro MEX               | 85-86 | F   |
| Enduro MDX 80               | 84-   | F   |
| Ciak 125/150/200            | 01-07 | F   |
| F18 125/150 Warrior         | 00-03 | F   |
| <b>MALANCA</b>              |       |     |
| E2 C80/CS                   |       | F&R |
| 125 GTI                     |       | F&R |
| 125 Mark Enduro             | -84   | F   |
| Ciak 200                    | 06    | F   |
| <b>MONTESA</b>              |       |     |
| 311 (Honda) 260cc           | 92-93 | R   |
| 314R (Honda)                | 94-96 | R   |
| 315R (Honda)                | 97-00 | R   |
| <b>MOTO GUZZI</b>           |       |     |
| 350 up to 500 (All Models)  | 75    | F&R |
| 350 Nevada                  | 92-   | F&R |
| V35/V50/V65                 | 78-80 | F&R |
| 650 Florida                 | 92    | F&R |
| 750 SP                      | 92    | F&R |
| 750 T                       | 92-94 | F&R |

### MOTO GUZZI Contd.

|                                 |       |     |
|---------------------------------|-------|-----|
| 750 Nevada                      | 91-92 | F&R |
| 750 Nevada Club                 | 98-01 | F   |
| Daytona 1000                    | 93-97 | R   |
| Quota 1000                      | 93-95 | R   |
| V10 Centauro                    | 98-00 | R   |
| V11 (All models)                | 99-06 | R   |
| 1100 Sport/Sport Inj/VII        | 96-01 | R   |
| Griso                           | 04    | R   |
| <b>MOTO MORINI</b>              |       |     |
| Dart 350                        | 87    | R   |
| 350 Kanguro                     | 87    | R   |
| Excaliber 350/501 RLX           | 93-   | R   |
| <b>MZ/MUZ</b>                   |       |     |
| Tour/Traveller                  | 95-02 | R   |
| SkorpionSport/Replica/Cup       | 95-01 | R   |
| <b>PRO-ONE</b>                  |       |     |
| 2 Piston                        |       |     |
| <b>TM</b>                       |       |     |
| SMM 125 Black Dream (Rim brake) | 04-07 | R   |
| SMM 400 (4T) Rim brake          | 04-   | R   |
| SMM 530 F Black Dream Rim brake | 04-07 | R   |
| <b>VOXAN</b>                    |       |     |
| Charade Racing                  | 06    | R   |
| <b>YAMAHA</b>                   |       |     |
| TZR 125 RR                      | 96-   | R   |
| SZR 660                         | 96-97 | R   |
| <b>FA47/2</b>                   |       |     |
| <b>GARELLI</b>                  |       |     |
| Urka 50                         | 91-   | F   |
| 125 XR/XRD Tiger                | 83-   | F   |
| <b>GILERA</b>                   |       |     |
| 50 Rally                        | 87-   | F   |
| R1/50                           | 90-   | F   |
| <b>KTM</b>                      |       |     |
| 80 MX                           | 86-92 | F   |
| <b>FA47/3</b>                   |       |     |
| <b>HONDA</b>                    |       |     |
| NSR 125 FM/RK/RL/RM/RN/FP       |       |     |
| /RP/RR/RV/RW/RX/RY/R1           | 91-04 | R   |
| CRM 125 RL/RM/RN/RP/RR/RV/RX    | 90-99 | R   |

# FA48 46 x 44 x 16/11mm

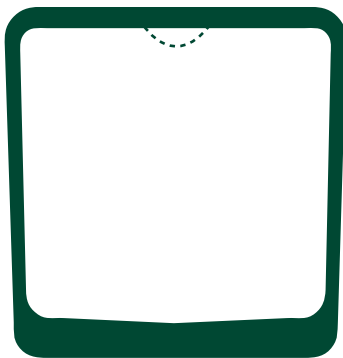

### KAWASAKI

|              |       |   |
|--------------|-------|---|
| KH 100 G2/G3 | 81-83 | F |
| Z 400 B1/B2  | 78-80 | F |

### Equivalents OE #

|              |            |
|--------------|------------|
| 43050 1007 A | 43050 5004 |
| 43050 1007 B |            |

### Competitor X Ref

| Dunlop | Ferodo | SBS | Vesrah |
|--------|--------|-----|--------|
| -      | FDB248 | 522 | VD-413 |

| MATERIAL AVAILABILITY AND PART NO. |         |   |     |     |
|------------------------------------|---------|---|-----|-----|
| STD                                | OPTIONS |   |     |     |
| FA                                 | HH      | R | MXS | GFA |
| FA48                               | -       | - | -   | -   |

# FA50 41.5 x 49 x 5.5mm



Equivalents OE # N/A

| Competitor X Ref | Dunlop | Ferodo | SBS    | Vesrah |
|------------------|--------|--------|--------|--------|
| -                | FDB213 | 532    | VD-912 |        |

| MATERIAL AVAILABILITY AND PART NO. |         |   |     |     |
|------------------------------------|---------|---|-----|-----|
| STD                                | OPTIONS |   |     |     |
| FA                                 | HH      | R | MXS | GFA |
| FA50                               | -       | - | -   | -   |

|                                    |       |   |
|------------------------------------|-------|---|
| <b>CASAL</b>                       |       |   |
| All disc models                    |       | F |
| <b>CIMATTI</b>                     |       |   |
| Gringo                             | -85   | F |
| <b>FANTIC</b>                      |       |   |
| 50 Strada Super Six                | 73-   | F |
| <b>HERCULES (SACHS)</b>            |       |   |
| Diff. older models with disc brake |       | F |
| 50 KX 5                            |       | F |
| 50 Ultra, RS Ultra                 |       | F |
| 80 Ultra, F Ultra, RS Ultra        |       | F |
| 80 Ultra Chopper                   |       | F |
| 80 Ultra AC                        |       | F |
| 80 Ultra AC Chopper                |       | F |
| 80 XE 9                            |       | F |
| <b>HOREX</b>                       |       |   |
| Rebell 80 N                        |       | F |
| Rebell 80 T                        |       | F |
| Sport 80 L                         |       | F |
| <b>MALAGUTI</b>                    |       |   |
| Chopper 25/40                      | -82   | F |
| 50 LX Sport                        | -82   | F |
| 50 Ronco RCW                       | -82   | F |
| 50 Fity HF                         | -82   | F |
| VA Olympique                       | -82   | F |
| 50 watercooled                     | -82   | F |
| 50 Grizzly RCX 10                  | 87-   | F |
| Chopper 80                         | -82   | F |
| <b>MALANCA</b>                     |       |   |
| 125/ST 54/GT 5                     |       | F |
| <b>PGO</b>                         |       |   |
| M 50 SP Spoke wheel                | 75-77 | F |
| M 50 SDP Cast Wheel                | 75-77 | F |

# FA51 78 x 50 x 11.5mm

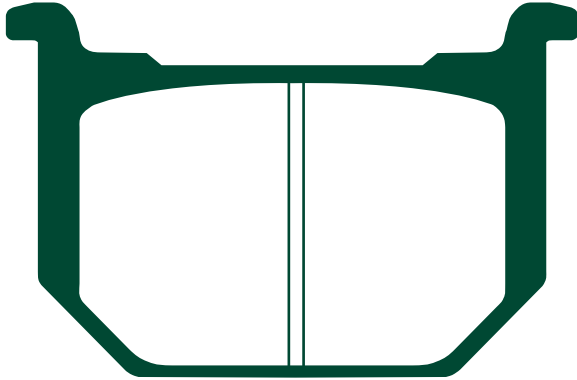

Competitor X Ref

| Dunlop | Ferodo | SBS | Vesrah |
|--------|--------|-----|--------|
| DP205  | FDB218 | 532 | VD-912 |

Equivalents OE #

|             |             |             |
|-------------|-------------|-------------|
| 59130 45230 | 59301 45850 | 59330 38310 |
| 59301 45810 | 59300 05810 |             |
| 59301 45811 | 59330 38300 |             |

## SUZUKI

|                                 |       |   |
|---------------------------------|-------|---|
| GN 250 F/J/M/R/T                | 85-97 | F |
| GS 250 TT/TX                    | 80-81 | F |
| GSX 250 ET/EX/EZ                | 80-82 | F |
| GN 400 TT                       | 80    | F |
| GSX 400 ET/EX/EZ                | 81-83 | F |
| GSX 400 LX/TX                   | 81    | F |
| GS 450 ET/EG/EJ                 | 80-88 | F |
| GS 700 EF/ESF                   | 85    | F |
| GSX 750 ESD/EFE/ESG/ESE/ESH/EFF | 82-86 | F |
| GSX 750 ET/EX                   | 80-81 | F |
| GS 850 GZ/GE/GG                 | 82-85 | F |
| GS 1000 GT/GX                   | 81-82 | F |
| GV 1200 GLF/GLF2/GLG Madura     | 85-86 | F |

## MATERIAL AVAILABILITY AND PART NO.

| STD  | OPTIONS |   |     |     |
|------|---------|---|-----|-----|
| FA   | HH      | R | MXS | GFA |
| FA51 | -       | - | -   | -   |

# FA52 41 x 21/11mm



## HONDA

|           |       |   |
|-----------|-------|---|
| CB 100 N  | 78-80 | F |
| CB 125 T2 | 79    | F |

Equivalents OE #

|               |               |
|---------------|---------------|
| 45340 399 700 | 45345 399 700 |
| 45340 399 701 | 45345 399 701 |
| 45340 399 702 | 45345 399 702 |

| MATERIAL AVAILABILITY AND PART NO. |         |   |     |     |
|------------------------------------|---------|---|-----|-----|
| STD                                | OPTIONS |   |     |     |
| FA                                 | HH      | R | MXS | GFA |
| FA52                               | -       | - | -   | -   |

Competitor X Ref

| Dunlop | Ferodo | SBS | Vesrah |
|--------|--------|-----|--------|
| -      | -      | 529 | VD119  |

# FA54 39.5 x 45 x 7.5mm

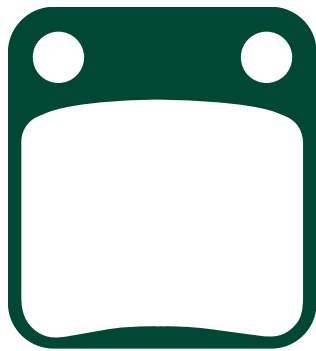

## HONDA

|                        |       |   |
|------------------------|-------|---|
| MB 5 S                 | 80-82 | F |
| MG 50 S/X/1/3 Magna 50 | 95-03 | F |
| MRX 50                 | 88-   | F |
| MBX 80 FWDD/FWDF       | 83-86 | F |
| CB 125 RS              | 83    | F |
| CBX 125 TS Custom      | 82    | F |
| CG 125 ES4             | 04-07 | F |
| CG 150 ESD Titan       | 04-05 | F |
| CG 150 KS/ES Titan     | 04-05 | F |
| CBX 200 Strada         | 97-01 | F |
| ATC 250 RB             | 81    | F |

## HYOSUNG

|             |       |     |
|-------------|-------|-----|
| TE 450 Quad | 06-07 | F&R |
|-------------|-------|-----|

## KAWASAKI

|  |       |   |
|--|-------|---|
| KX 65 A1/A2/A3/A4/A5/A6/A6F/A7F                      | 00-07 | R |
| KH 125 K1  | 83    | F |
| BN 125 A1/A2 'Eliminator'                            | 98-99 | F |
| KVF 300 A1/A2/A3/A4/B1/B2/B3/B4<br>(Prairie 4x4/2x4) | 99-02 | F |
| KVF 360 A1-A3/A6F/B1-B3/C1-C3/C6F Prairie            | 03-06 | F |
| KVF 400 A1/A2/B1 'Prairie'                           | 97-98 | F |
| KVF 400 C1/C2/C3/C4/D1/D2/D3/D4<br>(Prairie 4x4/2x4) | 99-02 | F |

## KEEWAY

|                 |    |   |
|-----------------|----|---|
| Dragon 250 Quad | 07 | R |
|-----------------|----|---|

## SUZUKI

|  |       |   |
|--|-------|---|
| RM 65 K3/K4/K5                               | 03-05 | R |
| DF 125                                       |       | F |
| DR 125 SF/SH/SJ                              | 85-94 | F |
| DR 125 SEX/SEY                               | 99-01 | F |
| TS 125 XUF/XUG/XUH/XUJ                       | 86-90 | F |
| DF 200 EV/EW/EY (SH42A)                      | 98-00 | F |
| DR 200 G/H/J                                 | 86-89 | F |
| DR 200 SEP/SER/SES/SEV/SEW/SEX/SEY (SH42A)   | 93-99 | F |
| DR 200 SE Trojan                             |       | F |
| DR 200 SEK1-SEK6                             | 01-05 | F |
| SX 200 R/R2/RJ/RM                            | 90-91 | F |
| LT-F 250 K2/K3/K4/K5/K6 Ozark                | 02-06 | F |
| TS 250 XE/XG/XH/XJ/XK                        | 85-89 | F |
| LT-A 400 FK2/FK3/FK4/FK5/FK6/FK7 Eiger 4WD   | 02-07 | F |
| LT-A 400 K2/K3/K4 Eiger                      | 02-04 | F |
| LT-F 400 FK2/FK3/FK4/FK5/FK6/FK7 (Eiger 4WD) | 02-07 | F |
| LT-F 400 K2/K3/K4/FK5/FK6/FK7 Eiger          | 02-04 | F |
| LT-A 500 FK2/FK3/FK4 Vinson 4WD Auto         | 02-07 | F |
| LT-F 500 FK3/FK4/FK5/FK6/FK7 Vinson          | 03-07 | F |

## YAMAHA

|   |       |   |
|---|-------|---|
| YFS 200 R/S/T/V Blaster                                       | 03-06 | F |
| YFM 250 XN/XP/XR/XS   | 01-04 | F |
| YFM 250 BT/BV/BW Big Bear                                     | 05-07 | F |
| YFM 350 XD/XE/XF/XG/XH/XJ/XK/XL/XM<br>/XN/XP/XR               | 92-03 | F |
| YFZ 350 U/B/D/E/F/G/H/J/K/L/M/N/P/R<br>/S/T/V Banshee         | 88-06 | F |
| YFM 350 FXG/FXH/FXJ/FXK/FXL/FXM/FXN<br>/FXP/FXR/FXS Wolverine | 95-04 | F |

### Competitor X Ref

|                        |                         |                   |                            |
|------------------------|-------------------------|-------------------|----------------------------|
| <b>Dunlop</b><br>DP107 | <b>Ferodo</b><br>FDB250 | <b>SBS</b><br>536 | <b>Vesrah</b><br>VD120/333 |
|------------------------|-------------------------|-------------------|----------------------------|

## YAMAHA Contd.

|                               |       |   |
|-------------------------------|-------|---|
| YFM 350 L Big Bear            | 99    | F |
| YFM 350 FAS/FAT/FAV Bruin 4x4 | 04-06 | F |
| YFM 350 ANS/ANT/ANV Bruin 2x4 | 04-06 | F |
| YFM 350 FGW Grizzly           | 07    | F |
| YFM 400 FAM/FAN               | 00-01 | F |
| YFM 400 FPR/FPS               | 03-04 | F |
| YFM 400 FWT (Big Bear)        | 05    | F |
| YFM 400 FGW Grizzly           | 07    | F |
| YFM 450 FAR/FAS               | 03-04 | F |
| YFM 450 FAT/FAHT/FAV (Kodiak) | 05-06 | F |
| YFM 450 FGW Grizzly           | 07    | F |

## CCM

|            |    |   |
|------------|----|---|
| C-XR 230 E | 07 | R |
| C-XR 230 S | 07 | R |

## DAELIM

|                         |       |     |
|-------------------------|-------|-----|
| Cordi 50/SE 50 R        | 04-07 | F   |
| Altino 125              | 01-04 | F   |
| Otello 125 (NS 125 DLX) | 00-02 | F   |
| NS 125 DLX/III          | 03-07 | F&R |
| History 125             | 01-06 | F&R |
| Tapo Message 50         | 04    | F   |

## GARELLI

|              |    |   |
|--------------|----|---|
| Fashion F150 | 07 | F |
|--------------|----|---|

## HUSQVARNA

|           |       |   |
|-----------|-------|---|
| TC/TE 610 | 92-94 | R |
|-----------|-------|---|

## JIALING

|                   |    |   |
|-------------------|----|---|
| JH 125 B Roadstar | 98 | F |
|-------------------|----|---|

## TAISHAN

|          |       |   |
|----------|-------|---|
| XT 50    | 03-04 | F |
| Sport 50 | 03-04 | F |
| CT 125   | 04    | F |

## PGO

|                      |       |   |
|----------------------|-------|---|
| BR 150 A Bugxter     | 04-06 | R |
| Bugrider 50 (Buggie) | 06    | R |

## SACHS

|             |       |   |
|-------------|-------|---|
| X Road      | 07    | R |
| Mad Ass 50  | 06-07 | R |
| Mad Ass 125 | 06-07 | R |

## SYM

|                |    |   |
|----------------|----|---|
| Quadraider 600 | 06 | F |
|----------------|----|---|

### Equivalent OE #

|                   |                |
|-------------------|----------------|
| 43082 1241        | 59340 22A00    |
| 43082 0043        | 59340 42A10    |
| 45105 166 007     | 59340 44A00    |
| 45105 GE3 601     | 3GD W0045 00   |
| 45105 GE3 602     | 06455 GBF J01  |
| 45105 GC4 601     | 5LP W0045 00   |
| 45105 GC4 602/603 | 59100 38870    |
| 45105 GW6 004     | 59100 38880    |
| 45105 GBF 405     | 59101 38810    |
| 45112 GC4 601     | 59101 38820    |
| 45112 GC4 831     | 59101 38850    |
| 800070854         | 59101 38860    |
| 43082 1028        | K4308 21241    |
| 43082 1201        | 06455 KEH 900  |
| 59300 44870       | 06455 GBZ 701  |
| 59300 42810       | 06455 KRM 861  |
| 59300 42850       | 55100 23044 08 |
| 59340 13A00       |                |

| MATERIAL AVAILABILITY AND PART NO. |         |       |       |     |
|------------------------------------|---------|-------|-------|-----|
| STD                                | OPTIONS |       |       |     |
| FA                                 | HH      | R     | MXS   | GFA |
| FA54TT                             | FA54HH  | FA54R | MXS54 | -   |

# FA55 50 x 12/9mm

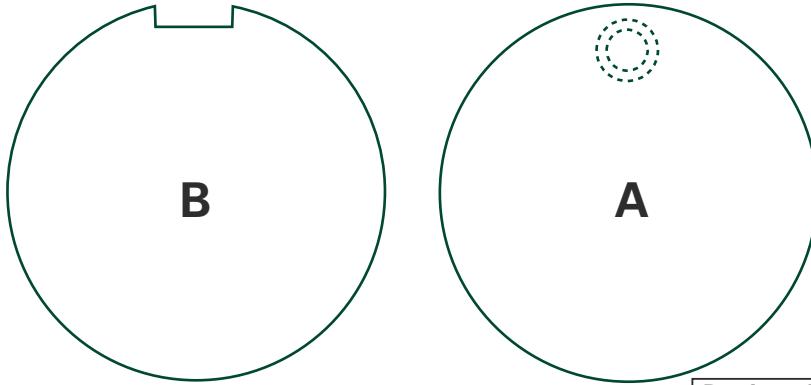

## KAWASAKI

|               |       |   |
|---------------|-------|---|
| HID/E/F       | 73-75 | F |
| Z 900 ZIA/ZIB | 74-76 | F |

## SUZUKI

|                     |       |   |
|---------------------|-------|---|
| GT 125 L/M/A/B      | 76-79 | F |
| GT 185 (All Models) | 73-79 | F |
| GT 250 (All Models) | 73-78 | F |
| GT 380 (All Models) | 73-77 | F |
| RE5 M/A             | 75-77 | F |
| GT 500 A/B          | 75-78 | F |
| GT 550 K/L/M/A/B    | 73-77 | F |
| GT 750 K/L/M/A/B    | 73-77 | F |

### Competitor X Ref

| Dunlop    | Ferodo | SBS | Vesrah                            |
|-----------|--------|-----|-----------------------------------|
| DP200/201 | -      | 503 | VD301/302<br>/303/304/<br>401/402 |

### Equivalents OE #

|               |             |             |
|---------------|-------------|-------------|
| 59100 18840   | 59100 31831 | 43082 001   |
| 59100 18841   | 43050 001   | 59300 18810 |
| 59100 36830/1 | 43050 002   | 59300 36840 |
| 59100 39810   | 43051 001   |             |
| 59100 31830   | 43071 001   |             |

| MATERIAL AVAILABILITY AND PART NO. |         |   |     |     |
|------------------------------------|---------|---|-----|-----|
| STD                                | OPTIONS |   |     |     |
| FA                                 | HH      | R | MXS | GFA |
| FA55                               | -       | - | -   | -   |

# FA56 43.5 x 8mm



## SUZUKI

|                |       |   |
|----------------|-------|---|
| GP 125 C/N/X/D | 78-84 | F |
|----------------|-------|---|

## HYOSUNG

|                    |       |   |
|--------------------|-------|---|
| GF/A 125 'Speed'   | 99-06 | F |
| Cruise II GA 125 F | 99-04 | F |

## KREIDLER

|                      |  |   |
|----------------------|--|---|
| 50 RS-G/RSH-G and GS |  | F |
| 80 E/L Florett       |  | F |
| 125 RS               |  | F |

## LIFAN

|           |  |   |
|-----------|--|---|
| LT 125-3A |  | F |
|-----------|--|---|

## MOTO ROMA

|         |    |   |
|---------|----|---|
| MXR 125 | 03 | F |
|---------|----|---|

## SUPERBYKE

|            |  |   |
|------------|--|---|
| R-SR125 4V |  | F |
|------------|--|---|

### Equivalents OE #

|             |             |
|-------------|-------------|
| 59300 39820 | 59340 39100 |
| 59300 39821 | 59330 39100 |
| 59302 39870 |             |

### Competitor X Ref

| Dunlop | Ferodo | SBS | Vesrah |
|--------|--------|-----|--------|
| -      | -      | 524 | VD-312 |

| MATERIAL AVAILABILITY AND PART NO. |         |   |     |     |
|------------------------------------|---------|---|-----|-----|
| STD                                | OPTIONS |   |     |     |
| FA                                 | HH      | R | MXS | GFA |
| FA56                               | -       | - | -   | -   |

# FA57 55.7 x 53 x 9mm

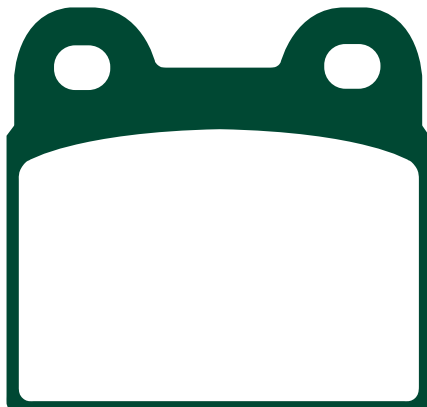

## BMW

|           |       |   |
|-----------|-------|---|
| R 45/45 N | 78-85 | F |
| R 45 T    | 80-85 | F |
| R 65 LS   | 81-85 | F |
| R 65 T    | 80-85 | F |

### Equivalents OE #

|                 |
|-----------------|
| 34 71 2 301 359 |
| 34 11 1 238 083 |

### Competitor X Ref

| Dunlop | Ferodo | SBS | Vesrah |
|--------|--------|-----|--------|
| -      | -      | 527 | VD-935 |

| MATERIAL AVAILABILITY AND PART NO. |         |   |     |     |
|------------------------------------|---------|---|-----|-----|
| STD                                | OPTIONS |   |     |     |
| FA                                 | HH      | R | MXS | GFA |
| FA57                               | -       | - | -   | -   |

# FA58 USE FA161

## FA59 32 x 18.8mm



### BENELLI

254 83 F

### CAGIVA

XSST 125 -80 F  
SST 250 -80 F

#### Competitor X Ref

| Dunlop | Ferodo | SBS | Vesrah |
|--------|--------|-----|--------|
| -      | -      | -   | -      |

#### Equivalents OE #

N/A

#### MATERIAL AVAILABILITY AND PART NO.

| STD | OPTIONS |   |     |     |
|-----|---------|---|-----|-----|
| FA  | HH      | R | MXS | GFA |
| -   | -       | - | -   | -   |

## FA60 35.2 x 51.5 x 6mm

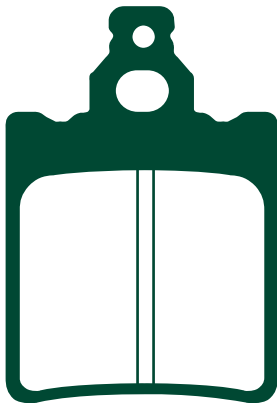

#### Competitor X Ref

| Dunlop | Ferodo | SBS | Vesrah     |
|--------|--------|-----|------------|
| DP611  | FDB694 | 574 | VD-920/937 |

#### Equivalents OE #

|            |             |            |
|------------|-------------|------------|
| 8113104    | 8213051     | 326 478    |
| 8000 33545 | 8213104     | 8000 40413 |
| 8000 37009 | 238 076570  |            |
| 8000 40413 | 245 07 6340 |            |

#### MATERIAL AVAILABILITY AND PART NO.

| STD  | OPTIONS |   |     |     |
|------|---------|---|-----|-----|
| FA   | HH      | R | MXS | GFA |
| FA60 | -       | - | -   | -   |

### APRILIA

Europa 50 90-92 R  
AF1 Futura 50 90-92 R  
MX 50 03-05 R  
RS 50 93-06 R  
RX 50 C/CD 93-04 R  
Tuorno 50 03-04 R  
RX 50 Raing 03-06 R  
RX3-5 Marce (M/N/P/R) 91-94 R

### KEEWAY

X Ray 50 Supermoto 06 R

### MOTO GUZZI

250 (All Models) 75- F

### CAGIVA

W4 50 91-95 R  
WSXT 125 "Aletta Rossa" 83-84 F  
XSST 125 81-82 F  
SXT 125 82- F  
W8 125 93-98 R

### FANTIC

50 Caballero/Caballero RC 91- R  
50.1 Oasis 86- R  
50.1 Oasis E.S. 87- R  
50 Kaloa F&R  
80 Caballero/Caballero RC 91- R  
80 Kaloa F&R

### GARELLI

125 Tiger XLE 86- R  
GTA 125 85 F  
GTA 125 86- F&R

### GENERIC

Trigger X50 06-07 R  
Trigger SM 50 06-07 R

### GILERA

RV 50 NGR 88- F  
NGR 250 85- F

### LAVERDA

LB 125 Custom/Sarbia/Strada Sport 85-87 F

### MALAGUTI

50 MXR 89- F

### MALANCA

125 ob one M6 85- F&R  
125 ob one M6 Racing 85- F&R  
125 Mark Enduro 85- F

# FA61 94.5 x 56mm Tapered 1 Left/1Right



## YAMAHA

XJ 650 G/H/J/K Maxim  
XJ 650 LH Midnight  
XS 750 SE  
XV 750 SE

80-83 F  
81 F  
79-80 F(left)  
81 F

### Competitor X Ref

| Dunlop | Ferodo | SBS | Vesrah |
|--------|--------|-----|--------|
| -      | FDB247 | 545 | VD-216 |

### Equivalents OE #

|              |              |              |
|--------------|--------------|--------------|
| 2G2 W0045 01 | 3J6 W0045 11 | 4H7 W0045 12 |
| 2G2 W0045 10 | 4H7 W0045 00 | 4W5 W0045 00 |
| 3J6 W0045 10 | 4H7 W0045 10 |              |

| MATERIAL AVAILABILITY AND PART NO. OPTIONS |    |   |     |     |
|--|----|---|-----|-----|
| STD  | HH | R | MXS | GFA |
| FA61                                       | -  | - | -   | -   |

# FA62 51.3 x 11mm

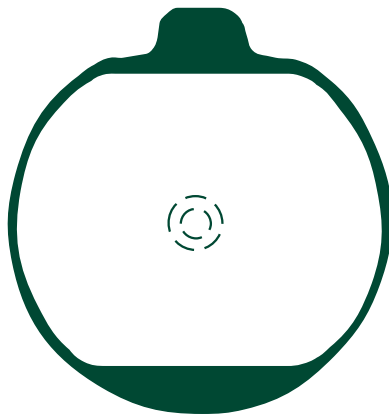

## KAWASAKI

Z 1000 ST (E1/E2 shaft) 79-82 F  
Z 1300 A1-A5 79-83 F  
ZG 1300 A1-A3 84-86 F

### Competitor X Ref

| Dunlop | Ferodo | SBS | Vesrah |
|--------|--------|-----|--------|
| DP303  | FDB220 | 530 | VD-423 |

### Equivalents OE #

|            |
|------------|
| 43082 1004 |
| 43082 1058 |

| MATERIAL AVAILABILITY AND PART NO. OPTIONS |    |   |     |     |
|--|----|---|-----|-----|
| STD  | HH | R | MXS | GFA |
| FA62                                       | -  | - | -   | -   |

# FA63 52.6 x 53 x 9mm

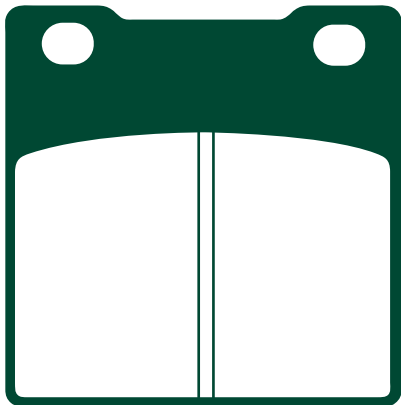

## HYOSUNG

Comet 250/600 02 R

## MAGNI

Sport 1200 'S' 01 R

## SUZUKI

|   |       |     |
|---|-------|-----|
| GSF 250 N/ZM/P/NP/ZP/N/NR   | 92-96 | R   |
| GSF 250 VS/S Bandit   | 97    | R   |
| GSX 250 R CH/H (GJ72A)  |       | R   |
| GSX 250 SSM Katana (GJ76A)  | 91    | R   |
| GSXR 250 J (GJ72A)  |       | R   |
| GSXR 250 CK   |       | R   |
| GSXR 250 RK (GJ73A)   | 89    | R   |
| RG 250 WD 'Gamma'   | 83    | F&R |
| RG 250 WE/FG/CH/FCH/FH 'Gamma'  | 84-88 | R   |
| RGV 250 J/K/L   | 88-90 | R   |
| TV 250 J/K/AK/L (VJ21A) Wolf  | 88-90 | R   |
| SG 350 N 'Goose'  | 92    | R   |
| GSXR 400 H  | 87    | R   |
| GSXR 400 J/RR/RAK (GK73A)   | 88-90 | R   |
| GSXR 400 RL/RM/RN/RS (GK76A)  | 90-95 | R   |
| GSF 400 All models (Bandit)   | 89-97 | R   |
| GSX 400 R2/RG (GK71B/F)   |       | R   |
| GSX 400 X/XA/XS Impulse   |       | R   |
| GSX 400 FJ/FK/FAK/FL (GK74A)  | 88-90 | R   |
| GSX 400 R/S/T/ZR/ZS/ZT/X Impulse Type S   | 94-99 | R   |
| GSX 400 FW/FWS/FWS-2  |       | F&R |
| GSX 400 SSN (GK77A) Katana  | 92    | R   |
| GSX 400 FSV/FSK1 (GK7B) Inazuma   | 00    | R   |
| RF 400 RP/RR/VR/RT/RVT/RV-V (GK78A)   | 93-97 | R   |
| RG 400 EWF/EW-2G/EWH Walter Wolf (Type 1&2)   | 85-87 | R   |
| GS 500 EK/EL/EM/EN/EP/ER/ES/ET/EV/EW/EX<br>/EY/K1/K2/K3/FK4/K4/FK5/K5/FK6/K6/K7/FK7 | 89-07 | R   |
| RG 500 G/CH   | 85-87 | R   |
| GSX 550 ESD/ESE/EFE/EFF/ESH/EFG   | 84-87 | F&R |
| GSX 600 FJ/FK/FL/FM/FN/FP/FR/FS/FT/FV   | 88-97 | R   |
| GSX 600 FW/FX/FY/FK1/FK2/FK3/FK4/FK5/FK6  | 98-06 | R   |
| GSF 600 S/T/ST/V/SV/W/SW/X/SX/SY/Y/K1/SK1<br>/K2/SK2/K3/SK3/K4/SK4 "Bandit"         | 95-04 | R   |
| RF 600 RP/RR/RS/RT/RV   | 93-97 | R   |
| GSXR 600 V/W/X/Y/K1/K2/K3/ZK3   | 97-03 | R   |
| SV 650 X/Y/K1/K2  | 99-02 | R   |
| SV 650 SX/SY/SK1/SK2  | 99-01 | R   |
| GSX 750 SE "Katana"   | 85    | F   |
| GSX 750 FK/FL/FM/FN/FP/FR/FS/FT/FV  | 89-97 | R   |
| GSX 750 RG  | 89    | R   |
| GSX 750 FW/FX/FY/FK1/FK2/FK3/FK4/FK5/FK6  | 98-06 | R   |
| GSX 750 W/X/Y/K1  | 98-03 | R   |
| GSXR 750 F/G/H/J/K/L/M/WN/WR/WS<br>/TN/W/X/Y/K1/K2/K3                               | 85-00 | R   |
| GSXR 750 RG   | 86    | R   |
| RF 900 RT/RV/RW   | 96-98 | R   |
| TL 1000 SV/SW/SX/RW/RX/SY/RZ/SK1/RK1  | 97-02 | R   |
| GSXR 1100 G/H/J/K/L/M/N   | 86-92 | R   |
| GSXR 1100 WP/WR/WS/WT   | 93-96 | R   |
| GSF 1200 T/ST/V/SV/S/SW/X/SX/SY/SK1/K1<br>/K2/SK2/K3/SK3/K4/SK4/K5/SK5 'Bandit'     | 96-05 | R   |
| GSF 1200 SAV ABS-Bandit   | 97    | R   |
| GSX 1200 FSW/FSX 'Inazuma'  | 98-99 | R   |
| GSX 1300 RX/RZ/RK1/RK2/RZK3/RK3<br>/RK4/RK5/K6/K7 'Hayabusa'                        | 99-07 | R   |

### Equivalent OE #

|             |             |             |
|-------------|-------------|-------------|
| 59130 16700 | 69100 05870 | 69100 21820 |
| 59130 16720 | 69130 16700 | 69130 27A10 |
| 59130 16730 | 69130 16740 | 69130 30B21 |
| 59130 16740 | 69130 20A10 | 69130 33C00 |
| 59130 16750 | 69130 21E00 | 69130 21820 |
| 59130 16810 | 69100 05830 | 69130 34C00 |
| 59130 30B00 | 69100 05860 | 69100 34860 |
| 59130 30B10 | 69100 05890 | 69101 05820 |
| 59130 30B20 | 69100 06810 | 69100 05890 |
| 59130 30B21 | 69100 20810 | 69100 0BE00 |

### Competitor X Ref

| Dunlop | Ferodo   | SBS | Vesrah |
|--------|----------|-----|--------|
| DP207  | FDB338/R | 556 | VD-327 |

### MATERIAL AVAILABILITY AND PART NO.

| STD  | OPTIONS |   |     |     |
|------|---------|---|-----|-----|
| FA   | HH      | R | MXS | GFA |
| FA63 | FA63HH  | - | -   | -   |

# FA64 65.3 x 59 x 10mm

**YAMAHA**  
RD 250/350 LC

80 F

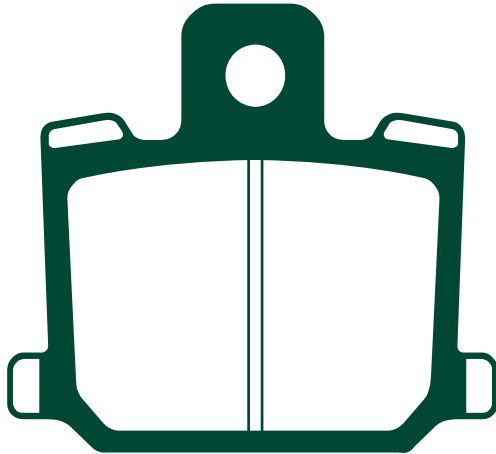

### Equivalents OE #

|              |              |
|--------------|--------------|
| 4LO W0045 00 | 4KO W0045 00 |
| 4LO W0045 10 | 4KO W0045 10 |

### Competitor X Ref

| Dunlop | Ferodo | SBS | Vesrah |
|--------|--------|-----|--------|
| -      | -      | 535 | VD-221 |

### MATERIAL AVAILABILITY AND PART NO.

| STD  | OPTIONS |   |     |     |
|------|---------|---|-----|-----|
| FA   | HH      | R | MXS | GFA |
| FA64 | -       | - | -   | -   |

# FA65 71.6 x 45.2 x 11.5mm

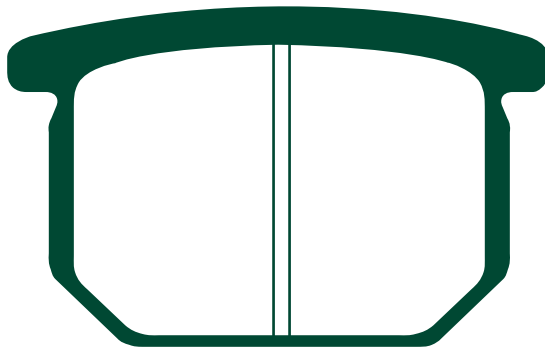

### SUZUKI

|  |       |   |
|--|-------|---|
| GS 550 ET/EX/EZ/LT/LX/MX/MZ                | 80-84 | F |
| GR 650 D/XD Tempter                        | 83    | F |
| GS 650 GTX/GTZ/GTD/GX/GZ                   | 81-83 | F |
| GSX 750 S/SS (G57SX-106815-) Katana        | 84    | F |
| GSX 750 S-2/S-2C<br>(GS75X-114747-) Katana | 84    | F |
| XN 85 Turbo                                | 83    | F |
| GS 1000 ET                                 | 81    | F |
| GSX 1000 SZ 'Katana'                       | 82    | F |
| GSX 1100 ET/EX/EZ/ESD                      | 80-83 | F |
| GS 1100 GZ                                 | 82    | F |
| GSX 1100 SZ/SD 'Katana'                    | 82-83 | F |

### Competitor X Ref

| Dunlop | Ferodo | SBS | Vesrah |
|--------|--------|-----|--------|
| DP206  | FDB217 | 534 | VD-324 |

### MATERIAL AVAILABILITY AND PART NO.

| STD  | OPTIONS |   |     |     |
|------|---------|---|-----|-----|
| FA   | HH      | R | MXS | GFA |
| FA65 | -       | - | -   | -   |

### Equivalents OE #

|             |             |
|-------------|-------------|
| 59300 49820 | 59300 49850 |
| 59300 49821 |             |

# FA66 USE FA68



**FA67 B. 85 x 43 x 8mm**

**A. 55.5 x 37 x 10mm**

**FA67/2 B. 85 x 43 x 6.2mm**

**A. 55.5 x 37 x 8.5mm**

**FA67/3 B. 85 x 43 x 7mm**

**A. 55.5 x 37 x 9mm**

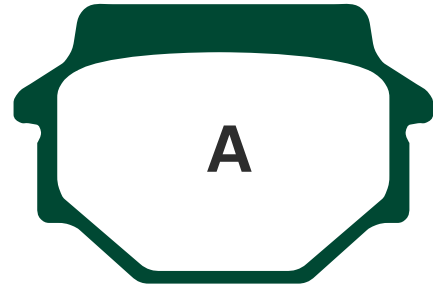
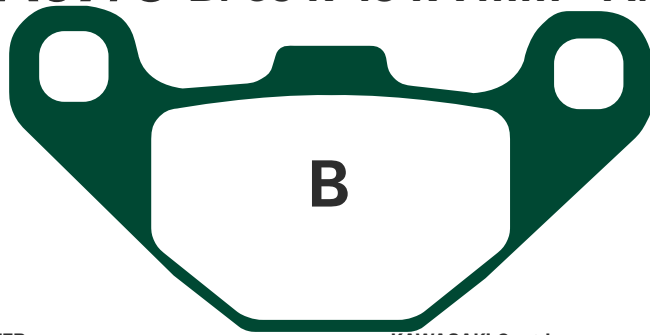

|  |       |     |   |       |     |  |          |   |
|--|-------|-----|---|-------|-----|--|----------|---|
| <b>ALFER</b><br>AR 250                 | 93-   | R   | <b>KAWASAKI Contd.</b><br>GPZ 305 B1-B10/A1 | 83-96 | F   | <b>SUZUKI</b><br>RB 50 H 'GSXR 50'               | 87       | F |
| <b>BAROSSA</b><br>170 Cheetah          | 03-06 | R   | ZR 400 A1/B1 (Z 400F)                       | 83-84 | F   | RG 50 EW   |          | F |
| 250 Cheetah                            | 03-06 | R   | Z 400 C2/C3 (Z400 F2)                       | 85-87 | F   | OR 50 ET   | 80       | F |
| <b>CAGIVA</b><br>WMX 125/250           | 89    | R   | ZL 400 B 'Eliminator' 400 SE                | 88    | F   | ZR 50 SLKX                                       | 81       | F |
| <b>DERBI</b><br>DXR 200                | 04-07 | R   | FX 400 R (ZX 400 E1-E3)                     | 86-88 | F   | ZR 50 SKX/SKE/SKH                                | 83-87    | F |
| DXR 250                                | 04-07 | R   | GPZ 400 R (ZX 400 D/D3/D3A)                 | 85-87 | F   | GN 125 Z/M/R/V/W/X/Y/K1                          | 94-01    | F |
| <b>GAS-GAS</b><br>80/125 Enduro        | 94-95 | R   | GPZ 500 S (EX 500 B1-B5)                    | 88-93 | F   | GS 125 ESZ                                       | 82       | F |
| MX 80                                  | 96    | R   | GPZ 500 S (EX 500 E1-E10)                   | 94-03 | R   | GS 125 ESR/ESX                                   | 95-00    | F |
| <b>GOES</b><br>Goes 220                | 05-06 | R   | KX 500 A1/A2/B1                             | 83-85 | F   | X4 125   |          | F |
| <b>KTM</b><br>125/250/350/500 MX       | 89-91 | F&R | KX 500 B2                                   | 86    | F&R | GSX 250 FXK2                                     | 02       | R |
| 125/250/300/500 MX                     | 92-93 | R   | KX 500 C1/D1                                | 87-88 | R   | GSX 400 FX/FZ/FD                                 | 81-83    | F |
| 125/250/300/600 Enduro                 | 92-93 | R   | ZR 550 A1/A2 (Z 550F)                       | 83-84 | F   | <b>TGB</b><br>250 Blade/Congo ATV                | 06-07    | F |
| 250/300 E/XC/GS                        | 90-91 | R   | GT 550 G1-G9                                | 83-01 | F   | <b>FA67/2 - FANTIC</b><br>50 Strada              | 82-      | F |
| EXC/020/EGS/620 SX                     | 94-95 | R   | KLR 600 A1/A2/B1-B4/86-89                   | 84-94 | F   | 50/50.1 Raider                                   | 81-      | F |
| <b>KAWASAKI</b><br>KSR 1 (KMX50 B1/B2) | 90-91 | R   | KL 650 B1/B2/B3 "Tengai"                    | 89-92 | R   | <b>HERCULES (SACHS)</b><br>50 Supra 4 GP         |          | F |
| KSR 11 (KMX80 B1/B2)                   | 90-91 | R   | KL 650 C1-C10                               | 95-04 | R   | <b>MALAGUTI</b><br>50 MDX Gold Enduro            | 87-      | F |
| KH 100 G4-G8 (EX)                      | 83-87 | F   | <b>KTM</b><br>MX 125                        | 89-91 | F&R | 50 Enduro MEX                                    | 87-      | F |
| AR 125 A1-A7/B1-B8                     | 82-94 | F   | MX 125                                      | 92-93 | R   | 50 Enduro MSX                                    | 85-      | F |
| KH 125 K2-K10                          | 82-98 | F   | EXC 125                                     | 89    | F&R | <b>QUADZILLA</b><br>Stinger R 250 E              | 06       | R |
| KH 125 L1 (EX)                         | 84    | F   | D-XC/E-XC/E-GS 125                          | 90-91 | F&R | 250 E  | 06       | R |
| KMX 125 A1-A5/B1-B12                   | 86-03 | R   | D-XC/E-XC/E-GS 125                          | 92-93 | R   | 300 SE 4 Valve                                   | 06-07    | R |
| KX 125 B2/C1/D1                        | 83-85 | F   | MX 250                                      | 89-91 | F&R | 4 Cross 200 E SUV                                | 06-07    | R |
| KX 125 E1                              | 86    | F&R | MX 250                                      | 90-91 | F&R | ST 200 E (5 Speed Manual)                        | 06-07    | R |
| KX 125 E2/F1                           | 87-88 | R   | EXC/EGS 250                                 | 89    | F&R | <b>FA67/3 - KAWASAKI</b><br>KLE 250 A2 (Anhelio) | 95       | R |
| KMX 200 A2/A3                          | 88-92 | R   | D-XC/E-XC/E-GS 250                          | 91    | F&R | KLE 250 A3/A5/A6                                 | 97/00-01 | R |
| KDX 200 C1-C3/E1-E4                    | 86-92 | F   | D-XC/E-XC/T-XC/E-GS 250                     | 92-93 | R   | ZZR 250 (EX 250 H1-H13)                          | 90-03    | R |
| Z 200 A6                               | 83    | F   | MX 350                                      | 89-91 | F&R | ZXR 250 C1-C3                                    | 91-93    | R |
| BJ 250 B1-B7A 'Estrella'               | 92-99 | F&R | DXC/EXC/EGS 350                             | 90-91 | F&R | ZXR 250 R/SP/D1                                  | 91       | R |
| BJ 250 C1-C7 Estrella RS               | 95-01 | F&R | EXC 350                                     | 89    | F&R | ZR 250 A1-A5                                     | 91-95    | R |
| KL 250 J1-J3 Stockman                  | 00-02 | F   | MX 500                                      | 92-94 | R   | ZR 400 D1/D3/D4 'Xanthus'                        | 92-95    | R |
| KLX 250 G1/G1A Super Sherpa            | 97    | R   | LC-4 MX 500                                 | 90-91 | F&R | GPZ 500 S (EX 500 D1-D7)                         | 94-01    | R |
| KR 250 A1/A2                           | 84-86 | F   | LC-4 EXC 500                                | 90-91 | F&R | KLE 500 A1-A12                                   | 91-04    | R |
| KX 250 C1/C2/D1                        | 83-85 | F   | LC-4 MX/EXC 600                             | 90-91 | F&R | KLE 500 B1/B1P/B6F                               | 05-06    | R |
| KX 250 D2                              | 86    | F&R | LC-4 EXC 600                                | 92-93 | R   | KLR 650 A1-A10                                   | 87-89    | R |
| KX 250 E1/F1                           | 87-88 | R   | LC-4 EXC 600                                | 92-93 | R   | <b>KRAM-IT (KRAMER)</b><br>ER 125/250/300 RV3    | 88-      | R |
| KLR 250 D2-D22                         | 84-05 | F   | LC-4 EXC 600                                | 94-   | R   | ER 500/600                                       | 96-      | R |
| KLX 250 H1 'Super Sherpa'              | 98    | R   | LC-4 EXC 600                                |       |     |  |          |   |
| EL 252 (EX 250 F2/F3)                  | 97-03 | F   | LC-4 EXC 600                                |       |     |  |          |   |
| ZR 250 B6 Balius-II                    | 02    | R   | LC-4 EXC 600                                |       |     |  |          |   |
| KLF 300 B1-B17 "Bayou"                 | 88-04 | F   | LC-4 EXC 600                                |       |     |  |          |   |

**Equivalents OE # - FA67**

|            |            |               |             |               |             |
|------------|------------|---------------|-------------|---------------|-------------|
| 43050 1063 | 43082 1063 | 43082 1163    | 59130 26820 | 59300 36821   | K4308 21204 |
| 43050 1064 | 43082 1064 | 43082 1191    | 59300 04830 | 59300 36822   | 513506      |
| 43050 1073 | 43082 1070 | 43082 1204    | 59300 04831 | 59300 36871   | 00Q25001198 |
| 43050 1082 | 43082 1073 | 43082 120     | 59300 26820 | 59301 39810   |             |
| 43082 1027 | 43082 1084 | 45815 RAM 000 | 59300 33810 | 59301 39811   |             |
| 430821031  | 43082 1086 | 59100 33810   | 59300 36810 | 59301 39812   |             |
| 43082 1051 | 43082 1092 | 59100 33812   | 59300 36811 | 59301 33810   |             |
| 43082 1056 | 43082 1096 | 59100 33820   | 59300 36820 | 545 13209 044 |             |

**Equivalents OE # - FA67/2**

238 07 6340    240 07 6340

**Competitor X Ref**

|               |               |            |               |
|---------------|---------------|------------|---------------|
| <b>Dunlop</b> | <b>Ferodo</b> | <b>SBS</b> | <b>Vesrah</b> |
| DP310         | FDB314        | 586/546    | VD-325        |

**MATERIAL AVAILABILITY AND PART NO.**

| STD    | OPTIONS |   |     |     |
|--------|---------|---|-----|-----|
| FA     | HH      | R | MXS | GFA |
| FA67/2 | -       | - | -   | -   |

**Equivalents OE # - FA67/3**

43082 1116

**MATERIAL AVAILABILITY AND PART NO.**

| STD  | OPTIONS |        |       |     |     |
|------|---------|--------|-------|-----|-----|
| FA   | TT      | HH     | R     | MXS | GFA |
| FA67 | FA67TT  | FA67HH | FA67R | -   | -   |

**MATERIAL AVAILABILITY AND PART NO.**

| STD    | OPTIONS |   |     |     |
|--------|---------|---|-----|-----|
| FA     | HH      | R | MXS | GFA |
| FA67/3 | -       | - | -   | -   |

# FA68 67.8 x 40.7 x 9.5mm

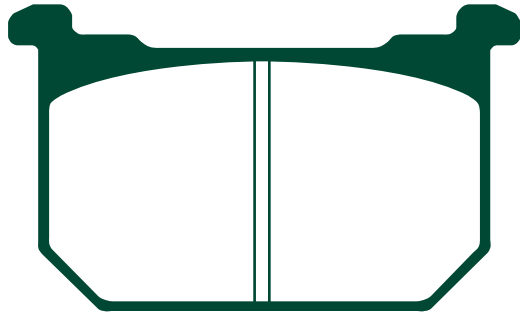

| MATERIAL AVAILABILITY AND PART NO. |         |   |     |     |
|------------------------------------|---------|---|-----|-----|
| STD                                | OPTIONS |   |     |     |
| FA                                 | HH      | R | MXS | GFA |
| FA68                               | FA68HH  | - | -   | -   |

### Competitor X Ref

| Dunlop    | Ferodo   | SBS     | Vesrah     |
|-----------|----------|---------|------------|
| DP308/309 | FDB298/R | 539/540 | VD-420/421 |

### KAWASAKI

|                            |       |     |
|----------------------------|-------|-----|
| Z 250 A3                   | 81    | F   |
| Z 400 J2/J3                | 81-83 | F   |
| Z 440 C2                   | 81    | F   |
| Z 440 D5/D6 (LTD)          | 83-84 | F   |
| Z 440 H1/H2                | 82-83 | F   |
| GPZ 550 H1/H2              | 82-83 | F&R |
| GPZ 550 D1                 | 82    | F&R |
| Z 550 A2/A3/C1/C2/LTD      | 81-84 | F   |
| Z 650 F2/F3/F4             | 80-83 | F   |
| Z 700 A1 'Ltd'             | 84    | F&R |
| Z 750 E1                   | 80    | F&R |
| Z 750 H1/H2/LTD            | 80-81 | F&R |
| Z 750 L1/L2/L3/L4          | 81-84 | F&R |
| Z 750 N1/N2 'Spectre'      | 82-83 | F&R |
| GT 750 P1-P9               | 82-96 | F&R |
| GPz 750 R1                 | 82    | F&R |
| Z 750 Y1 (LTD)             | 82    | F   |
| Z 1000 J1/J2/J3/K1/LTD/R2  | 81-83 | F&R |
| Z 1100 A1-A3               | 81-83 | F&R |
| GPz 1100 B1/B2             | 82-83 | F&R |
| Z 1100 D1/D2 'Spectre'     | 82-83 | F&R |
| Z 1100 R1 'Lawson Replica' | 84    | R   |

### Equivalents OE #

|            |            |            |
|------------|------------|------------|
| 43082 1007 | 43082 1021 | 43082 1025 |
| 43082 1008 | 43082 1022 | 43082 1026 |

# FA69 90 x 49 x 10mm

# FA69/2 90 x 49 x 9mm

# FA69/3 90 x 49 x 11.3mm

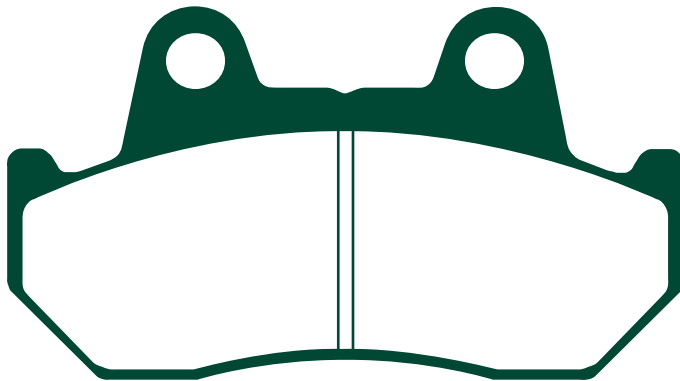

### Equivalents OE # - FA69

|                       |               |               |
|-----------------------|---------------|---------------|
| 06435 MT8 405         | 43105 MC7 014 | 45105 MF2 670 |
| 06455 MA3 405         | 43105 MJ6 004 | 45105 MJ1 672 |
| 451A0 MM9 670         | 43105 MJ6 007 | 45105 MK4 004 |
| 431A0 MC7 024         | 43105 MJ6 014 | 45105 MK6 671 |
| 431A0 MC7 305         | 45105 MA6 671 | 45105 MK7 671 |
| 451A0 MM9 670         | 45105 MB0 007 | 45105 MK7 672 |
| 43105 KE7 702         | 45105 MB0 008 | 45105 MM9 670 |
| 43105 MA3 004         | 45105 MB1 701 | 45105 MM9 781 |
| 43105 MA3 007         | 45105 MB1 702 |               |
| 43105 MC7 004 007/024 | 45105 MC4 004 |               |

### Equivalents OE # - FA69/2

|                       |               |                   |
|-----------------------|---------------|-------------------|
| 06455 443 405         | 43105 MJ6 724 | 45105 KN8 007     |
| 06455 KN8 405         | 45105 443 761 | 45105 006/016/026 |
| 431A0 MC7 024         | 45105 443 762 | 45105 KN8 712     |
| 45105 KL8 405         | 45105 KL8 004 | 45105 MC7 004     |
| 45105 KL8 405         | 45105 KL8 007 | 45105 MC7 007     |
| 43105 KN8 007         | 45105 KL8 014 | 45105 MC7 014     |
| 43105 MJ6 721/722/723 | 45105 KL8 712 | 45105 MC7 024     |

### Equivalents OE # - FA69/3

|                   |                   |               |
|-------------------|-------------------|---------------|
| 06435 MT8 405     | 43105 MB6 018/008 | 43105 MN5 008 |
| 06435 ML7 405     | 43105 MG9 007/017 | 43105 MT8 008 |
| 06435 ML7 415     | 43105 ML7 006     | 431A0 MN5 670 |
| 43105 MB4 007/017 | 43105 ML7 007     | 451A0 MM8 670 |
| 43105 MB4 008     | 43105 ML7 017     |               |
| 43105 MB4 305     | 43105 ML7 027     |               |

### Competitor X Ref

| Dunlop    | Ferodo   | SBS     | Vesrah     |
|-----------|----------|---------|------------|
| DP104/105 | FDB244/R | 542/572 | VD-123/132 |

### FA69 - HONDA

|                            |       |     |
|----------------------------|-------|-----|
| CB 125 TDC/TDE/TDJ         | 83-89 | F   |
| CBX 125 F                  | 84-   | F   |
| CBX 250 RSE                | 84    | F   |
| NS 400 RF/RG               | 85-87 | F&R |
| CMX 450 CH/CJ Rebel        | 87-88 | F   |
| CX 500 CC                  | 82    | F   |
| CX 500 EC                  | 82    | F&R |
| CX 500 TCC 'Turbo'         | 83    | F&R |
| FT 500 C                   | 82    | F&R |
| GL 500 DC                  | 82    | F   |
| VF 500 FE/F2E/FF/F2F       | 84-85 | F&R |
| XBR 500 F/G/H/SJ           | 85-89 | F   |
| XL 600 VH/VJ/VK "Transalp" | 87-90 | F   |
| CX 650 ED                  | 83    | R   |
| CB 750 FC/F2C/FD/F2D       | 83-84 | R   |
| CBX 750 FE                 | 84    | F   |
| VF 750 C Shadow            | 83    | F   |
| VF 750 S Sabre             | 82-83 | F   |
| VF 750 FD/FE               | 83-84 | F   |
| VF 750 SC                  | 82    | F   |
| XLV 750 R                  | 83-88 | R   |
| CB 900 FB/F2B              | 82-85 | R   |
| CB 900 FC/F2C/FD/F2D       | 84-85 | F&R |
| CBX 1000 B/C               | 81-82 | R   |
| VF 1000 FE/FF/FG/F2F/F2G   | 84-86 | F   |
| VF 1000 RE/RF/RG           | 84-86 | F   |
| CB 1100 RBII/RCII/RDII     | 80-83 | F&R |
| GL 1100 C/DC/AD 'Goldwing' | 82-83 | R   |

### FA69/2 - HONDA

|   |       |   |
|---|-------|---|
| CN 250 H/J/L/M/P/R/S/T/V/X SPAZIO/Helix | 87-98 | F |
| GB 250 E/H 'Clubman'                    | 84-87 | F |
| NS 250 FE (MC11)                        | 84    | F |
| NS 250 RE/RG (MC11)                     | 84-86 | F |
| CB 400 NC                               | 82    | F |
| CX 650 TD 'Turbo'                       | 83    | F |
| CX 650 ED                               | 83    | F |
| GL 650 D2-E                             | 84    | F |
| CB 750 FC/F2C/FD/F2D                    | 83-84 | F |
| CB 900 FB/F2B                           | 82-88 | F |
| CBX 1000 B/C                            | 81-82 | F |
| GL 1100 C/DC/1C Interstate 'Goldwing'   | 82    | F |
| GL 1100 AC Aspencade 'Goldwing'         | 82    | F |
| GL 1100 C/DC/AD                         | 82    | F |

### FA69/3 - HONDA

|                                 |       |     |
|---------------------------------|-------|-----|
| NS 250 FE (MC11)                | 84    | F   |
| NS 250 RE/RG (MC11)             | 84-86 | F   |
| NSR 250 RG (MC16)               | 86    | R   |
| CBR 400 RG/RHYA (NC23)          | 86-87 | R   |
| VFR 400 ZG/ZH/RG-YA (NC21)      | 85-87 | R   |
| CBR 500 FH/FJ/FK/FL             | 87-90 | R   |
| CBR 600 FH/FJ/FK/FL             | 87-90 | R   |
| CBR 750 FH Superaero            | 87    | R   |
| CBX 750 FE                      | 84    | R   |
| VF 750 FD/FE                    | 83-84 | R   |
| VF 750 CH                       | 87    | F   |
| VFR 750 FG/FH                   | 86-87 | R   |
| VF 1000 FE/FF/FG/F2F/F2G        | 84-86 | R   |
| CBR 1000 FH/FJ                  | 87-88 | R   |
| CB 1100 RB2/RC2/RD2             | 80-83 | R   |
| VT 1100 CH/CJ/CN/CP Shadow      | 87-93 | F   |
| GL 1200 DE/DF/DG/AE/AF/AG       | 84-86 | F&R |
| GL 1500 J/K/L/SEM/SEN/SEP/SER   |       |     |
| /SES/SEV/SEW/SEX/SEY "Goldwing" | 88-00 | R   |

### MATERIAL AVAILABILITY AND PART NO.

| STD  | OPTIONS |   |     |     |
|------|---------|---|-----|-----|
| FA   | HH      | R | MXS | GFA |
| FA69 | FA69HH  | - | -   | -   |

### MATERIAL AVAILABILITY AND PART NO.

| STD    | OPTIONS |   |     |     |
|--------|---------|---|-----|-----|
| FA     | HH      | R | MXS | GFA |
| FA69/2 | -       | - | -   | -   |

### MATERIAL AVAILABILITY AND PART NO.

| STD    | OPTIONS  |   |     |     |
|--------|----------|---|-----|-----|
| FA     | HH       | R | MXS | GFA |
| FA69/3 | FA69/3HH | - | -   | -   |

# FA70 66.5 x 59 x 10mm

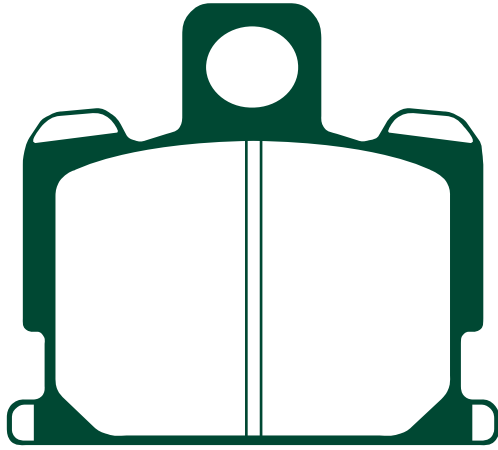

## YAMAHA

|                      |       |   |
|----------------------|-------|---|
| RD 50 MX/RD 50       | 81-87 | F |
| RD 80 (Air Cooled)   | 82    | F |
| RD 250               | 80-83 | F |
| RZ 250 (4L3)         |       | F |
| RD 350 LX            | 81-82 | F |
| XJ 550               | 81-84 | F |
| XJ 550 H/J/K Maxim   | 81-83 | F |
| XJ 550 RH/RJ/RK Seca | 81-83 | F |
| XJ 750               | 82-84 | F |
| XJ 750 RF/RJ/RK Seca | 81-83 | F |
| XS 1100 S            | 81    | F |

### Equivalents OE #

|              |              |
|--------------|--------------|
| 23W W0045 01 | 4W1 W0045 00 |
| 23W W0045 10 | 4W1 W0045 00 |
| 4L3 W0045 00 | 4W1 W0045 20 |
| 4L3 W0045 10 | 4W1 W0045 30 |

| MATERIAL AVAILABILITY AND PART NO. |         |   |     |     |
|------------------------------------|---------|---|-----|-----|
| STD                                | OPTIONS |   |     |     |
| FA                                 | HH      | R | MXS | GFA |
| FA70                               | -       | - | -   | -   |
| FA70S (Green)                      |         |   |     |     |

### Competitor X Ref

| Dunlop | Ferodo | SBS | Vesrah |
|--------|--------|-----|--------|
| DP402  | FDB277 | 547 | VD-228 |

# FA71 69.5 x 53.8 x 6.5mm



## HARLEY DAVIDSON

|   |            |   |
|---|------------|---|
| FX/FXE/FXEF/FXWG/FXS                                | Late 78-83 | F |
| XL/XLH/XLCH/XLS/XLX                                 | 79-83      | F |
| FXD, FXDL, FXDWG, FXR, FXRS, FXRT, FXRD, FXCR, FXDX | 82-83      | F |

### Equivalents OE #

|          |
|----------|
| 44032 77 |
| 44032 79 |

### Competitor X Ref

| Dunlop | Ferodo | SBS | Vesrah     |
|--------|--------|-----|------------|
| DP907  | FDB333 | 537 | VD-903/908 |

| MATERIAL AVAILABILITY AND PART NO. |         |   |     |     |
|------------------------------------|---------|---|-----|-----|
| STD                                | OPTIONS |   |     |     |
| FA                                 | HH      | R | MXS | GFA |
| FA71                               | -       | - | -   | -   |

# FA72 89 x 71.2 x 6.5mm



## HARLEY DAVIDSON

|                       |       |   |
|-----------------------|-------|---|
| XL/XLH/XLCH/XLS/XLX   | 79-81 | R |
| FLT/FLHT/FHTCI/FLHTWI | 80-83 | F |

### Equivalents OE #

|          |
|----------|
| 43395 80 |
|----------|

### Competitor X Ref

| Dunlop | Ferodo   | SBS | Vesrah |
|--------|----------|-----|--------|
| DP908  | FDB334/R | 543 | VD-909 |

| MATERIAL AVAILABILITY AND PART NO. |         |   |     |     |
|------------------------------------|---------|---|-----|-----|
| STD                                | OPTIONS |   |     |     |
| FA                                 | HH      | R | MXS | GFA |
| FA72                               | -       | - | -   | -   |

# FA73 A. 51.3 x 9.4mm B. 50 x 8mm

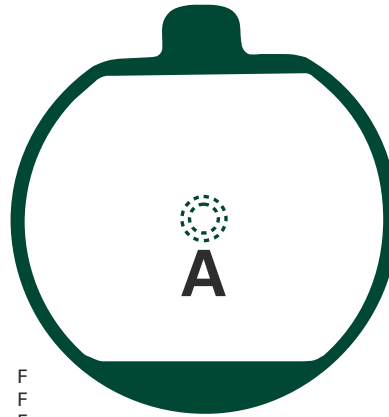
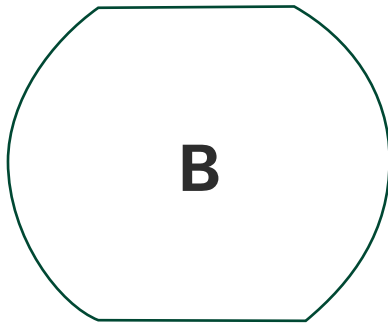

**Equivalents OE #**

|            |
|------------|
| 43082 1001 |
| 43082 1005 |

**KAWASAKI**

|                    |       |   |
|--------------------|-------|---|
| Z 250 A1/A2        | 78-80 | F |
| Z 400 J1           | 80    | F |
| Z 440 A2/C1        | 79-80 | F |
| Z 440 D4 (LTD)     | 82    | F |
| Z 500 B1/B2        | 79-80 | F |
| Z 550 A1           | 80    | F |
| Z 650 C3 (D2/D-SR) | 78-80 | F |
| Z 650 F1           | 79    | F |
| Z 650 D2/D3 (SR)   | 79-80 | F |
| Z 1000 A3/A4       | 79-80 | F |
| Z 1000 H1/H2       | 74-75 | F |
| Z 1000 D3 (ZIR)    | 79    | F |

**Competitor X Ref**

| Dunlop    | Ferodo | SBS | Vesrah     |
|-----------|--------|-----|------------|
| DP302/305 | FDB132 | 510 | VD-403/417 |

**MATERIAL AVAILABILITY AND PART NO.**

| STD  | OPTIONS |   |     |     |
|------|---------|---|-----|-----|
| FA   | HH      | R | MXS | GFA |
| FA73 | -       | - | -   | -   |

# FA74 38 x 51.5 x 7mm

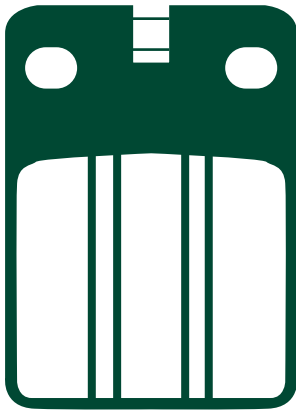

**LAVERDA**

|                              |       |     |
|------------------------------|-------|-----|
| LZ 125 Sport Grimeca caliper | 80-82 | F   |
| <b>MOTO MORINI</b>           |       |     |
| 125 KJ/T/KT Kanguro          | 84-   | F   |
| 350 Sport                    | 82-   | F&R |
| 350 Kanguro                  | 84-86 | F   |

**Equivalents OE #**

430963

**Competitor X Ref**

| Dunlop | Ferodo | SBS | Vesrah |
|--------|--------|-----|--------|
| N/A    | N/A    | N/A | N/A    |

**MATERIAL AVAILABILITY AND PART NO.**

| STD  | OPTIONS |   |     |     |
|------|---------|---|-----|-----|
| FA   | HH      | R | MXS | GFA |
| FA74 | -       | - | -   | -   |

# FA76 49 x 59 x 6mm

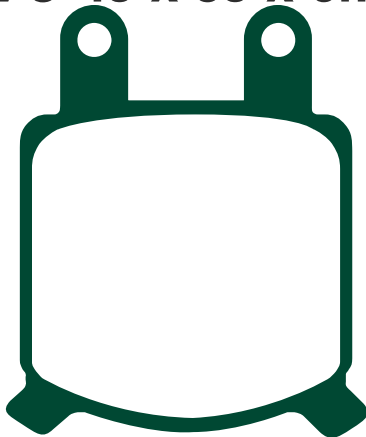

**ASPES**

|          |  |   |
|----------|--|---|
| 125 Duma |  | F |
|----------|--|---|

**JAYBRAKE**

2 Piston Caliper (Large)

**GARELLI**

|         |     |   |
|---------|-----|---|
| TSR 125 | -83 | F |
|---------|-----|---|

**GILERA**

|                  |  |   |
|------------------|--|---|
| 80 TG 1/2/3      |  | F |
| 125 GR 1         |  | F |
| 125 TG 1/2/3     |  | F |
| 200 T4/T4 C/T4 S |  | F |

**GMA**

2 Piston Caliper model B

**KREIDLER**

|             |  |   |
|-------------|--|---|
| Mustang 125 |  | F |
|-------------|--|---|

**LAVERDA**

|                       |     |   |
|-----------------------|-----|---|
| 125 (Grimeca Caliper) | 82- | F |
|-----------------------|-----|---|

**MOTO MORINI**

|                  |       |     |
|------------------|-------|-----|
| 125 Monocilindro | 79-   | F   |
| 250 All models   | 71-   | F   |
| 350 Sport        | -79   | F&R |
| 350 Sport        | 80-81 | F   |
| 350 FT/Turismo   | 80-   | F   |

**NVT**

|                 |  |   |
|-----------------|--|---|
| 125/175 Rambler |  | F |
|-----------------|--|---|

**MATERIAL AVAILABILITY AND PART NO.**

| STD  | OPTIONS |   |     |     |
|------|---------|---|-----|-----|
| FA   | HH      | R | MXS | GFA |
| FA76 | -       | - | -   | -   |

**Equivalents OE #**

310 292  
430 09 11

**Competitor X Ref**

| Dunlop | Ferodo | SBS | Vesrah |
|--------|--------|-----|--------|
| -      | FDB205 | 560 | VD-928 |

# FA77 60 x 58 x 9mm

## BENELLI

900 SE1 (6 cyl) 83 R

## BMW

R 65 07/88-08/89 F  
 R 80/R 80 RT 84-07/95 F  
 R 80 GS 87-95 F  
 R 80 PD/CH 90-95 F  
 R 850 GS 96 F  
 R 100 GS 86-94 F  
 R 100 PD 89-96 F

## LAVERDA

1000 RGS Corsa 84 F

## MOTO GUZZI

1000 Spada 78-94 R

### Equivalents OE #

|                 |                 |
|-----------------|-----------------|
| 34 11 1 354 720 | 34 11 2 310 601 |
| 34 11 2 331 177 | 18654660        |
| 34 11 2 314 545 |                 |

### Competitor X Ref

| Dunlop | Ferodo   | SBS | Vesrah |
|--------|----------|-----|--------|
| DP620  | FDB204/R | 554 | VD-933 |

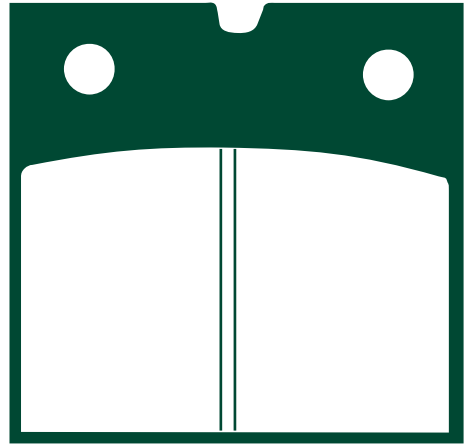

### MATERIAL AVAILABILITY AND PART NO.

| STD  | OPTIONS |   |     |     |
|------|---------|---|-----|-----|
| FA   | HH      | R | MXS | GFA |
| FA77 | -       | - | -   | -   |

# FA78 74.2 x 49 x 12mm



**NOW INCLUDES  
SHIMS x 2**

## HARLEY DAVIDSON

FX/FXE/FXEF/FXWG/FXS 84-86 R  
 FXWG/FXSB 83 R  
 XL/XLH/XLCH/XLS/XLX 82-Early 87 R  
 FXD, FXDL, FXDWG, FXR, FXRS, FXRT, FXRD, FXLR, FXDX 82-early 87 R  
 FXST, FXSTB, FXSTC, FXSTS, FLST, FLSTC, FLSTF, FLSTS, FLSTN 84-early 87 R

### Equivalents OE #

|           |
|-----------|
| 44209 82  |
| 44209 82A |

### Competitor X Ref

| Dunlop | Ferodo   | SBS | Vesrah |
|--------|----------|-----|--------|
| DP901  | FDB335/R | 549 | VD918  |

### MATERIAL AVAILABILITY AND PART NO.

| STD  | OPTIONS |   |     |     |
|------|---------|---|-----|-----|
| FA   | HH      | R | MXS | GFA |
| FA78 | -       | - | -   | -   |

# FA79 174 x 73.2 x 9.3mm

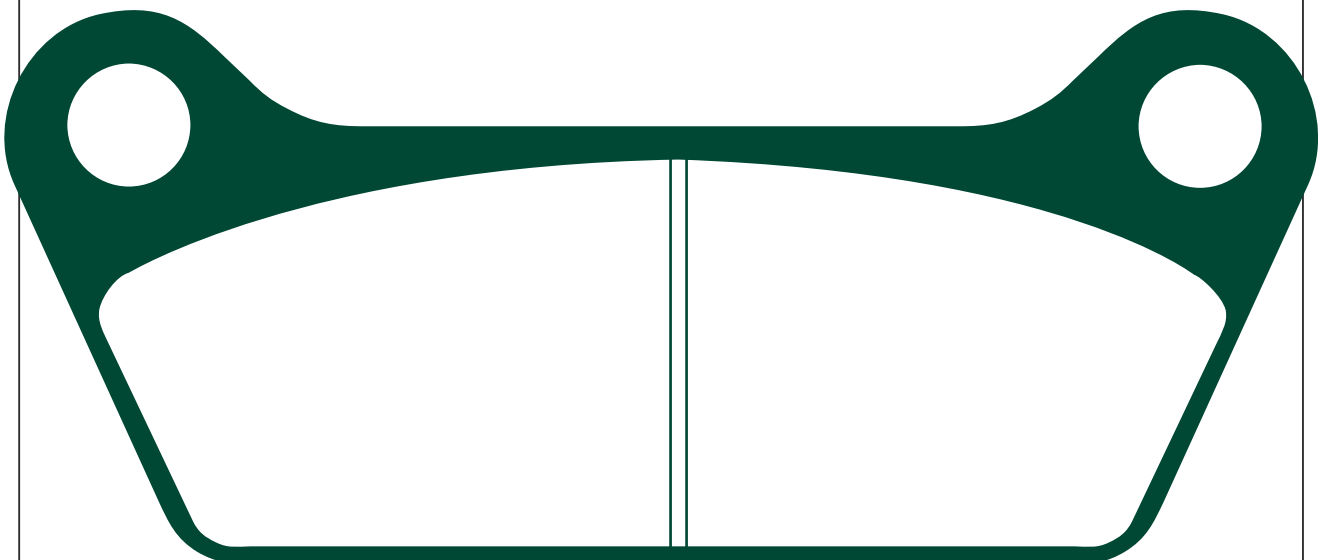

## HARLEY DAVIDSON

FL/FLH 81-84 R  
 FLT/FLHT/FLHTCI/FLHTCUI 80-85 R

### Equivalents OE #

|          |
|----------|
| 43957 80 |
|----------|

### Competitor X Ref

| Dunlop | Ferodo | SBS | Vesrah |
|--------|--------|-----|--------|
| -      | -      | 553 | VD-917 |

### MATERIAL AVAILABILITY AND PART NO.

| STD  | OPTIONS |   |     |     |
|------|---------|---|-----|-----|
| FA   | HH      | R | MXS | GFA |
| FA79 | -       | - | -   | -   |

# FA80 92 x 53 x 8mm

## FA80/2 92 x 53 x 9.5mm

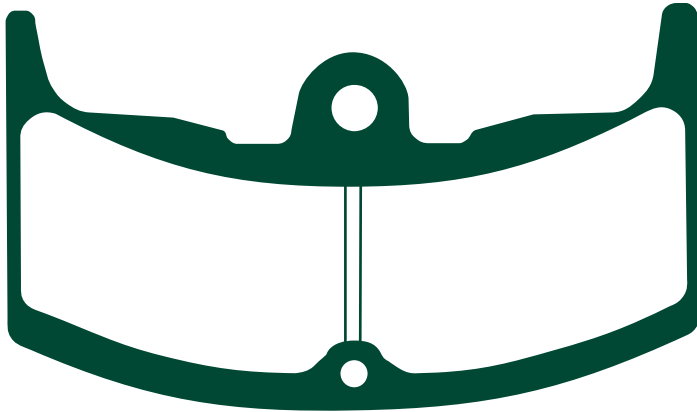

### FA80 - HONDA

CBX 550 FC/F2C/FD/F2D 82-84 F

### FA80/2 - HONDA

MXV 250 F (MC92) 83-88 F  
 VT 250 FD 83 F  
 VF 400 FD 83-85 F&R  
 VT 500 ED/EF 83-85 F  
 CBX 550 FC/F2C/F2D/FD 82-84 R

#### Equivalents OE # FA80

|               |               |
|---------------|---------------|
| 45105 MA7 007 | 45105 MA7 305 |
| 45105 MA7 004 |               |

#### Equivalents OE # FA80/2

|               |               |
|---------------|---------------|
| 45105 MA6 004 | 45105 MA6 305 |
| 45105 MA6 007 |               |

#### Competitor X Ref

| Dunlop | Ferodo   | SBS     | Vesrah       |
|--------|----------|---------|--------------|
| DP106  | FDB310/R | 552/571 | VD-129/129/2 |

| MATERIAL AVAILABILITY AND PART NO. |         |   |     |     |
|------------------------------------|---------|---|-----|-----|
| STD                                | OPTIONS |   |     |     |
| FA                                 | HH      | R | MXS | GFA |
| FA80                               | -       | - | -   | -   |

| MATERIAL AVAILABILITY AND PART NO. |         |   |     |     |
|------------------------------------|---------|---|-----|-----|
| STD                                | OPTIONS |   |     |     |
| FA                                 | HH      | R | MXS | GFA |
| FA80/2                             | -       | - | -   | -   |

# FA81 68 x 60 x 10.5mm

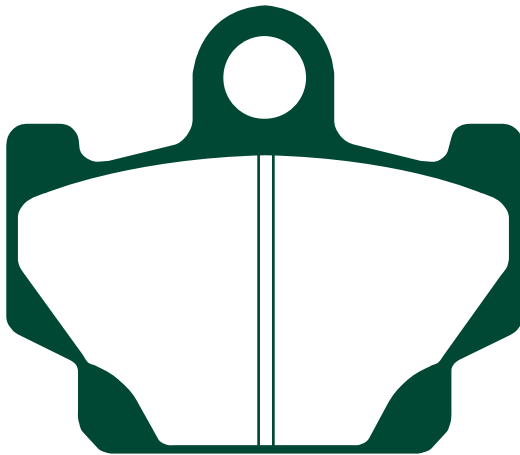

### YAMAHA

DT 80 LC (37A) 81-84 F  
 RD 80 LC 82 F  
 RX 115 (5FS3) 99 F  
 RD 125 LC 82-84 F  
 SR 125 SE 92-96 F  
 RX 135 (13X) 81 F  
 RZ 250 R (29L) F  
 XV 250 Virago 89-94 F  
 RD 350 YPVS 83-84 F  
 XS 400 82 F  
 XZ 550 82-84 F  
 XT 600 84-86 F  
 XT 600 (Z Tenere) 84 F  
 XJ 650 Turbo 82 F  
 XJ 650 LK 'Seca' 83 F

#### Competitor X Ref

| Dunlop | Ferodo | SBS | Vesrah |
|--------|--------|-----|--------|
| DP403  | FDB311 | 550 | VD-235 |

#### Equivalents OE #

|              |              |              |              |
|--------------|--------------|--------------|--------------|
| 11H W0045 00 | 11U W0045 10 | 2UJ W0045 00 | 4X8 W0045 00 |
| 11H W0045 01 | 22U W0045 10 | 2UJ W0045 01 | 52R W0045 00 |
| 11H W0045 11 | 29L W0045 00 | 34L W0045 10 | 5R2 W0045 00 |
| 11L W0045 00 | 29L W0045 10 | 43F W0045 00 | 3XL W0045 00 |
| 11U W0045 00 | 2KJ W0045 00 | 43F W0045 01 |              |

| MATERIAL AVAILABILITY AND PART NO. |         |       |     |     |
|------------------------------------|---------|-------|-----|-----|
| STD                                | OPTIONS |       |     |     |
| FA                                 | HH      | R     | MXS | GFA |
| FA81                               | -       | FA81R | -   | -   |

# FA83 A. 47.5 x 37 x 9mm B. 85 x 42.5 x 7mm

## FA83/2 A. 47.5 x 37 x 10mm B. 85 x 42.5 x 7.8mm

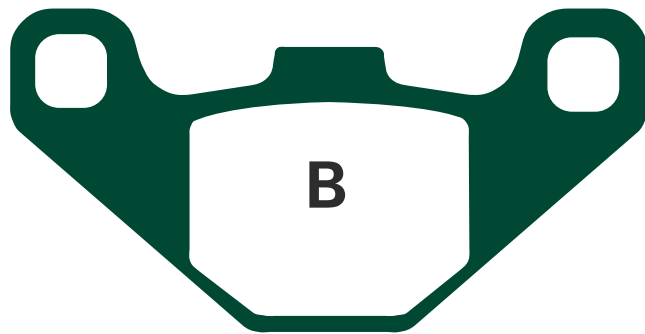

|   |       |     |  |  |  |
|---|-------|-----|--|--|--|
| <b>KAWASAKI</b>                                     |       |     |  |  |  |
| AR 50 A1/C2-C10                                     | 81-97 | F   |  |  |  |
| AH 80 Address                                       | 92-94 | F   |  |  |  |
| AR 80 A1/C1-C8                                      | 81-91 | F   |  |  |  |
| KX 80 E2/E3/G1/G2/J1/J2/L1-L3/N2/N3/<br>R1-R6/T1-T6 | 84-96 | F   |  |  |  |
| AH 100 Address                                      | 92-94 |     |  |  |  |
| KX 100 A1/A2/B1-B6                                  | 89-96 | F   |  |  |  |
| <b>KAWASAKI Contd.</b>                              |       |     |  |  |  |
| KMX 125 A1-A5/B1-B9                                 | 86-98 | F   |  |  |  |
| KX 125 B1   | 82    | F   |  |  |  |
| KDX 125 A1/A2/B1/B2                                 | 90-94 | F   |  |  |  |
| KMX 200 A2/A3                                       | 88-92 | F   |  |  |  |
| KX 250 B1   | 82    | F   |  |  |  |
| KXT 250 A1 Tecate                                   | 84    | R   |  |  |  |
| KXF 250 A1/A2 'Tecate 4'                            | 87-88 | R   |  |  |  |
| <b>ADLY</b>   |       |     |  |  |  |
| 50 RS Supersonic                                    | 06    | F&R |  |  |  |
| Silver Fox 50/100                                   | 06    | F   |  |  |  |
| Activator/Thunderbike 125                           |       | F&R |  |  |  |
| Jet 50/100  |       | F   |  |  |  |
| Predator 50/100                                     |       | F   |  |  |  |
| Panther 50/100                                      | 02-06 | F   |  |  |  |
| Cosy 50/80  | 02-06 | F   |  |  |  |
| RT 50/100   |       | F   |  |  |  |
| SS 50 1/11 Supersonic                               | 04-05 | F   |  |  |  |
| SS 100 1/11 Supersonic                              | 04-05 | F   |  |  |  |
| SS 125 B/D Supersonic                               | 04-05 | F&R |  |  |  |
| 150 Crusader Quad                                   | 06    | F&R |  |  |  |
| 150 Interceptor                                     | 06    | F&R |  |  |  |
| Interceptor 300                                     | 06    | R   |  |  |  |
| 300 Crusader Quad                                   | 06    | F&R |  |  |  |
| <b>AEON</b>   |       |     |  |  |  |
| Aero 50/100 (Scooter)                               | 06    | F   |  |  |  |
| Nox 50/100/125/150 Scooter                          | 06    | F   |  |  |  |
| Regal 50/90 (Scooter)                               | 06    | F   |  |  |  |
| Revo R50 Cobra 2 (AT34 Type) (Quad)                 | 04-06 | R   |  |  |  |
| Revo R100 Cobra 2 (AT34 Type) (Quad)                | 04-06 | R   |  |  |  |
| Pulsar 100/125/150 (Scooter)                        | 06    | F   |  |  |  |
| Sporty 125 (AT05 type) (Quad)                       | 01-05 | R   |  |  |  |
| Sporty 180 (AT05 type) (Quad)                       | 04-05 | R   |  |  |  |
| 200 Two Hundred Quad                                | 05    | F&R |  |  |  |
| Cobra 220 (Quad)                                    | 06-07 | F   |  |  |  |
| Overland 300 (Quad) (AT20)                          | 06-07 | F&R |  |  |  |
| <b>BLANEY (Quads)</b>                               |       |     |  |  |  |
| XC 125 Trojan                                       | 03-04 | R   |  |  |  |
| <b>BOMBARDIER</b>                                   |       |     |  |  |  |
| Rally 200   | 03-06 | F   |  |  |  |
| <b>BSM</b>  |       |     |  |  |  |
| TB 100  |       | F   |  |  |  |
| TB 125  |       | F&R |  |  |  |
| <b>CAN-AM</b>                                       |       |     |  |  |  |
| Rally 200 (4A7A/B/C/D/E/F)                          | 07    | F   |  |  |  |
| <b>COR QUADS</b>                                    |       |     |  |  |  |
| DN 50/50 E  | 05    | R   |  |  |  |
| DN 100/100 E  | 05    | R   |  |  |  |
| DN 150/150 E  | 05    | R   |  |  |  |
| DN 250  | 05    | R   |  |  |  |
| <b>CPI</b>  |       |     |  |  |  |
| 50 Hussar   | 01-03 | F   |  |  |  |
| 50 Mars   | 01    | F   |  |  |  |
| Baby J 50   | 02    | F   |  |  |  |
| Quad  | 03    | R   |  |  |  |
| Popcorn 50  | 02-03 | F   |  |  |  |
| ST 250 Sector Quad                                  | 05-06 | F   |  |  |  |
| XS 250 Power Quad                                   | 07    | F   |  |  |  |
| <b>COR</b>  |       |     |  |  |  |
| DN 250/Hammel                                       | 06    | F&R |  |  |  |
| DN 100  | 06    | R   |  |  |  |
| DN 250 Dolphin                                      | 06    | R   |  |  |  |
| RX 260  | 06    | F&R |  |  |  |
| Utility 250   | 06    | F&R |  |  |  |
| DN 150  |       | R   |  |  |  |
| DN 150 Extreme                                      |       | R   |  |  |  |
| <b>DAELIM</b>                                       |       |     |  |  |  |
| ET 250 Quad   | 06    | F   |  |  |  |
| <b>DERBI</b>  |       |     |  |  |  |
| DXR 200   | 04-07 | F   |  |  |  |
| DXR 250   | 04-07 | F   |  |  |  |
| <b>E-TON QUADS</b>                                  |       |     |  |  |  |
| BXL-50 Draco  | 05-06 | R   |  |  |  |
| EXL 50 Viper 50                                     | 07    | R   |  |  |  |
| Viper 50 Mini RXL 50 M                              | 03-07 | R   |  |  |  |
| Viper 50 RXL 50                                     | 03-06 | R   |  |  |  |
| Viper 70 RLX 70                                     | 05-07 | R   |  |  |  |
| BXL 100 Draco                                       | 05-06 | R   |  |  |  |
| RXL 90 Viper 90                                     | 03-07 | R   |  |  |  |
| RXL 90 R Viper 90 R Reverse                         | 03-07 | R   |  |  |  |
| Viper EXL 150 ST Quad                               | 05-07 | F   |  |  |  |
| EXL 150 Yukon ST                                    | 05-06 | F   |  |  |  |
| VXL 250 Vector                                      | 06    | F&R |  |  |  |
| Vector VXL 250 ST Quad                              | 06-07 | F&R |  |  |  |
| VXL 300 Vector                                      | 07    | F   |  |  |  |
| VXL 300 ST Vector ST                                | 07    | F   |  |  |  |
| VTX 300 Vortex                                      | 07    | F   |  |  |  |
| VTX 300 ST Vortex ST                                | 07    | F   |  |  |  |
| <b>GARELLI</b>                                      |       |     |  |  |  |
| Queenie   | 95-   | F   |  |  |  |
| Grinta  | 95-   | F   |  |  |  |
| <b>GILERA</b>                                       |       |     |  |  |  |
| Stalker 50  | 03-07 | F   |  |  |  |
| <b>GOES (Quads)</b>                                 |       |     |  |  |  |
| 220   | 06-07 | F&R |  |  |  |
| 320 Max   | 07    | F&R |  |  |  |
| <b>HYOSUNG</b>                                      |       |     |  |  |  |
| Super Cab/Cab Plus/Sense 50/Prima 50/Avanti         | 99-06 | F   |  |  |  |
| SF 50 R Rally Prima                                 | 00-06 | F   |  |  |  |
| SD 50   | 00-06 | F   |  |  |  |
| EZ 100  | 99-02 | F   |  |  |  |
| SF 100 R  | 05-06 | F   |  |  |  |
| FX 110 DLX Midas                                    | 99-04 | F   |  |  |  |
| Krillo Master                                       | 04    | F   |  |  |  |
| <b>KEEWAY</b>                                       |       |     |  |  |  |
| Focus 25/50   | 07    | F   |  |  |  |
| Matrix 25/50  | 06    | F   |  |  |  |
| Hurricane 50  | 07    | F   |  |  |  |
| Hurricane 50-Base                                   | 07    | F   |  |  |  |
| Focus 125   | 07    | F   |  |  |  |
| Matrix 125  | 06    | F   |  |  |  |
| Dragon 250 Quad                                     | 07    | F   |  |  |  |
| <b>MASAI</b>  |       |     |  |  |  |
| A 300 Quad  | 05-07 | F   |  |  |  |
| A 450 Quad  | 05-07 | F   |  |  |  |
| <b>MOTO-ROMA</b>                                    |       |     |  |  |  |
| Grand Prix 50/100                                   | 99-03 | F   |  |  |  |
| Grand Prix 125                                      | 02    | F&R |  |  |  |
| Geko 300 Quad                                       | 04-06 | F   |  |  |  |
| <b>MZ/MUZ</b>                                       |       |     |  |  |  |
| Moskito 50/50 SX                                    | 02    | F   |  |  |  |
| Moskito 125   | 02    | F   |  |  |  |
| VRS 150 Quad  | 05    | R   |  |  |  |
| <b>PEUGEOT (Heng Tong calipers)</b>                 |       |     |  |  |  |
| Various Scooter models (Check pad shape)            |       | F   |  |  |  |
| Trekker Off Road                                    | 98-01 | F   |  |  |  |
| Speed Fight   | 97-98 | F   |  |  |  |
| <b>PGO</b>  |       |     |  |  |  |
| Galaxy 25/50/90                                     | 94-   | F   |  |  |  |
| Mega 50   | 94-   | F   |  |  |  |
| Rider 150 50/90/110                                 | 04-05 | R   |  |  |  |
| <b>POLARIS</b>                                      |       |     |  |  |  |
| Phoenix 200   | 05    | R   |  |  |  |
| <b>QUADZILLA</b>                                    |       |     |  |  |  |
| X 50  | 06-07 | R   |  |  |  |
| Black Max M100 (SE)                                 | 06    | R   |  |  |  |
| R 100   | 06-07 | R   |  |  |  |
| Pro Shark   | 06    | R   |  |  |  |
| Pro Shark Type R                                    | 06    | R   |  |  |  |
| Pro Shark 100 R MX                                  | 07    | R   |  |  |  |
| Stinger R 250 E                                     | 06    | F   |  |  |  |
| 250 E   | 06    | F   |  |  |  |
| 300 E XLC   | 06-07 | F   |  |  |  |
| 300 SE 4 Valve                                      | 06-07 | F   |  |  |  |
| 4 Cross 200 E SUV                                   | 06-07 | F   |  |  |  |
| X 100 E (XLC)                                       | 06-07 | R   |  |  |  |
| Pro Shark-E   | 06    | R   |  |  |  |

# FA83 Contd. FA83/2 Contd.

## QUADZILLA Contd.

ST 200 E (5 Speed Manual)  
450 R

## ROXON

RX 150 (Quad)  
Sport Spirit NFS 150 (Quad)

## SUZUKI

AD 50 T/Tune/V-Tune  
AE 50 R  
AJ 50 ZZ/RS Sepia  
CP 50 C  
CR 50 DC  
RM 80 XL/XM/XN/XP/XR/XS  
RM 80 T/V/W/X/Y/K1  
RM 85 K2/LK2/K3/LK3/K4/LK4  
AH 100 P Address  
UE 125/150 CTK1

## TGB

Delivery 50 (From FE no 609100)  
Hornet 50/90 Quad  
Key West 50  
RS 50cc  
Sunset 50  
Trigger 50  
High Wheel 50  
F409 Cruise 50/125

06-07 F  
06-07 F  
04-06 R  
04-06 R  
88 F  
F  
92- F  
F  
F  
90-95 F&R  
96-01 R  
02-04 R  
95-96 F  
01-03 F  
06-07 F  
04-05 R  
06-07 F  
06-07 F  
07 F  
F  
F  
F  
05 F

## TGB Contd.

250 Blade/Congo ATV  
309 RS 50  
204 Classic  
R 50 X/507  
101 S  
Sunset 150

## TM

80/85 Minicross/Junior

## VIALLI

RX Sport 50

## FA83/2

### SUZUKI

RM 80 XG/XH/XJ/XK

### KAWASAKI

KSR1 (KMX50 B1/B2)  
KSR11 (KMX80 B1/B2)

### HONDA

MB 80 (MB8)

MCX 80

### PIAGGIO

NRG 50 DD  
NRG 50 Pure Jet  
NRG 50 Power DT  
Typhoon 50

06-07 R  
F  
F  
03-04 F  
06 R  
06 F  
07 F  
96-00 F  
06 F  
86-89 F  
90-91 F  
90-91 F  
80- F  
82- F  
06-07 F  
06-07 F  
05-06 F  
06-07 F

### Equivalents OE # - FA83/2

497417

### Equivalents OE # - FA83

|            |              |               |                 |
|------------|--------------|---------------|-----------------|
| 43050 1040 | 43082 1083   | 59300 03870   | 514069          |
| 43050 1043 | 43082 1115   | 59330 46F00   | 67131 5EE0 0000 |
| 43050 1044 | 43082 1164   | 59340 46F00   | GFS359902       |
| 43050 1048 | 45120 119 00 | 736502        | 59300 03860     |
| 43050 1051 | 69100 02821  | 752426        | 45110 B20T 000  |
| 43050 1126 | 59100 02820  | 752818        | 610143          |
| 43050 1169 | 59100 02821  | GF5359902     | 45110 JHFT 000  |
| 43082 1065 | 59100 02830  | 705 600 285   |                 |
| 43082 1079 | 59300 09810  | 45815RAM00/01 |                 |
| 43082 1081 | 59300 09811  | 610113 497417 |                 |

### Competitor X Ref

| Dunlop | Ferodo | SBS | Vesrah         |
|--------|--------|-----|----------------|
| DP312  | FDB313 | 544 | VD-339/342/442 |

### MATERIAL AVAILABILITY AND PART NO.

| STD    | OPTIONS |       |     |     |
|--------|---------|-------|-----|-----|
| FA     | HH      | R     | MXS | GFA |
| FA83TT | FA83HH  | FA83R | -   | -   |

### MATERIAL AVAILABILITY AND PART NO.

| STD      | OPTIONS |         |     |     |
|----------|---------|---------|-----|-----|
| FA       | HH      | R       | MXS | GFA |
| FA83/2TT | -       | FA83/2R | -   | -   |



# FA84 46 x 45 x 7.8mm

# FA84/2 46 x 45 x 6.5/7.8mm (1 piece each size per set)

# FA84/3 46 x 45 x 6.5mm

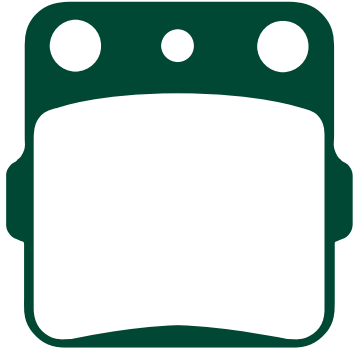

### FA84

#### ARCTIC CAT

DVX 400 04-07 F

#### HONDA

CR 80 RG/RH/RJ/RK/RL/RM/RN//RP/RR/RS/RT/RBT/RV

/RBV/RW/RBW/RX/RB/RBY/R1/RB1/RB2/R2

CR 85 R3/RB3/R4/RB4/R5/RB5/R6/RB6/R7/RS7

CRF 150 RB7/R7

ATC 250 RD 86-02 F

ATC 250 RC 03-07 F

TRX 250 EX1/2/3/4/5/6/7 07 F

TRX 300 EX P/R/S/T/V/W/X/Y/1/2/3/4/5/6/7 83-84 F&R

TRX 400 EXX/EXY/EX1/EX6 82 F

TRX 420 FE7/TE7/FM7/TM7 Fourtrax Rancher 01-07 F

#### HONDA HM (Italy)

CR 85 R/R2 03-07 F

CR 150 R/R2 07 F

#### HUSQVARNA

CR 125 92-94 R

WR 125 93-94 R

CR 250 92-94 R

WR 250 92-94 R

TE 350 92-94 R

CR 360 92-94 R

WR 360 92-94 R

TC 610 92-94 R

TE 610 92-94 R

### KAWASAKI

KX 80 L1-L3/N2/N3/R1-R7/T1-T6/W1/W2/W3 88-00 R

KX 85 A1-A5/A6F/A7F/B1-B5/B6F/B7F 01-07 R

KX 100 A1/A2/B1-B7/C1/C2/C3 89-00 R

KSF 250 A8-A18 94-04 R

KEF 300 B1/B2/B3 Lakota Sport 01-03 R

KVF 400 A1/A2/A3 (KFX 400) 03-05 F

KFX 450 R Quad 07 R

### SUZUKI

RM 100 K3 03 R

LT-Z 400 K3/K4/K5/K6/K7 03-07 F

LT-Z 250 F4/F5/F6/F7 QuadSport 04-07 F

### YAMAHA

YFS 200 R/S/T/V Blaster 03-06 R

YFZ 350 U/B/D/E/F/G/H/J/K/L/M/N/P/R/S/T/V Banshee 88-06 R

YFM 350 XD/XE/XF/XG/XH/XJ/XK/XL/XM/XN

/XP/XR/XS 92-04 R

YFM 350 FXG/FXH/FXJ/FXK/FXL/FXM

/FXN/FXP/FXR/FXS Wolverine 95-04 R

YFM 350 S/T/V/R-WV/RW Raptor 04-07 F&R

YFM 400 FWP Big Bear 4x4 02 F

YFZ 450 S/T 04-05 R

YFM 600 FWAK/FWAL/FWAM/FWAN 'Grizzly' 98-01 F

YFM 600 HM "Grizzly Hunting" 00 F

YFM 660 RN/RP/RR/RS Raptor 01-04 F&R

YFM 660 FWAP/FWAR/FWAS/FWAT/FWAV/FGW Grizzly 02-07 F

YFM 660 FR/FS/FT Grizzly 03-05 F

### FA84/2

#### HONDA

ATC 200 XD 83 F&R

### FA84/3

#### SUZUKI

RM 125 J 88 R

RM 250 H/J 87-88 R

#### TM

80/85 Minicross/Junior 96-00 R

### YAMAHA

YZ 80 E/F/LWF/LWG/G/LWH/H

/LWJ/J/LWK/K/L/LWL/LWM/M/LWN/N 93-01 R

YZ 85 P/LWP/R/LWR/S/LWS/T/LWT/V/LWW/W/LWW 02-07 R

YZ 125 W 89 R

YZ 250 W/WRW 89 R

### Equivalents OE # - FA84/2

|               |               |
|---------------|---------------|
| 431A0 965 000 | 45105 961 006 |
| 431A0 965 670 | 43120 965 000 |
| 43120 HC0 007 |               |

### Equivalents OE # - FA84/3

|              |              |
|--------------|--------------|
| 69140 26C00  | 3JD W0046 00 |
| 3JD W0046 01 | 4ES W0046 00 |
| 3JD W0046 10 | 5PA W0046 00 |

### Competitor X Ref - FA84

| Dunlop | Ferodo | SBS | Vesrah |
|--------|--------|-----|--------|
| DP811  | FDB381 | 592 | VD-128 |

### Competitor X Ref - FA84/2

| Dunlop | Ferodo | SBS | Vesrah   |
|--------|--------|-----|----------|
| -      | -      | 562 | VD-127/2 |

### Competitor X Ref - FA84/3

| Dunlop | Ferodo | SBS | Vesrah |
|--------|--------|-----|--------|
| DP816  | FDB661 | 584 | VD-127 |

### Equivalents OE # - FA84

|               |                   |               |
|---------------|-------------------|---------------|
| 06435 HA5 405 | 43120 HA5 305     | 06455 GBF J01 |
| 06435 HA5 670 | 43120 HA5 670     | 5LP W0046 00  |
| 1UY W0046 00  | 69140 19A00       | 5LP W0046 50  |
| 43082 5006    | 69140 19A01       | K4308 21205   |
| 43082 1205    | 69140 19A11       | 59300 42850   |
| 43106 961 006 | 69140 19A10       | 3406 031      |
| 45105 961 000 | 4WV W0045 00      | 3406 032      |
| 45110 HB7 007 | 45105 GC4 601     | 59300 42860   |
| 451A0 HB5 670 | 45105 GC4 602/603 | 59300 42870   |
| 43082 1066    | 45105 GBF 405     | 800070854     |
| 43082 1082    | 45112 GC4 601     | 800071451     |
| 431A0 HA5 670 | 45112 GC4 831     | 06435 HP5602  |

### MATERIAL AVAILABILITY AND PART NO.

| STD    | OPTIONS |       |       |     |
|--------|---------|-------|-------|-----|
| FA     | HH      | R     | MXS   | GFA |
| FA84TT | -       | FA84R | MXS84 | -   |

### MATERIAL AVAILABILITY AND PART NO.

| STD      | OPTIONS |         |     |     |
|----------|---------|---------|-----|-----|
| FA       | HH      | R       | MXS | GFA |
| FA84/2TT | -       | FA84/2R | -   | -   |

### MATERIAL AVAILABILITY AND PART NO.

| STD      | OPTIONS |         |         |     |
|----------|---------|---------|---------|-----|
| FA       | HH      | R       | MXS     | GFA |
| FA84/3TT | -       | FA84/3R | MXS84/3 | -   |

# FA85 A. 111 x 50 x 9.5mm B. 69x 43.5x 9.8mm

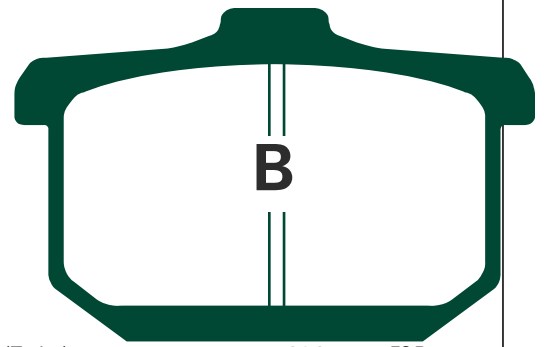
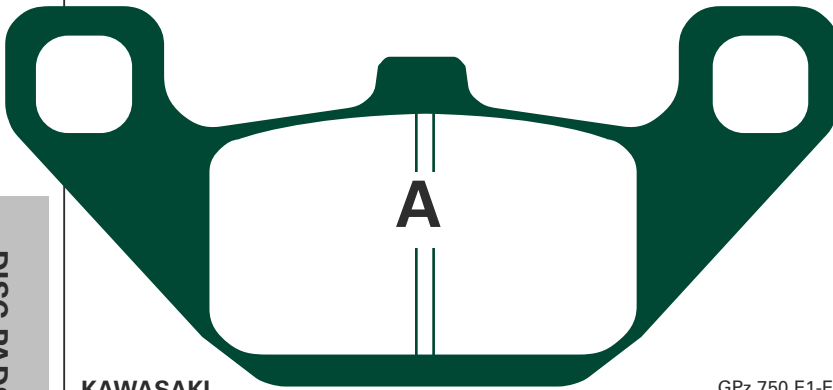

DISC PADS  
BUYERS GUIDE

## KAWASAKI

|                               |       |     |
|-------------------------------|-------|-----|
| EL 250 'Eliminator'           | 87-89 | F   |
| EL 250 D1-D5                  | 90-94 | F   |
| ER 250 B1-B3 (Z250T Scorpion) | 83-88 | F   |
| GPZ 250 R (EX 250 E)          | 86    | F&R |
| KR 250 A1/A2                  | 84-86 | R   |
| Z 400 C2/C3 (Z 400 F2)        | 85-87 | R   |
| ZL 400 A 'Eliminator'         | 86-87 | F   |
| FX 400 R (ZX400 E1-E3)        | 86-88 | R   |
| GPX 400 R (ZX 400 D1/D3/D3A)  | 85-87 | R   |
| LTD 450 (EN 450 A1-A5)        | 86-89 | F   |
| EN 500 A1-A3/B1-B2/C1-C9      | 90-04 | F   |
| GPz 550 A1-A4 (ZX 550 A1-A4)  | 84-87 | F&R |
| GPz 600 R A1-A5A              | 85-89 | F&R |
| VN 700 A1 'Vulcan'            | 85    | F   |
| ZN 700 A1/A2 'Ltd'            | 84-85 | F&R |
| GPz 750 A1-A5                 | 83-87 | F&R |

|                                |       |     |
|--------------------------------|-------|-----|
| GPz 750 E1-E2 (Turbo)          | 84-87 | F&R |
| GPz 750 R G2/G3                | 85-86 | F&R |
| VN 750 A2-A5/A10               | 86-94 | F   |
| VN 800 A1-A3                   | 95-99 | F   |
| GPz 900 R (A1-A6)              | 84-89 | F&R |
| ZL 900 A1/A2 'Eliminator'      | 85-86 | F&R |
| GPz 1000 RX (A1-A3)            | 86-88 | F&R |
| ZL 1000 A1                     | 87    | F&R |
| 1000 GTR (ZG 1000 A1-A7)       | 86-93 | F&R |
| 1000 GTR (ZR 1000 A9-A14)      | 94-99 | R   |
| GPz 1100 A1-A3                 | 83-85 | F&R |
| Z 1100 R1 'Lawson Replica'     | 84    | F   |
| VN 1500 B2-B6 (VN15SE)         | 88-92 | F&R |
| VN 1500 A6 (VN15)              | 92    | F&R |
| VN 1500 C1/C2 (VN15)           | 94-95 | F&R |
| VN 1500 D1/D2/E1/E2 "Classic"  | 96-99 | R   |
| VN 1500 G1/G2 'Classic Tourer' | 98-99 | R   |

## Equivalents OE #

|            |            |            |
|------------|------------|------------|
| 43082 1029 | 43082 1061 | 43082 1167 |
| 43082 1031 | 43082 1062 | 43082 1194 |
| 43082 1057 | 43082 1080 |            |

## Competitor X Ref

| Dunlop | Ferodo   | SBS | Vesrah         |
|--------|----------|-----|----------------|
| DP311  | FDB339/R | 557 | VD-424/<br>426 |

## MATERIAL AVAILABILITY AND PART NO.

| STD  | OPTIONS |   |     |     |
|------|---------|---|-----|-----|
| FA   | HH      | R | MXS | GFA |
| FA85 | FA85HH  | - | -   | -   |

# FA86 77.3 x 42.2 x 7.2mm

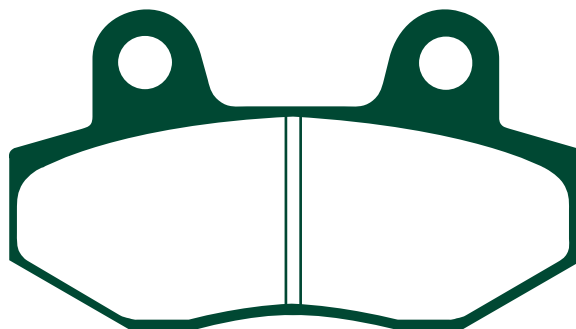

## CCM

|            |    |   |
|------------|----|---|
| C-XR 230 E | 07 | F |
| C-XR 230 S | 07 | F |

## DAELIM

|              |       |   |
|--------------|-------|---|
| Citi Ace 110 | 03-07 | F |
|--------------|-------|---|

## GARELLI

|              |    |   |
|--------------|----|---|
| Comfort 125  | 07 | F |
| Mosquito 150 | 07 | F |

## HERO

|               |    |   |
|---------------|----|---|
| Slickster 125 | 06 | F |
|---------------|----|---|

## HONDA

|                         |       |   |
|-------------------------|-------|---|
| MBX 50 SD/SF            | 83-85 | F |
| NSR 50 FP/FR/FS         | 93-95 | F |
| NSR 50 SK/SP/SR/SS      | 89-95 | F |
| NSR 80 J-2/K/L/N (HC06) | 88-92 | F |
| CBX 125 Custom          | 88-   | F |
| FS 125 Sonic            | 03-04 | F |
| LS 125 RY               | 00-   | F |
| MBX 125 FE              | 84-86 | F |
| CBX 250                 | 84-98 | F |

## HONGDOU

|                 |    |   |
|-----------------|----|---|
| CTM 125 Chituma | 04 | F |
|-----------------|----|---|

## HYOSUNG

|                         |       |     |
|-------------------------|-------|-----|
| RX 125                  | 01-02 | F   |
| RX 125 SM               | 06-07 | F&R |
| Comet 125               | 02    | F   |
| RT Karion 125           | 02-06 | F   |
| Exceed 125 (MS 125/150) | 02-04 | R   |
| GV 125                  | 04-07 | F   |
| GV 250                  | 01-07 | F   |
| XRX 125                 | 04-07 | F   |
| RX 400                  | 05    | F   |
| GV 650                  | 04-05 | F   |
| GV 1000                 | 04    | F   |
| Comet 650               | 04    | F&R |
| GT 250                  | 04-07 | F&R |
| GT 125                  | 04-07 | F&R |
| GT 125 R                | 06-07 | F   |
| Comet 125/250           | 04    | F&R |
| Comet 650               | 04    | F&R |
| GT 650 R                | 04-07 | F&R |
| GT 650 S                | 05-07 | F&R |
| GT 650                  | 06-07 | F&R |
| GT 650 X                | 07    | F&R |
| GV 650                  | 06-07 | F&R |
| GT 250 R                | 06-07 | F&R |

## ITALJET

|                     |    |     |
|---------------------|----|-----|
| Grifon # 59 (650cc) | 06 | F&R |
| Bazooka (650cc)     | 06 | F&R |

## JIALING

|                 |    |   |
|-----------------|----|---|
| JE 125 E Dragon | 98 | F |
|-----------------|----|---|

## KYMCO

|                          |       |   |
|--------------------------|-------|---|
| Pulsar 125 (Luxe)/CK 125 | 99-06 | F |
| Spike 100/125            | 00-06 | F |

## LIFAN

|          |  |   |
|----------|--|---|
| LF 100 A |  | F |
|----------|--|---|

## QUADZILLA

|                     |       |   |
|---------------------|-------|---|
| WK 110              | 05-06 | R |
| WK 125 (All models) | 06    | R |

## SACHS

|                      |       |     |
|----------------------|-------|-----|
| Madass 50 (4 stroke) | 04-05 | F   |
| Madass 50 (2 stroke) | 04-05 | F   |
| Mad Ass 50           | 06-07 | F   |
| Madass 125           | 05    | F&R |
| Mad Ass 125          | 06-07 | F   |

## SUPERBYKE

|                        |  |     |
|------------------------|--|-----|
| CQ 50 Road Classic     |  | R   |
| CU 125 Road Classic    |  | R   |
| M-Ped 125 Road Classic |  | F   |
| R-SR 250               |  | F&R |

## SYM

|             |       |   |
|-------------|-------|---|
| Wolf Legend | 04-05 | F |
|-------------|-------|---|

## VIALLI

|          |    |   |
|----------|----|---|
| Truro 50 | 06 | F |
|----------|----|---|

### Equivalents OE #

|               |               |                   |
|---------------|---------------|-------------------|
| 451A0 KR3 603 | 45105 KK4 014 | 45105 KR3 603     |
| 45105 GE2 004 | 45105 KR3 004 | 45105 KW7 405     |
| 45105 GE2 006 | 45105 KR3 007 | 45105 KBH E000 GM |
| 45105 GE2 305 | 45105 KR3 014 | P4064905001002640 |
| 45105 KK4 004 | 45105 KR3 601 |                   |
| 45105 KK4 007 | 45105 KR3 602 |                   |

### Competitor X Ref

|                        |                         |                   |                         |
|------------------------|-------------------------|-------------------|-------------------------|
| <b>Dunlop</b><br>DP111 | <b>Ferodo</b><br>FDB312 | <b>SBS</b><br>551 | <b>Vesrah</b><br>VD-131 |
|------------------------|-------------------------|-------------------|-------------------------|

### MATERIAL AVAILABILITY AND PART NO.

| STD  | OPTIONS |   |     |     |
|------|---------|---|-----|-----|
| FA   | HH      | R | MXS | GFA |
| FA86 | FA86HH  | - | -   | -   |

# FA88 64 x 55 x 9mm

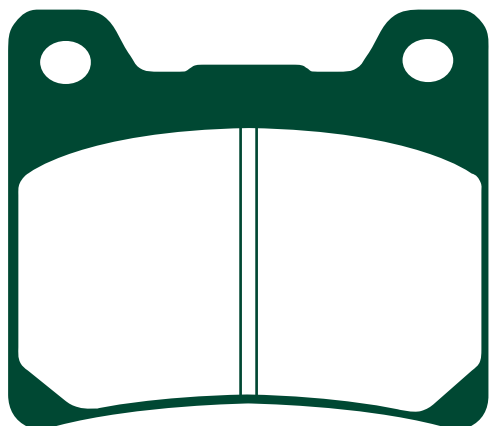

### Equivalents OE #

|              |              |              |
|--------------|--------------|--------------|
| 1FK W0045 00 | 26H W0045 10 | 38A W0045 01 |
| 1FK W0045 00 | 26H W0046 00 | 3HE W0045 00 |
| 1FK W0046 00 | 26H W0046 01 | 3HE W0045 11 |
| 1FK W0046 01 | 29L W0046 01 | 3XF W0045 00 |
| 1FX W0046 01 | 31A W0046 00 | 47X W0045 00 |
| 1KF W0045 00 | 31A W0046 10 | 47X W0045 01 |
| 1UF W0045 00 | 33M W0045 01 | 4FM W0046 00 |
| 1UF W0045 01 | 33M W0045 10 | 4SV W0045 50 |
| 26H W0045 00 | 36H W0046 01 |              |
| 26H W0045 01 | 37A W0045 00 |              |

### Competitor X Ref

| Dunlop | Ferodo   | SBS | Vesrah |
|--------|----------|-----|--------|
| DP404  | FDB337/R | 555 | VD-236 |

| MATERIAL AVAILABILITY AND PART NO. |         |   |     |     |
|------------------------------------|---------|---|-----|-----|
| STD                                | OPTIONS |   |     |     |
| FA                                 | HH      | R | MXS | GFA |
| FA88                               | FA88HH  | - | -   | -   |

## NORTON

|                                      |       |     |
|--------------------------------------|-------|-----|
| Commander                            | 90    | F&R |
| <b>YAMAHA</b>                        |       |     |
| TZR 125                              | 90-92 | F   |
| RD 350 YPVS                          | 83-84 | R   |
| FZ 400                               | 96    | R   |
| FZ 400 N (IFK/46X/33M)               | 85    | F   |
| FZR 400 Genesis (1WG)                | 86    | F   |
| SRX 400 (1JL)                        | 85    | F   |
| XJR 400                              | 95-   | R   |
| RD 500 LC                            | 84-86 | F   |
| FZ 600                               | 87-88 | F   |
| FZR 600                              | 89    | F&R |
| FZR 600                              | 90-93 | R   |
| FZR 600 R                            | 94-95 | R   |
| YZF 600 R "Thundercat"               | 96-03 | R   |
| XJ 600                               | 84-91 | F&R |
| YX 600 S/SC/T/TC/UC/U/W/WC           |       |     |
| /A/AC 'Radian'                       | 86-90 | F   |
| FZX 700 S/SC/T/TC Fazer              | 86-87 | F&R |
| FZ 750                               | 85-88 | F&R |
| FZ 750                               | 89-91 | R   |
| FZX 750                              | 87    | F&R |
| FZR 750 'Genesis'                    | 87    | R   |
| FZR 750 R "OWOI"                     | 89-90 | R   |
| XV 750 Virago                        | 92-93 | F   |
| YZF 750 R/SP                         | 93-97 | R   |
| TDM 850                              | 91-01 | R   |
| TRX 850                              | 96-99 | R   |
| XJ 900/900 F                         | 83-92 | F&R |
| XJ 900 S "Diversion"                 | 95-03 | R   |
| GTS 1000                             | 93-99 | R   |
| FZR 1000 Genesis                     | 87-88 | R   |
| FZR 1000 'EX UP'                     | 89-95 | R   |
| YZF 1000 R "Thunderace"              | 96-02 | R   |
| XV 1000/1000 SE "Virago"             | 86-88 | F   |
| BT 1100 P/R/S/T/V Bulldog            | 02-06 | R   |
| FJ 1100                              | 84-85 | F&R |
| XV 1100 Virago                       | 89-93 | F   |
| XV 1100 Virago                       | 99    | R   |
| XVS 1100 Dragstar                    | 99-04 | R   |
| XVS 1100 A "Dragstar Classic"        | 00-07 | R   |
| FJ 1200 (ITX Type)                   | 86-87 | F&R |
| FJ1200 (3CV/3XW Type)                | 88-95 | R   |
| FJ 1200 A (ABS model)                | 91-95 | R   |
| XVZ 12 TD                            | 85    | F&R |
| V-MAX 12                             | 91-92 | F&R |
| V-MAX 12                             | 93-03 | R   |
| XJR 1200                             | 95-98 | R   |
| XJR 1300 (5EA1/5EA7) Brembo calipers |       |     |
| (320mm front discs)                  | 98-99 | R   |
| XJR 1300 L 5EA2/5EA3/5EA4            | 99    | R   |
| XJR 1300 M 5EAA/5EAB/5EAC            | 00    | R   |
| XJR 1300/1300 SP                     | 99-01 | R   |
| XJR 1300 SP (L) 5EA5/5EA6/5EA8       | 99    | R   |
| XJR 1300 SP (M) 5EAD/5EAE/5EAF       | 00    | R   |
| XJR 1300 SP (N) 5EAL/5EAM/5EAN       | 01    | R   |

# FA90 91 x 51 x 10mm

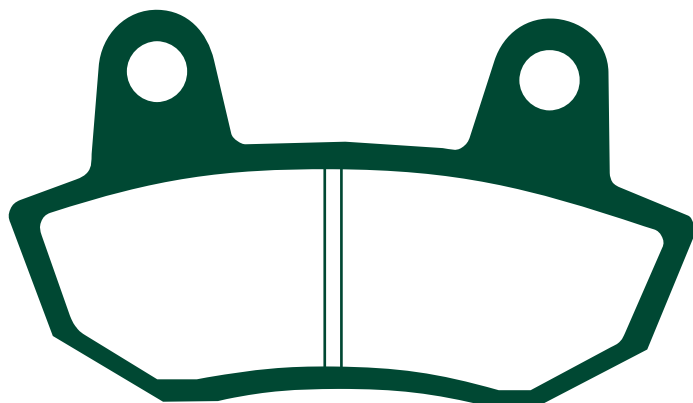

### Equivalents OE #

|               |
|---------------|
| 45105 MA5 771 |
| 45105 MA5 772 |
| 45105 MC9 305 |

### Competitor X Ref

| Dunlop | Ferodo  | SBS | Vesrah |
|--------|---------|-----|--------|
| -      | FDB2020 | 561 | VD-130 |

| MATERIAL AVAILABILITY AND PART NO. |         |   |     |     |
|------------------------------------|---------|---|-----|-----|
| STD                                | OPTIONS |   |     |     |
| FA                                 | HH      | R | MXS | GFA |
| FA90                               | -       | - | -   | -   |

## HONDA

|                        |    |   |
|------------------------|----|---|
| CB 650 SCC "Nighthawk" | 82 | F |
|------------------------|----|---|

# FA92 81 x 42 x 7.5mm

## FA92/2 Use FA323/2

## FA92/3 Use FA323/3

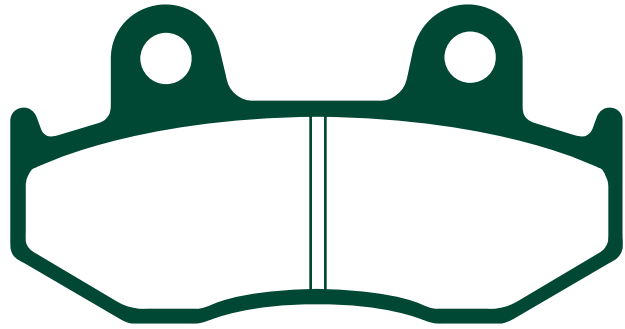

### HONDA

|                             |       |     |
|-----------------------------|-------|-----|
| CR 125 RE/RF/RG             | 84-86 | F   |
| MTX 125 RWE/RWF/RWH/RWL     | 85-95 | F   |
| XL 125 RF/RH                | 85-86 | F   |
| XL 200 R                    | 85    | F   |
| MTX 200 RWF                 | 85    | F   |
| FTR 223 (MC34) Y/2/A2       | 00-02 | F   |
| ATC 250 RF/RG               | 85-86 | F&R |
| CR 250 RE/RF/RG             | 84-86 | F   |
| XR 250 RE/RF/RG/RH          | 84-87 | F   |
| XLR 250 R (MD22)            | 88-90 | F   |
| TRX 250 RG/RH/RJ/RK         | 86-89 | R   |
| XR 350 RE                   | 84    | F   |
| CR 500 RE/RF/RG             | 84-86 | F   |
| XR 500 RD/RE                | 84-85 | F   |
| XL 600 RD/LD/RE/LE/RF/RG/RH | 83-87 | F   |
| XL 600 LMF                  | 85    | F   |
| XR 600 RF-RH                | 85-87 | F   |

### Equivalents OE # - FA92

|               |               |               |
|---------------|---------------|---------------|
| 43105 HB9 008 | 45105 HA2 671 | 45105 KE1 744 |
| 431A0 HB9 008 | 45105 HB9 008 | 45105 KS5 004 |
| 451A0 MG3 670 | 45105 KA3 731 | 45105 KS5 006 |
| 451A0 KA3 731 | 45105 KE1 742 | 45105 MG3 006 |
| 45105 G04 601 | 45105 KE1 743 | 06455 KPM 006 |

### Competitor X Ref

| Dunlop    | Ferodo | SBS | Vesrah         |
|-----------|--------|-----|----------------|
| DP812/114 | FDB382 | 558 | VD-134/<br>136 |

### MATERIAL AVAILABILITY AND PART NO.

| STD    | OPTIONS |       |     |     |
|--------|---------|-------|-----|-----|
| FA     | HH      | R     | MXS | GFA |
| FA92TT | -       | FA92R | -   | -   |

# FA93 A. 88 x 48 x 7.8mm B. 56 x 36.6 x 10.2mm

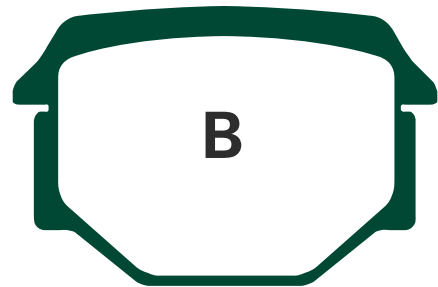
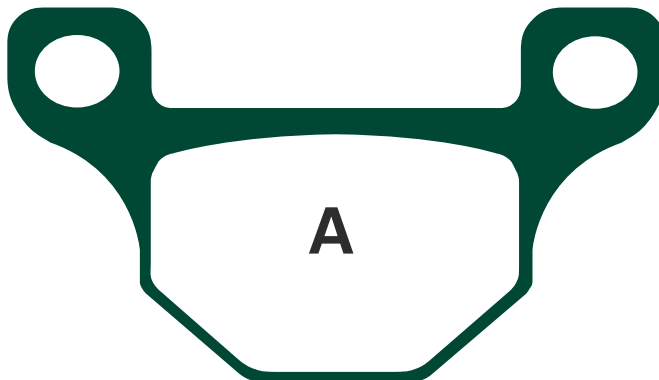

### DERBI

|           |    |   |
|-----------|----|---|
| GPI 250 i | 07 | R |
|-----------|----|---|

### SUZUKI

|                        |       |   |
|------------------------|-------|---|
| GS 125 ESD/ESF/ESK/ESM | 83-94 | F |
| GX 125 (SJ 125)        | 03    | F |

### EASY RIDER

|                 |    |   |
|-----------------|----|---|
| JC 125/8 Dragon | 98 | F |
|-----------------|----|---|

### HARTFORD

|                |       |   |
|----------------|-------|---|
| HD 125 L/150 L | 00-04 | F |
|----------------|-------|---|

### KEEWAY

|           |    |   |
|-----------|----|---|
| Speed 125 | 07 | F |
|-----------|----|---|

### MOTO-ROMA

|            |    |   |
|------------|----|---|
| Virage 125 | 01 | F |
|------------|----|---|

### SUPERBYKE

|                    |  |   |
|--------------------|--|---|
| RFX 50 Road Trail  |  | F |
| RFX 125 Road Trail |  | F |

### TGB

|                         |       |   |
|-------------------------|-------|---|
| R9 125cc                | 06-07 | F |
| Delivery 151cc          | 04-07 | F |
| 302 Sport               | 03-04 | F |
| 303R Hawk/Laser 125/150 | 04-07 | F |
| 304 Sport               | 03-04 | F |
| 404 Executive           | 03-04 | F |
| F409 (50/125/150)       | 06    | F |
| R 50 X/507              | 06-07 | F |

### WUYANG

|            |       |   |
|------------|-------|---|
| WY 125-12  | 06-07 | F |
| WY 125 16C | 06-07 | F |

### Competitor X Ref

| Dunlop | Ferodo | SBS | Vesrah |
|--------|--------|-----|--------|
| -      | FDB384 | 585 | VD-346 |

### Equivalents OE #

|             |               |
|-------------|---------------|
| 59301 39841 | 45120 128 000 |
| 59300 29820 |               |

### MATERIAL AVAILABILITY AND PART NO.

| STD  | OPTIONS |   |     |     |
|------|---------|---|-----|-----|
| FA   | HH      | R | MXS | GFA |
| FA93 | -       | - | -   | -   |

# FA94 60 x 63 x 13mm



## HARLEY DAVIDSON

|   |          |   |
|---|----------|---|
| FXD/FXD/L/FXDWG/FXR/FXRS/FXRT/FXRD/FXLR             | 91-99    | F |
| FXST/FXSTB/FXSTC/FXSTS/FLST/FLSTC/FLSTF/FLSTS/FLSTN | 84-99    | F |
| FLSTSC/FLSTSCI                                      | 05       | F |
| FX/FXE/FXEF/FXWG/FXS                                | 84-86    | F |
| XL/XLH/XLCH/XLS/XLXH                                | 84-99    | F |
| FXR/FXRS/FXRT/FXRD/FXLR                             | 94-97    | F |
| FLT/FLHT/FLHTCI/FLHTCUI                             | 84-99    | F |
| FLHR/FLHRC/FLTRI                                    | 94-99    | F |
| FXSTS/FXSTSi  | 00-04/06 | F |
| FLSTS Heritage Springer                             | 00-03    | F |
| FLSTSC/FLSTSCI Springer Softail                     | 06-07    | F |

### Competitor X Ref

| Dunlop | Ferodo   | SBS | Vesrah |
|--------|----------|-----|--------|
| DP900  | FDB352/R | 579 | VD-919 |

### Equivalents OE #

|          |           |           |           |
|----------|-----------|-----------|-----------|
| 43063 83 | 44063 83A | 44063 839 | 44063 83C |
|----------|-----------|-----------|-----------|

### MATERIAL AVAILABILITY AND PART NO.

| STD  | OPTIONS |   |     |     |
|------|---------|---|-----|-----|
| FA   | HH      | R | MXS | GFA |
| FA94 | FA94HH  | - | -   | -   |

# FA95 69.2 x 51 x 8.2mm

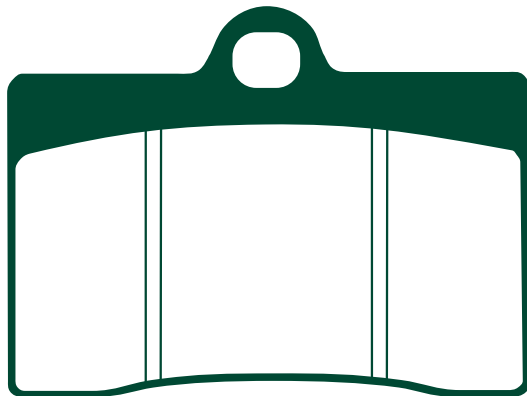

|  |       |     |
|--|-------|-----|
| <b>HONDA</b><br>CBR 900 'Evolution Blade'                  | 99    | F   |
| <b>HUSQVARNA</b><br>SM 400 R                               | 02    | F   |
| SM 450 R   | 03-06 | F   |
| SM 510 R   | 06-   | F   |
| SM 570 R   | 01-04 | F   |
| SMR 630  | 06    | F   |
| <b>KTM</b><br>Sting 125                                    | 97-99 | F   |
| Duke 400 LC4   | 94-98 | F   |
| Duke 620 LC4   | 94-98 | F   |
| SMC 660 Supermoto  | 03-04 | F   |
| <b>LAVERDA</b><br>650 All models                           | 94-95 | F   |
| 668 All models   | 96-98 | F   |
| 750 All models   | 98-01 | F   |
| <b>MONDIAL</b><br>Piega 1000                               | 02    | F   |
| <b>MOTO GUZZI</b><br>Daytona 1000 (RS)                     | 93-97 | F   |
| V10 Centauro/GT  | 98-00 | F   |
| California EV 1100   | 98    | F   |
| Sport V11  | 98-99 | F   |
| California/EV/Special                                      | 99-00 | F   |
| <b>MZ/MUZ</b><br>Skorpion/Tour/Sport/Traveller/Cup         | 95-02 | F   |
| <b>NORTON</b><br>Formula One                               | 90    | F   |
| F1 (Rotary) P55 Model                                      | 90-91 | F   |
| <b>PGO</b><br>G Max 125                                    | 06-07 | F   |
| G Max 250  | 06    | F   |
| <b>REVTECH/WILWOOD</b><br>CCI Polished Caliper (CC159-110) |       | F&R |
| <b>TM</b><br>SMR 125                                       | 05    | F   |
| SM 250   | 02    | F   |
| SME 250 (4T)   | 04-   | F   |
| SME 400 (4T)   | 04    | F   |
| SM 400   | 02-03 | F   |
| SMR 450/530 FAE  | 05    | F   |
| SMR 450 FES  | 05-07 | F   |
| EN 530 F-ES  | 03-04 | F   |
| SM 530   | 02-03 | F   |
| SME 530 (4T)   | 04-   | F   |
| SMR 530 FES  | 05-07 | F   |
| 530 (4T) Cross   | 02-03 | F   |
| SMR 125/250/250 (4T)/300                                   | 06    | R   |
| SMX 660 F  | 04-   | F   |
| <b>YAMAHA</b><br>TZR 125 RR                                | 96-   | F   |
| SZR 660  | 96-97 | F   |
| <b>SACHS</b><br>XTC 125 Supersport                         | 00-07 | F   |
| X Road 125   | 06-07 | F   |
| Roadster 650   | 05    | F   |
| Roadster 800   | 01-05 | F   |
| B-805  | 03-04 | F   |
| <b>VOR</b><br>SM-E 450/530                                 | 03-04 | F   |
| <b>VOXAN</b><br>Cyclope 1000                               | 02    | F   |
| Cafe Racer 1000  | 02-05 | F   |
| Roadster 1000  | 02-05 | F   |
| Street Scrambler   | 03-05 | F   |

### Equivalents OE #

|              |                |           |
|--------------|----------------|-----------|
| 4SU F5811 00 | 8000 78331     | 800094411 |
| 613 4 004 24 | 047 00 2000036 | 211041010 |
| 613 4 009 1A | 573 V3 030 000 | 27 69173  |
| 613 4 0041 A | 90210 55000    |           |
| 8113585      | BE250122065SM  |           |

### Competitor X Ref

| Dunlop | Ferodo | SBS | Vesrah |
|--------|--------|-----|--------|
| DP614  | FR 408 | 566 | VD-945 |

### MATERIAL AVAILABILITY AND PART NO.

| STD  | OPTIONS |   |     |         |
|------|---------|---|-----|---------|
| FA   | HH      | R | MXS | GFA     |
| FA95 | FA95HH  | - | -   | GFA95HH |

|  |       |   |
|--|-------|---|
| <b>APRILIA</b><br>RS 250 All models                                      | 95-97 | F |
| B 500 CR   | 02    | F |
| B 500 MT   | 02    | F |
| <b>BENELLI</b><br>666 Scooter "Born in Hell"                             | 98-99 | F |
| <b>BETA</b><br>Euro/Jonathan 350   | 03-06 | F |
| Jonathan 125   | 00-05 | F |
| <b>BIMOTA</b><br>Various models  | 89-03 | F |
| Tesi 2D  | 05-06 | F |
| <b>BREMBO</b><br>20 5165 55/65 Goldline 4 piston (single pin pad fixing) |       |   |
| 20 4756 05/06 Billet 4 piston (single pin pad fixing)                    |       |   |
| <b>BORILE</b><br>B 500 CR  | 02-04 | F |
| B 500 MT   | 02    | F |
| <b>CAGIVA</b><br>Mito 125  | 93-07 | F |
| N1 125   | 97    | F |
| Planet 125   | 99-03 | F |
| Raptor 125   | 03-07 | F |
| Mito 500   | 07    | F |
| River 600  | 95-99 | F |
| <b>CCM</b><br>CR 40 S Cafe Racer   | 07    | F |
| CR 40 Street   | 07    | F |
| <b>DUCATI</b><br>Supersport 400  | 93-97 | F |
| 400 Monster  | 95-97 | F |
| 600 Monster  | 93-99 | F |
| 600 Monster Dark   | 98-99 | F |
| 600 Monster City/City Dark   | 99    | F |
| 600 Supersport   | 91-97 | F |
| 748 SP/Biposto   | 95-98 | F |
| 750 Supersport   | 91-98 | F |
| 750 Monster  | 96-98 | F |
| 750 Monster City/City Dark   | 99    | F |
| 750 Monster/Monster Dark   | 99    | F |
| 851 Superbike Biposto  | 89-92 | F |
| 884 SP4/SP5  | 92-93 | F |
| 888 Superbike Strada   | 94-95 | F |
| 900 Supersport   | 89-90 | F |
| 900 Supersport/Superlight  | 91-97 | F |
| 900 Supersport CR USA  | 98    | F |
| 900 Supersport FE  | 98    | F |
| 900 Monster  | 93-99 | F |
| 900 Monster Cromo/Special  | 98    | F |
| 900 Monster City/City Dark   | 99    | F |
| 907 IE   | 90-93 | F |
| 916 SP   | 94-96 | F |
| 916 Biposto-Senna  | 94-98 | F |
| 916 Racing (996cc)   | 98    | F |
| 996 Racing   | 99    | F |
| <b>GAS GAS</b><br>SM 125/250/400 FSE                                     | 02    | F |
| SM 125/250 (2T)  | 01-06 | F |
| SM 400 FSE (2T)  | 01-04 | F |
| FSR 450 (4T)   | 07    | F |
| SM 450   | 03-04 | F |
| <b>GILERA</b><br>Saturno 350 Bialbero                                    | 90-   | F |
| Saturno 500 S/Bialbero/Piuma   | 90-   | F |

# FA98 43.5 x 64.5 x 6.5mm

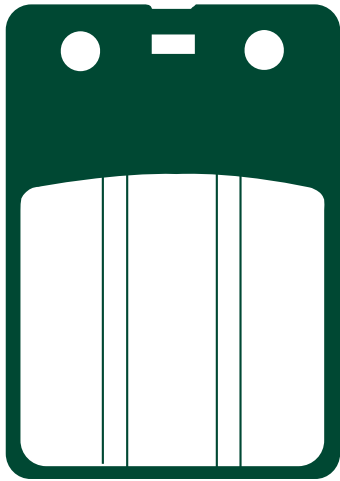

## GARELLI

Strada/Sport 125 F  
TSR 125 83- F

## GILERA

RV 125 88 F  
RV 200 85-86 F

### Competitor X Ref

| Dunlop | Ferodo | SBS | Vesrah |
|--------|--------|-----|--------|
| -      | FDB696 | 606 | VD930  |

### Equivalents OE #

|             |
|-------------|
| 323 628     |
| 400 07 6340 |

### MATERIAL AVAILABILITY AND PART NO.

| STD  | OPTIONS |   |     |     |
|------|---------|---|-----|-----|
| FA   | HH      | R | MXS | GFA |
| FA98 | -       | - | -   | -   |

# FA99 31.5 x 52 x 5.5mm



### Equivalents OE #

|               |
|---------------|
| 266 07 6340   |
| 510 362 4 282 |
| 464143        |
| 11933400      |

### Competitor X Ref

| Dunlop | Ferodo | SBS | Vesrah |
|--------|--------|-----|--------|
| DP602  | FDB436 | 595 | VD-932 |

### MATERIAL AVAILABILITY AND PART NO.

| STD  | OPTIONS |       |     |     |
|------|---------|-------|-----|-----|
| FA   | HH      | R     | MXS | GFA |
| FA99 | -       | FA99R | -   | -   |

## APRILIA

TRX 240 M 89 F&R

## BENELLI

Devil 50 92- R  
Spring 50 93- R  
Devil 80 92- R

## BETA

TR 32/33 125 86-87 F  
TR 33 240 86 F  
TR 34 260 89-91 F  
TR 34 86-88 F

## CIMATTI

Gringo 85- F

## FANTIC

50.1 Oasis Kick 87- F  
50.1 Trial 86- F  
50.1 Trial H 20 87- F  
Trial 125/2 F&R  
201/301 Monoshock 86 F  
243 Trial 87- F&R  
303 Monoshock 87 F&R

## GARELLI

50 Tiger XLE 86- R

## GILERA

Eaglet 50 96 F  
Built 50 90- F  
503 50cc 91- F&R

## MALAGUTI

Phantom F12 94-98 F  
Crosser CR1 97 F  
50 Enduro RCX-W/Sahib 83- F  
50 Fifty Full/CX 83- F  
50 RGT Strada 83- F  
50 Enduro Dune 87- F&R  
50 Fifty Top 85- F  
50 RGT Sport 85- F  
50 RST Sport 87- F&R  
50 Evolution 91- F  
50 Raid 91- F

# FA100 39 x 9mm



## LAMBRETTA

All disc models F

### Equivalents OE #

14744200

### Competitor X Ref

| Dunlop | Ferodo | SBS | Vesrah |
|--------|--------|-----|--------|
| -      | -      | -   | -      |

### MATERIAL AVAILABILITY AND PART NO.

| STD   | OPTIONS |   |     |     |
|-------|---------|---|-----|-----|
| FA    | HH      | R | MXS | GFA |
| FA100 | -       | - | -   | -   |

# FA101 71 x 36 x 9.2mm

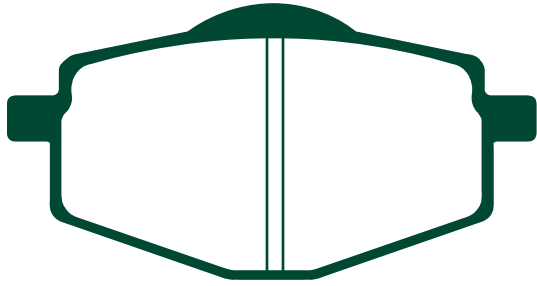

**BETA**

Euro/Jonathan 350 03-06 R

**HERO**

Quickster 125 06 F

**HONDA HM (Italy)**

CRE 50 Six/Baja/Derapage 95-02 R

**MBK**

TZR 50 X-Power 00 R

XC 125 Flame 125 96-03 F

XC 150 Vertex 97 F

**MZ**

660 SSR 95 R

**YAMAHA**

TZR 50 'Thunderkid' (5DU1/3) 97-00 R

YSR 50 T 87 F

DT 80 LC-2 (53V) 85-92 F

DT 125 LC 86-87 F

DT 125 R 88-03 F&R

DT 125 RE 04 F&R

DT 125 RE 05-07 F

TDR 125 R 93-03 R

YBR 125 ED (3D91) 05-07 F

YZ 125 U 88 R

XC 125 TR "Cygnus" 96-03 F

**YAMAHA Contd.**

DT 200 (2LR) 87 F

XT 225 W (4JG1-6 Serrow) 93-98 F

XT 225 (2LN) Serrow (1KH 020101-) 86-87 F

XT 225 (3RW1-5 Serrow) 89-93 F

(1KH 034101-132000) 88 R

YZ 250 U 85-86 F&R

YZ 250 N/S "TRI-Z" 85-95 F

XT 350 87 R

XT 600 88-90 R

XT 600 Z "Tenere" 92-03 R

XT 600 E 91-98 R

XTZ 660 E "Tenere" 91- R

**GILERA**

125 Apache 07 F

Oregon 250 Quad 89-90 R

RC 600 00-01 F

Millennium 100/125/150 00-01 F

**SACHS**

Roadster 650 05 R

**SIAMOTO**

KD 125 00-04 F

**Equivalents OE #**

|              |              |              |
|--------------|--------------|--------------|
| 1UY W0045 00 | 34X W0046 02 | 3JH W0045 00 |
| 1UY W0045 01 | 38W W0045 00 | 3UH W0045 00 |
| 1UY W0045 02 | 38W W0045 01 | 344 840      |
| 1UY W0045 03 | 3BN W0045 00 | 48 7100 7    |
| 2VN W0046 00 | 3BN W0045 01 | 4KL F5811 00 |
| 2VN W0046 01 | 3FY W0045 00 | KA3495506    |
| 34X W0046 00 | 3XP W0045 00 |              |
| 34X W0046 01 | 3XP W0046 00 |              |

**Competitor X Ref**

|               |               |            |               |
|---------------|---------------|------------|---------------|
| <b>Dunlop</b> | <b>Ferodo</b> | <b>SBS</b> | <b>Vesrah</b> |
| DP406         | FDB383        | 575/619    | VD-239        |

**MATERIAL AVAILABILITY AND PART NO.**

| STD   | OPTIONS |    |        |        |     |
|-------|---------|----|--------|--------|-----|
| FA    | TT      | HH | R      | MXS    | GFA |
| FA101 | FA101TT | -  | FA101R | MXS101 | -   |

# FA102 58 x 48 x 8.7mm

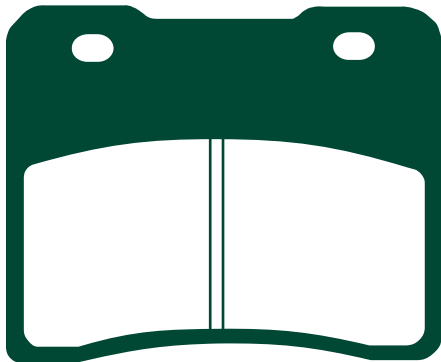

**SUZUKI**

RG 250 WE/FG/CH/FCH/FH 'Gamma' 84-88 F

GSX 400 R2 (GK71B) F

**Equivalents OE #**

|             |             |
|-------------|-------------|
| 59130 04A00 | 59100 04830 |
| 59130 04A10 |             |

**Competitor X Ref**

|               |               |            |               |
|---------------|---------------|------------|---------------|
| <b>Dunlop</b> | <b>Ferodo</b> | <b>SBS</b> | <b>Vesrah</b> |
| -             | FDB390        | 578        | VD-328        |

**MATERIAL AVAILABILITY AND PART NO.**

| STD   | OPTIONS |   |     |     |
|-------|---------|---|-----|-----|
| FA    | HH      | R | MXS | GFA |
| FA102 | -       | - | -   | -   |



# FA103 58 x 53.5 x 8.7mm

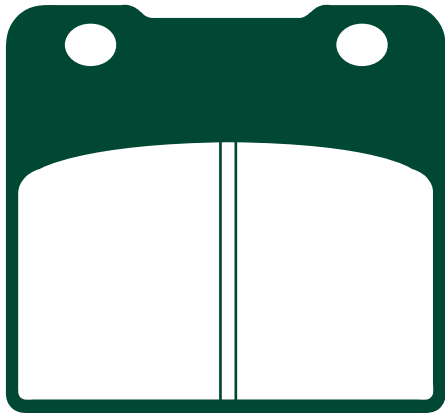

### Equivalents OE #

|             |             |             |
|-------------|-------------|-------------|
| 59100 10810 | 59130 06B20 | 69100 38840 |
| 59100 20810 | 59130 00810 | 69100 38860 |
| 59100 20820 | 59130 24A00 | 69100 38870 |
| 59100 30810 | 59130 27A00 | 69100 48810 |
| 59100 06820 | 59130 27A10 | 69130 38B10 |
| 59100 30820 | 59130 30B00 | 69130 38B00 |
| 59100 38820 | 59130 30B01 | 69130 48B00 |
| 59130 00A00 | 59130 30B21 | 69130 38820 |
| 59130 00A10 | 69100 38810 | 69130 48810 |
| 59130 06B10 | 69100 38820 |             |

### SUZUKI

|   |       |     |
|---|-------|-----|
| GSX 250 R CH/H (GJ72A)                      |       | F   |
| GSXR 250 J (GJ72A)                          |       | F   |
| GSXR 250 CK                                 |       | F   |
| GSXR 400 H                                  | 87    | F   |
| GSX 400 X/XA/XS "Impulse"                   |       | F   |
| GSX 400 R3 (GK71F)                          |       | F   |
| RG 400                                      |       | F   |
| RG 400 EWF/EW-2G/EWH Walter Wolf (Type 1&2) | 85-87 | F   |
| VS 400 VR/FR/VTR/FTR/V-T/F-T                | 94-   | F   |
| RG 500 G/CH                                 | 85-87 | F   |
| VS 600 GLS/GLT                              | 95-96 | F   |
| VS 700 GLEFG/GLEPG/GLEFH/GLEPH              | 86-87 | F   |
| VS 700 GLFH/GLPH/GLFG/GLPG                  | 86-87 | F   |
| GSXR 750 F/G/H                              | 85-87 | F   |
| VS 750 All models                           | 85-91 | F   |
| VS 800 GLN/GLP/GLR/GLT/GLS/GLV/GLW/GLX      | 92-99 | F   |
| GSX 1100 EFE/EF/ESF                         | 84-86 | F&R |
| GSX 1100 FJ/FK/FL/FM/FN/FP                  | 88-93 | F   |
| GSXR 1100 G/H/J                             | 86-88 | F   |
| GV 1400 GDG/GTG Cavalcade                   | 86    | F&R |
| VS 1400 GLPH/GLFH/GLPJ/GLFJ/GLPR/GLPT/GLPV  |       |     |
| /GLPW/GLPX/GLPY/GLPK1/GLPK2 Intruder        | 87-03 | F&R |
| VL 1500 W/X/Y/K1                            | 98-01 | F&R |

### Competitor X Ref

| Dunlop | Ferodo   | SBS | Vesrah             |
|--------|----------|-----|--------------------|
| DP210  | FDB389/R | 577 | VD-330/<br>331/338 |

### MATERIAL AVAILABILITY AND PART NO.

| STD   | OPTIONS |   |     |     |
|-------|---------|---|-----|-----|
| FA    | HH      | R | MXS | GFA |
| FA103 | FA103HH | - | -   | -   |

# FA104 68 x 56.2 x 8.8mm

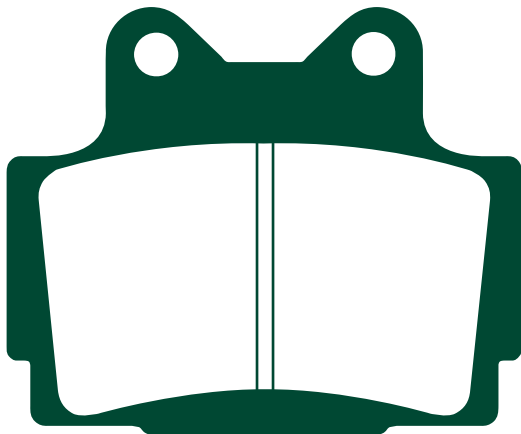

### Equivalents OE #

|              |              |              |              |
|--------------|--------------|--------------|--------------|
| 1KT W0046 50 | 1KT W0046 52 | 51L W0046 00 | 51L W0046 02 |
| 1KT W0046 51 | 3TJ W0046 00 | 51L W0046 01 | 4AP W0046 00 |

### Competitor X Ref

| Dunlop | Ferodo   | SBS | Vesrah |
|--------|----------|-----|--------|
| DP407  | FDB386/R | 570 | VD-240 |

### MATERIAL AVAILABILITY AND PART NO.

| STD   | OPTIONS |   |     |     |
|-------|---------|---|-----|-----|
| FA    | HH      | R | MXS | GFA |
| FA104 | FA104HH | - | -   | -   |

### YAMAHA

|                               |       |     |
|-------------------------------|-------|-----|
| RD 125 LC (MK 2-3)            | 85-87 | F   |
| RZ 125 (1GV 030101-)          | 85    | F   |
| TZR 125                       | 87-89 | F   |
| TZR 125                       | 90-92 | R   |
| TZR 125 R                     | 93-   | R   |
| TZR 150 R (4AP2)              | 00    | R   |
| SDR 200 (2TV)                 | 87-89 | F&R |
| FZR 250 R                     |       | R   |
| FZR 250                       | 87    | R   |
| FZX 250 Zeal (3YX1/2/4)       | 91-92 | R   |
| RZ 250 R (1AR/1XG)            |       | F&R |
| RZ 250 R (29L)                |       | R   |
| RZ 250 RR (51L)               |       | F&R |
| SRX 250                       |       | F   |
| TDR 250                       | 88-92 | R   |
| TZR 250 (2MA/2XW)             | 87-92 | R   |
| TZR 250 (3MA1)                | 89    | R   |
| TZR 250 (3MA3/A5)             | 90    | R   |
| TZR 250 SP (3MA4)             | 90    | R   |
| TZR 250 R (3XV1/4/6)          | 91    | R   |
| TZR 250 R (3XV8/9)            | 92-94 | R   |
| TZR 250 (1KT/2AW)             | 87    | R   |
| RD 350 N                      | 85    | F&R |
| RD 350 F/F2                   | 85-92 | F&R |
| RD 350 R                      | 92-95 | F&R |
| RIZ 350                       | 92    | R   |
| FZ 400 N (IFK 146X 133M)      | 85    | R   |
| FZR 400 RR (4DX)              | 92    | R   |
| FZR 400 (3TJ1/2/6/7)          |       | R   |
| FZR 400 Genesis (1WG)         | 86    | R   |
| FZR 400 RSP (2TK EX-UP)       | 87    | R   |
| FZR 400 (3EN1/2)              | 88-89 | R   |
| SRX 400 (1JL)                 | 85    | R   |
| SRX 400 (3VN1/3VN2/3VN5)      | 90-96 | R   |
| XJR 400 (4HM1/4HM2/4HM4/4HM7) | 93-96 | R   |
| XJR 400 (4HM3/4HM5/4HM6/4HM9  |       |     |
| /4HMA/4HMB) Brembo caliper    | 95-99 | R   |
| RD 500 LC                     | 84-86 | R   |
| FZ 600                        | 87-88 | R   |
| FZS 600 Fazer                 | 98-03 | R   |
| SRX 600                       | 86-87 | F&R |
| SRX 600 (1JK)                 | 85    | F&R |
| SRX 600 (3SX)                 | 90-91 | R   |
| XJ 600 N                      | 95-03 | R   |
| XJ 600 S "Diversion"          | 92-03 | R   |

# FA105 91 x 30.4 x 8mm

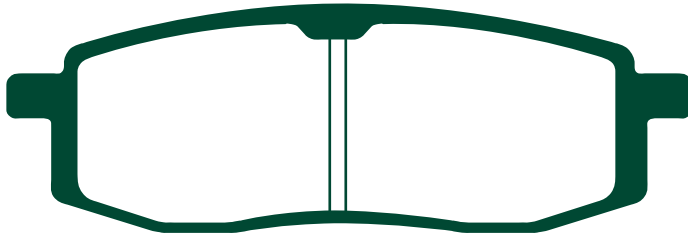

### YAMAHA

|                         |       |   |
|-------------------------|-------|---|
| YZ 125 N/S/T/U          | 85-88 | F |
| TT 250                  | 90    | F |
| YZ 250 N/S/T/U          | 85-88 | F |
| TT 350 A (3GJ)          | 90-95 | F |
| YZ 490 N/S/T/U          | 85-88 | F |
| TT 600 W (59X/2JT/3SW1) | 89-92 | F |

### Equivalents OE #

|              |              |
|--------------|--------------|
| 56A W0046 00 | 2HH W0045 00 |
| 1LN W0045 01 | 2HH W0045 01 |
| 1LX W0045 00 |              |

### Competitor X Ref

| Dunlop | Ferodo | SBS | Vesrah |
|--------|--------|-----|--------|
| DP405  | FDB411 | 580 | VD-241 |

| MATERIAL AVAILABILITY AND PART NO. |         |        |     |     |
|------------------------------------|---------|--------|-----|-----|
| STD                                | OPTIONS |        |     |     |
| FA                                 | HH      | R      | MXS | GFA |
| FA105TT                            | -       | FA105R | -   | -   |

# FA106 77 x 54 x 7mm

## FA106/2 77 x 54 x 9.5mm

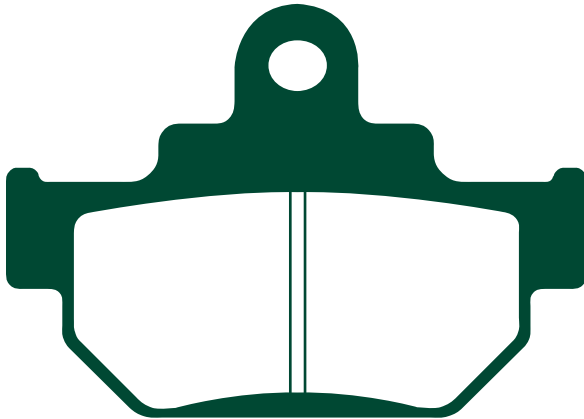

### SUZUKI

|  |          |   |
|--|----------|---|
| GZ 125 W/X/Y/K1-K7 'Marauder'          | 98-07    | F |
| RM 125/250 F/G                         | 85-86    | F |
| TU 125 X Super Classic                 | 99       | F |
| VL 125 Y/K1/K2/K3/K4/K5/K6/K7 Intruder | 00-07    | F |
| TU 250 XV/XW                           | 97-00    | F |
| TU 250 S/T/XS/XT/X-ST/XSV              |          |   |
| /XT-W (NJ47A 10001-115972)             | 92-97    | F |
| VL 250 Y/K1/K5 Intruder                | 00-01/05 | F |
| LS 650 "Savage" FG/PK/PM/              |          |   |
| PR/PG/PT/PV/PW/PX                      | 87-99    | F |

### SIAMOTO

|          |    |   |
|----------|----|---|
| Geco 250 | 04 | F |
|----------|----|---|

### MAICO

|            |       |     |
|------------|-------|-----|
| All Models | 86-88 | F&R |
|------------|-------|-----|

### FA106/2 - SUZUKI

|                       |       |   |
|-----------------------|-------|---|
| DR 600 SF/RG/RH/SG/SH | 85-87 | F |
|-----------------------|-------|---|

### Competitor X Ref

| Dunlop | Ferodo     | SBS     | Vesrah           |
|--------|------------|---------|------------------|
| DP405  | FDB404/673 | 581/582 | VD-329/<br>329/2 |

| MATERIAL AVAILABILITY AND PART NO. |         |        |     |     |
|------------------------------------|---------|--------|-----|-----|
| STD                                | OPTIONS |        |     |     |
| FA                                 | HH      | R      | MXS | GFA |
| FA106TT                            | -       | FA106R | -   | -   |

| MATERIAL AVAILABILITY AND PART NO. |         |          |     |     |
|------------------------------------|---------|----------|-----|-----|
| STD                                | OPTIONS |          |     |     |
| FA                                 | HH      | R        | MXS | GFA |
| FA106/2TT                          | -       | FA106/2R | -   | -   |

### Equivalents OE # - FA106

|             |
|-------------|
| 59300 24830 |
| 59340 14600 |
| 59340 24B00 |
| 59340 24B10 |

### Equivalents OE # - FA106/2

|             |
|-------------|
| 59300 14830 |
| 59340 14500 |
| 59340 14501 |
| 59340 14510 |

# FA107A 82 x 54 x 8mm

## FA107/2A 82 x 54 x 7mm

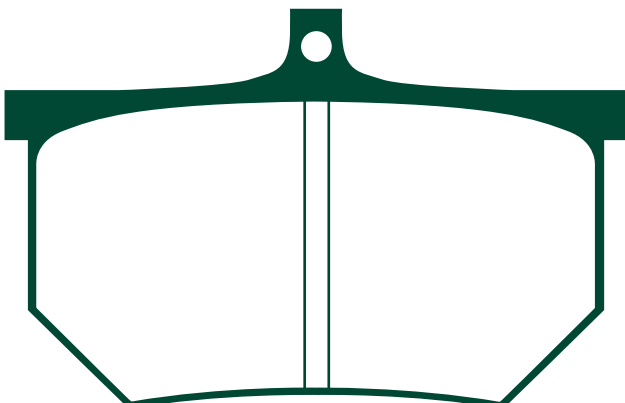

### FA107A - LOCKHEED/SPONDON

4 Piston Caliper CP4484/3369

### FA107/2A - LOCKHEED/SPONDON

4 Piston Caliper CP4484

### Competitor X Ref

| Dunlop | Ferodo | SBS | Vesrah |
|--------|--------|-----|--------|
| DP624  | FRP410 | 661 | -      |

| MATERIAL AVAILABILITY AND PART NO. |         |   |     |     |
|------------------------------------|---------|---|-----|-----|
| STD                                | OPTIONS |   |     |     |
| FA                                 | HH      | R | MXS | GFA |
| FA107A                             | -       | - | -   | -   |

| MATERIAL AVAILABILITY AND PART NO. |         |   |     |     |
|------------------------------------|---------|---|-----|-----|
| STD                                | OPTIONS |   |     |     |
| FA                                 | HH      | R | MXS | GFA |
| FA107/2A                           | -       | - | -   | -   |

# FA109 50 x 55 x 11.3mm

**HONDA**  
VF 1000 RE/RF/RG

84-86 R

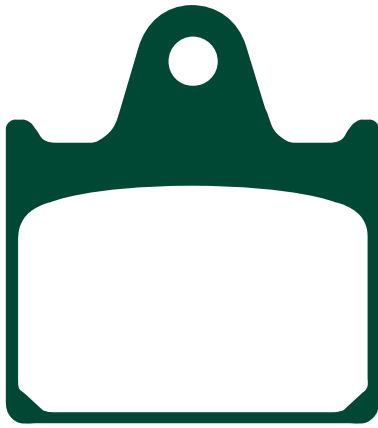

**Equivalents OE #**

|               |
|---------------|
| 43105 MJ4 007 |
| 43105 MJ4 008 |

**Competitor X Ref**

| Dunlop | Ferodo | SBS | Vesrah |
|--------|--------|-----|--------|
| -      | -      | 573 | VD-258 |

| MATERIAL AVAILABILITY AND PART NO. |         |   |     |     |
|------------------------------------|---------|---|-----|-----|
| STD                                | OPTIONS |   |     |     |
| FA                                 | HH      | R | MXS | GFA |
| FA109                              | -       | - | -   | -   |

# FA110 52.5 x 44.5 x 7.2mm

**SUZUKI**  
RG 125 (All Models)

85-91 F

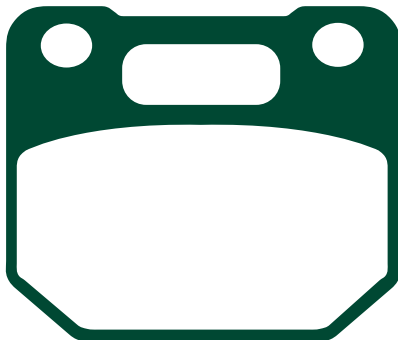

**Equivalents OE #**

|             |
|-------------|
| 59100 36850 |
| 59130 36A00 |
| 59130 36A01 |

**Competitor X Ref**

| Dunlop | Ferodo | SBS | Vesrah |
|--------|--------|-----|--------|
| -      | FDB437 | 587 | VD-335 |

| MATERIAL AVAILABILITY AND PART NO. |         |   |     |     |
|------------------------------------|---------|---|-----|-----|
| STD                                | OPTIONS |   |     |     |
| FA                                 | HH      | R | MXS | GFA |
| FA110                              | -       | - | -   | -   |

# FA111 64 x 57 x 9mm

**HONDA**  
FL 350 R Odyssey  
FL 400 R/RK/RL "Pilot"

85-87 R  
89-93 R

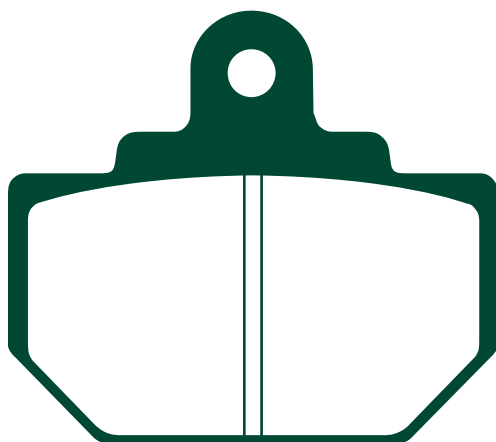

**Equivalents OE #**

|               |               |
|---------------|---------------|
| 43105 HE0 305 | 431A0 HE0 670 |
| 43105 VM0 008 | 431A0 VMO 008 |
| 43105 VM0 771 |               |

**Competitor X Ref**

| Dunlop | Ferodo | SBS | Vesrah |
|--------|--------|-----|--------|
| DP813  | -      | 610 | VD-931 |

| MATERIAL AVAILABILITY AND PART NO. |         |        |     |     |
|------------------------------------|---------|--------|-----|-----|
| STD                                | OPTIONS |        |     |     |
| FA                                 | HH      | R      | MXS | GFA |
| FA111                              | -       | FA111R | -   | -   |

# FA113 78.7 x 47 x 7.4mm

**USE FA256**

# FA115 36 x 45 x 6mm

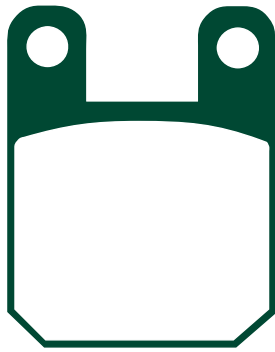

**NOTE: AJP Caliper**

## Competitor X Ref

|                        |                         |                   |                                 |
|------------------------|-------------------------|-------------------|---------------------------------|
| <b>Dunlop</b><br>DP607 | <b>Ferodo</b><br>FRP405 | <b>SBS</b><br>559 | <b>Vesrah</b><br>VD-254/<br>925 |
|------------------------|-------------------------|-------------------|---------------------------------|

## Equivalents OE #

|               |                |              |                |               |
|---------------|----------------|--------------|----------------|---------------|
| 3380925       | 753092         | 00G04700141  | KA3497506      | 11955600      |
| 3380928       | 753200         | 00H01301931  | K00996315      | 2133071000019 |
| 3499074       | 59330 06E00    | 00D01210221  | 5WX W0045 10   | K00996315     |
| 8113181       | 45105 NN2 900  | 213307100003 | R051           | 00H01303551   |
| 510 015 4 282 | ODN00G04700141 | P150442      | 460 13 016 000 |               |
| 4AJ W0045 00  | 812732         | 2525350000   | 00009300060    |               |
| 737786        | 2525241000     | 2525241000   | 0009307001     |               |
| 752816        | 2525350000     | 59300 06E00  | EJ29099074     |               |

## MATERIAL AVAILABILITY AND PART NO.

| STD   |         | OPTIONS |        |        |     |
|-------|---------|---------|--------|--------|-----|
| FA    | TT      | HH      | R      | MXS    | GFA |
| FA115 | FA115TT | FA115HH | FA115R | MXS115 | -   |

DISC PADS BUYERS GUIDE

| Brand            | Model                            | Year         | Caliper | Disc Part No.                   | Year  | Caliper | Disc Part No.                    |
|------------------|----------------------------------|--------------|---------|---------------------------------|-------|---------|----------------------------------|
| <b>ALFER</b>     | 80 MC                            | 87-          | R       | <b>DERBI Contd.</b>             |       |         |                                  |
| <b>APRILIA</b>   | RS 50 (Radial Caliper)           | 07           | R       | GPR 50-R/Replica                | 98-04 | R       | HUSQVARNA Contd.                 |
|                  | RX 50                            | 07           | R       | GPR 50/Nude ST (Radial caliper) | 04-07 | R       | Husky Boy R                      |
|                  | SX 50                            | 07           | R       | Predator/Replica                | 98-02 | F&R     | WRS 50 Scooter                   |
|                  | TX 125/240/311                   | 86-88        | F       | Atlantis 50/100                 | 99-05 | F       | WR 50                            |
|                  | TX 311                           | 88           | F&R     | DRD 50 Supermoto                | 03-04 | F&R     | SM 50                            |
|                  | 280 Climber                      | 94-96        | F       | Super Motard                    | 01    | F&R     | <b>IRON PEGASUS</b>              |
|                  | 280 R Climber                    | 92-93        | F       | SM 50 DRD Edition               | 05    | R       | Small caliper                    |
| <b>BETA</b>      | RR 50 Supermoto/Enduro           | 98-05        | F&R     | GPR 125/Nude (Radial caliper)   | 05-06 | R       | <b>ITALJET</b>                   |
|                  | RR Enduro Alu 50/Motard Aly 50   |              |         | Terra 125                       | 07    | R       | Formula 50 LC                    |
|                  | /RR Enduro 50                    | 04-07        | R       | Mulhacen 125                    | 07    | R       | Formula Air 50                   |
|                  | Eickon 50                        | 99-06        | F&R     | <b>ECO</b>                      |       |         | Torpedo 50                       |
|                  | 50 RR Enduro                     | 97-04        | F&R     | Bushman 150 (LX 150 GY)         |       | R       | Torpedo 125 4T                   |
|                  | Pro race 50                      | 05           | F       | <b>EXPLORER</b>                 |       |         | Formula 125 LC                   |
|                  | Rev 50/80                        | 00-07        | F&R     | KBR 200                         | 05    | R       | Dragster 50                      |
|                  | Synt/Gara                        | 93-95        | F       | <b>FACTORY</b>                  |       |         | Dragster 125/180 LC              |
|                  | Zero                             | 92           | F       | RP 50                           | 05    | R       | Dragster 250                     |
|                  | Super Trial ST                   | 94           | F       | YM 50                           | 05    | R       | 07 F&R                           |
|                  | Techno                           | 95           | F       | YR 50 Desert                    | 02-03 | F&R     | <b>JAYBRAKE</b>                  |
|                  | Eurotek/Techno 125/250           | 96-98        | F&R     | YR 50 Desert                    | 04-05 | R       | 2 Piston (Small)                 |
|                  | 125 TR 34                        |              |         | Chrono SM 50                    | 04    | R       | <b>JCM</b>                       |
|                  | Synt                             | 92           | F       | YR 125 4T                       | 05    | R       | 240 Europa                       |
|                  | RK6 50cc Enduro                  | 97-02        | R       | <b>FANTIC</b>                   |       |         | <b>KTM</b>                       |
|                  | Alp 4T 125/200                   | 00-04        | F&R     | 50.5 Trial                      | 89    | F&R     | 60 SX                            |
| <b>BLATA</b>     | Enduro 125                       | 07           | R       | 50.7 Trial                      | 90    | F&R     | 65 SX                            |
|                  | Motard 125                       | 07           | R       | 50.9 Trial                      | 91-   | F&R     | <b>MALAGUTI</b>                  |
| <b>CAGIVA</b>    | Mito 50                          | 99-00        | R       | 50 Clubman                      | 95-   | F&R     | NDK 50 Drakon                    |
|                  | Progress 50                      | 97-99        | F       | 80 Clubman                      | 95-   | F&R     | XTM 50                           |
| <b>CH RACING</b> | WXE 50 Enduro                    | 05           | R       | 125/5/245/305                   | 89    | F&R     | XSM 50                           |
|                  | WSM 50 Motard                    | 05           | R       | Series 7 Models                 | 90    | F&R     | Drakon S                         |
|                  | WXE 125 Enduro                   | 05           | R       | K-Roo (All Models)              | 92-95 | F&R     | <b>MBK</b>                       |
|                  | WSM 125 Motard                   | 05           | R       | 309                             | 92    | F&R     | TZR 50 X Power                   |
| <b>CONTI</b>     | RX 356 V3 (12" wheels)           | 05-06        | R       | Section 125/249 R               | 95-   | F&R     | <b>MH (MOTOR HISPANIA)</b>       |
|                  | RX 356 V3 (17" wheels)           | 05-06        | R       | <b>FB MINARELLI (SPAIN)</b>     |       |         | RYZ 50 SM                        |
| <b>CP</b>        | Supermoto 50 SMX                 | 03-07        | F&R     | MR 80                           |       | F       | RYZ 50 Enduro                    |
|                  | Supercross 50                    | 03-06        | F&R     | <b>FYM/X-Sport</b>              |       |         | Furia 6v                         |
|                  | SX 50                            | 06-07        | R       | CR 110                          | 06-07 | R       | RX 50 Super Racing               |
| <b>CZ/JAWA</b>   | S 125                            | 03           | R       | CR 110 ESR                      | 06-07 | R       | Arena 125                        |
|                  | 125 Sport                        | 03-04        | F&R     | CR3 125                         | 06-07 | R       | Furia Max Enduro                 |
|                  | 125 Dandy                        | 03-04        | F&R     | CR 125 R                        | 06-07 | R       | Furia Max Supermotard            |
|                  | 50/100 Robby                     | 03-04        | F       | X Sport Typhoon 125 Quad        | 06-07 | R       | RYZ 50 Pro Racing Enduro         |
| <b>DAELIM</b>    |                                  |              |         | <b>GARELLI</b>                  |       |         | RYZ 50 Racing Super Motard       |
|                  |                                  |              |         | Sahel 50                        | 91-   | R       | RYZ 50 Pro Racing Urban Bike     |
| <b>DERBI</b>     |                                  |              |         | Sahel 80                        | 91-   | R       | Arena 125 Pro Racing Supermotard |
|                  | Atlantis 50 LC/City/Bullet       | 02-06        | F       | Trial 323                       | 86-   | F       | Arena 125 Pro Racing Urban Blue  |
|                  | Atlantis 50 City/Bullet/Two Chic |              |         | <b>GAS-GAS</b>                  |       |         | RYZ 50 Supermotard               |
|                  | (4T) 13" wheels                  | 04-07        | F       | EC 50 Boy (Air cooled)          | 05    | F       | <b>MONTESA</b>                   |
|                  | X Race 50                        | 06           | F&R     | K 50 Quad                       | 06    | R       | Cota 307/335                     |
|                  | GPX1                             | 06           | R       | Boy 50                          | 06-07 | F       | 311 (Honda)                      |
|                  | Red Bullet 50                    | 04-05        | F       | TXT 50 (Boy)                    | 04-07 | F&R     | 314 R (Honda)                    |
|                  | Senda R DRD                      | 04-05        | R       | MC 65                           | 05    | R       | 315 R (Honda)                    |
|                  | GP-I 50                          | 01-Feb       | 05      | Contact Models                  | 93-95 | F&R     | <b>MOTO ROMA</b>                 |
|                  | F&R                              |              |         | JTX 125/200/270/320             | 95-98 | F&R     | SMX 125                          |
|                  | GP-I 50 Open                     | 06-07        | R       | Pampera 125/250/370             | 96-97 | F&R     | <b>PERFORMANCE MACHINE</b>       |
|                  | GP-I 150                         | 05           | R       | TX 200/270/320                  | 98    | F&R     | 125X4S                           |
|                  | GPI Scooter (Radial caliper)     |              |         | Pampera 250/320                 | 98-99 | F&R     | 125X4SL                          |
|                  | (Euro 2)                         | Mar 05-Dec05 | R       | Contact JT25 (238cc)            | 93-94 | F&R     | <b>SUZUKI</b>                    |
|                  | Senda SM DRD Super Motard        | 04           | F&R     | 250 Pampera                     | 96-97 | F&R     | RMX 50                           |
|                  | Senda-R                          | 96-02        | F&R     | JTR/125/160/250/370             | 96-97 | F&R     | AY 50 WRX/WX/WRY/WY/WRK1/WRK2    |
|                  | Senda 50 DRD Pro SM Supermoto    | 05-07        | R       | TX 200/270/320                  | 98    | F&R     | /WRK3/WRK4 "Katana"              |
|                  | Senda R Euro2                    | 04-07        | R       | <b>GILERA</b>                   |       |         | AY 50 WRK1/WRK2/K3/WRK3/WRK4     |
|                  | Senda R Baja Enduro              | 06-07        | R       | GSM 50                          | 00-03 | F&R     | AK5 (AJP Caliper)                |
|                  | Senda R Baja Supermoto           | 06-07        | R       | H@K 50                          | 01-02 | F&R     | UF 50 Y "Estilete"               |
|                  | Senda X Race SM Supermoto        |              |         | RCR 50 Enduro                   | 03-06 | F&R     | <b>PEUGEOT (AJP CALIPER)</b>     |
|                  | (260mm front disc)               | 03-07        | F&R     | RK 50 Cannibal                  | 96-98 | F&R     | Elyseo 50                        |
|                  | Senda X-treme SM Supermoto       |              |         | SMT 50 Supermotard              | 03-06 | F&R     | Elyseo 50                        |
|                  | (260mm front disc)               | 03-07        | F&R     | SMT 50                          | 07    | F&R     | Elystar 50 TSDi/Advantage        |
|                  | Senda 50 DRD Racing R Enduro     | 04-07        | R       | Zulu 50                         | 01-01 | F&R     | Ludix Snake 50cc                 |
|                  | Senda 50 DRD Racing SM Supermoto | 04-07        | R       | SC 125                          | 06-07 | R       | Ludix Bullet 50cc                |
|                  | Senda 50 X-Race R Enduro         |              |         | <b>GMA</b>                      |       |         | Ludix Trend 50cc                 |
|                  | (240mm front disc)               | 03-07        | F&R     | 4 Piston model                  |       |         | Ludix Elegance 50cc              |
|                  | Senda 50 X-treme R Enduro        |              |         | <b>HONDA DALL-ARA</b>           |       |         | XPS Street 50                    |
|                  | (240mm front disc)               | 03-07        | F&R     | XR 125 SM                       | 04    | R       | Elyseo 100                       |
|                  | Vamos/Vamos FL                   | 96-99        | F       | <b>HONDA HM (Italy)</b>         |       |         | Elyseo 125/150                   |
|                  | Hunter                           | 96-99        | F       | CRE 50 Baja/Derapage            | 01-02 | R       | Ludix Ambition 125cc             |
|                  |                                  |              |         | <b>HRD</b>                      |       |         | XP 6 Trail 50                    |
|                  |                                  |              |         | Cabriolet 125                   | 01    | R       | XPS-6 Supermotard                |
|                  |                                  |              |         | Sonic 2 Trail 50                |       | R       | Speedfight 50/100                |
|                  |                                  |              |         | Sonic 2 Supermotard 50          |       | R       | All models                       |
|                  |                                  |              |         | Cabriollet Trail 125            |       | R       | Squab                            |
|                  |                                  |              |         | Cabriollet Supermotard 125      |       | R       | Street Board/Trekker             |
|                  |                                  |              |         | <b>HUSQVARNA</b>                |       |         | TKR (All)                        |
|                  |                                  |              |         | Husky Boy J                     | 01-02 | F       | Vivacity 50/100 (All models)     |
|                  |                                  |              |         | Husky Boy S                     | 01-02 | F       | LOOXOR 50                        |
|                  |                                  |              |         |                                 |       |         | LOOXOR 100                       |

# FA115 Contd.

## PEUGEOT (AJP CALIPER) Contd.

Metal X 50  
XR6 '50cc'  
XP6 Enduro 50  
Elyseo 100  
LOOXOR 125/150  
Elystar 50 TSDI  
Jet Force 50  
Ludix Urban Track  
Ludix Red Zone  
Ludix Acid  
Looxor 50 TSDI (Rear disc)  
XPS 125 CT  
Ludix Blaster  
XP 125 Street Evo 2  
**PGO**  
RS2 NKD  
**PIAGGIO**  
Diesis 50  
Diesis 100  
**RIEJU**  
MRX 50  
NKD 50  
RS1 50cc  
RR 50 cc Thunderfire

02-03 F  
02-07 R  
02-07 F&R  
03 F&R  
03-06 R  
02-05 F  
03-06 F&R  
06-07 F  
06 F  
06 F  
06 F&R  
05-07 F&R  
05-07 F  
05 R  
05 R  
01-05 F  
01-03 F  
03-06 F&R  
07 R  
97-00 F&R  
97-02 F&R

**RIEJU Contd.**  
RR 50 Castrol  
RR 50 Sport  
MRX 50 PRO  
Spike 50  
Spike 50 Pro  
SMX 50 Pro Supermotard/Top  
RS1 50cc  
SMX 50  
MRX 50 Castrol/SMX 50  
RS2 125  
125 NKD  
SMX 125  
MRX 125  
RS2 Matrix  
Spike X50  
RRX 50  
**ROXON**  
Duel 50 SM  
Duel 50 TT  
**SACHS**  
Madass 50 (2 stroke) (Hydraulic rear brake)  
**SCORPA**  
250 Easy

00-02 R  
03-06 F&R  
04-06 R  
04-06 F&R  
04 R  
04-07 R  
01-04 R  
02-06 F&R  
01-02 R  
06-07 R  
06-07 R  
02-07 R  
02-07 R  
02-07 R  
06-07 F&R  
06-07 F&R  
06 F&R  
06 F&R  
04-05 R  
96 F&R

**SCORPA Contd.**  
TY-S 125 F Enduro  
TYS 125 F  
TY-S 175 F  
**SHERCO**  
All models 0.5-2.0  
All models 1.2-2.0  
SM 50 Supermotard  
Enduro 50 (EN 50)  
SM 125/125 City Corp  
0.8  
**SIAMOTO**  
SX1 125  
**TOMOS**  
Streetmate  
SM 125  
SE 50/125  
Youngst'r  
**VECTRIX**  
Vectrix Electric 3W (MP3 style scooter)  
**YAMAHA**  
TZR 50 (5WX1)  
TY 250 R  
TY 250 R  
TYZ 250 R

03-05 F&R  
06-07 F  
06 F  
01-05 F  
01-05 R  
03-07 R  
03-07 R  
03-06 R  
01-05 F  
04 R  
05 F  
05 R  
05 R  
05 F  
07 F  
03-07 R  
91-92 F  
93-94 F&R  
93-96 F&R

# FA116 31.5 x 57.2 x 5.5mm

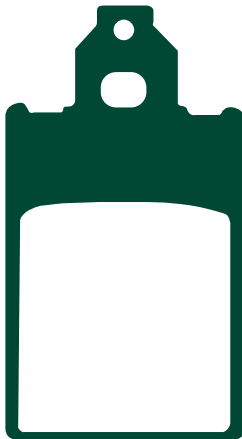

## ACCOSSATO

CE 50/80/KR 80  
Enduro Codice 50

## BETA

TR34  
TR34 125  
Tempo 16"

## TR34

Tempo

## RK6

## CAGIVA

W4 50

## FANTIC

50.1 Oasis

50.1 Oasis KS/Rally

50.1 Oasis E.S.

50 Fast

## GARELLI

Sahel 50  
Sahel 80

87- R  
89- R  
86-88 R  
86- R  
94-97 F  
98 F  
93-96 R  
91-95 F  
86- F  
86- F  
87- F  
88- F  
91- F  
91- F

## MALAGUTI

50 Enduro MLX

Yesterday

F15 Firefox

Centro SL/SL Cat

CRI Crosser

Centro Base

F12 Phantom 50

## PEUGEOT

SV 100 L

## PIAGGIO

Free 50 (Disc Model)

Free Delivery 50

## TOMOS

Streetmate

Revival/Revival TS

## YAMAHA

DT 50 R

DR 50 R-L (SM-5VB1/VG55BK)

87- F  
98-03 F  
96-00 F  
94-00 F  
95-98 F  
94-03 F  
95-00 F  
00-01 F  
03-04 F  
03-04 F  
97-01 F  
02-03 F

### Equivalents OE #

|              |
|--------------|
| 119 363 00   |
| 5BK F5811 00 |
| 821 3145     |
| 498840       |
| 119 468 000  |
| 119 419 000  |
| 752817       |
| 2525250000   |

### Competitor X Ref

| Dunlop | Ferodo | SBS | Vesrah |
|--------|--------|-----|--------|
| DP610  | FDB697 | 607 | VD-937 |

### MATERIAL AVAILABILITY AND PART NO.

| STD   | OPTIONS |   |     |     |
|-------|---------|---|-----|-----|
| FA    | HH      | R | MXS | GFA |
| FA116 | -       | - | -   | -   |

# FA118 71 x 38.8 x 10mm

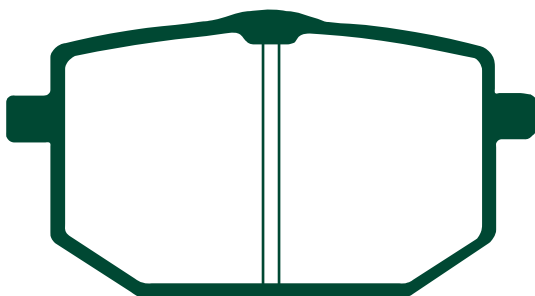

## ALFER

VRE 125 4T

Divertida 250 Super Motard

Diferente Enduro

VR 250

## YAMAHA

XT 600

XT 600 (Z Tenere)

98- F  
01- F  
01- F  
98- F

87 F  
85-90 F

### Equivalents OE #

|              |
|--------------|
| 55W W0045 00 |
| 55W W0045 01 |

### Competitor X Ref

| Dunlop | Ferodo | SBS | Vesrah |
|--------|--------|-----|--------|
| -      | FDB583 | 596 | VD-245 |

### MATERIAL AVAILABILITY AND PART NO.

| STD   | OPTIONS |   |     |     |
|-------|---------|---|-----|-----|
| FA    | HH      | R | MXS | GFA |
| FA118 | -       | - | -   | -   |

# FA119 82.6 x 21.8 x 7.1mm

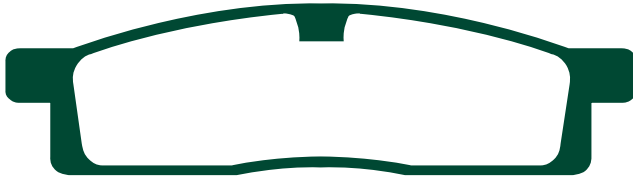

**Equivalents OE #**

|              |              |
|--------------|--------------|
| 1LR W0046 00 | 3UN W0045 00 |
| 2HF W0046 00 | 4ES W0045 00 |
| 2HF W0046 02 | 4P1 W0045 00 |

**Competitor X Ref**

|               |               |            |               |
|---------------|---------------|------------|---------------|
| <b>Dunlop</b> | <b>Ferodo</b> | <b>SBS</b> | <b>Vesrah</b> |
| DP408         | FDB453        | 589        | VD-244        |

**YAMAHA**

|   |       |   |
|---|-------|---|
| DT 50 LC  | 98-   | F |
| YZ 80 S/T/U/W/E/F/LWF/LWG/G/LWH/H/LWJ<br>/J/LWK/K/L/LWL/LWM/M/N/LWN | 86-01 | F |
| YZ 85 P/LWP/R/LWR/S/LWS/T/LWT/V/LWV<br>/LWW/W                       | 02-07 | F |
| TT-R 125 LWM/LWN/LWP/LWR/LWES/LWS<br>/LWET/LWT/LV/LEV/LEW           | 00-07 | F |

**MATERIAL AVAILABILITY AND PART NO.**

| STD     | OPTIONS |        |     |     |
|---------|---------|--------|-----|-----|
| FA      | HH      | R      | MXS | GFA |
| FA119TT | -       | FA119R | -   | -   |

# FA120 119.8 x 52 x 8mm

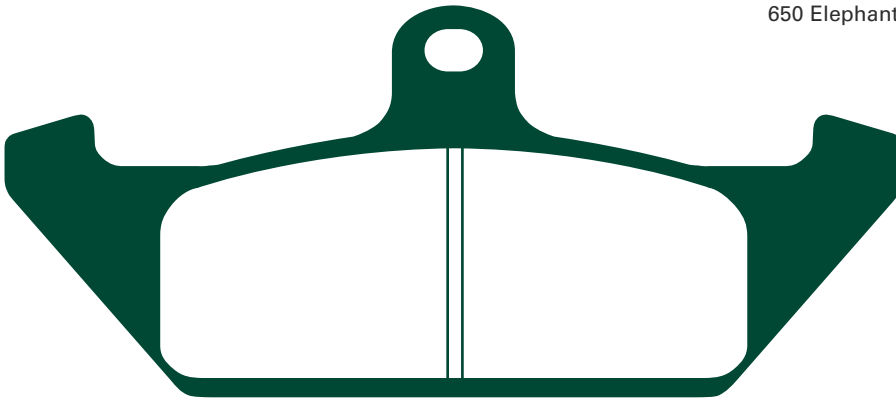

**CAGIVA**

|              |       |   |
|--------------|-------|---|
| Elefant 650  | 85    | F |
| 650 Elephant | 88-89 | F |

**Equivalents OE #**

8000 45453

**Competitor X Ref**

|               |               |            |               |
|---------------|---------------|------------|---------------|
| <b>Dunlop</b> | <b>Ferodo</b> | <b>SBS</b> | <b>Vesrah</b> |
| -             | FDB592        | 594        | VD-924        |

**MATERIAL AVAILABILITY AND PART NO.**

| STD   | OPTIONS |   |     |     |
|-------|---------|---|-----|-----|
| FA    | HH      | R | MXS | GFA |
| FA120 | -       | - | -   | -   |

# FA121 119.8 x 52 x 8mm

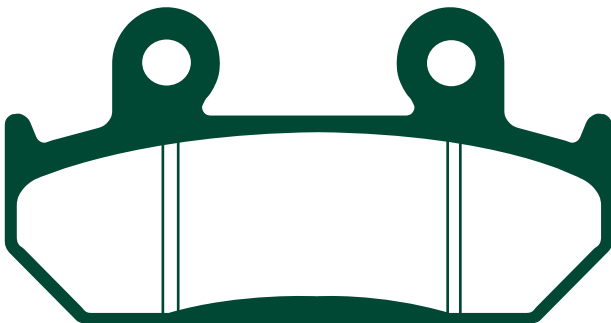

**HONDA**

|                               |       |   |
|-------------------------------|-------|---|
| CBR 250 FG/FGYA (MC14)        | 86    | F |
| CBR 250 RH (MC17)             | 87    | F |
| NSR 250 RG (MC16)             | 86    | F |
| CB 350 SG/SJ                  | 86-90 | F |
| CBR 400 RG (NC23)             | 86    | F |
| CBR 400 RHYA (NC23)           | 87    | F |
| CB 450 SG/SJ                  | 86-88 | F |
| CBR 500 FH/FJ/FK/FL           | 87-90 | F |
| CBR 600 FH/FJ/FK/FL           | 87-90 | F |
| VFR 400 ZG/ZH/RG/RG-YA (NC21) | 85-87 | F |
| VFR 400 RH2/RJ (NC24)         | 87-88 | F |
| XRV 750 L/M/N 'Africa Twin'   | 90-93 | F |

**SAME AS FA203 EXCEPT  
REDUCED THICKNESS**

**MATERIAL AVAILABILITY AND PART NO.**

| STD   | OPTIONS |   |     |     |
|-------|---------|---|-----|-----|
| FA    | HH      | R | MXS | GFA |
| FA121 | FA121HH | - | -   | -   |

**Equivalents OE #**

|               |               |               |
|---------------|---------------|---------------|
| 06455 ML4 P00 | 45105 ML4 000 | 45105 ML7 017 |
| 06455 ML7 P10 | 45105 ML4 004 | 45105 ML0 007 |
| 451A0 MN4 670 | 45105 ML4 006 | 45105 MN4 007 |
| 45105 KT7 751 | 45105 ML4 008 | 45105 MN4 008 |
| 45105 KT7 761 | 45105 ML4 014 |               |
| 45105 KT8 004 | 45105 ML4 024 |               |

**Competitor X Ref**

|               |               |            |               |
|---------------|---------------|------------|---------------|
| <b>Dunlop</b> | <b>Ferodo</b> | <b>SBS</b> | <b>Vesrah</b> |
| DP110         | FDB462        | 593        | VD-141/142    |

# FA122 55 x 52.6 x 9.4mm

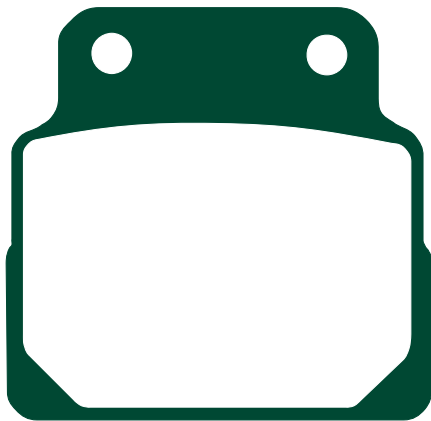

**HONDA**  
CB 450 DX-K

89-92 F&R

**Equivalents OE #**

43105 KK9 691

**Competitor X Ref**

| Dunlop | Ferodo | SBS | Vesrah |
|--------|--------|-----|--------|
| -      | -      | 598 | VD-146 |

| MATERIAL AVAILABILITY AND PART NO. |         |   |     |     |
|------------------------------------|---------|---|-----|-----|
| STD                                | OPTIONS |   |     |     |
| FA                                 | HH      | R | MXS | GFA |
| FA122                              | -       | - | -   | -   |

# FA123 74.8 x 54 x10mm

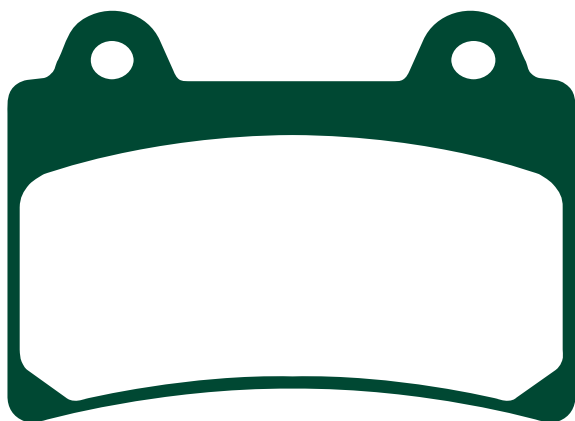

**YAMAHA**

|                            |       |     |
|----------------------------|-------|-----|
| FZR 250                    | 87    | F   |
| TZR 250 (2MA/2XW)          | 87-92 | F   |
| TDR 250                    | 88-92 | F   |
| TZR 250 (1KT/2AW)          | 87    | F   |
| FZR 400 (3EN1/3EN2)        | 88-89 | F   |
| FZR 400 RSP (2TK-EX-UP)    | 87    | F   |
| SRX 400 (3VN1/3VN2/3VN5)   | 90-96 | F   |
| SRX 600 (3SX)              | 90-91 | F   |
| FZ 750                     | 89-91 | F   |
| FZR 750 'Genesis'          | 87    | F   |
| TDM 850                    | 91-95 | F   |
| TRX 850                    | 96-99 | F   |
| FZR 1000 Genesis           | 87-88 | F   |
| FJ 1200 (3CV/3XW type)     | 88-95 | F   |
| FJ 1200 A (ABS model)      | 91-95 | F   |
| XJR 1200                   | 95-98 | F   |
| XVZ 13 AH/ATH "Royal Star" |       |     |
| Royal Star Classic         | 96-00 | F&R |
| XVZ 1300 TF Venture Star   | 99-01 | R   |
| XV 1600 Wildstar           | 99-04 | R   |

**Equivalents OE #**

|              |              |
|--------------|--------------|
| 1NL W0045 00 | 2GH W0045 01 |
| 1NL W0045 01 | 3EN W0045 00 |
| 1RK W0045 00 | 4KG W0045 00 |
| 1RK W0045 50 | 4NK W0046 00 |
| 1RK W0046 00 | 4NK W0045 00 |
| 2GH W0045 00 | 4WM W0046 00 |

**Competitor X Ref**

| Dunlop | Ferodo | SBS | Vesrah           |
|--------|--------|-----|------------------|
| DP409  | FDB662 | 590 | VD-242/<br>242/2 |

| MATERIAL AVAILABILITY AND PART NO. |         |   |     |     |
|------------------------------------|---------|---|-----|-----|
| STD                                | OPTIONS |   |     |     |
| FA                                 | HH      | R | MXS | GFA |
| FA123                              | FA123HH | - | -   | -   |

# FA124 87.9 x 41.1 x 8.8mm

# FA124/2 87.9 x 41.1 x 9.8mm

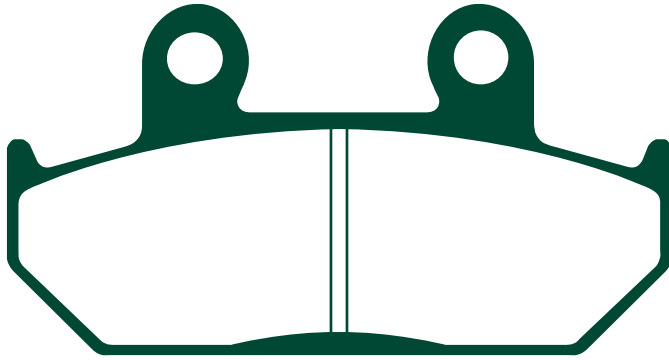

**Competitor X Ref**

| Dunlop    | Ferodo          | SBS | Vesrah           |
|-----------|-----------------|-----|------------------|
| DP109/116 | FDB452<br>R/663 | 600 | VD-143/<br>143/2 |

**Equivalents OE # - FA124**

|               |               |
|---------------|---------------|
| 45105 ML7 006 | 45105 NF4 000 |
| 45105 ML7 007 | 451A0 ML7 670 |
| 45105 MM5 007 | 45105 MM5 017 |
| 45105 MM5 008 | 06455 MM5 P00 |

**Equivalents OE # - FA124/2**

|               |               |               |
|---------------|---------------|---------------|
| 06455 MT8 405 | 45105 MN5 018 | 45105 MT8 008 |
| 06455 MS8 405 | 45105 MN9 008 | 45106 MW3 671 |
| 06455 MV4     | 45105 MR1 671 | 451A0 MT8 670 |
| 06455 MS8 405 | 45105 MS6 901 | 451A0 MT2 670 |
| 06455 MS6 P00 | 45105 MS8 008 | 8000 66796    |
| 45105 KV0 701 | 45105 MT2 007 |               |
| 45105 MN5 008 | 45105 MT2 008 |               |

**HONDA**

|                      |       |   |
|----------------------|-------|---|
| RS 125/250           | 88-89 | F |
| CBR 750 FH Superaero | 87-88 | F |
| VFR 750 FG/FH        | 86-87 | F |
| CBR 1000 FH/FJ       | 87-88 | F |

**FA124/2 - CAGIVA**

|               |       |   |
|---------------|-------|---|
| Canyon 500    | 96-00 | F |
| Canyon 600    | 96-99 | F |
| E 750 Elefant | 93-95 | F |
| E 900 Elefant | 90-92 | F |

**HONDA**

|   |       |   |
|---|-------|---|
| CD 250 UJ   | 88-92 | F |
| GB 250 J/L/P/S/V 'Clubman'                                | 89-97 | F |
| VTZ 250 H/J/K   | 86-88 | F |
| NV 400 C/J/CK 'Steed'                                     | 92-93 | F |
| NX 500 J/K/L/M/N/P/R/S/T Dominator                        | 92-96 | F |
| XL 600 VM/VN/VP Trans Alp                                 | 91-93 | F |
| VT 600 C/N "Shadow Custom"                                | 93    | F |
| NX 650 J/K/L/LII/M/N/P/R/S/T "Dominator"                  | 88-96 | F |
| XRV 650 J Africa Twin                                     | 88-89 | F |
| GL1500 J/K/SEM/SEN/SEP/SER/SES/SEV/SEW/SEX/SEY "Goldwing" | 88-00 | F |

**MATERIAL AVAILABILITY AND PART NO.**

| STD   | OPTIONS |   |     |     |
|-------|---------|---|-----|-----|
| FA    | HH      | R | MXS | GFA |
| FA124 | FA124HH | - | -   | -   |

**MATERIAL AVAILABILITY AND PART NO.**

| STD     | OPTIONS   |   |     |     |
|---------|-----------|---|-----|-----|
| FA      | HH        | R | MXS | GFA |
| FA124/2 | FA124/2HH | - | -   | -   |

# FA125 94.2 x 32 x 7.3mm



**1 Left/1Right**

**Competitor X Ref**

| Dunlop | Ferodo | SBS | Vesrah |
|--------|--------|-----|--------|
| DP814  | FDB495 | 603 | VD-139 |

**Equivalents OE #**

|                |                |
|----------------|----------------|
| 45105 HA5 671A | 45106 HA5 671B |
| 45105 HA5 672A | 45106 HA5 672B |
| 45105 HA5 672B | 45106 KS6 701A |
| 45105 KS6 831A | 45106 KS6 701B |
| 45105 KT0 405  | 45106 KS6 831B |
| 45105 KZ1 405  | 45106 KY7 008  |
| 45105 KW3 405  | 45106 KW3 681  |
| 45105 KW3 681  | 451A0 HB9 670  |
| 45105 KY7 008  |                |

**HONDA**

|  |       |   |
|--|-------|---|
| CRM 50 RN/RP/RR/RT                         | 93-96 | F |
| CRM 75 RK/RL/RM/RP/RR                      | 89-94 | F |
| CR 125 RH/RJ/RK/RL/RM/RN/RP/RR             | 87-94 | F |
| AX-1 (NX 250 J/K/R/R3)                     | 89-94 | F |
| CR 250 RH/RJ/RK/RL/RM/RN/RP/RR             | 87-94 | F |
| CRM 250 R (RK) MK1/MD24 (100001-1008385)   | 89-90 | F |
| CRM 250 R (RM) MK2/MD24 (1200001-1211634)  | 91-92 | F |
| CRM 250 R (RP-RP-11) MK2/2 MD24 (1300001-) | 93    | F |
| NX 250 J/K/L/ZL/M/P/2P                     | 87-93 | F |
| TRX 250 RG/RH/RJ/RK                        | 86-89 | F |
| XL 250 RL                                  | 90    | F |
| XR 250 RJ/RK/RL/RM/RN/RP/RR/RS             | 88-95 | F |
| CR 500 RH/RJ/RK/RL/RM/RN/RP/RR             | 87-94 | F |
| XR 600 RJ/RK/RL/RM                         | 88-91 | F |

**ALSO SEE FA185 FOR OVERSIZE PAD**

**MATERIAL AVAILABILITY AND PART NO.**

| STD     | OPTIONS |        |        |     |
|---------|---------|--------|--------|-----|
| FA      | HH      | R      | MXS    | GFA |
| FA125TT | -       | FA125R | MXS125 | -   |



# FA126 67.5 x 51 x 7mm

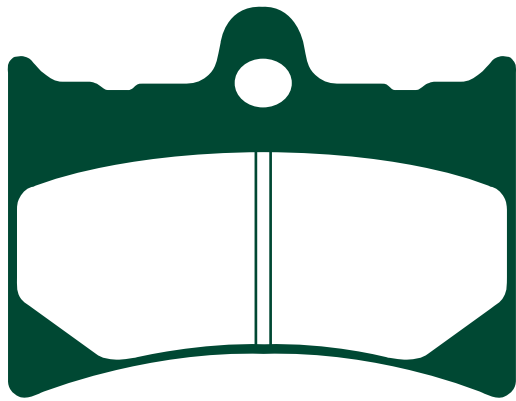

## ALFER

|               |     |   |
|---------------|-----|---|
| 125 MC        | 88- | F |
| 250 MC        | 88- | F |
| 250 GR/Enduro | 88- | F |
| 300 GR/Enduro | 88- | F |

## APRILIA

|                   |       |   |
|-------------------|-------|---|
| AF-1 125          | 88-91 | F |
| RS 125 All models | 92-05 | F |
| Tuono 125         | 03-04 | F |

## BENELLI

|           |     |   |
|-----------|-----|---|
| Devil 50  | 92- | F |
| Spring 50 | 93- | F |
| Devil 80  | 92- | F |
| Tarno 125 | 89- | F |

## GILERA

|                 |       |   |
|-----------------|-------|---|
| GFR 125         | 94    | F |
| Nordwest        | 94-96 | F |
| 125 CX          | 91-   | F |
| 125 MX1/MXR     | 89-   | F |
| 125 SP 01/SP 02 | 89-   | F |
| Nord-West 350   | 94-   | F |

## KTM

|             |    |     |
|-------------|----|-----|
| Most Models | 87 | F&R |
|-------------|----|-----|

## MALAGUTI

|             |    |   |
|-------------|----|---|
| Madison 125 | 99 | R |
|-------------|----|---|

## MOTO GUZZI

|             |       |   |
|-------------|-------|---|
| Quota 100 D | 93-95 | F |
|-------------|-------|---|

## MZ

|                  |       |   |
|------------------|-------|---|
| Skorpion replica | 95-96 | F |
|------------------|-------|---|

### Equivalents OE #

|              |             |
|--------------|-------------|
| 8113489      | 90214 01000 |
| 000306546310 |             |

### Competitor X Ref

| MATERIAL AVAILABILITY AND PART NO. |         |         |        |     |     |
|------------------------------------|---------|---------|--------|-----|-----|
| STD                                | OPTIONS |         |        |     |     |
| FA                                 | TT      | HH      | R      | MXS | GFA |
| FA126                              | FA126TT | FA126HH | FA126R | -   | -   |

| Dunlop | Ferodo | SBS | Vesrah |
|--------|--------|-----|--------|
| DP604  | FDB498 | 591 | VD-943 |

# FA128 A. 35 x 85 x 8mm B. 37 x 55.5 x 9.8mm

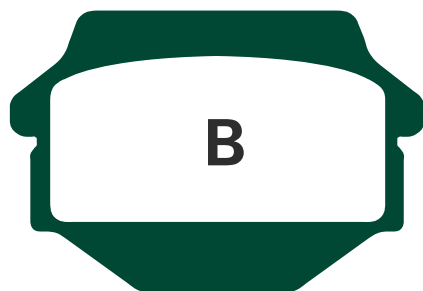
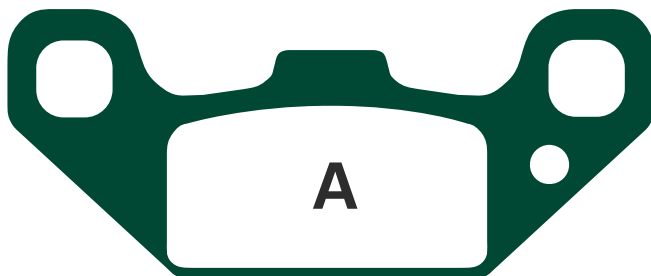

## KAWASAKI

|                            |       |   |
|----------------------------|-------|---|
| KXF 250 A1/A2 Tecate 4     | 87-88 | F |
| KSF 250 A8-A18             | 94-04 | F |
| KEF 300 B1/B2 Lakota Sport | 01-02 | F |

## SUZUKI

|                    |       |   |
|--------------------|-------|---|
| LT 250 RH/RJ/RK/RL | 87-90 | F |
| LT 500 RL          | 90    | F |

### Equivalents OE #

|             |             |
|-------------|-------------|
| 43082 1067  | 59300 03840 |
| 59100 43810 |             |

### Competitor X Ref

| Dunlop | Ferodo  | SBS | Vesrah |
|--------|---------|-----|--------|
| DP821  | FDB2013 | 591 | VD332  |

| MATERIAL AVAILABILITY AND PART NO. |         |        |     |     |
|------------------------------------|---------|--------|-----|-----|
| STD                                | OPTIONS |        |     |     |
| FA                                 | HH      | R      | MXS | GFA |
| FA128TT                            | -       | FA128R | -   | -   |

# FA129 A. 141 x 41.5 x 9.7mm B. 95 x 34.5 x 9.7mm

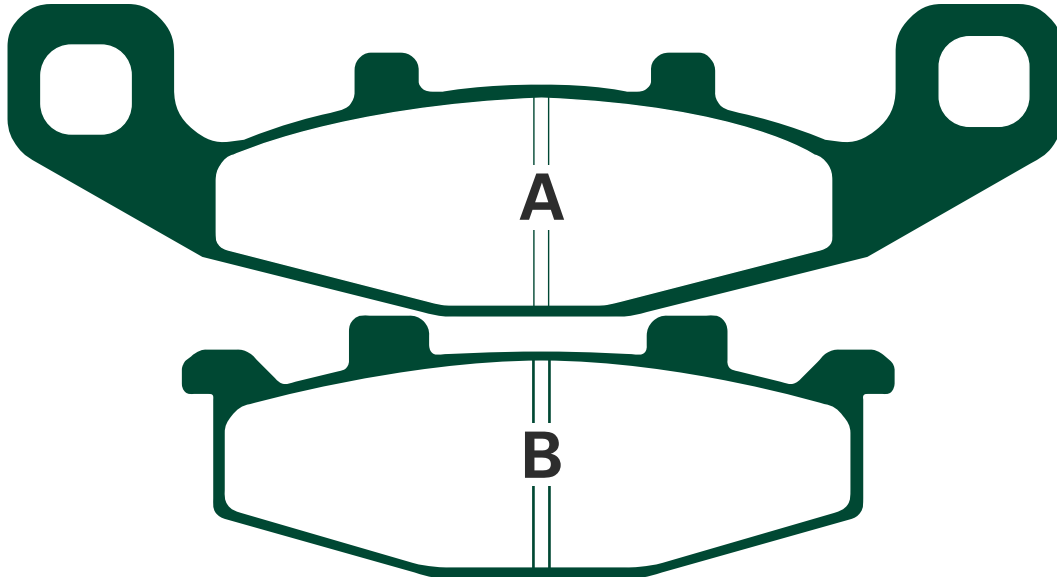

### HYOSUNG

Comet 250/600 02 F

### KAWASAKI

|                                |          |     |
|--------------------------------|----------|-----|
| GPX 250 R (ZX 250 F2-F9)       | 88-95    | F   |
| GPX 250 R (EX 250 F)           | 87       | F   |
| KLE 250 A2 (Anhelo)            | 95       | F   |
| KLE 250 A3/A5/A6               | 97/00-01 | F   |
| ZZR 250 (EX 250 H1-H13)        | 90-03    | F   |
| ZR 250 A1-A5                   | 91-95    | F   |
| GPX 400 R (ZX 400 F1)          | 87       | R   |
| GPZ 400 R 'D4'                 | 88       | R   |
| ZRX 400 (ZR 400 E1/E2)         | 94-95    | F   |
| ZZR 400 (ZX 400 K1/K2/K3)      | 90-92    | R   |
| ER-5 (ER500 A1/A2/A3/A4)       | 97-00    | F   |
| GPz 500 S (EX 500 A1-A6/D1-D7) | 87-01    | F   |
| KLE 500 A1-A12                 | 91-04    | F   |
| KLE 500 B1/B1P/B6F             | 05-06    | F   |
| ZR 550 B2-B6 "Zephyr"          | 91-99    | F   |
| GPx 600 R (ZX 600 C1-C7)       | 88-96    | F&R |
| ZL 600 B1 "Eliminator"         | 95-97    | F   |
| ZZ-R 600 (ZX 600 D1-D3)        | 90-93    | R   |
| KL 650 B1-B3 "Tengai"          | 89-92    | F   |
| GPX 750 R (ZX 750 F1-F3)       | 87-89    | F&R |

### KAWASAKI CONTD.

|                             |       |     |
|-----------------------------|-------|-----|
| ZR 750 C1-C5 'Zephyr'       | 92-95 | F&R |
| ZR 750 D1 'Zephyr'          | 96-   | R   |
| GPz 900R A7-A8              | 90-96 | R   |
| GPZ 900 R (ZX 900 A11)      | 98    | R   |
| GPZ 900 R (ZX 900 A12-15)   | 99-02 | R   |
| ZX 100 B1-B3 (ZX-10)        | 88-90 | F&R |
| ZG 1000 A9-A18 (1000 GTR)   | 94-03 | F   |
| ZZR 1100 (ZX 1100 C1-C3)    | 90-92 | R   |
| ZR 1100 A1-A4 'Zephyr'      | 92-95 | R   |
| ZR 1100 B1 'Zephyr'         | 96-97 | R   |
| ZR 1100 B5 (Zephyr 1100 RS) | 02    | R   |

### SUZUKI

|                             |       |   |
|-----------------------------|-------|---|
| RG 125 UN 'Wolf'            | 92-94 | F |
| GSF 250 N/ZM/P/NP/ZP/N/NR   | 92-96 | F |
| GSX 250 SSM Katana (GJ76A)  | 91    | F |
| SW-1 250 (NJ45A)            | 92    | F |
| GSF 400 M/N/P Bandit        | 91-95 | F |
| GS 500 EK/EL/EM/EN/EP/ER/ES | 89-95 | F |
| DR 800 SM                   | 91    | F |
| VX 800 L/M/N/P/R            | 90-96 | F |
| GSX 1100 GM/GN              | 91-94 | F |

### Competitor X Ref

| Dunlop | Ferodo   | SBS | Vesrah |
|--------|----------|-----|--------|
| DP314  | FDB481/R | 597 | VD-427 |

### Equivalents OE #

|            |            |             |             |
|------------|------------|-------------|-------------|
| 43082 1068 | 43082 1095 | 43082 1134  | 59100 26810 |
| 43082 1069 | 43082 1104 | 43082 1139  | 59100 45860 |
| 43082 1074 | 43082 1114 | 43082 1161  | 59301 45860 |
| 43082 1077 | 43082 1123 | 43082 1189  | 59302 45810 |
| 43082 1088 | 43082 1124 | 59100 01820 |             |

### MATERIAL AVAILABILITY AND PART NO.

| STD   | OPTIONS |        |     |     |
|-------|---------|--------|-----|-----|
| FA    | HH      | R      | MXS | GFA |
| FA129 | FA129HH | FA129R | -   | -   |

# FA130 A. 73.3 x 49.3 x 7mm B. 60.8 x 62.8 x 9mm

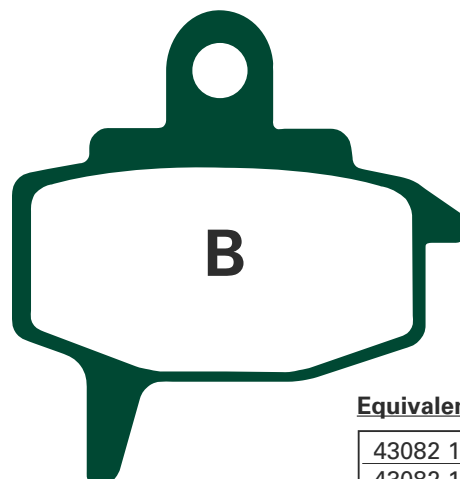

### KAWASAKI

|               |       |   |
|---------------|-------|---|
| KX 125 E2/F1  | 87-88 | F |
| KX 250 E1/F1  | 87-88 | F |
| KX 500 C1/D1  | 87-88 | F |
| KLR 650 A1-A3 | 87-89 | F |

### Competitor X Ref

| Dunlop | Ferodo | SBS | Vesrah |
|--------|--------|-----|--------|
| DP313  | FDB494 | 602 | VD-126 |

### Equivalents OE #

|            |
|------------|
| 43082 1072 |
| 43082 1078 |

### MATERIAL AVAILABILITY AND PART NO.

| STD   | OPTIONS |        |     |     |
|-------|---------|--------|-----|-----|
| FA    | HH      | R      | MXS | GFA |
| FA130 | -       | FA130R | -   | -   |

**FA131 75 x 36 x 10.5mm**

**\*FA131R/MXS 75 x 36 x 9.5mm**

**FA131/2 75 x 36 x 7.5mm**

**FA131/3 75 x 36 x 9.5mm**

\* This pad is made to a thinner dimension to allow fitting of radiator shims to the back of pads if required.



**1 Left/1Right**

**Equivalents OE # - FA131**

|                |                |              |
|----------------|----------------|--------------|
| 06435 KCZ 000  | 43106 KS6 702B | 43082 1267   |
| 06455 6CK 006  | 43082 1173     | 5MV W0046 00 |
| 43082 1228     | 5DH WD0046 00  | 43082 5010   |
| 43105 GT4 004A | 5ET W0046 00   | 43082 5012   |
| 43105 GW2 004A | 5GR W0046 00   | 43082 1292   |
| 43105 KS6 701A | 69100 36820    | 69100 37810  |
| 43105 KS6 702A | 69100 36830    | BE2500 22068 |
| 43105 KZ1 405  | 69100 36840    | 69400 37820  |
| 43106 GT4 004B | 69100 36850    | 69100 37830  |
| 43106 GW2 004B | 69100 36860    | 69095        |
| 43106 KS6 701B | 69100 36870    | 69096        |

**Equivalents OE # - FA131/2**

|        |        |
|--------|--------|
| 752394 | 752391 |
| 752071 |        |

**Equivalents OE # - FA131/3**

|               |               |
|---------------|---------------|
| 06435 GT4 405 | 06431 GW2 405 |
|---------------|---------------|

**Competitor X Ref**

| Dunlop    | Ferodo | SBS | Vesrah |
|-----------|--------|-----|--------|
| DP815/621 | FDB539 | 604 | VD-144 |

| MATERIAL AVAILABILITY AND PART NO. |         |        |        |          |
|------------------------------------|---------|--------|--------|----------|
| STD                                | OPTIONS |        |        |          |
| FA                                 | HH      | R      | MXS    | GFA      |
| FA131                              | -       | FA131R | MXS131 | GFA131HH |

| MATERIAL AVAILABILITY AND PART NO. |         |   |     |     |
|------------------------------------|---------|---|-----|-----|
| STD                                | OPTIONS |   |     |     |
| FA                                 | HH      | R | MXS | GFA |
| FA131/2                            | -       | - | -   | -   |

| MATERIAL AVAILABILITY AND PART NO. |         |   |     |     |
|------------------------------------|---------|---|-----|-----|
| STD                                | OPTIONS |   |     |     |
| FA                                 | HH      | R | MXS | GFA |
| FA131/3                            | -       | - | -   | -   |

|  |  |       |   |  |
|--|--|-------|---|--|
| <b>BETA</b>                              |  |       |   |  |
| Alp 125.200                              |  | 05-07 | R |  |
| Alp 4.0                                  |  | 05-07 | R |  |
| <b>CPI</b>                               |  |       |   |  |
| Sauel 125                                |  |       | R |  |
| <b>GAS-GAS</b>                           |  |       |   |  |
| EC 125/200/250/300                       |  | 00-07 | R |  |
| Enduro EC 200/250/300                    |  | 99-00 | R |  |
| MC 125                                   |  | 05    | R |  |
| MX 125/250                               |  | 01-04 | R |  |
| Pampera 125/450                          |  | 05-07 | R |  |
| MX 200/250/300                           |  | 99-00 | R |  |
| SM 125/250/400 FSE                       |  | 02    | R |  |
| SM 125/250 (2T)                          |  | 01-06 | R |  |
| Pampera 400                              |  | 06    | R |  |
| SM 400 FSE (2T)                          |  | 01-02 | R |  |
| FSE 450/500                              |  | 05-06 | R |  |
| FSR 450 (4T)                             |  | 07    | R |  |
| SM 450                                   |  | 03-06 | R |  |
| <b>HONDA</b>                             |  |       |   |  |
| CB 50 V/W Dream 50                       |  | 97-98 | R |  |
| NSR 50 RV/RW/RX/RV                       |  | 97-00 | R |  |
| XR 50 M5 (AD14) Motard                   |  | 05    | R |  |
| CR 80 RN/RP/RR/RS/RT/RBT/RV/RBV/RW/      |  |       |   |  |
| RBW/RX/RB/RV/RBY/R1/RB1/R2/RB2           |  | 92-02 | R |  |
| NSR 80 J-2/K/L/N/P/R/S (HC06)            |  | 88-   | R |  |
| CR 85 R3/RB3/R4/RB4/R5/RB5/R6/RB6/R7/RB7 |  | 03-07 | R |  |

|  |  |       |   |  |
|--|--|-------|---|--|
| <b>HONDA Contd.</b>                                |  |       |   |  |
| NH 90 M/P/R Yuppy                                  |  | 95-97 | F |  |
| XR 100 MS (HD13) Motard                            |  | 05    | R |  |
| CR 125/250/500 RH/RJ/RK/RL/                        |  |       |   |  |
| RM/RN/RP/RR/RS/RT/RV/RW/RX/RV/R1                   |  | 87-01 | R |  |
| SL 230 'Free Landports' (MD33) V/W/X/1             |  | 97-01 | R |  |
| CRM 250 R (RM) MK2/MD24 (120001-1211634)           |  | 91-92 | R |  |
| CRM 250 R (RP-RP-11) MK2/2 (MD 24 1300001-)        |  | 93    | R |  |
| CRM 250 'Active Radial' (MD32) ARV/ARW             |  | 97-98 | R |  |
| XL 250 RL  |  | 90    | R |  |
| XLR 250 RM/R3N/RP/RR/R3R (MD22)                    |  | 91-   | R |  |
| XR 250 RL/RM/RN/RP/RR/RS                           |  | 90-95 | R |  |
| XR 250 RT/RV/RW/RX/RV/R1/R2/R3/R4                  |  | 96-04 | R |  |
| XR 250 Y/3 (MD30)                                  |  | 00-03 | R |  |
| XR 250 3/5 (MD30) Motard                           |  | 03-05 | R |  |
| XR 250 Ill Y/3 Baja                                |  | 00-03 | R |  |
| NX4 Falcon   |  | 02-05 | R |  |
| XR 400 RT/RV/RW/RX/RV/R1-R5                        |  | 96-05 | R |  |
| XR 400 R5/R6 (NC38E) Motard                        |  | 05-06 | R |  |
| XR 600 RM/RP/RR/RS/RT/RV/RW/RX/RV                  |  | 91-00 | R |  |
| XR 650 RY/R1-R6                                    |  | 00-06 | R |  |
| <b>HONDA DALL'ARA</b>                              |  |       |   |  |
| XR 250 R   |  | 04    | R |  |
| XR 650 R   |  | 04    | R |  |
| <b>HONDA HM (Italy)</b>                            |  |       |   |  |
| CR 85 R/R2   |  | 03-07 | R |  |
| <b>HYOSUNG</b>                                     |  |       |   |  |
| RX 400   |  | 05    | R |  |
| <b>HUSQVARNA</b>                                   |  |       |   |  |
| WXE 125  |  | 07    | R |  |
| <b>KAWASAKI</b>                                    |  |       |   |  |
| KX 125 K2-K5/L1/L2/L3/L4/M1/M2/M3/M6F              |  | 95-06 | R |  |
| KLX 250 J1-J6 D-Tracker                            |  | 98-03 | R |  |
| KX 250 K2-K5/L1/L2/L3/L4/M1/M2/R1/R6F/R7F          |  | 95-07 | R |  |
| KLX 300 A2/A3/A4/A5/A6/A7/A8/A9/A10/A6F/A7F        |  | 97-07 | R |  |
| KLX 400 R (KLX 400 B1/B2)                          |  | 03-04 | R |  |
| KX 500 E8-A16                                      |  | 96-04 | R |  |
| <b>SUZUKI</b>                                      |  |       |   |  |
| RM 125 T/V/W/X/Y/K1/K2/K3/K4/K5/K6/K7              |  | 96-07 | R |  |
| RM 250 T/V/W/X/Y/K1/K2/K3/K4/K5/K6/K7              |  | 96-07 | R |  |
| RMX 250 ST/SV/SW/SX (SJ14A)                        |  | 96-99 | R |  |
| 250 SBK2 (LX 250 L)                                |  | 02    | R |  |
| DR-Z 400 SEY/EY/Y/SEK1/EK1/K2/SEK2/EK2/K3/SEK3/EK3 |  |       |   |  |
| /K4/SEK4/EK4/EK5/SK5/SK6/SK7/K7/EK7/K6             |  | 00-07 | R |  |
| DR-Z 400 SMK5/SMK6/SMK7                            |  | 05-07 | R |  |
| <b>TM</b>  |  |       |   |  |
| Junior 80/85/100                                   |  | 05-07 | R |  |
| Cross MX 125 (2T)                                  |  | 01-07 | R |  |
| Enduro EN 125 (2T)                                 |  | 01-07 | R |  |
| SMR 125  |  | 05    | R |  |
| Cross MX 250 (2T)                                  |  | 01-07 | R |  |
| Enduro EN 250 (2T)                                 |  | 01-07 | R |  |
| EN 250 F (4T) Enduro                               |  | 04-07 | R |  |
| SM 250   |  | 02    | R |  |
| SME 250 (4T)                                       |  | 04-   | R |  |
| 250 (4T) Cross                                     |  | 02-07 | R |  |
| Cross MX 300 (2T)                                  |  | 01-07 | R |  |
| Enduro EN 300 (2T)                                 |  | 01-07 | R |  |
| 400 (4T) MX Cross                                  |  | 02-03 | R |  |
| SM 400   |  | 02-03 | R |  |
| SME 400 (4T)                                       |  | 04    | R |  |
| EN 450 F (4T)                                      |  | 04-07 | R |  |
| MX 450 F (4T)                                      |  | 04-07 | R |  |
| SMR 450 FES  |  | 05-07 | R |  |
| SMX 450 F  |  | 05-07 | R |  |
| 530 (4T) Cross                                     |  | 02-03 | R |  |
| EN 530 F (4T)                                      |  | 04-07 | R |  |
| SM 530   |  | 02-03 | R |  |
| SME 530 (4T)                                       |  | 04    | R |  |
| SMR 530 FES  |  | 05-07 | R |  |
| SMX 530 F  |  | 05-07 | R |  |
| SMX 660 F  |  | 04-07 | R |  |
| <b>YAMAHA</b>                                      |  |       |   |  |
| YZ 125 K/L/M/N/P                                   |  | 98-02 | R |  |
| YZ 250 K/L/M/N/FN/P/FP                             |  | 98-02 | R |  |
| WR 250 ZK  |  | 98    | R |  |
| WR 250 FN/FP                                       |  | 01-02 | R |  |
| YZ 400 FL/WR 400 FL/FM/FN                          |  | 99-01 | R |  |
| YZ 426 FM/FN/FP                                    |  | 00-02 | R |  |
| WR 426 FN/FP                                       |  | 01-02 | R |  |
| <b>FA131/2</b>                                     |  |       |   |  |
| <b>PEUGEOT</b>                                     |  |       |   |  |
| SV 50 Geo 80/125                                   |  | 91-92 | F |  |
| <b>SYM (SANYANG)</b>                               |  |       |   |  |
| SR 100 Sunrise                                     |  | 97-   | F |  |
| <b>HONDA</b>                                       |  |       |   |  |
| NS-1 75  |  | 92-   | R |  |
| <b>FA131/3</b>                                     |  |       |   |  |
| <b>HONDA</b>                                       |  |       |   |  |
| SRX 50 T/W/X 'Joker/Shadow'                        |  | 97-99 | F |  |
| NSR 75 N/P/R/X/Y (NS-1/NSR 80)                     |  | 92-00 | R |  |
| Lead 90  |  | 88-   | F |  |
| NH 90 M/P/R  |  | 91-94 | F |  |
| SRX 90 T/W/X 'Shadow'                              |  | 97-99 | F |  |
| <b>KYMCO</b>                                       |  |       |   |  |
| Super 9 50   |  | 99-01 | F |  |
| <b>PEUGEOT</b>                                     |  |       |   |  |
| SV 50 Geo 80/125                                   |  | 93-   | F |  |

# FA132 79.6 x 46.5 x 9mm

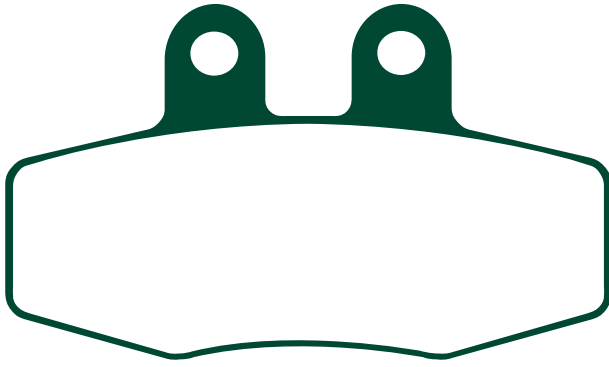

**Competitor X Ref**

|               |               |            |               |
|---------------|---------------|------------|---------------|
| <b>Dunlop</b> | <b>Ferodo</b> | <b>SBS</b> | <b>Vesrah</b> |
| DP606         | FDB561        | 621        | VD-936        |

| MATERIAL AVAILABILITY AND PART NO. |         |        |     |     |
|------------------------------------|---------|--------|-----|-----|
| STD                                | OPTIONS |        |     |     |
| FA                                 | HH      | R      | MXS | GFA |
| FA132                              | -       | FA132R | -   | -   |

**Equivalents OE #**

|              |
|--------------|
| 565 13209544 |
| 565 13209323 |

**KTM**

|                           |       |     |
|---------------------------|-------|-----|
| Most 1988 Models          | 88    | F&R |
| Enduro Models             | 89-91 | F&R |
| 250/300 E/XC/GS           | 90-91 | F   |
| 125/350 E/XL/GS           | 90-91 | F&R |
| 125/250/300/600 Enduro    | 92-93 | F   |
| 125/250/400/600 LC Models | 89-91 | F&R |
| MX 125                    | 89-91 | F&R |
| MX 125                    | 92-93 | F   |
| EXC 125                   | 89    | F&R |
| D-XC/E-XC/E-GS 125        | 90-91 | F&R |
| D-XC/E-XC/E-GS 125        | 92-93 | F   |
| MX 250                    | 88-91 | F&R |
| EXC/EGS 250               | 88-89 | F&R |
| DXC/EXC 5-0               | 90    | F&R |
| D-XC/EXC/E-GS 250         | 91    | F&R |
| D-XC/E-XC/T-XC/E-GS 250   | 92-93 | F   |
| MX/EXC/EGS 350            | 88    | F&R |
| MX 350                    | 89-91 | F&R |
| DXC/EXC/EGS 350           | 90-91 | F&R |
| EXC 350                   | 89    | F&R |
| LC-4 MX/EXC 500           | 89-91 | F&R |
| LC-4 MX/EXC 600           | 89-91 | F&R |
| LC-4 EXC 600              | 92-93 | F   |

**MAICO**

|            |       |     |
|------------|-------|-----|
| All Models | 89-93 | F&R |
| 250 MX     | 94-98 | F&R |
| 500 MX     | 94-98 | F   |

**OSSA**

|     |    |   |
|-----|----|---|
| 500 | 92 | F |
|-----|----|---|

**PHB**

|     |    |   |
|-----|----|---|
| 500 | 92 | F |
|-----|----|---|

# FA134 99.8 x 46.7 x 8.5mm

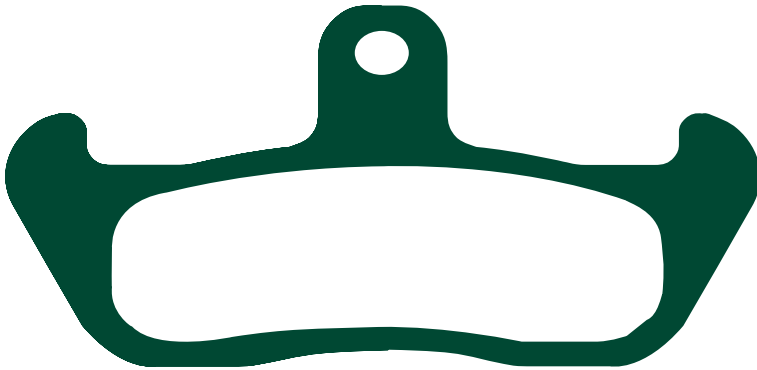

**NOTE**

EBC pads are supplied with close tolerance slider pin holes and do not therefore require use of original anti-rattle clip slider pin hole.

**Competitor X Ref**

|               |               |            |                |
|---------------|---------------|------------|----------------|
| <b>Dunlop</b> | <b>Ferodo</b> | <b>SBS</b> | <b>Vesrah</b>  |
| DP605         | FDB499        | 608        | VD-929/<br>942 |

**Equivalents OE #**

|              |
|--------------|
| 341878       |
| 2VW F0047 00 |
| K00946315    |

| MATERIAL AVAILABILITY AND PART NO. |         |        |     |     |
|------------------------------------|---------|--------|-----|-----|
| STD                                | OPTIONS |        |     |     |
| FA                                 | HH      | R      | MXS | GFA |
| FA134                              | -       | FA134R | -   | -   |

**APRILIA**

|         |    |   |
|---------|----|---|
| AF1 125 | 87 | F |
|---------|----|---|

**CAGIVA**

|                   |       |   |
|-------------------|-------|---|
| WMX 125           | 89    | F |
| Excaliber 501 RLX | 92    | F |
| WMX 250           | 86-89 | F |
| WM 125            | 87-88 | F |
| 750 Elefant       | 90-92 | F |

**GILERA**

|            |       |   |
|------------|-------|---|
| 125 Apache | 91-   | F |
| RC 600     | 89-90 | F |

**HONDA HM (Italy)**

|  |       |   |
|--|-------|---|
| CRE 50 Six/Baja/Derapage Brembo caliper/Kayaba forks | 95-02 | F |
|--|-------|---|

**HUSQVARNA**

|               |             |   |
|---------------|-------------|---|
| CR 125        | 91          | F |
| WR 125        | 87-88/91    | F |
| CR 240        | 87-88       | F |
| WR 240        | 87-88/90-91 | F |
| CR 250        | 87-88/91    | F |
| WR 250        | 87-88/90-91 | F |
| XC 250        | 87-88       | F |
| WR 260        | 90-91       | F |
| TE 350        | 90-91       | F |
| WR 400        | 87-88       | F |
| CR 430        | 87-88       | F |
| WR 430        | 87-88       | F |
| XC 430        | 87-88       | F |
| 430 Automatic | 87-88       | F |
| CR 500        | 87-88       | F |
| XC 500        | 87-88       | F |
| TC 510        | 89-90       | F |
| TE 510        | 89-90       | F |
| WMX 510       | 89          | F |
| WXE 510       | 89          | F |
| TC 610        | 91          | F |
| TE 610        | 91          | F |

**KRAM-IT (KRAMER)**

|                    |     |   |
|--------------------|-----|---|
| ER 125/250/300 RV3 | 88- | F |
| ER 500/600         | 96- | F |

**MOTO MORINI**

|                       |     |   |
|-----------------------|-----|---|
| Excaliber 350/501 RLX | 93- | F |
| Dart 350              | 87  | F |

**YAMAHA**

|                    |       |   |
|--------------------|-------|---|
| TDR 125 (3SH/3XD1) | 89-93 | F |
|--------------------|-------|---|

# FA135 A. 96.7 x 42.7 x 7.4mm B. 77 x 42.2 x 7.4mm

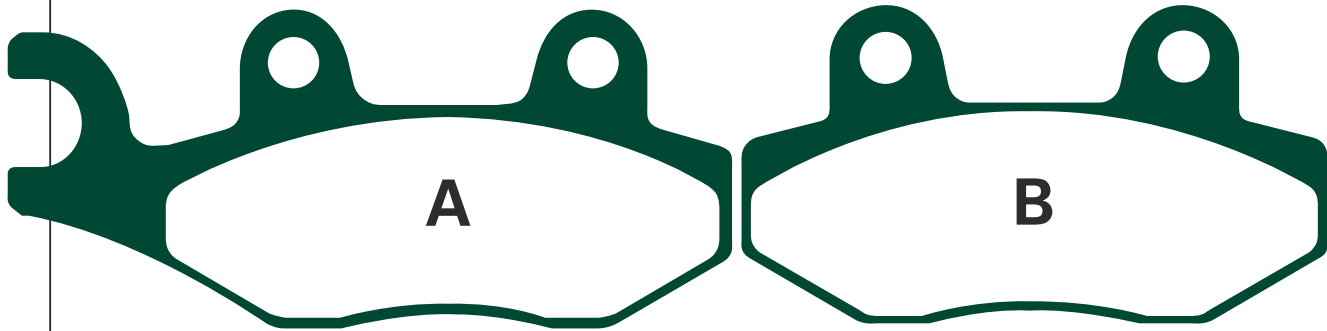

## BAROSSA QUADS

|                   |       |   |
|-------------------|-------|---|
| 170 Sport         | 03-04 | R |
| 170 Cheetah/Magna | 03-05 | R |
| Quarterback 250   | 05    | R |

## ECO

|                         |  |   |
|-------------------------|--|---|
| Bushman 150 (LX 150 GY) |  | F |
|-------------------------|--|---|

## GAS GAS

|                |    |         |
|----------------|----|---------|
| KZ 250 RV Quad | 06 | F(left) |
|----------------|----|---------|

## HUSQVARNA

|        |       |   |
|--------|-------|---|
| CR 125 | 92-94 | F |
| WR 125 | 93-94 | F |
| CR 250 | 92-94 | F |
| WR 250 | 92-94 | F |
| TE 350 | 92-94 | F |
| CR 360 | 92-94 | F |
| WR 360 | 92-94 | F |
| TE 610 | 92-94 | F |
| TC 610 | 92-94 | F |

## KAWASAKI

|                                     |       |         |
|-------------------------------------|-------|---------|
| KX125 G1/H1/H2/J1/J2                | 89-93 | F       |
| KDX 200 E5/E6                       | 93-94 | F       |
| KDX 200 SR (DX200G)                 |       | F       |
| KX 250 G1/H1/H2/J1/J2               | 89-93 | F       |
| KDX 250 SR (KDX 250 F1)             | 91    | F       |
| KDX 250 D1                          | 91-93 | F       |
| KLF 300 C1-C17 "Bayou"              | 89-05 | F(left) |
| KLF 400 B1-B7 Bayou                 | 93-99 | F(left) |
| KX 500 E1-E5                        | 89-93 | F       |
| KVF 750 A1/B1/A2/B2 Brute Force 4x4 | 05-06 | F(left) |

## MOTO ROMA

|                 |       |   |
|-----------------|-------|---|
| Road Runner 125 | 04-05 | F |
|-----------------|-------|---|

## QUADZILLA

|                      |       |   |
|----------------------|-------|---|
| Stingr R170E         | 06    | R |
| ST 200 E (Automatic) | 06    | R |
| WK 300               | 06-07 | F |

## SUZUKI

|                                    |       |         |
|------------------------------------|-------|---------|
| EN 125-2/125-2A                    | 05    | F       |
| TS 125 RK/RL/RM/RN/RP/RR           | 90-96 | F       |
| RM 125/250 H/J/K/L/M/N/P/R/S       | 87-95 | F       |
| TS 200 RK/RL/RM/RN/RP/RR           | 89-94 | F       |
| DR 250 SL/SM/SN/SEP/SER/SES        | 90-95 | F       |
| RMX 250 K/M/N/P/R/S                | 89-95 | F       |
| RMX 250 SN/SR/SS (SJ13A)           | 95-97 | F       |
| DR 350 SL/SM/SN/SP/SER/SES/SET/SEV | 91-97 | F       |
| LT-F 300 FK2                       | 02    | F(left) |
| LT-R 450 K6/K7                     | 06-07 | F(left) |
| LT-A 500 FY/FK1                    | 00-01 | F(left) |
| LT-F 500 FW/FX/FY/FK1/FK2          | 98-02 | F(left) |

## YAMAHA

|                                      |       |         |
|--------------------------------------|-------|---------|
| YZ 125 W/A/B/D/E/F/G/H/J             | 89-97 | F       |
| DT 200 WR (3XP)                      | 92-93 | F       |
| WR 200 D/E/F                         | 92-94 | F       |
| DT 230 (4TP1/2) Lanza                | 91-98 | F       |
| TT 250 R (4GY) Raid/4MR2             | 96    | F       |
| TT 250 R RL/RM/RN/RP/RR/RS           | 99-04 | F       |
| WR 250 ZB/ZD/ZE/ZF/ZG/ZH/ZJ          | 91-97 | F       |
| YZ 250 D/E/F/G/H/J                   | 92-97 | F       |
| YZ 250 W/WRW                         | 89    | F       |
| YZ 250 A/WRA/B                       | 90-91 | F       |
| YZ 250 A/WRA/B                       | 90-91 | F       |
| YFZ 450 S/T/V/W                      | 04-07 | F(left) |
| YFM 450 FXV Wolverine                | 06    | F(left) |
| WR 500 ZD                            | 92    | F       |
| YXR 66 FAS/FAT Rhino 4x4 Side x Side | 04-05 | F(left) |
| YFM 700 RV/RW Raptor                 | 06-07 | F(left) |
| XTZ 750 "Super Tenere"               | 89-95 | F(left) |

### Competitor X Ref

| Dunlop | Ferodo | SBS | Vesrah |
|--------|--------|-----|--------|
| DP411  | FDB497 | 611 | VD-340 |

### Equivalent OE #

|             |              |              |
|-------------|--------------|--------------|
| 43082 1089  | 59300 27810  | 4TP W0045 00 |
| 43082 1093  | 59300 27850  | 5GF W0045 00 |
| 43082 1117  | 59300 27860  | 800070888    |
| 43082 1129  | 3JD W0045 00 | 800071450    |
| 59100 39850 | 3SP W0045 00 | 59100 09870  |
| 59300 08810 | 3XP W0045 00 | IS3 W0045 00 |
| 59300 09840 | 4EW W0045 00 | 5RM W0045 10 |
| 59300 09850 | 4EW W0045 01 | 800070858    |
| 59300 26830 | 4GY W0045 01 |              |
| 59300 27830 | 4MX W0045 00 |              |

| MATERIAL AVAILABILITY AND PART NO. |         |        |        |     |
|------------------------------------|---------|--------|--------|-----|
| STD                                | OPTIONS |        |        |     |
| FA                                 | HH      | R      | MXS    | GFA |
| FA135TT                            | -       | FA135R | MXS135 | -   |

**OVERSIZE VERSION AVAILABLE - REF: FA202**

# FA136 80 x 40 x 9.8mm

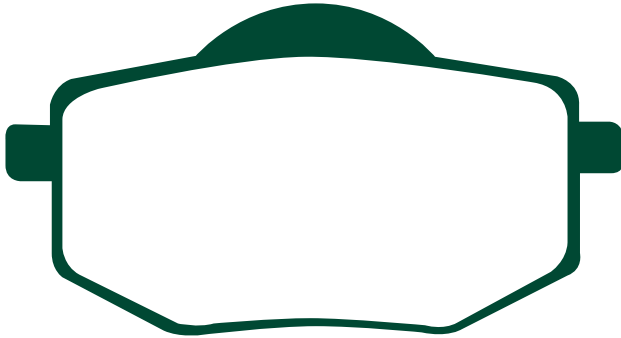

**YAMAHA**  
XV 535 Virago

88-94 F

**Equivalents OE #**

|              |
|--------------|
| 3JB W0045 00 |
|--------------|

**Competitor X Ref**

| MATERIAL AVAILABILITY AND PART NO. |         |   |     |     |
|------------------------------------|---------|---|-----|-----|
| STD                                | OPTIONS |   |     |     |
| FA                                 | HH      | R | MXS | GFA |
| FA136                              | -       | - | -   | -   |

| Dunlop | Ferodo | SBS | Vesrah |
|--------|--------|-----|--------|
| DP417  | FDB591 | 616 | VD246  |

# FA137 47 x 45.1 x 7.5mm

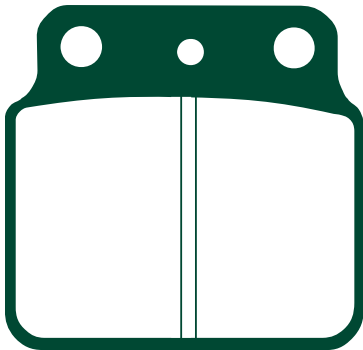

**ARCTIC CAT**

DVX 400 04-07 R

**KAWASAKI**

KSF 400 A1/A2/A3 (KFX 400) 03-05 R

**SUZUKI**

LT 250 RH/RJ/RK/RL 87-90 R

LT-Z 400 K3/K4/K5/K6/K7 03-07 R

LT-R 450 K6/K7 06-07 R

LT 500 RL 90 R

**Equivalents OE #**

|             |
|-------------|
| 43082 S007  |
| 69100 07810 |
| 69140 35B00 |
| 69140 43B00 |
| 69140 43B10 |
| 3406-075    |
| 69100 01810 |

**Competitor X Ref**

| MATERIAL AVAILABILITY AND PART NO. |         |        |     |     |
|------------------------------------|---------|--------|-----|-----|
| STD                                | OPTIONS |        |     |     |
| FA                                 | HH      | R      | MXS | GFA |
| FA137TT                            | -       | FA137R | -   | -   |

| Dunlop | Ferodo  | SBS | Vesrah |
|--------|---------|-----|--------|
| DP817  | FDB2016 | 649 | VD-341 |

# FA138 104.3 x 62.3 x 12 mm

**REFERRED TO FA201**

# FA139 104.3 x 62 x 11mm

**REFERRED TO FA200**

# FA140 86 x 40 x 10.2mm

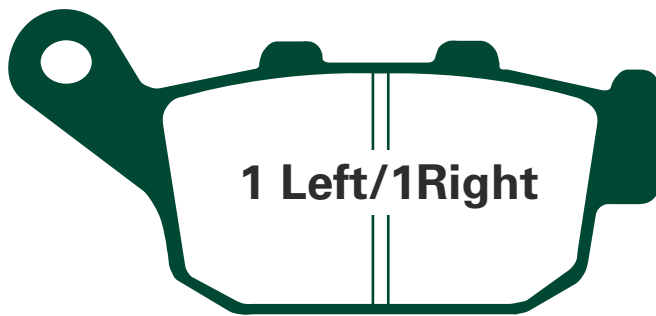

### Equivalents OE #

|                |                |               |
|----------------|----------------|---------------|
| 06435 KFG J21  | 43105 MN8 006  | 06435 KFG J21 |
| 06435 KT7 405  | 43106 KV3 831  | 754804        |
| 06435 KV3 405  | 43106 MN8 006  | H0301 T       |
| 43105 KT7 761A | 43105 MY1 405  | 06435 MY9 405 |
| 43105 KT7 762A | 43106 KT7 762B | 06435 KFK 006 |
| 43106 KT7 761B | 69100 04830    |               |
| 43105 KV3 831  | T2020602       |               |

### Competitor X Ref

| Dunlop | Ferodo | SBS | Vesrah |
|--------|--------|-----|--------|
| DP115  | FDB531 | 614 | VD-147 |

| MATERIAL AVAILABILITY AND PART NO. |         |   |     |     |
|------------------------------------|---------|---|-----|-----|
| STD                                | OPTIONS |   |     |     |
| FA                                 | HH      | R | MXS | GFA |
| FA140                              | FA140HH | - | -   | -   |

### HONDA

|   |       |   |
|---|-------|---|
| FES 125/150 3/4/5/6/7 Pantheon              | 03-07 | R |
| CB 250 FT/FV/FX/FY/F1 'Hornet'              | 96-01 | R |
| CBR 250 RH (MC17)                           | 87    | R |
| CBR 250 RJ/RK/RK2 (MC19)                    | 88-89 | R |
| CBR 250 RRL/RRN/RRR (MC22)                  | 90-94 | R |
| FES 250 Y/1/2/5 Foreight                    | 00-05 | R |
| NSR 250 R2J (MC18)                          | 88    | R |
| NSR 250 RSP/RSK/RSP (MC18)                  |       | R |
| NSR 250 RL/RN/RSP (MC21)                    | 95-   | R |
| VT 250 FL Spada/Castec                      | 88-90 | R |
| VTR 250 W/Y/1-7 (MC33)                      | 98-07 | R |
| CB-1 (CB 400 F)                             | 89-90 | R |
| NT 400 'Bros' NC25                          |       | R |
| CB 400 SF (F2N/F2R) "Superfour"             | 92-   | R |
| CB 400 SF (F2V/F3T) Superfour               | 96-97 | R |
| CB 400 SF (F3V) Superfour                   | 97    | R |
| CB 400 Four V/V-II/W/W-II (NC36)            | 97-98 | R |
| CBR 400 RRJ/K (NC23 Tri-arm)                | 92-93 | R |
| CBR 400 RRL/RRN/RRR (NC29 Gull-arm)         | 90-94 | R |
| VFR 400 RH2/RJ (NC24)                       | 87-88 | R |
| NX 500 J/K/L/M/N/P/R/S/T Dominator          | 92-96 | R |
| NTV 600 J/K/M Reverse                       | 88-92 | R |
| XL 600 VM/VN/VP/VR/VT/VV/VW/VX "Trans Alp"  | 91-00 | R |
| FMX 650 5/6                                 | 05-07 | R |
| NT 650 J/K/L 'Bros'                         | 88-92 | R |
| NT 650 V/W                                  | 98    | R |
| NTV 650 J/K/L/M/P/S/T/V                     | 88-97 | R |
| NX 650 J/K/L/LII/M/N/P/R/S/T "Dominator"    | 88-   | R |
| NT 650 VV/VX/VY/V1 "Deauville"              | 98-01 | R |
| XL 650 VY/V1/V2/V3/V4/V5/V6/V7 Transalp     | 00-07 | R |
| XRV 650 J Africa Twin                       | 88-89 | R |
| XRV 750 L/M/N/P/R/S/T/V/W/X/Y "Africa Twin" | 90-03 | R |

### BUELL

|                    |       |   |
|--------------------|-------|---|
| X1 Lightning       | 99-02 | R |
| M2 Cyclone         | 98-02 | R |
| S1 Lightning       | 98-02 | R |
| S1 White Lightning | 98-02 | R |
| S3 Thunderbolt     | 98-02 | R |
| S3T Thunderbolt    | 98-02 | R |
| XB9R               | 02-07 | R |
| XB9S               | 03-07 | R |
| XB9SX              | 05-07 | R |
| XB12R              | 04-07 | R |
| XB12S              | 04-07 | R |
| XBRX Ulysses       | 06-07 | R |
| XB12 SCG           | 06-07 | R |
| XB12SS             | 06-07 | R |

### PEUGEOT

|        |       |   |
|--------|-------|---|
| SV 250 | 01-02 | R |
|--------|-------|---|

### SUZUKI

|                         |       |   |
|-------------------------|-------|---|
| XF 650 V/W/X/Y Freewind | 97-02 | R |
|-------------------------|-------|---|

### TRIUMPH

|               |       |   |
|---------------|-------|---|
| Daytona 600   | 03-04 | R |
| Daytona 955i  | 01-04 | R |
| Speedfour 600 | 02-05 | R |
| TT 600        | 00-03 | R |
| Daytona 675   | 06    | R |

DISC PADS BUYERS GUIDE

# FA141 A. 106 x 38.2 x 9mm B. 76.4 x 27 x 10.7mm

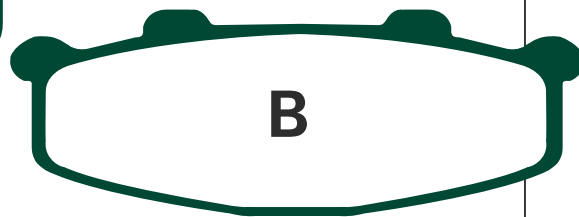

### KAWASAKI

|                              |       |     |
|------------------------------|-------|-----|
| KR-1 (KR 250 B2)             | 89    | F&R |
| KR1S (KR 250C2/C3)           | 90-92 | R   |
| GPX 250 R (ZX 250 F2-F9)     | 88-95 | R   |
| GPX 250 R (EX 250 F)         | 87    | R   |
| GPX 250 R II (EX 250 G)      | 88    | F&R |
| ZXR 250 C1-C5 (ZX 250 C1-C5) | 91-95 | F   |
| ZXR 250 R (ZX 250 D1)        | 91    | F   |
| ZXR 250 (ZX 250 A1/A2)       | 89/90 | F&R |
| ZXR 250 R (ZX 250 B1/B2)     | 89-90 | F&R |
| GPX 400 R (ZX 400 F1)        | 87    | F   |
| GPZ 400 R 'D4'               | 88    | F   |
| ZR 400 D1/D3/D4 'Zanthus'    | 92-95 | F   |
| ZX-4 (ZX 400 G1/G1A/G1B)     | 88    | F&R |
| GPZ 500 S (EX 500 E1-E10)    | 94-04 | F   |
| ZR 550 B2/B3 'Zephyr'        | 91-93 | R   |

### SUZUKI

|                               |       |   |
|-------------------------------|-------|---|
| RGV 250 M/N/P/R/S/T           | 91-96 | R |
| RGV 250 T (RGVR 250 SP VJ23A) | 96    | R |

### Equivalents OE #

|            |             |
|------------|-------------|
| 43082 1075 | 43082 1144  |
| 43082 1076 | 43082 1147  |
| 43082 1085 | 43082 1162  |
| 43082 1087 | 69100 22820 |
| 43082 1101 | 69100 22830 |
| 43082 1125 | 69100 22850 |
| 43082 1127 |             |

### Competitor X Ref

| Dunlop | Ferodo | SBS | Vesrah |
|--------|--------|-----|--------|
| DP204  | FDB508 | 615 | VD-430 |

| MATERIAL AVAILABILITY AND PART NO. |         |   |     |     |
|------------------------------------|---------|---|-----|-----|
| STD                                | OPTIONS |   |     |     |
| FA                                 | HH      | R | MXS | GFA |
| FA141                              | -       | - | -   | -   |
| FA141S (Green)                     |         |   |     |     |

# FA142 102 x 38 x 9mm

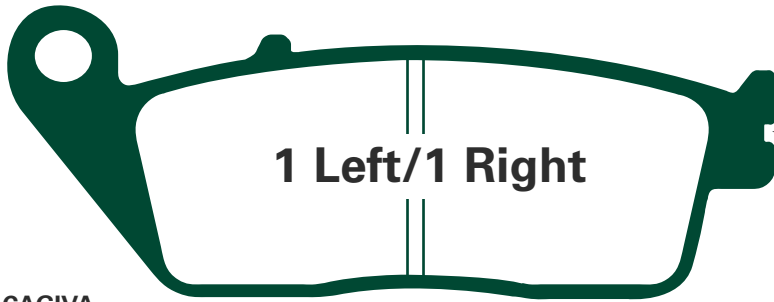

## NOTE

Later supplies have clip notch. Both designs ok for front brake use

### CAGIVA

900 IE Canyon/'Gran Canyon' 98-00 F  
Navigator 1000 00-05 F

### DAELIM

SQ 125 Freewing S2 06 F  
SQ 250 Freeway S2 06 F

### HONDA

CBR 250 RJ/RK/RK2 (MC19) 88-89 F  
CBR 250 RRL/RRN/RRR (MC22) 90-94 F  
VT 250 FL Spada/Castec 88-90 F  
CB-1 (CB 400 F) 89-90 F  
CB 400 SF "Superfour" (F2N/F2R) 92- F  
CB 400 Four V/V-II/W/W-II (NC36) 97-98 F  
CBR 400 RRJ/K (NC23 Tri-Arm) 92-93 F  
CBR 400 RRL/RRN/RRR (NC29 Gull Arm) 90-94 F  
NV 400 CS/CV 'Steed' 95-97 F  
NTV 600 J/K/M Revere 88-92 F  
VT 600 CR/CS/CT/CV/CW/CX 'Shadow Custom' 94-99 F  
NTV 650 J/K/L/M/P/S/T/V 88-97 F  
NX 650 J/K/L/LII/M/N/P/R/S/T/V 88-97 R  
CBR 750 FJ "Superaero" 88 F  
VFR 750 FJ/FK/FL/FM/FN/FP/FR/FS/FT/FV 88-97 F  
CB 750 F2N/F2R/F2S/F2T/F2V/F2W/F2X/F2Y/F21  
'CB Seven fifty' 92-02 F  
PC 800 'Pacific Coast' 89-97 F  
CBR 1000 FK/FL/FM/FN 89-92 F  
ST 1100 L/M/N/P/R/S/T/V/W/X/Y1  
"Pan European" 90-01 F  
ST 1100 AN/AP/AR/AS 92-95 F  
GL 1500 'CV/CW/CX/CY/C1/C2' (F6C) 97-03 F

### KAWASAKI

Z 750 (ZR 750 L7F) 07 F  
Z 750 ABS (ZR 750 M7F) 07 F

### KYMCO

Xciting 250/250 i 05-07 F  
Xciting 500/500i 04-07 F

### PEUGEOT

Satelis 125 (ABS Model) 06 F

### SUZUKI

GSX 400 R/S/T/ZR/ZS/ZT "Impulse Type" 94-96 F  
RF 400 RP/RR/VR/RT/RVT/RV-V (GK78A) 93-97 F  
RF 600 RP/RR/RS/RT/RV 93-97 F  
GSF 600 S/T/ST/V/SV/W/SW/X/SX "Bandit" 95-99 F  
AN 650 K3/K4/AK4/AK5/K5/AK6/AK7 Burgman 03-07 F

### TRIUMPH

Thruxton 900 04-07 F

### VOXAN

Scrambler 1000 02-06 F

### Equivalents OE #

|                   |                   |
|-------------------|-------------------|
| 06455 MR1 405     | 45106 ML7 922B    |
| 06455 MR4 405     | 45106 MR4 901     |
| 06455 MW3 405     | 45106 MS9 612     |
| 06455 MV4 405     | 45106 MT4 651/405 |
| 06455 MZ0 760     | 59300 21820       |
| 451A0 MT4 670     | 59300 21840       |
| 45105 ML7 921/922 | 59300 21850       |
| 45105 MS9 612     | 8000 88482        |
| 45105 MT4 651/405 | 06455 MBE 006     |
| 45105 KAZ 004     | 59100 21860       |
| 45105 MV4 008     | 59100 21870       |
| 45105 ML7 405     | 06455 KFR 701     |
| 45105 ML7 P10     | T2020537          |
| 45106 ML7 922     |                   |

### Competitor X Ref

| Dunlop | Ferodo | SBS | Vesrah |
|--------|--------|-----|--------|
| DP117  | FDB570 | 627 | VD-156 |

### MATERIAL AVAILABILITY AND PART NO.

| STD   | OPTIONS |   |     |     |
|-------|---------|---|-----|-----|
| FA    | HH      | R | MXS | GFA |
| FA142 | FA142HH | - | -   | -   |

# FA143 94.2 x 32 x 10mm



### HONDA

NSR 250 RR/R2R (MC28) 94- R  
RVF 400 RR/RR-II/RT/RT-II (NC35) 94-96 R  
VFR 400 RK/R3L/R3M/R3N (NC30) 89-92 R  
VFR 750 RJ/RK/RL (RC30) 88-90 R  
RVF 750 RR/RS 'RC45' 94-98 R

### Competitor X Ref

| Dunlop | Ferodo | SBS | Vesrah   |
|--------|--------|-----|----------|
| DP113  | FDB496 | 623 | VD-139/2 |

### Equivalents OE #

|                |                |
|----------------|----------------|
| 06435 MR7 P00  | 43105 MT7 405  |
| 43105 MR7 007A | 43106 MR7 007B |
| 43105 MR7 017A | 43106 MR7 017B |

### MATERIAL AVAILABILITY AND PART NO.

| STD   | OPTIONS |   |     |     |
|-------|---------|---|-----|-----|
| FA    | HH      | R | MXS | GFA |
| FA143 | -       | - | -   | -   |



# FA144 use FA187

## FA145 70 x 55.5 x 8 mm

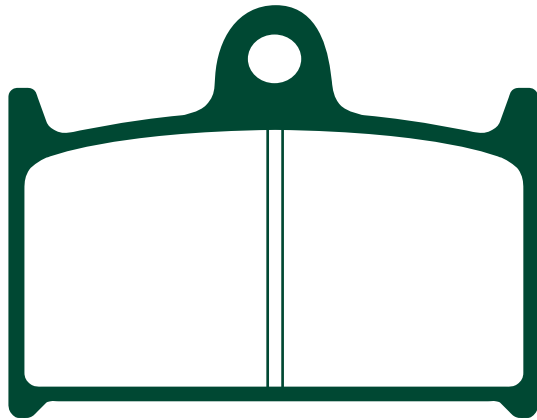

### SUZUKI

|   |       |   |
|---|-------|---|
| GSXR 400 RL/RM/RN/RS (GK76A)              | 90-95 | F |
| GSXR 750 J/K/L/M/WN/WP                    | 88-93 | F |
| GSXR 750 RG                               | 86    | F |
| RF 900 RR/RS/RS2/RT/RV/RW                 | 94-98 | F |
| GSXR 1100 K/L/M/N                         | 89-92 | F |
| GSF 1200 T/STV/SV/W/SW/X/SX/S/SY 'Bandit' | 96-00 | F |
| GSF 1200 SAV ABS Bandit                   | 97    | F |

### YAMAHA

|                  |       |   |
|------------------|-------|---|
| TZ 125           | 94-   | F |
| TZ 250           | 89-02 | F |
| FZR 750 R "OWOI" | 89-90 | F |

### MZ/MUZ

|          |       |   |
|----------|-------|---|
| 1000 S   | 03-07 | F |
| 1000 SF  | 05-07 | F |
| 1000 SFX | 07    | F |
| 1000 ST  | 07    | F |

### Equivalents OE #

|             |              |
|-------------|--------------|
| 59100 33830 | 59300 17810  |
| 59100 40810 | 59300 17811  |
| 59130 17C00 | 3FV W0045 00 |
| 59130 33C00 | 3LC 25811 00 |
| 59130 33C10 | 3MW W0045 00 |
| 59130 40C00 | 3TC W0045 00 |

### Competitor X Ref

| Dunlop | Ferodo | SBS | Vesrah |
|--------|--------|-----|--------|
| DP213  | FDB557 | 624 | VD343  |

### MATERIAL AVAILABILITY AND PART NO.

| STD   | OPTIONS |   |     |          |
|-------|---------|---|-----|----------|
| FA    | HH      | R | MXS | GFA      |
| FA145 | FA145HH | - | -   | GFA145HH |

## FA146 58.8 x 57.1 x 9mm

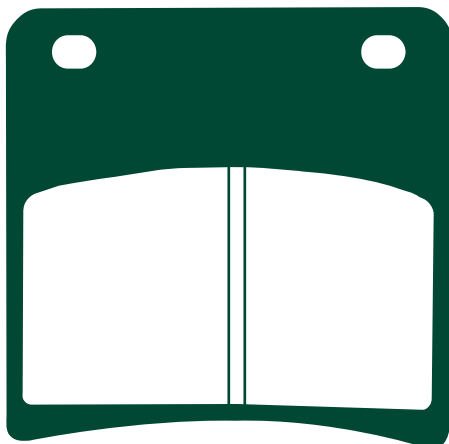

### SUZUKI

|                                       |       |   |
|---------------------------------------|-------|---|
| GSX 400 FJ/FK/FAK/FL (GK74A)          | 88-90 | F |
| GSX 600 FJ/FK/FL/FM/FN/FP/FR/FS/FT/FV | 88-97 | F |
| GSX 750 FK/FL/FM/FN/FP/FR/FS/FT/FV    | 89-97 | F |
| VX 800 L/M/N/P/R                      | 90-96 | R |
| GSX 1100 FJ/FK/FL/FM/FN/FP            | 88-93 | F |
| GSX 1100 GM/GN                        | 91-94 | R |
| GV 1400 GDG/GCG/GDH/GDJ "Cavalcade"   | 86-88 | F |

### Equivalents OE #

|             |             |
|-------------|-------------|
| 59100 19820 | 69100 34860 |
| 59100 24810 | 69100 45890 |
| 59130 19C00 | 69130 34C00 |
| 59130 20C00 | 69130 45C00 |
| 59130 24A10 | 69130 45C10 |
| 59130 26D00 | 69130 26D00 |
| 59130 45C10 | 69100 26810 |
| 59130 48B00 |             |

### MATERIAL AVAILABILITY AND PART NO.

| STD   | OPTIONS |   |     |     |
|-------|---------|---|-----|-----|
| FA    | HH      | R | MXS | GFA |
| FA146 | FA146HH | - | -   | -   |

### Competitor X Ref

| Dunlop | Ferodo | SBS | Vesrah   |
|--------|--------|-----|----------|
| DP212  | FDB569 | 620 | VD-345/2 |

# FA147 A. 118 x 48 x 8.6mm B. 97.5 x 57 x 10.8mm

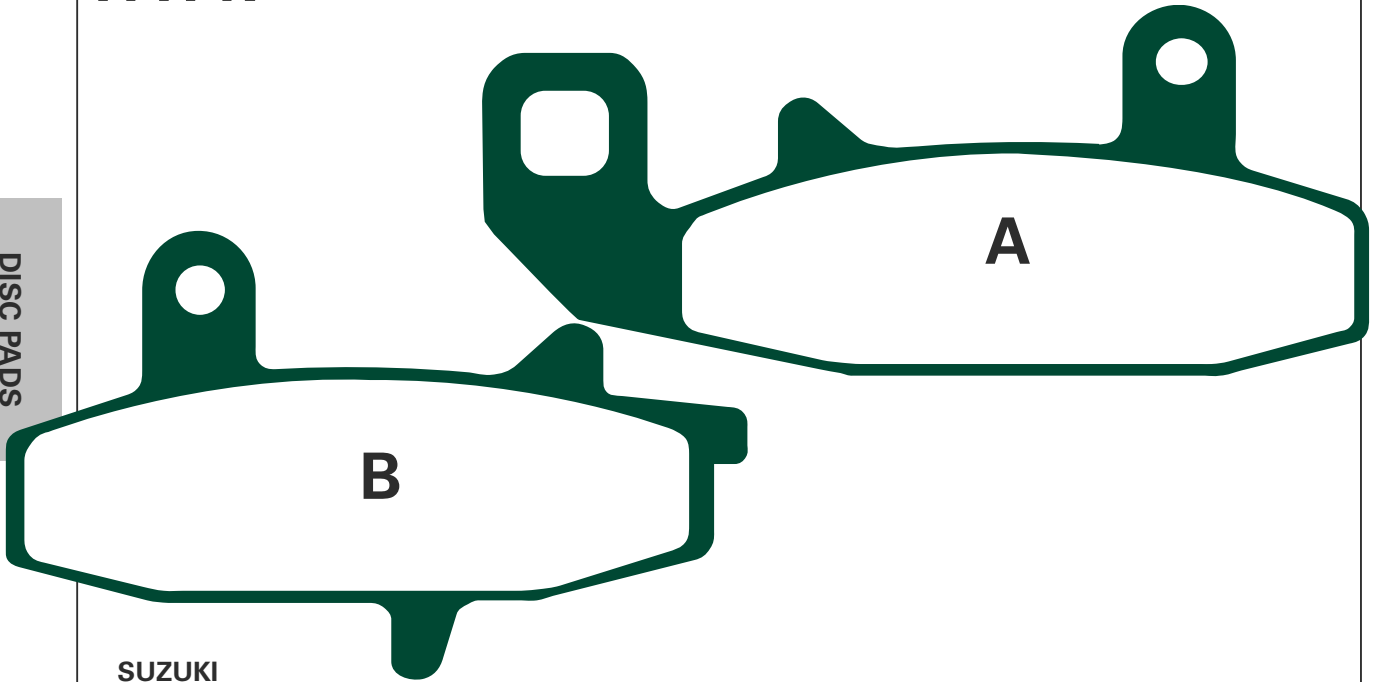

## SUZUKI

|                                |       |   |
|--------------------------------|-------|---|
| DR 650 RSEM/RSEN/RSEP/RES      | 91-95 | F |
| DR 650 RL/RM (SP41A)           | 90-91 | F |
| DR 650 RSL/RSM (SP42A)         | 90-91 | F |
| DR 650 RUN/RN/RUP/RP (SP44A/B) | 92-93 | F |
| DR 750 SJ/SK                   | 88-89 | F |
| DR 800 SL                      | 90    | F |

### Equivalents OE #

59300 44850

### Competitor X Ref

| MATERIAL AVAILABILITY AND PART NO. |         |        |     |     |
|------------------------------------|---------|--------|-----|-----|
| STD                                | OPTIONS |        |     |     |
| FA                                 | HH      | R      | MXS | GFA |
| FA147                              | -       | FA147R | -   | -   |

| Dunlop | Ferodo | SBS | Vesrah |
|--------|--------|-----|--------|
| DP214  | FDB606 | 626 | VD-347 |

# FA150 57.3 x 59 x 9mm

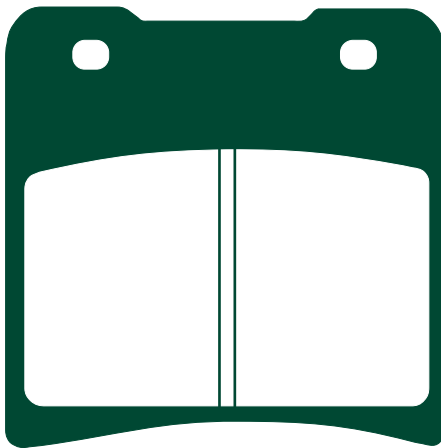

## SUZUKI

|                                 |       |   |
|---------------------------------|-------|---|
| GV 1400 GDG/GCG/GDH/GDJ/GCH     | 86-88 | R |
| 'Cavalcade' (from f.no -103765) |       |   |

### Equivalents OE #

|             |             |
|-------------|-------------|
| 69100 24860 | 69130 24A03 |
| 69130 24A02 | 69130 24A04 |

### Competitor X Ref

| Dunlop | Ferodo | SBS | Vesrah  |
|--------|--------|-----|---------|
| -      | FDB831 | -   | VD331/2 |

| MATERIAL AVAILABILITY AND PART NO. |         |   |     |     |
|------------------------------------|---------|---|-----|-----|
| STD                                | OPTIONS |   |     |     |
| FA                                 | HH      | R | MXS | GFA |
| FA150                              | FA150HH | - | -   | -   |

# FA151 51 x 36.5 x 8.3mm

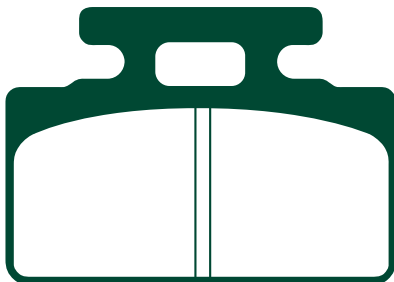

## HONDA

|            |       |   |
|------------|-------|---|
| RS 125/250 | 88-06 | R |
|------------|-------|---|

## SYM

|                   |       |   |
|-------------------|-------|---|
| Cinderella 50/100 | 99-00 | F |
| DD 50 City Trek   | 02-06 | F |
| MIO 50/100        | 05-07 | F |

### Competitor X Ref

| Dunlop | Ferodo  | SBS | Vesrah |
|--------|---------|-----|--------|
| DP119  | FDB2192 | 618 | VD-150 |

### Equivalents OE #

|               |                |
|---------------|----------------|
| 43105 NF5 611 | 45105 GM9 742  |
| 45105 GH9 710 | 45105 GM9 743  |
| 45105 GM9 741 | 45105 GM9 743A |

| MATERIAL AVAILABILITY AND PART NO. |         |   |     |     |
|------------------------------------|---------|---|-----|-----|
| STD                                | OPTIONS |   |     |     |
| FA                                 | HH      | R | MXS | GFA |
| FA151                              | -       | - | -   | -   |

**FA152 62 x 40.8 x 9mm**

**FA152/2 62 x 40.8 x 11mm**

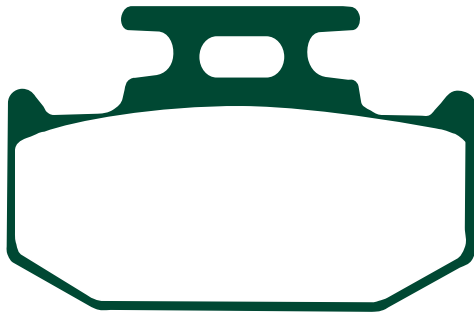

**NOTE:  
ANTI RATTLE SHIMS MUST BE  
DISCARDED TO USE THICKER PAD**

**Competitor X Ref**

| Dunlop | Ferodo | SBS     | Vesrah   |
|--------|--------|---------|----------|
| DP315  | FDB659 | 632/648 | VD-432/2 |

| MATERIAL AVAILABILITY AND PART NO. |         |        |        |     |
|------------------------------------|---------|--------|--------|-----|
| STD                                | OPTIONS |        |        |     |
| FA                                 | HH      | R      | MXS    | GFA |
| FA152TT                            | -       | FA152R | MXS152 | -   |

**Equivalents OE # -FA152**

|            |              |
|------------|--------------|
| 43082 1090 | 69100 15810  |
| 43082 1118 | 69140 03D00  |
| 43082 1131 | 69140 15D00  |
| 43082 1137 | 69140 28C00  |
| 43082 1151 | 5XT W0046 50 |

| MATERIAL AVAILABILITY AND PART NO. |         |          |          |     |
|------------------------------------|---------|----------|----------|-----|
| STD                                | OPTIONS |          |          |     |
| FA                                 | HH      | R        | MXS      | GFA |
| FA152/2TT                          | -       | FA152/2R | MXS152/2 | -   |

**Equivalents OE # -FA152/2**

|             |             |              |              |
|-------------|-------------|--------------|--------------|
| 69100 43820 | 69140 26C00 | 69140 43840  | 4GV FS811 00 |
| 69100 43840 | 69140 27C10 | 3SP W0046 00 | 4GY W0046 00 |
| 69100 43850 | 69140 27C20 | 3XP W0046 00 | 5GF W0046 00 |
| 69140 05D00 | 69140 43D00 | 4DA W0046 00 |              |

**FA152  
CANNONDALE**

|                          |       |   |
|--------------------------|-------|---|
| MX 400                   | 00    | R |
| <b>KAWASAKI</b>          |       |   |
| KX 125 G1/H1/H2/J1/J2/K1 | 89-94 | R |
| KDX 125 A1/A2/B1/B2      | 90-94 | R |
| KDX 200 E1-E6            | 89-94 | R |
| KDX 200 H1-H5            | 95-99 | R |
| KDX 200 SR (DX 200 G)    |       | R |
| KDX 220 R A4-A12/A6F     | 97-06 | R |
| KDX 220 SR (DX 220 B)    |       | R |
| KDX 250 SR (KDX 250 F1)  | 91    | R |
| KX 250 G1/H1/H2/J1/J2/K1 | 89-94 | R |
| KDX 250 D1               | 91-93 | R |
| KLX 250 R D1/D2/G1       | 93-97 | R |
| KLX 250 F1-F4            | 94-97 | R |
| KX 500 E1-E7             | 89-95 | R |
| KLX 650 C1-C3            | 93-97 | R |

**SUZUKI**

|  |       |   |
|--|-------|---|
| TS 125 RK/RL/RM/RN/RR  | 90-96 | R |
| RM 125/250 K/L/M   | 89-91 | R |
| TS 200 RK/RL/RM/RN/RR  | 89-94 | R |
| DR 250 RS/RLS/RT/RV/RLV/RLW/RW/RX<br>(SJ45A/DOHC)  | 95-00 | R |
| DR 250 RXT/RXLT/RXV/RXLV/RXW/RXLW/RXGW/RXGLW<br>/RXY/RXGY (Dejbel 250 XC/GPS Ver (SJ45A) |       | R |
| DR 250 SL/SM/SN/SEP/SER/SES  | 90-95 | R |
| RMX 250 K/M/N/P  | 89-93 | R |
| RMX 250 T/V/W  | 96-98 | R |
| Serrow 250 (3C51/52)   | 05    | R |
| XT 250 X   | 06    | R |
| DR 350 SL/SM/SN/SP/SER/SES   | 91-95 | R |
| DR 350 SET/SEV   | 96-99 | R |
| DR 650 SET   | 96    | R |

**YAMAHA**

|                             |       |   |
|-----------------------------|-------|---|
| DT 125 RE                   | 05-07 | R |
| DT 125 X                    | 05-06 | R |
| YZ 125 A/B                  | 90-91 | R |
| TT 250 RL/RM/RN/RR/RS       | 99-04 | R |
| XG 250 Tricker (5XT1)       | 04-06 | R |
| YZ 250 A/WRA/B              | 90-91 | R |
| WR 200 D/E/F                | 92-94 | R |
| WR 250 ZB/ZD/ZE/ZF/ZG/ZH/ZJ | 91-97 | R |
| YZ 400 FK                   | 98    | R |
| WR 500 ZD                   | 92    | R |
| TT 600 RES                  | 04    | R |

**FA152/2**

**SUZUKI**

|                          |       |   |
|--------------------------|-------|---|
| RM 125 N/P/R/S           | 92-95 | R |
| DR-Z 250 K1-K7           | 01-07 | R |
| RM 250 N/P/R/S           | 92-95 | R |
| RMX 250 R/S              | 94-95 | R |
| RMX 250 SN/SR/SS (SJ13A) | 95-97 | R |
| DR 350 SEW/SEX           | 98-99 | R |

**YAMAHA**

|  |       |   |
|--|-------|---|
| YZ 125 D/E/F/G/H/J                     | 92-97 | R |
| DT 200 WR (3XP)                        | 92-93 | R |
| XT 225 W (4JG1-6 Serrow)               | 93-98 | R |
| DT 230 (4TP1/2) Lanza                  | 97-96 | R |
| TT 250 R (4GY) Raid/4MR2               | 96    | R |
| YZ 250 D/E/F/G/H/J                     | 92-97 | R |
| YZ 400 FK/WR 400 FK                    | 98    | R |
| WR 400 FK                              | 98    | R |
| TT 600 E (4GV2)                        | 94-95 | R |
| TT 600 K (4LW1/4GV1/4LW2)              |       | R |
| Up to 4GV 003403 (Nissin rear caliper) | 93-95 | R |

# FA153 75 x 40 x 8mm

## HONDA

|   |       |   |
|---|-------|---|
| AX-1 (NX 250 J/K/R/R3)                      | 89-94 | R |
| CRM 250 R (RK) MK1 MD24<br>(100001-1008385) | 89-90 | R |
| XLR 250 R (MD22)                            | 88-90 | R |
| XLR 250 Baja MK2 (MD22)                     |       | R |

### Equivalents OE #

|                |
|----------------|
| 43106 KW3 006B |
| 43106 KZ9 006B |

### Competitor X Ref

| Dunlop | Ferodo | SBS | Vesrah |
|--------|--------|-----|--------|
| DP120  | FDB568 | 629 | VD-153 |



| MATERIAL AVAILABILITY AND PART NO. |         |   |     |     |
|------------------------------------|---------|---|-----|-----|
| STD                                | OPTIONS |   |     |     |
| FA                                 | HH      | R | MXS | GFA |
| FA153                              | -       | - | -   | -   |

# FA155 40 x 23/7.8mm

## YAMAHA

|                                       |       |   |
|---------------------------------------|-------|---|
| YFS 200 B/F/G/H/J/K/L/M/N/P "Blaster" | 91-02 | R |
|---------------------------------------|-------|---|

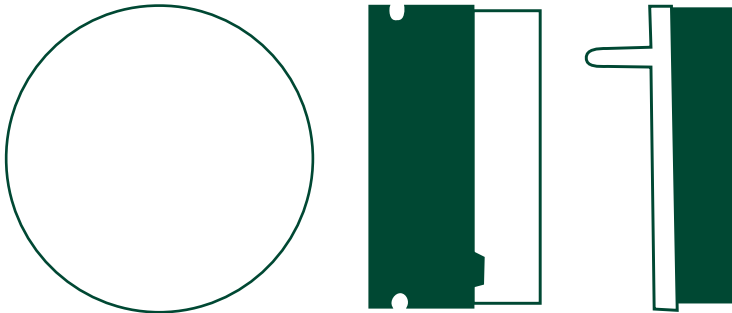

### Equivalents OE #

|              |
|--------------|
| 2XJ 25811 00 |
|--------------|

### Competitor X Ref

| Dunlop | Ferodo  | SBS | Vesrah |
|--------|---------|-----|--------|
| DP843  | FDB2017 | 637 | VD261  |

| MATERIAL AVAILABILITY AND PART NO. |         |        |     |     |
|------------------------------------|---------|--------|-----|-----|
| STD                                | OPTIONS |        |     |     |
| FA                                 | HH      | R      | MXS | GFA |
| FA155                              | -       | FA155R | -   | -   |

# FA156 55.8 x 45.5 x 6mm

## APRILIA

|             |       |   |
|-------------|-------|---|
| 280 Climber | 94-96 | R |
|-------------|-------|---|

## BETA

|           |       |   |
|-----------|-------|---|
| Synt/Gara | 93-95 | R |
| Techno    | 95    | R |

## CAGIVA

|                  |       |   |
|------------------|-------|---|
| Blues 50         | 93-95 | F |
| Super City 50/80 | 93-95 | F |
| Prima 50         | 92-94 | F |



### Competitor X Ref

| Dunlop | Ferodo | SBS | Vesrah |
|--------|--------|-----|--------|
| -      | FDB886 | 672 | VD-943 |

### Equivalents OE #

|           |
|-----------|
| 800066937 |
|-----------|

| MATERIAL AVAILABILITY AND PART NO. |         |   |     |     |
|------------------------------------|---------|---|-----|-----|
| STD                                | OPTIONS |   |     |     |
| FA                                 | HH      | R | MXS | GFA |
| FA156                              | -       | - | -   | -   |

# FA157 A. 99.3 x 44 x 7.4mm B. 47.7 x 83.3 x 9.7mm

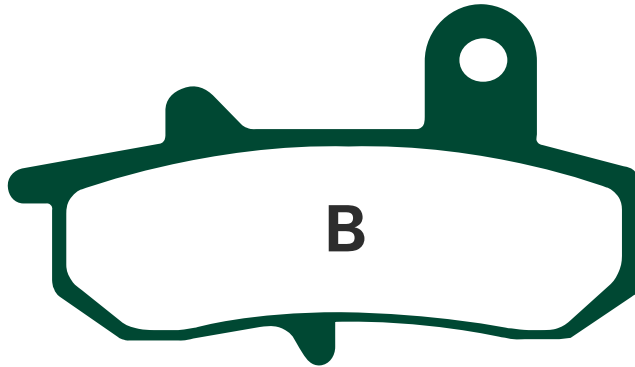
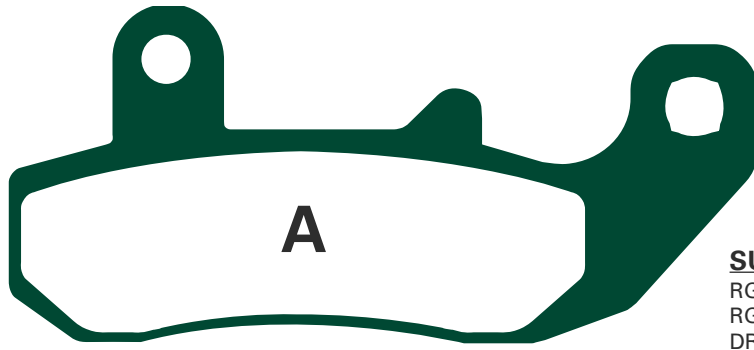

**Equivalents OE #**

|             |
|-------------|
| 69100 44860 |
| 69100 12810 |

**SUZUKI**

|                               |       |   |
|-------------------------------|-------|---|
| RG 125 FUN/FUP/FUR 'Gamma'    | 92-96 | R |
| RG 125 UN 'Wolf'              | 92-94 | R |
| DR 650 RSEM/RSEN/RSEP/RES     | 91-95 | R |
| DR 650 RL/RM (SP41A)          | 90-91 | R |
| DR 650 RSL/RSM (SP42A)        | 90-91 | R |
| D 650 RUN/RN/RUP/RP (SP44A/B) | 92-93 | R |
| DR 750 SK                     | 89    | R |
| DR 800 SL                     | 90    | R |

**YAMAHA**

|                           |       |   |
|---------------------------|-------|---|
| DTZ 125 Tenere/Tenere     | 89-90 | R |
| DT 125 Chesterfield Scout | 89-90 | R |

**Competitor X Ref**

| Dunlop | Ferodo | SBS | Vesrah     |
|--------|--------|-----|------------|
| DP215  | FDB607 | 635 | VD-348/940 |

**MATERIAL AVAILABILITY AND PART NO.**

| STD   | OPTIONS |    |        |     |
|-------|---------|----|--------|-----|
|       | FA      | HH | R      | GFA |
| FA157 | -       | -  | FA157R | -   |

# FA158 46.7 x 69.8 x 8mm

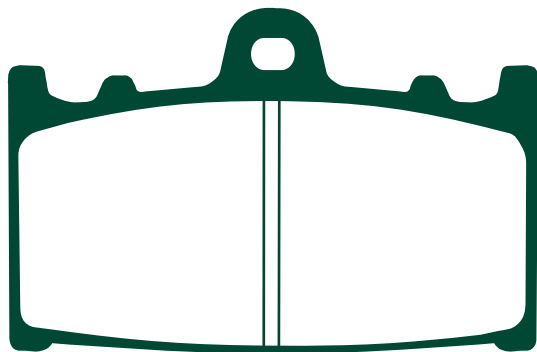

**Equivalents OE #**

|            |             |             |
|------------|-------------|-------------|
| 43082 1097 | 59100 22810 | 59130 32C20 |
| 43082 1102 | 59100 32820 | 59130 38C00 |
| 43082 1110 | 59100 34830 | 59300 34830 |
| 43082 1111 | 59130 06C00 | 59100 35830 |
| 43082 1113 | 59130 22D00 | 59100 35850 |
| 43082 1120 | 59130 32000 | 43082 0015  |
| 43082 1142 | 59130 32020 | 43082 1169  |
| 43082 1208 | 59130 32C00 | 2654F/S/R2  |
| 43082 1288 | 59130 32C10 |             |

**Competitor X Ref**

| Dunlop | Ferodo | SBS | Vesrah     |
|--------|--------|-----|------------|
| DP317  | FDB574 | 631 | VD-343/344 |

**BERINGER**

4 Piston Caliper

**KAWASAKI**

|                                       |       |   |
|---------------------------------------|-------|---|
| KRIS (KR 250 C2/C3)                   | 90-92 | F |
| ZR 400 Zephyr (G2/G3/G3A/G4/G5)       | 97-01 | F |
| ZXR 400 H1/H2                         | 89-90 | F |
| ZXR 400 J1/J2                         | 89-90 | F |
| ZXR 400 R (ZX 400 M1-M4)              | 91-94 | F |
| ZZR 400 (ZX 400 K1/K2/K3)             | 90-92 | F |
| ZZR 400 (ZX 400 N1/N2/N3/N4/N5/N6/N7) | 93-99 | F |
| ZZR 600 (ZX 600 D1-D3)(E1-E13)        | 90-05 | F |
| ZZR 600 (ZX 600 E6F)                  | 06-07 | F |
| ZX6 R (ZX 600 F1/F2/F3)               | 95-97 | F |
| ZXR 750 H1/H2/J1/J2/K1/K2/L1/L2       |       |   |
| L3/M1/M2                              | 89-95 | F |
| GPz 900 R A7/A8                       | 90-96 | F |
| GPZ 900 R (ZX 900 A11)                | 98    | F |
| ZX9 R (ZX 900 B1/B2)                  | 94-95 | F |
| ZZR 1100 (ZX 1100 C1-C3) (D1-D9)      | 90-01 | F |
| ZR 1100 A1-A4 'Zephyr'                | 92-95 | F |
| ZZR 1200 C1H/C2H                      | 02-04 | F |
| VN 2000 A1/A2/A6F/F7F                 | 04-07 | F |

**SUZUKI**

|                                    |       |   |
|------------------------------------|-------|---|
| RG 125 FUN/FUP/FUR 'Gamma'         | 92-96 | F |
| GSXR 250 RK (GJ73A)                |       | F |
| RGV 250 J/K/L/M/N/P/R/S            | 88-95 | F |
| TV 250 J/K/AK/L (VJ21A) Wolf       | 88-90 | F |
| SG 350 N 'Goose'                   | 92    | F |
| GSF 400 K/NK/Z/VM/VZM/P/NP/VP      |       |   |
| /VZP/VR (GK75A) "Bandit"           | 89-94 | F |
| GSF 400 S/VS/V-VZ-V Bandit (GK7AA) | 95-97 | F |
| GSXR 400 J/RR/RAK (GK73A)          | 88-90 | F |
| GSXR 400 K6                        | 06    | F |
| GSX 400 SSN (GK77A) Katana         | 92    | F |
| GSR 600 K6/AK7                     | 06-07 | F |
| GSXR 600 V/W/X/Y/K1/K2/K3/ZK3      | 97-03 | F |
| GSF 650 AK7/ASK7/AK6/ASK6          | 06-07 | F |
| GSXR 750 Y/K1/K2/K3                | 00-02 | F |
| SV 1000 SK3/K3/SK4/K4/SK5/K5/SK6   | 03-06 | F |
| TL 1000 SV/SW/SX/SY/SK1            | 97-01 | F |
| GSF 1200 AK6/SAK6/GTSAK6           | 06    | F |
| GSF 1250 AK7/ASK7 Bandit           | 07    | F |

**PRE TECH**

4 piston (P402) Lockheed replacement caliper

**PRO ONE**

4 Piston

**VERTEMATI**

4 Piston Caliper 99-04 F

**MATERIAL AVAILABILITY AND PART NO.**

| STD   | OPTIONS |    |   |          |
|-------|---------|----|---|----------|
|       | FA      | HH | R | GFA      |
| FA158 | FA158HH | -  | - | GFA158HH |

# FA159 97 x 40 x 7mm



**DANGER MUST BE FITTED IN COMPLETE FRONT AXLE SETS TO AVOID PULLING LEFT OR RIGHT**

### POLARIS

All Models 89- F

### QUADZILLA

Quadzilla 300 Utility 04-06 F  
300 E SUV (Manual) 06-07 F  
300 E SUV (Automatic) 06 F  
300 E (4x4) (Auto) 06 F  
500 4X4 06-07 F

#### Equivalents OE #

|         |         |         |
|---------|---------|---------|
| 1930731 | 2200418 | 22245   |
| 2200465 | 2201398 | 2201149 |
| 2200901 | 2202412 | 1911171 |

#### Competitor X Ref

|                        |                          |                   |                         |
|------------------------|--------------------------|-------------------|-------------------------|
| <b>Dunlop</b><br>DP902 | <b>Ferodo</b><br>FDB2055 | <b>SBS</b><br>642 | <b>Vesrah</b><br>VD-940 |
|------------------------|--------------------------|-------------------|-------------------------|

#### MATERIAL AVAILABILITY AND PART NO.

| STD     | OPTIONS |        |     |     |
|---------|---------|--------|-----|-----|
| FA      | HH      | R      | MXS | GFA |
| FA159TT | -       | FA159R | -   | -   |

# FA160 74.8 x 53.9 x 10mm

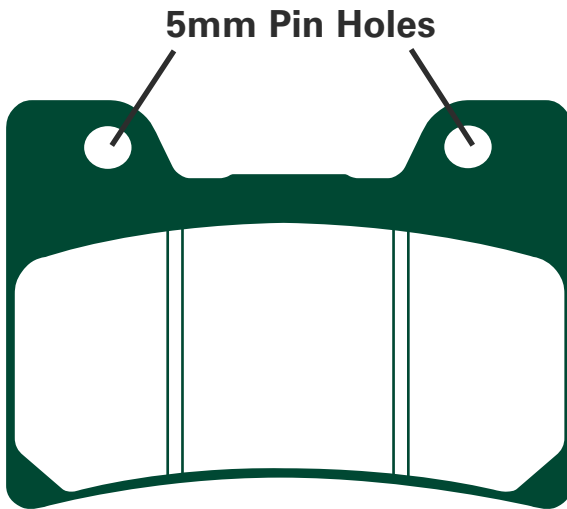

For later pad FZR 1000 92-93 with 6mm pin holes use FA182

### MZ

850 KBT 95 F

### YAMAHA

FZR 600 90-93 F  
FZR 600 R 94-95 F  
TDM 850 96-01 F  
FZR 1000 EX UP 89-90 F  
V-MAX 12 93-03 F  
FJ 1200 A (ABS Model) 91-95 F

#### Equivalents OE #

|              |              |
|--------------|--------------|
| 3GM W0045 00 | 3GM W0045 11 |
| 3GM W0045 01 |              |

#### Competitor X Ref

|                        |                         |                   |                         |
|------------------------|-------------------------|-------------------|-------------------------|
| <b>Dunlop</b><br>DP410 | <b>Ferodo</b><br>FDB666 | <b>SBS</b><br>645 | <b>Vesrah</b><br>VD-251 |
|------------------------|-------------------------|-------------------|-------------------------|

#### MATERIAL AVAILABILITY AND PART NO.

| STD   | OPTIONS |   |     |     |
|-------|---------|---|-----|-----|
| FA    | HH      | R | MXS | GFA |
| FA160 | FA160HH | - | -   | -   |

# FA161 52.6 x 52.7 x 8mm

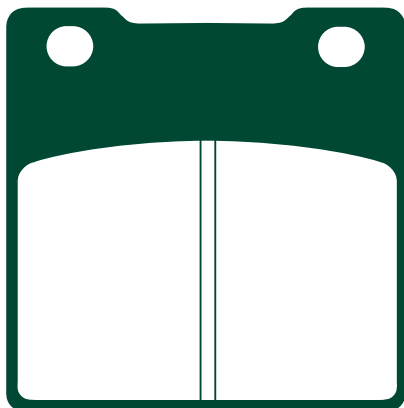

### KAWASAKI

Z 250 A1/A2/A3 78-81 R  
ZXR 400 (L1-L9) 91-03 R  
ZXR 400 H1/H2 89-90 R  
ZXR 400 J1/J2 89-90 R  
ZXR 400 R (ZX 400 M1-M4) 91-94 R  
ZXR 750 H1/H2/J1/J2/K1/K2/L1/L2 L3/M1/M2 89-95 R  
ZX-7R (ZX 750 P1/P2/P3/P4/P5/P6/P7) 96-03 R  
ZZR 1100 D1-D9 93-01 R  
ZRX 1100 (ZR 1100 C1/C2/C3/C4) 97-00 R  
ZX12R (ZX 1200 A1/A2/B1/B2) 00-03 R  
ZRX 1200 R(A1/A2/A3/A4/A5/A6F) 01-07 R  
ZRX 1200 5 (B1-B3) 01-04 R  
ZZR 1200 C1H/C2H 02-04 R  
ZX 12R (ZX 1200 B3/B4/B6F) 04-06 R

#### Competitor X Ref

|                        |                         |                   |                         |
|------------------------|-------------------------|-------------------|-------------------------|
| <b>Dunlop</b><br>DP318 | <b>Ferodo</b><br>FDB338 | <b>SBS</b><br>556 | <b>Vesrah</b><br>VD-416 |
|------------------------|-------------------------|-------------------|-------------------------|

#### Equivalents OE #

|            |            |            |
|------------|------------|------------|
| 43082 1003 | 43082 1141 | 43082 1257 |
| 43082 1098 | 43082 1180 | 43082 1291 |
| 43082 1103 | 43082 1200 |            |

#### MATERIAL AVAILABILITY AND PART NO.

| STD   | OPTIONS |   |     |     |
|-------|---------|---|-----|-----|
| FA    | HH      | R | MXS | GFA |
| FA161 | FA161HH | - | -   | -   |

# FA162 47.8 x 48.6 x 7.2mm

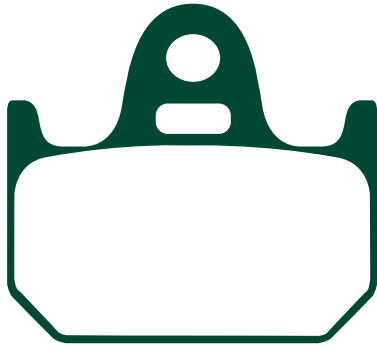

### YAMAHA

|                         |       |   |
|-------------------------|-------|---|
| TZ 125                  | 94-   | R |
| TZ 250                  | 89-   | R |
| TZ 250 (Radial caliper) | 03-05 | R |

### Equivalents OE #

|              |              |
|--------------|--------------|
| 3CL W0046 00 | 3LC W0046 00 |
| 3LC 25811 50 | 4TW W0046 00 |

### Competitor X Ref

| Dunlop | Ferodo  | SBS | Vesrah |
|--------|---------|-----|--------|
| -      | FDB2194 | 659 | -      |

### MATERIAL AVAILABILITY AND PART NO.

| STD   | OPTIONS |   |     |     |
|-------|---------|---|-----|-----|
| FA    | HH      | R | MXS | GFA |
| FA162 | -       | - | -   | -   |

# FA163 99.5 x 52 x 7.8mm

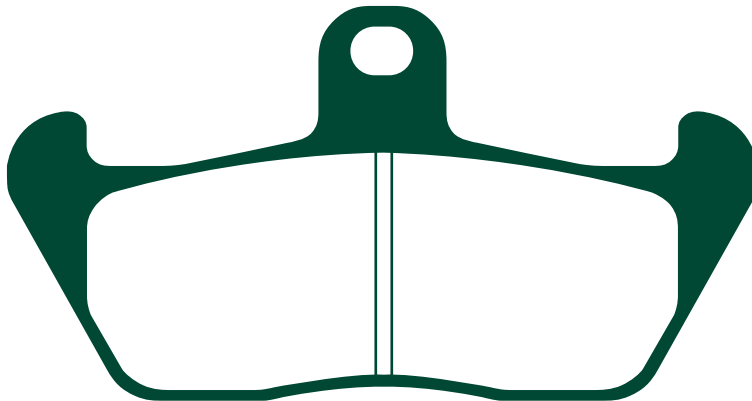

### CAGIVA

|                |       |   |
|----------------|-------|---|
| Mito 125       | 91-92 | F |
| W8 125         | 93-98 | F |
| Freccia 125 SY | 89    | F |
| Supercity 125  | 92-   | F |
| W12 "350"      | 93-95 | F |
| W16 "600"      | 94-98 | F |
| 750 Elefant    | 90-92 | R |

### APRILIA

|                  |    |   |
|------------------|----|---|
| Tuareg Rally 215 | 89 | F |
| Tuareg Wind 600  | 89 | F |

### GILERA

|               |     |   |
|---------------|-----|---|
| Nord-West 350 | 94- | F |
|---------------|-----|---|

### Equivalents OE #

|              |
|--------------|
| 8000 59214   |
| 000306546300 |
| 8113283      |

### Competitor X Ref

| Dunlop | Ferodo | SBS | Vesrah |
|--------|--------|-----|--------|
| DP618  | FDB529 | 641 | VD-927 |

### MATERIAL AVAILABILITY AND PART NO.

| STD   | OPTIONS |   |     |     |
|-------|---------|---|-----|-----|
| FA    | HH      | R | MXS | GFA |
| FA163 | -       | - | -   | -   |

# FA164 74.2 x 40.5 x 6.7mm

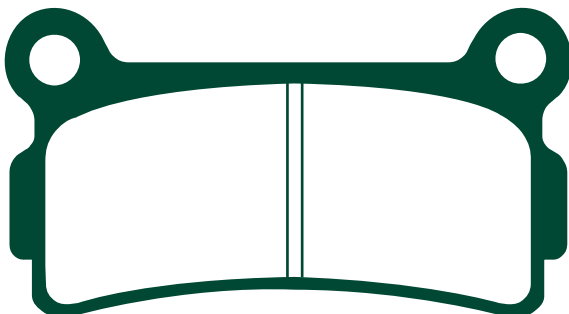

### BETA

|               |       |   |
|---------------|-------|---|
| TR34 260      | 89-91 | R |
| Synt          | 92    | R |
| Zero          | 92    | R |
| Supertrial ST | 94    | R |

### Equivalents OE #

|     |
|-----|
| N/A |
|-----|

### Competitor X Ref

| Dunlop | Ferodo | SBS | Vesrah |
|--------|--------|-----|--------|
| DP609  | -      | 636 | VD-938 |

### MATERIAL AVAILABILITY AND PART NO.

| STD   | OPTIONS |        |     |     |
|-------|---------|--------|-----|-----|
| FA    | HH      | R      | MXS | GFA |
| FA164 | -       | FA164R | -   | -   |

**FA165**      A. 96.7 x 42 x 7.4mm      B. 77.3 x 42 x 7.4mm

**FA165/2**      A. 96.7 x 42 x 9.7mm      B. 77.3 x 42 x 8mm

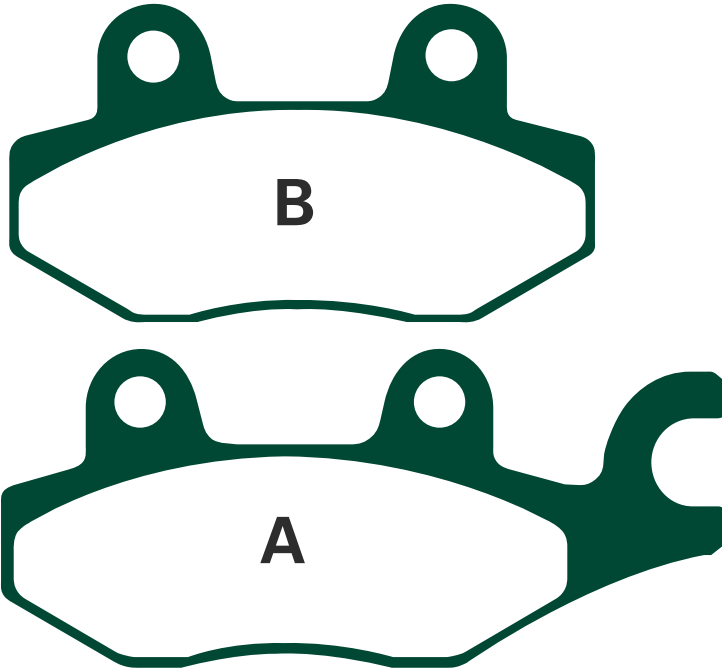

**FA165**

**AEON**

|                            |       |   |
|----------------------------|-------|---|
| Cobra RS 180 (Quad)        | 06    | R |
| Overland 125 (AT08) (Quad) | 02-06 | R |
| Overland 180 (AT08) (Quad) | 02-06 | R |

**BLANEY (Quads)**

|                |       |   |
|----------------|-------|---|
| XL 200 Trooper | 03-04 | R |
|----------------|-------|---|

**CPI**

|             |       |   |
|-------------|-------|---|
| XT 50 Quad  | 06    | R |
| XS 250 Quad | 06-07 | R |

**E-TON QUADS**

|                             |       |   |
|-----------------------------|-------|---|
| RXL 150 Viper R             | 05    | R |
| CXL 150 Yukon II/Challenger | 02-   | R |
| EXL 150 Eukon St            | 05-07 | R |
| RXL 150 Viper               | 05-06 | R |

**KAWASAKI**

|                                       |       |          |
|---------------------------------------|-------|----------|
| Kazer 115                             |       | F        |
| KLF 300 C1-C17 "Bayou"                | 89-05 | F(right) |
| KLF 400 B1-B7 Bayou                   | 93-99 | F(right) |
| KVF 750 A1/A6F/B1/B6F Brute Force 4x4 | 05-06 | F(right) |

**MBK**

|                   |    |   |
|-------------------|----|---|
| TZR 50 'X-Blazer' | 00 | F |
|-------------------|----|---|

**MODENAS**

|           |  |   |
|-----------|--|---|
| Kriss 115 |  | F |
|-----------|--|---|

**MOTO-ROMA**

|               |       |   |
|---------------|-------|---|
| Go-Go 110     | 02    | F |
| Geko 300 Quad | 04-06 | R |

**SUZUKI**

|                           |       |          |
|---------------------------|-------|----------|
| LT-F 300 FK2              | 02    | R(right) |
| LT-R 450 K6/K7            | 06-07 | F(right) |
| LTA 500 FY/FK1            | 00-01 | F(right) |
| LT-F 500 FW/FX/FY/FK1/FK2 | 98-02 | F(right) |

**TAISHAN**

|                    |    |   |
|--------------------|----|---|
| Panther 90 Quad    | 04 | R |
| Hurricane 125 Quad | 04 | R |
| Explorer 150 Quad  | 04 | R |
| Tornado 200 Quad   | 04 | R |

**YAMAHA**

|                                      |       |          |
|--------------------------------------|-------|----------|
| YFM 450 FXV Wolverine                | 06    | F(right) |
| YFZ 450 S/T/V/W                      | 04-07 | F(right) |
| YXR 66 FAS/FAT Rhino 4x4 Side x Side | 04-05 | F(right) |
| YFM 700 RV/RW Raptor                 | 06-07 | F(right) |
| XTZ 750 "Super Tenere"               | 89-95 | F(right) |

**FA165/2**

**BOMBARDIER**

|           |       |   |
|-----------|-------|---|
| Rally 200 | 05-06 | R |
|-----------|-------|---|

**CAGIVA**

|                           |       |   |
|---------------------------|-------|---|
| Canyon 600 E              | 96-99 | R |
| E 900 Elefant             | 90-92 | R |
| 900 IE Canyon/Gran Canyon | 97-00 | R |
| Canyon 500                | 96-00 | R |
| Navigator 1000            | 00-05 | R |

**MZ/MUZ**

|              |    |   |
|--------------|----|---|
| VRT 125 Quad | 05 | R |
| VRT 175 Quad | 05 | R |

**QUADZILLA**

|        |    |   |
|--------|----|---|
| WK 300 | 06 | R |
|--------|----|---|

**SUZUKI**

|           |    |   |
|-----------|----|---|
| DR 800 SM | 91 | R |
|-----------|----|---|

**YAMAHA**

|                        |       |   |
|------------------------|-------|---|
| XTZ 750 "Super Tenere" | 89-95 | R |
|------------------------|-------|---|

**VOXAN**

|                |       |   |
|----------------|-------|---|
| Scrambler 1000 | 02-05 | R |
|----------------|-------|---|

**Competitor X Ref**

| Dunlop | Ferodo | SBS | Vesrah |
|--------|--------|-----|--------|
| DP412  | FDB631 | 638 | VD-250 |

**Equivalents OE # - FA165**

|              |                 |
|--------------|-----------------|
| 43082 1094   | 7 020 016       |
| 3JD W0045 10 | IS3 W0046 10    |
| 59100 09840  | 59100 09860     |
| 59100 09850  | 810183          |
| 59100 39840  | 67131 BCAA 0000 |

**Equivalents OE # - FA165/2**

|              |                |
|--------------|----------------|
| 69100 31820  | 8000 66785     |
| 3LD W0046 01 | A45120 168 000 |

| MATERIAL AVAILABILITY AND PART NO. |         |        |        |     |
|------------------------------------|---------|--------|--------|-----|
| STD                                | OPTIONS |        |        |     |
| FA                                 | HH      | R      | MXS    | GFA |
| FA165TT                            | -       | FA165R | MXS165 | -   |

| MATERIAL AVAILABILITY AND PART NO. |         |          |     |     |
|------------------------------------|---------|----------|-----|-----|
| STD                                | OPTIONS |          |     |     |
| FA                                 | HH      | R        | MXS | GFA |
| FA165/2TT                          | -       | FA165/2R | -   | -   |



# FA166 100 x 46.7 x 7.5mm

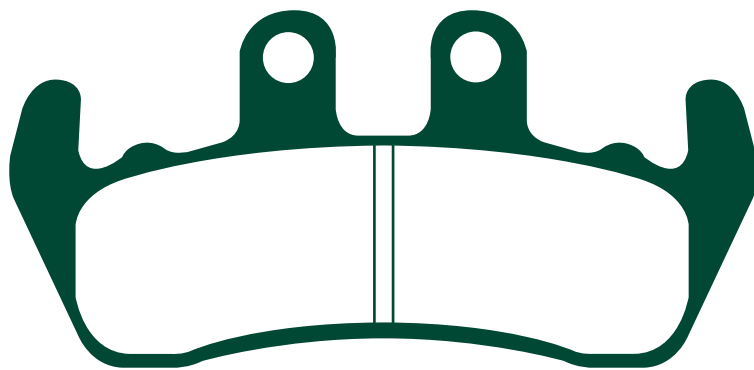

### HONDA HM (Italy)

CRE 50 Six/Baja/Derapage Grimeca  
caliper twin pin Kayaba forks 95-02 F

### YAMAHA

DT-Z 125 'Tenere/Tenere Scout' 89-90 F  
DT 125 Chesterfield Scout 89-90 F

Equivalents OE # K009463415

| MATERIAL AVAILABILITY AND PART NO. |         |   |     |     |
|------------------------------------|---------|---|-----|-----|
| STD                                | OPTIONS |   |     |     |
| FA                                 | HH      | R | MXS | GFA |
| FA166                              | -       | - | -   | -   |

### Competitor X Ref

| Dunlop | Ferodo | SBS | Vesrah |
|--------|--------|-----|--------|
| -      | -      | -   | -      |

# FA167 77 x 42 x 7.5mm

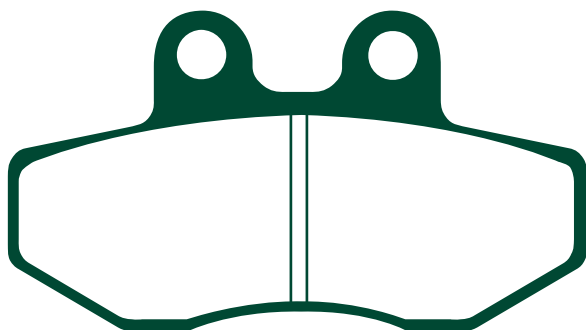

### AJP

PR4-Enduro 125/200 04-07 F  
PR4-Supermotard 125/200 04-07 F

### APRILIA

RX 50 06-07 F  
SX 50 06-07 F  
RX3-5 Marce (M/N/P/R) 91-94 F  
Tuareg Rally 125 (N) 93 F  
Pegaso 125 91 F  
Pegaso 600 91 F  
Classic 125 99 F

### BETA

RK6 93-96 F  
RK6 50cc Enduro 97-02 F  
RR Enduro Alu 50/Motard Alu 50/Enduro 50 04-07 F

### CH RACING

WXE 50 Enduro 05 F  
WSM 50 Motard 05 F  
WXE 125 Enduro 05 F  
WSM 125 Motard 05 F

### DERBI

GPR 50-R/Replica 98-03 F  
Senda R DRD 04-05 F  
Senda 50 DRD Racing R Enduro 04-07 F  
Senda 50 DRD Racing SM Supermoto 04-07 F  
SM 50 DRD Edition 05 F

### Competitor X Ref

| Dunlop | Ferodo | SBS | Vesrah |
|--------|--------|-----|--------|
| DP613  | FDB706 | 652 | -      |

| MATERIAL AVAILABILITY AND PART NO. |         |   |     |     |
|------------------------------------|---------|---|-----|-----|
| STD                                | OPTIONS |   |     |     |
| FA                                 | HH      | R | MXS | GFA |
| FA167                              | FA167HH | - | -   | -   |

### EXPLORER

KBR 200 05 F

### GAS-GAS

EC 50 Rookie 01-04 F  
SM 50 Rookie 01-04 F

### HRD

Cabriolet 125 01 F  
Sonic 2 Trail 50 F  
Sonic 2 Supermotard 50 F  
Cabriolett Trail 125 F  
Cabriolett Supermotard 125 F

### HUSQVARNA

SM 50 02 F  
WR 50 02 F  
WXE 125 07 F

### MH (MOTORHISPANIA)

RX 50 Super Racing 00-07 F  
Furia Max Supermotard 05-07 F  
RYZ 50 Pro Racing Enduro 06-07 F  
RYZ 50 Racing Super Motard 06-07 F  
RYZ 50 Pro Racing Urban Bike 06-07 F  
Arena 125 Pro Racing Supermotard 06-07 F  
Arena 125 Pro Racing Urban Bike 06-07 F  
RYZ 50 Urban Bike 06-07 F  
RYZ 50 Supermotard 06-07 F

### MOTO ROMA

SMX 125 04-06 F

### PEUGEOT

XR 6 50cc 02-07 F  
xps sTREET 50 05-07 F  
XP 125 Street Evo 2 05 F

### RIEJU

RR 50 Castrol 50 00-02 F  
RS1 50cc 01-04 F  
MRX 50 Castrol/SMX 50 01-02 F  
Spike 50 Pro 04 F  
SMX 125 02-07 F  
MRX 125 02-07 F

### SACHS

Roadster 125 00-03 F

### SHERCO

SM 50 Supermotard 03-07 F  
Enduro 50 (50 EN) 03-07 F  
SM 125/125 City Corp 03-06 F

### TOMOS

SE 50/125 05 F

### Equivalents OE #

|                       |                |
|-----------------------|----------------|
| 8113373               | 214 007 100002 |
| 8113478               | 00009300065    |
| 8113604               | DORTS01A0015   |
| 00H 0470 2141         | 2525230000     |
| P00 927 020 64 07 000 |                |

# FA168 Use FA252

# FA169 61.1 x 27.1 x 7.3mm

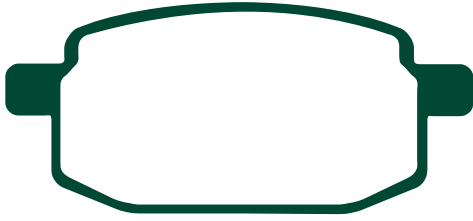

**ADLY**

|                       |       |   |
|-----------------------|-------|---|
| City Bird             |       | F |
| Fox 50                |       | F |
| Road Tracer 50/90/100 | 04-06 | F |

**DAELIM**

|                     |    |   |
|---------------------|----|---|
| M 50 D/MD Millenium | 03 | F |
| DX 50 D Camper      | 03 | F |
| ST 90 Pro Monkey    | 03 | F |

**FYM/X-Sport**

|                          |       |   |
|--------------------------|-------|---|
| CR 90 E                  | 06-07 | F |
| 110 ES                   | 06-07 | F |
| CR 110                   | 06-07 | F |
| CR 110 ESR               | 06-07 | F |
| X-Sport Typhoon 125 Quad | 06-07 | F |
| CR 3 125                 | 06-07 | F |
| CR 125 R                 | 06-07 | F |

**GARELLI**

|               |    |   |
|---------------|----|---|
| FX 50         |    | F |
| Cpri 50/LX 50 | 07 | F |
| Ciclone 50    | 07 | F |

**HERO**

|            |    |   |
|------------|----|---|
| Nipster 50 | 06 | F |
|------------|----|---|

**JORDAN**

|             |       |   |
|-------------|-------|---|
| Easy 50/100 | 03-04 | F |
|-------------|-------|---|

**KAWARA**

|             |    |   |
|-------------|----|---|
| Fever 50/90 | 99 | F |
| Stinger 90  | 99 | F |

**LIFAN**

|           |  |   |
|-----------|--|---|
| LF 50 QGY |  | F |
|-----------|--|---|

**MOTO-ROMA**

|                    |       |   |
|--------------------|-------|---|
| Bee 50             | 04-05 | F |
| Go-Go 50/110       | 97-05 | F |
| Stinger 50         | 01-05 | F |
| Scrambler 50       | 01    | F |
| Road Runner 50/100 | 01-02 | F |
| Grand Prix 125     | 01    | F |

**MBK**

|                        |       |   |
|------------------------|-------|---|
| CY 50 Forte/Forte Mufa | 96-97 | F |
| CR 50 Z Target         | 91-95 | F |

**MZ/MUZ**

|                 |       |   |
|-----------------|-------|---|
| Moskito FB50    | 97-03 | F |
| Moskito SX/JP50 | 00-03 | F |

**P.G.O**

|                |       |   |
|----------------|-------|---|
| Big Max 50/90  | 94-06 | F |
| EPS            | 97    | F |
| Tornado 50/125 | 97    | F |

**QUADZILLA**

|                     |       |   |
|---------------------|-------|---|
| WK 110              | 05-06 | F |
| WK 125 (All models) | 06    | F |

**SIAMOTO**

|           |       |   |
|-----------|-------|---|
| Birdie 50 | 02-04 | F |
| Favorite  | 02-04 | F |

**SUPERBYKE**

|                       |  |   |
|-----------------------|--|---|
| M-Ped 50 Road Classic |  | F |
|-----------------------|--|---|

**TERRA MOTO**

|                       |    |     |
|-----------------------|----|-----|
| TDX 125 F             | 07 | F&R |
| TDX 125 F Krusha      | 07 | F&R |
| TDX 125 F Street Ripa | 07 | F&R |

**THUMPSTAR**

|                           |       |     |
|---------------------------|-------|-----|
| Thumpstar Junior 90cc     | 04-06 | F   |
| Thumpstar Supa 110cc      | 04-06 | F   |
| Thumpstar Expert 125      | 06    | F   |
| Thumpstar Pro 125         | 05-06 | F   |
| Thumpstar 125 Road Ripper | 06    | F&R |

**VIALLI**

|              |    |   |
|--------------|----|---|
| Cargo 50     | 06 | F |
| FXR Sport 50 | 06 | F |
| Jupiter 50   | 06 | F |

**WUYANG**

|          |       |   |
|----------|-------|---|
| WY 50 QT | 06-07 | F |
|----------|-------|---|

**YAMAHA**

|                       |       |   |
|-----------------------|-------|---|
| CR-Z 50 (3WN)         | 91-95 | F |
| CY 50 RS Jog R        | 96-   | F |
| YA 50 ZA Jog Z (4SC1) | 95    | F |
| YW 100 T Booster BWs  | 96    | F |

**Equivalents OE #**

|               |              |
|---------------|--------------|
| 2NA W0045 01  | 5JU W0045 00 |
| 5CP W0045 00  | 802 567 1000 |
| 45120 107 000 | T01H000101   |
| 3XG W0045 00  |              |

**Competitor X Ref**

|               |               |            |               |
|---------------|---------------|------------|---------------|
| <b>Dunlop</b> | <b>Ferodo</b> | <b>SBS</b> | <b>Vesrah</b> |
| N/A           | FDB636        | 619        | VD253         |

| MATERIAL AVAILABILITY AND PART NO. |         |   |     |     |
|------------------------------------|---------|---|-----|-----|
| STD                                | OPTIONS |   |     |     |
| FA                                 | HH      | R | MXS | GFA |
| FA169                              | FA169HH | - | -   | -   |

# FA170 99.8 x 55.8 x 9.3mm

**USE  
FA246**

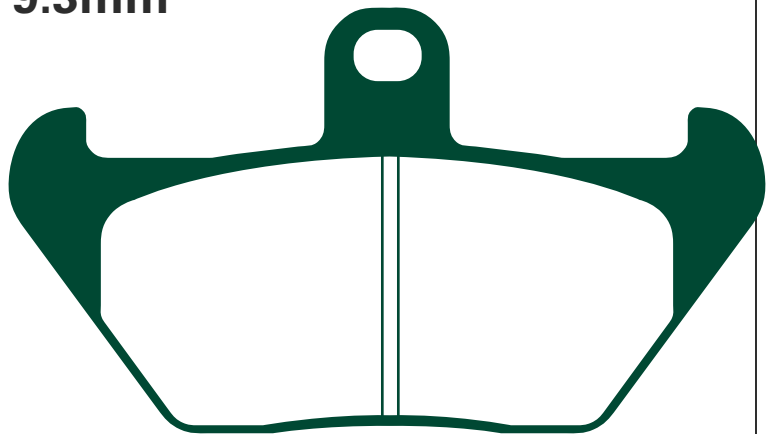

# FA171 57.7 x 53.7 x 8.9mm

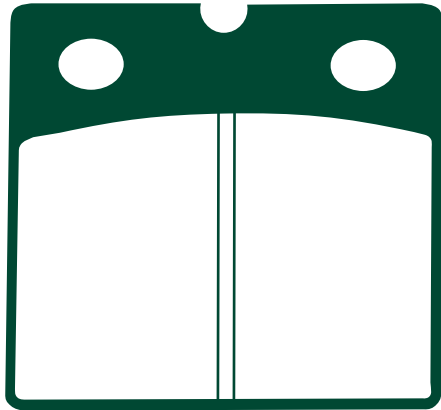

### BMW

|              |             |   |
|--------------|-------------|---|
| K 75/75-2    | 09/88-96    | F |
| K 75/75-S    | 08/90-96    | F |
| K 75 C       | 09/88-02/88 | F |
| K 75 RT      | 89-96       | F |
| K 75 RT      | 89-96       | F |
| K 75 S       | 09/88-95    | F |
| K 75 S       | 09/88-95    | F |
| K 100/2      | 09/88-90    | F |
| K 100 LT     | 09/88-91    | F |
| K 100 RS     | 10/88-89    | F |
| K 100 RT     | 10/88-89    | F |
| R 80/R 80 RT | 09/88-95    | F |
| R 100 RS     | 9/9-92      | F |
| R 100 RT     | 09/88-95    | F |

### Competitor X Ref

| Dunlop | Ferodo | SBS | Vesrah |
|--------|--------|-----|--------|
| DP608  | FDB736 | 640 | VD-933 |

### Equivalents OE #

|                 |                 |
|-----------------|-----------------|
| 34 11 2 310 494 | 34 11 2 331 175 |
| 34 11 2 311 175 | 34 11 2 314 546 |

### MATERIAL AVAILABILITY AND PART NO.

| STD   | OPTIONS |   |     |     |
|-------|---------|---|-----|-----|
| FA    | HH      | R | MXS | GFA |
| FA171 | FA171HH | - | -   | -   |

# FA172 A. 104 x 45.6 x 9.8mm B. 88 x 42 x 9.8mm

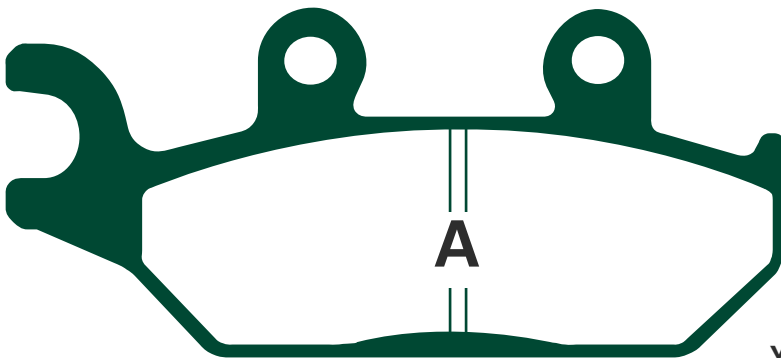

A

### YAMAHA

|                  |       |   |
|------------------|-------|---|
| XT 600 E         | 92-03 | F |
| XTZ 660 "Tenere" | 91-98 | F |

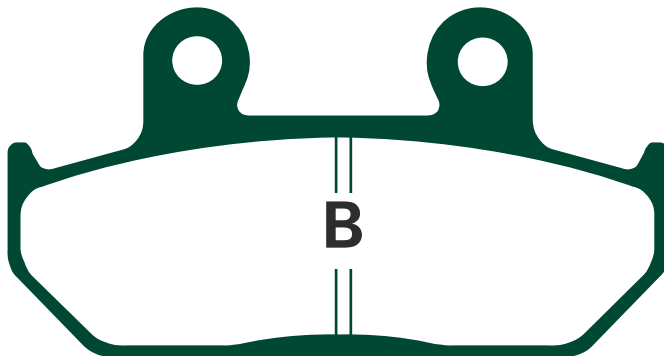

B

### Equivalents OE #

|              |              |
|--------------|--------------|
| 3YF W0045 00 | 4PT W0045 00 |
| 3TB W0045 00 |              |

### Competitor X Ref

| Dunlop | Ferodo | SBS | Vesrah |
|--------|--------|-----|--------|
| DP413  | FDB737 | 650 | VD-252 |

### MATERIAL AVAILABILITY AND PART NO.

| STD     | OPTIONS |        |     |     |
|---------|---------|--------|-----|-----|
| FA      | HH      | R      | MXS | GFA |
| FA172TT | -       | FA172R | -   | -   |

# FA173 A. 85 x 42.5 x 7.3mm

# B. 56 x 35 x 9.7mm

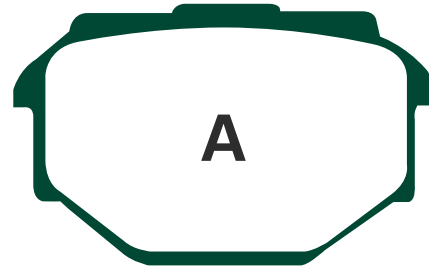
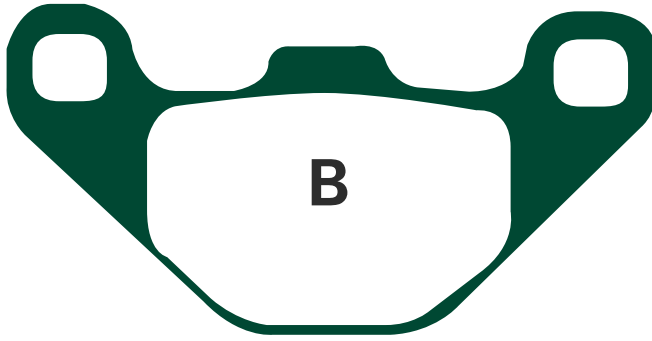

### APRILIA

|            |       |   |
|------------|-------|---|
| ETX 125    | 99-01 | R |
| Moto 6.5   | 95-01 | R |
| Pegaso 650 | 91-00 | R |

### BETA

|              |       |   |
|--------------|-------|---|
| Jonathan 125 | 02-05 | R |
|--------------|-------|---|

### CAGIVA

|           |       |   |
|-----------|-------|---|
| W12 "350" | 93-95 | R |
| W16 "600" | 94-98 | R |

### GILERA

|                 |     |     |
|-----------------|-----|-----|
| Eaglet 50       | 96  | R   |
| 50 RC Top Rally | 90- | F&R |

### MALAGUTI

|             |       |   |
|-------------|-------|---|
| F10 Jetline | 91-93 | F |
| 50 America  | 91-   | F |

### MBK

|            |    |   |
|------------|----|---|
| X-Limit 50 | 02 | R |
|------------|----|---|

### MZ/MUZ

|                              |       |   |
|------------------------------|-------|---|
| Baghira/Mastiff (All models) | 00-05 | R |
|------------------------------|-------|---|

### YAMAHA

|                    |       |   |
|--------------------|-------|---|
| TDR 125 (3HS/3XD1) | 89-93 | R |
|--------------------|-------|---|

### Equivalents OE #

|                 |              |
|-----------------|--------------|
| 34 11 2 310 494 | 902203100    |
| 8113595         | 3SH F5811 00 |
| 8000 68794      | 5VB W0045 00 |
| 11940100        |              |

### Competitor X Ref

| Dunlop | Ferodo | SBS | Vesrah |
|--------|--------|-----|--------|
| DP310  | FDB828 | 684 | VD-425 |

### MATERIAL AVAILABILITY AND PART NO.

| STD   | OPTIONS |   |     |     |
|-------|---------|---|-----|-----|
|       | HH      | R | MXS | GFA |
| FA173 | -       | - | -   | -   |

# FA174 86.3 x 41.4 x 10.2mm



### Competitor X Ref

| Dunlop | Ferodo | SBS | Vesrah |
|--------|--------|-----|--------|
| DP121  | FDB754 | 670 | VD-162 |

### Equivalents OE #

|               |               |              |
|---------------|---------------|--------------|
| 43105 MW0 405 | 69100 06830   | 5VX W0045 00 |
| T2020602      | 06435 MEE 006 | 43020 S020   |
| 5SL W0046 00  | 69100 06820   |              |
| 06435 KV3 405 | 06435 MEJ 006 |              |

### HONDA

|   |       |   |
|---|-------|---|
| CB 400 SF4/5/S5                                     | 04-05 | R |
| CB 400 SBS  | 05    | R |
| VRX 400 T (NC33)                                    | 96    | R |
| CB 500 A4/A5/A6/A7                                  | 04-07 | R |
| CBF 500 4 (Non ABS Model)                           | 04-   | R |
| CB 600 FW/FX/ "Hornet"                              | 98-00 | R |
| CB 600 FY/F2Y/F1/F21/F22/F22/F3/F4/F5/F6/AF7 Hornet | 00-07 | R |
| CBF 600 N4/NA4/S4/SA4/N5/NA5/S5/SA5                 | 04-05 | R |
| CBF 600 NA4/NA5/NA6 (ABS Model)                     | 04-06 | R |
| CBF 600 N7 (Radial caliper)                         | 07    | R |
| CBF 600 S4/S5 (Non ABS)                             | 04-05 | R |
| CBF 600 SA4/SA5/SA6 (ABS Model)                     | 04-06 | R |
| CBR 600 FM/FN/FP/FR/FS/FT/FV/FW/FX/FY               | 91-00 | R |
| CBR 600 F1/F2/600 FS1/FS2 'Sport'                   | 01-02 | R |
| CBR 600 F3/F4/F5/F6/F7                              | 03-07 | R |
| CBR 600 RR3/RR4/RR5/RR6                             | 03-06 | R |
| CB 750 F2N/F2R/F2S/F2T/F2V/F2W/F2X/F2Y/F2Z          |       |   |
| CB Seven Fifty                                      | 92-02 | R |
| CBR 900 RRN/RRP/RRR/RRS/RRT/RRV                     |       |   |
| /RRW/RRX/RRY/RR1/RR2/RR3 Fireblade                  | 92-03 | R |
| CB 900 F2/F3/F4/F5/F6/F7 Hornet                     | 02-07 | R |
| CB 1000 FP/FR/FS/FT/FV                              | 93-97 | R |
| CBF 1000 F6/F7                                      | 06-07 | F |
| CBR 1000 RR4/RR5 Fireblade                          | 04-05 | R |
| VTR 1000 FV/FW/FX/FY/F1/F2/F3/F4/F5/F6 'Firestorm'  | 97-06 | R |
| VT-R 1000 SPY/SP1 (SC45)                            | 00-01 | R |
| VTR 1000 SP2/SP3/SP4/SP5/SP6                        | 02-07 | R |
| VT 1100 C4 Shadow Sabre                             | 04-05 | R |
| CB 1300 F3/F13                                      | 03-04 | R |
| CB 1300 5/6 (Superfour)                             | 05-06 | R |
| CB 1300 A5/A6 (Superfour ABS)                       | 05-06 | R |
| CB 1300 SA5/SA6 Super Bol-Dor                       | 05-06 | R |
| VTX 1300 S3/S4/S5/S6/S7                             | 03-07 | R |

### KAWASAKI

|                            |       |   |
|----------------------------|-------|---|
| Z 750 (ZR 750 L7F)         | 07    | R |
| Z 750 ABS (ZR 750 M7F)     | 07    | R |
| KLX 1000 (LV 1000 A1H/A2H) | 04-05 | R |
| Z 1000 (ZR 1000 B7F)       | 07    | R |
| Z 1000 ABS (ZR 1000 C7F)   | 07    | R |

### SUZUKI

|   |       |   |
|---|-------|---|
| DL 650 K4/K5/K6 V-Strom                   | 04-06 | R |
| DL 650 K7                                 | 07    | R |
| DL 650 AK7 V-Strom ABS                    | 07    | R |
| GSF 650 K6/SAK6/K7/SAK7 (Bandit ABS)      | 06-07 | R |
| SV 650 K3/SK3/K4/SK4/K5/SK5/K6/SK6/SK7/K7 | 03-07 | R |
| SV 650 AK7/SAK7 ABS Model                 | 07    | R |
| DL 1000 K2/K3/K4/K5/K6/K7 V-Strom         | 02-07 | R |
| SV 1000 K3/SK3/K4/SK4/K5/SK5/SK6          | 03-06 | R |
| GSF 1200 AK6/SAK6/GTSAK6                  | 06    | R |
| GSF 1250 AK7/ASK7 Bandit                  | 07    | R |

### YAMAHA

|                                       |       |   |
|---------------------------------------|-------|---|
| YZF-R6                                | 03-07 | R |
| YZF-R6S                               | 07    | R |
| FZ6 Fazer/Fazer A                     | 04-07 | R |
| FZ6 (Naked version)                   | 04-07 | R |
| FZ6 S2 ABS (Naked)                    | 07    | R |
| FZ6 Fazer S2 (ABS) (4 piston caliper) | 07    | R |
| YZF 100 R1                            | 04-06 | R |
| FZ1-N/NV (Naked) (1000cc) (2D11/2/3)  | 06-07 | R |
| FZ1-S/FZ1-SV                          | 06-07 | R |
| YZF-R1SP                              | 06    | R |
| YZF R1 (6 piston radial caliper)      | 07    | R |

### MATERIAL AVAILABILITY AND PART NO.

| STD   | OPTIONS |   |     |     |
|-------|---------|---|-----|-----|
|       | HH      | R | MXS | GFA |
| FA174 | FA174HH | - | -   | -   |

# FA175 33.7 x 50.5 x 7mm

## CFK175

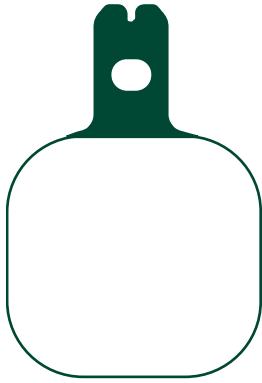

### Equivalents OE #

|         |
|---------|
| 29-001  |
| 1296033 |

### HARRISON BILLET

4/6 Piston Caliper Lightweight Mini Design

### ISR CALIPERS

|                          |   |
|--------------------------|---|
| 22-032 (6 piston large)  | F |
| 22-042 (6 piston racing) | F |

### Competitor X Ref

| Dunlop | Ferodo | SBS | Vesrah |
|--------|--------|-----|--------|
| -      | FRP415 | 656 | -      |

### MATERIAL AVAILABILITY AND PART NO.

| STD            | OPTIONS |   |     |          |
|----------------|---------|---|-----|----------|
| FA             | HH      | R | MXS | GFA      |
| FA175          | FA175HH | - | -   | GFA175HH |
| CFK175 (Blue)  |         |   |     |          |
| FA175S (Green) |         |   |     |          |

# FA176 87 x 53 x 7.5mm



### HONDA

|                      |       |   |
|----------------------|-------|---|
| NH 50 Lead 50 SS     | 84    | F |
| NH 50 Lead AF01/d716 | 84-85 | F |
| NH 80 Lead 80/SS     | 85    | F |
| NH 125 Lead 125      | 86-87 | F |

### Equivalents OE #

|  |
|--|
|  |
|--|

### Competitor X Ref

| Dunlop | Ferodo | SBS | Vesrah |
|--------|--------|-----|--------|
| -      | -      | -   | VD137  |

### MATERIAL AVAILABILITY AND PART NO.

| STD   | OPTIONS |   |     |     |
|-------|---------|---|-----|-----|
| FA    | HH      | R | MXS | GFA |
| FA176 | -       | - | -   | -   |

# FA177 87 x 53 x 7.5mm

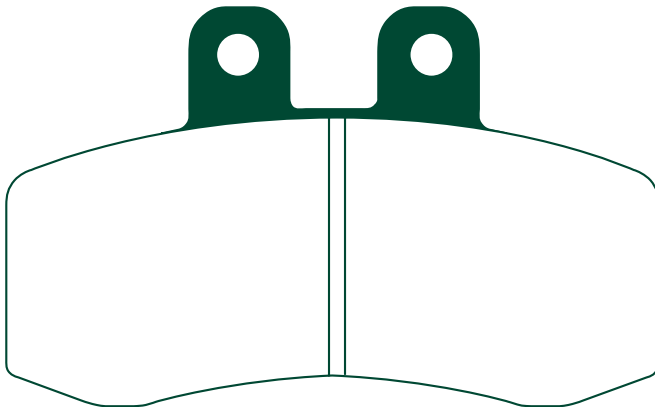

### APRILIA

|            |       |   |
|------------|-------|---|
| Pegaso 650 | 91-96 | F |
|------------|-------|---|

### MZ/MUZ

|                              |       |   |
|------------------------------|-------|---|
| Baghira/Mastiff (All models) | 00-05 | F |
| 660 Supermoto                | 06-07 | F |

### Equivalents OE #

|            |
|------------|
| 9022001000 |
|------------|

### Competitor X Ref

| Dunlop | Ferodo | SBS | Vesrah |
|--------|--------|-----|--------|
| DP615  | FDB782 | 681 | -      |

### MATERIAL AVAILABILITY AND PART NO.

| STD   | OPTIONS |   |     |     |
|-------|---------|---|-----|-----|
| FA    | HH      | R | MXS | GFA |
| FA177 | -       | - | -   | -   |

# FA178 41.1 x 43 x 7.7mm



| MATERIAL AVAILABILITY AND PART NO. |         |   |     |     |
|------------------------------------|---------|---|-----|-----|
| STD                                | OPTIONS |   |     |     |
| FA                                 | HH      | R | MXS | GFA |
| FA178                              | -       | - | -   | -   |

**Competitor X Ref**

| Dunlop | Ferodo | SBS | Vesrah |
|--------|--------|-----|--------|
| DP903  | -      | 670 | VD-162 |

# FA179 102 x 41 x 10mm

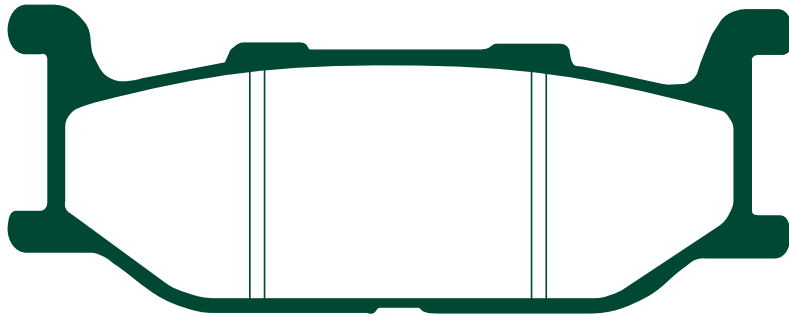

**Equivalents OE #**

|              |              |
|--------------|--------------|
| 3YX W0045 00 | 4TR W0045 00 |
| 4BP W0045 00 | 4WM W0045 00 |
| 4FU W0045 00 | 5BN W0045 00 |
| 4KM W0045 00 | 5RU W0045 00 |

**Competitor X Ref**

| Dunlop | Ferodo | SBS | Vesrah |
|--------|--------|-----|--------|
| DP414  | FDB781 | 663 | VD-255 |

**YAMAHA**

|  |       |   |
|--|-------|---|
| CP 250 (EB71) Maxam                      | 05    | F |
| FZX 250 Zeal (3YX1/2/4)                  | 91-92 | F |
| SRV 250 'Soulful twin/Renaissa' (4DN1-6) | 92-97 | F |
| SR 400 (BC-RU01J)                        |       | F |
| XVS 400                                  | 96    | F |
| YP 400 S Majesty (5RU1/3)                | 04    | F |
| XP 500 N/P/R T-Max                       | 01-03 | F |
| XV 535/535 S 'Virago'                    | 95-03 | F |
| XJ 600 N                                 | 95-97 | F |
| XJ 600 S "Diversion"                     | 92-97 | F |
| XVS 650 Drag Star                        | 97-04 | F |
| XVS 650 A Dragstar classic               | 98-07 | F |
| XV 750 Virago                            | 94-97 | F |
| XJ 900 S "Diversion"                     | 95-03 | F |
| XV 1100 Virago                           | 94-98 | F |
| XVZ 1300 TF 'Venture Star'               | 99-01 | F |
| XV 1600 A 'Wildstar'                     | 99-04 | F |

**MATERIAL AVAILABILITY AND PART NO.**

| STD   | OPTIONS |   |     |     |
|-------|---------|---|-----|-----|
| FA    | HH      | R | MXS | GFA |
| FA179 | FA179HH | - | -   | -   |

# FA180 58.9 x 40 x 8mm

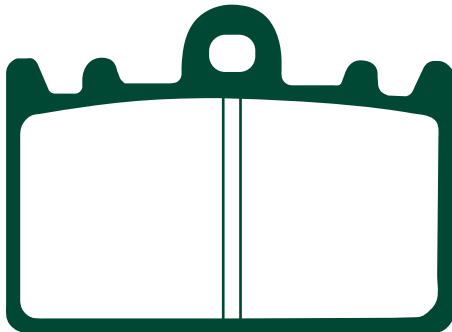

**KAWASAKI**

ZXR 400 L1-L9 91-03 F

**SUZUKI**

RGV 250 T (RGVR 250 SP VJ23A) 96 F

**AFTERMARKET CALIPERS**

PRE-TECH - 4 piston (UNI P401) F

**Equivalents OE #**

|             |
|-------------|
| 43082 1130  |
| 59300 42840 |

**Competitor X Ref**

| Dunlop | Ferodo | SBS | Vesrah |
|--------|--------|-----|--------|
| DP319  | FDB741 | 666 | VD-433 |

**MATERIAL AVAILABILITY AND PART NO.**

| STD   | OPTIONS |   |     |          |
|-------|---------|---|-----|----------|
| FA    | HH      | R | MXS | GFA      |
| FA180 | FA180HH | - | -   | GFA180HH |

# FA181 94 x 37.3 x 7.5mm



1 Left/1 Right

|                                |             |     |  |                                       |       |     |   |
|--------------------------------|-------------|-----|--|---------------------------------------|-------|-----|---|
| <b>APRILIA</b>                 |             |     |  | <b>KTM</b>                            |       |     |   |
| RX 125                         | 00-01       | F   |  | LC2 125                               | 96-98 | F   |   |
| MX 125                         | 04-06       | F   |  | MX 125                                | 92-93 | F   | F |
| SXV 4.5 Supermoto              | 04          | F   |  | D-XC/E-XC/E-GS 125                    | 92-93 | F   | F |
| <b>BENELLI</b>                 |             |     |  | EXC/EGS 125                           | 94    | F   | F |
| BX 450                         | 07          | F   |  | EXC 125                               | 95-07 | F   | F |
| <b>CAGIVA</b>                  |             |     |  | EXC 200/EGS                           | 94-07 | F   | F |
| E 900 Elefant                  | 93-97       | F&R |  | SM 125 Supermoto                      | 00    | F   | F |
| E 750 Elefant                  | 93-95       | R   |  | EXE 125                               | 00    | F   | F |
| <b>CCM</b>                     |             |     |  | EXC 200                               | 04-07 | F   | F |
| R30 (Spoke & Mag Wheel)        | 02-04       | F   |  | EXC 250 Racing                        | 06    | F   | F |
| R35/R 35 S                     | 06          | F   |  | EXC-F 250                             | 06-07 | F   | F |
| 404E                           | 03-04       | F   |  | EXC 300 (Upside Down Forks)           | 00-07 | F   | F |
| 404 DS                         | 03-04       | F   |  | MX 250                                | 92-93 | F   | F |
| 404 DS Supermoto               | 03-04       | F   |  | SX 250                                | 94-07 | F   | F |
| 604E Supermotard/RS/Dual Sport | 98-03       | F   |  | SX-F 250                              | 06-07 | F   | F |
| 644 DS Supermoto               | 04          | F   |  | EXC/EGS 250                           | 94    | F   | F |
| 644 DS                         | 04          | F   |  | EXC 250                               | 95-05 | F   | F |
| <b>DUCATI</b>                  |             |     |  | EXC 350 LC4                           | 94-95 | F   | F |
| Monster S2R (803cc)            | 05          | F   |  | SX 360                                | 96-97 | F   | F |
| Multistrada 620                | 05-06       | F   |  | EXC 360                               | 96-97 | F   | F |
| Monster Dark 620               | 05-06       | F   |  | SX 380                                | 98-03 | F   | F |
| Monster 620                    | 05-06       | F   |  | EXC 380                               | 98-03 | F   | F |
| 695 Monster                    | 06-07       | F   |  | EXC 400 Racing                        | 06-07 | F   | F |
| S2R Dark (803cc)               | 06          | F   |  | EXC 450 Racing                        | 06-07 | F   | F |
| Paul Smart 1000 Limited        | 06          | F   |  | XC 525 Racing                         | 06-07 | F   | F |
| GT 1000 Sport (992cc)          | 06          | F   |  | SC 400                                | 96-99 | F   | F |
| Classic Sport Biposto (992cc)  | 07          | F   |  | EGS/EGS-E/LSE 400 (LC4 Enduro)        | 96-99 | F   | F |
| Sport 1000 S (992cc)           | 07          | F   |  | SX 400                                | 00-02 | F   | F |
| <b>FACTORY</b>                 |             |     |  | EXC/EGS 400 (USD)                     | 00-02 | F   | F |
| YR 250                         | 03          | R   |  | EXC 400 Racing (USD)                  | 00    | F   | F |
| <b>GAS GAS</b>                 |             |     |  | LC4-E 400 Enduro                      | 00-01 | F   | F |
| Quad Wild HP 50                | 04-07       | F&R |  | SX 440                                | 94-95 | F   | F |
| 80/125 Enduro                  | 94-95       | F   |  | EXC 440                               | 94-95 | F   | F |
| MX 80                          | 96          | F   |  | SX-F 450 (USD)                        | 03-07 | F   | F |
| 80/125/250/200/300 Enduro      | 95-99       | F   |  | EXC 450                               | 03-05 | F   | F |
| Enduro EC 125/200/250/300      | 97-99       | F   |  | MX 500                                | 92-95 | F   | F |
| MX 200/250/300                 | 99-00       | F   |  | SX-F 505                              | 07    | F   | F |
| Wild HP 240/300                | 03-06       | F&R |  | SX 520                                | 01-03 | F   | F |
| Pampera 400                    | 06          | F   |  | EXC 520                               | 01-03 | F   | F |
| Wild HP 450 Quad               | 04-07       | F&R |  | EXC 525                               | 03    | F   | F |
| <b>GILERA</b>                  |             |     |  | SX 525                                | 03-06 | F   | F |
| Nexus 500                      | 03-07       | F   |  | EXC 525                               | 04-05 | F   | F |
| GP 800                         | 07          | F   |  | MXC 525                               | 03-04 | F   | F |
| <b>HIGHLAND</b>                |             |     |  | XC 525 Racing                         | 06-07 | F   | F |
| 950 V2 Outback                 | 00-04       | F   |  | MXC 550                               | 96    | F   | F |
| 950 V2 Motard                  | 00-04       | F   |  | SX/EXC/EGS 620                        | 94-95 | F   | F |
| <b>HONDA HM (Italy)</b>        |             |     |  | SX 620                                | 96-98 | F   | F |
| CRE 50 Six                     | 01-02       | F   |  | SC 620 Supercompetition               | 96-00 | R   | F |
| CRE 50 Baja/Derapage           | 01-02       | F   |  | EGS/EGS-E/LSE 620 Enduro              | 96-99 | F   | F |
| <b>HUSABERG</b>                |             |     |  | EGS-E 620 Adventure/Rallye            | 99    | F   | F |
| Enforcer Four                  | 00-03       | F&R |  | LC4 620 SC Supermoto                  | 00    | F   | F |
| FE 450 E                       | 06-07       | F   |  | SXC 625                               | 05-06 | F   | F |
| FE 550 E                       | 06-07       | F   |  | LC4-E 640 Enduro                      | 00-04 | F   | F |
| FE 650 E                       | 06-07       | F   |  | LC4-E 640 Supermoto                   | 00-06 | F   | F |
| <b>HUSQVARNA</b>               |             |     |  | LC4 640 Adventure R                   | 00    | F   | F |
| CR 125                         | 95-07       | F   |  | 640 LC4 Adventure                     | 03-07 | F   | F |
| SM 125                         | 98-00       | F   |  | LC4 625 SC Supermoto                  | 02    | F   | F |
| SM 125 S                       | 02-07       | F   |  | LC4 625 SC Supercompetition           | 02    | F   | F |
| WR 125                         | 05-07       | F   |  | SXC 625                               | 03-04 | F   | F |
| WRE 125                        | 93-00       | F   |  | LC4 640 Adventure                     | 01-06 | F   | F |
| CR 250                         | 95-05       | F   |  | SM 950                                | 05-06 | R   | F |
| TC 250                         | 02-03/05-07 | F   |  | 950 R Superenduro                     | 06    | R   | F |
| TE 250                         | 02-07       | F   |  | 990 Adventure/S                       | 06-07 | R   | F |
| WR 250                         | 95-07       | F   |  | <b>MAICO</b>                          |       |     |   |
| TE 350                         | 95-97       | F   |  | 500 MX/Enduro                         | 99    | F   |   |
| WR 360                         | 95-02       | F   |  | <b>MBK</b>                            |       |     |   |
| TE 400                         | 02          | F   |  | XQ 125/150 Thunder                    | 01-03 | F   | F |
| TE 410                         | 95-00/06    | F   |  | YP 125 D Skyliner                     | 98-06 | F   | F |
| TE 410 E                       | 00          | F   |  | VP 300 R Kilibre                      | 03-04 | F&R | F |
| TC 450                         | 03/05-07    | F   |  | XP 125 Skycruiser                     | 06    | F   | F |
| TE 450                         | 03-07       | F   |  | <b>MOTO GUZZI</b>                     |       |     |   |
| TC 510                         | 04-07       | F   |  | Quota 1100 ES                         | 99-01 | R   |   |
| TE 510                         | 04-07       | F   |  | <b>PIAGGIO</b>                        |       |     |   |
| TC 570                         | 02-03       | F   |  | X9 250 Linked brake f&r wheel 14" dia | 04    | F   | F |
| TE 570                         | 01-04       | F   |  | Beverley 400ie                        | 07    | F   | F |
| TC 610                         | 00          | F   |  | X9 500cc Evolution                    | 03-06 | F   | F |
| TC 610 E                       | 95-99       | F   |  | X9 500ie                              | 07    | F   | F |
| TE 610                         | 00          | F   |  | <b>SHERCO</b>                         |       |     |   |
| TE 610 E                       | 95-00/02-03 | F   |  | 2.5i Enduro (4T)                      | 06    | F   | F |
| TE 610/IE                      | 06-07       | F   |  | 4.5i (450 Enduro/SM)                  | 04-06 | F   | F |
| <b>KEEWAY</b>                  |             |     |  | 5.1i Enduro (4T)                      | 06-07 | F   | F |
| Silverblade 125/150/250        | 07          | F   |  | 5.1i Supermotard                      | 06-07 | F   | F |
| <b>KRAM-IT (KRAMER)</b>        |             |     |  | <b>SUZUKI</b>                         |       |     |   |
| GS 250                         | 00-         | F   |  | UH 125 K2/K3/K4/K5/K6 Burgman         | 02-06 | F   |   |
| SM 250                         | 00-         | F   |  |                                       |       |     |   |

# FA181 Contd.

## TM

|                                      |       |   |
|--------------------------------------|-------|---|
| 80 Enduro                            | 96-00 | F |
| 80/85 Cross                          | 96-01 | F |
| 80/85/100 (Big wheel)                | 02-04 | F |
| Junior 80/85/100 Cross (Small wheel) | 02-04 | F |
| Junior 80/85/100                     | 05-07 | F |
| 125 Cross                            | 95-00 | F |
| Cross MX 125 (2T)                    | 01-07 | F |
| 125 Enduro                           | 95-00 | F |
| Enduro EN 125 (2T)                   | 01-07 | F |
| 250 Cross                            | 95-00 | F |
| 250 (4T) Cross                       | 02-07 | F |
| Cross MX 250 (2T)                    | 01-07 | F |
| 250 Enduro                           | 95-00 | F |
| Enduro EN 250 (2T)                   | 01-07 | F |
| EN 250 F (4T) Enduro                 | 04-07 | F |
| 300 Cross                            | 95-00 | F |
| Cross MX 300 (2T)                    | 01-07 | F |
| Enduro EN 300 (2T)                   | 01-07 | F |
| 300 Enduro (2T)                      | 95-00 | F |
| 400 (4T) MX Cross                    | 02-03 | F |
| 400 Cross (4T)                       | 95-00 | F |
| EN 450 F (4T)                        | 04-07 | F |
| MX 450 F (4T)                        | 04-07 | F |

## TM Contd.

|  |       |     |
|--|-------|-----|
| 530 Cross (4T)                             | 98-00 | F   |
| EN 530 F (4T)                              | 04-07 | F   |
| <b>VECTRIX</b>                             |       |     |
| Vectrix Electric Std Scooter               | 07    | F&R |
| Vectrix Electric 3W (MP3 style scooter)    | 07    | R   |
| <b>VERTEMATI</b>                           |       |     |
| All models (2 piston Brembo)               | 99-04 | F   |
| <b>VOR</b>                                 |       |     |
| All models (2 piston Brembo)               | 03-04 | F   |
| <b>YAMAHA</b>                              |       |     |
| YP 125 Majesty                             | 98-07 | F   |
| XQ 125/150 N Maxster                       | 01-03 | F   |
| VP 300 R/S Versity                         | 03-04 | F&R |
| XC 300 V Versity                           | 06    | F&R |
| TT 600 R (5CH1/5CH2/5CH3)                  | 97-02 | F   |
| TT 600 RE (5CH5)                           | 04    | F   |
| TT 600 E (4LW3/4LW4/4GV4/4GV5)             | 94-01 | F   |
| TT 600 E (4GV2)                            | 94-95 | F   |
| TT 600 K (4LW1/4GV1/4LW2) Up to 4GV 003403 | 93-95 | F   |
| TT 600 K From 4GV 003404                   | 95-96 | F   |

### Equivalents OE #

|                |              |              |                |             |
|----------------|--------------|--------------|----------------|-------------|
| 546 13 209 044 | 5SE F5811 00 | AB024 S      | 503 13 030 100 | BQ300222068 |
| 5CH F5911 00   | 8A0074181    | 59330 49F00  | 8113593        | K00976315   |
| 5DS F5811 00   | 8B0074181    | 5SE F5811 10 | 0624           | 80009634    |
| 4GV F5911 00   | 8C0074181    | K00976315    | 59330 49F00    | BQ300222065 |
| 8000 88482     | 800074181    | 497396       | 00306546250    |             |
| 5NR F5811 00   | AB024        | 800074181    | 613 4 072 1A   |             |

| MATERIAL AVAILABILITY AND PART NO. |         |        |        |          |
|------------------------------------|---------|--------|--------|----------|
| STD                                | OPTIONS |        |        |          |
| FA                                 | HH      | R      | MXS    | GFA      |
| FA181TT                            | FA181HH | FA181R | MXS181 | GFA181HH |

### Competitor X Ref

|               |               |            |               |
|---------------|---------------|------------|---------------|
| <b>Dunlop</b> | <b>Ferodo</b> | <b>SBS</b> | <b>Vesrah</b> |
| DP617         | FDB2018       | 671        | VD-947        |

# FA182 74.8 x 53.9 x 10mm

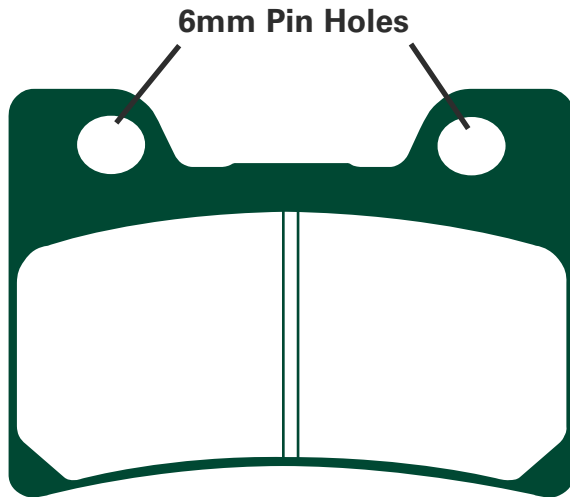

## YAMAHA

FZR 1000 EX UP 91-93 F

### Equivalents OE #

3GM W0045 50

### Competitor X Ref

|               |               |            |               |
|---------------|---------------|------------|---------------|
| <b>Dunlop</b> | <b>Ferodo</b> | <b>SBS</b> | <b>Vesrah</b> |
| DP415         | FDB637        | 665        | VD-257        |

| MATERIAL AVAILABILITY AND PART NO. |         |   |     |     |
|------------------------------------|---------|---|-----|-----|
| STD                                | OPTIONS |   |     |     |
| FA                                 | HH      | R | MXS | GFA |
| FA182                              | FA182HH | - | -   | -   |





# FA185 Contd.

## HONDA Contd.

|   |       |   |
|---|-------|---|
| XF 400 R5/R6 (NC38E) Motard             | 05-06 | F |
| CRF 450 R2/R3/R4/R5/R6                  | 02-06 | F |
| CRF 450 X5/X6                           | 05-06 | F |
| TRX 450 R4/R5/R6/ER6/R7/ER7             | 04-07 | F |
| CR 500 RS/RT/RV/RW/RX/R1                | 95-01 | F |
| XR 600 RP/RR/RS/RT/RV/RW/RX/R1          | 93-00 | F |
| XL 600 VV/VW/VX Transalp                | 97-00 | F |
| XL 650 VY/V1/V2/V3/V4/V5/V6/V7 Transalp | 00-07 | F |
| XR 650 RY/R1-R7                         | 00-07 | F |
| XR V 750 P/R/S/T/V/W/X/Y 'Africa Twin'  | 94-03 | F |

## HONDA DALL'ARA

|               |    |   |
|---------------|----|---|
| XR 125 SM     | 04 | F |
| XR 250 R      | 04 | F |
| XR 250 SM     | 04 | F |
| XR 400/440 R  | 04 | F |
| XR 400/440 SM | 04 | F |
| XR 650 R      | 04 | F |

## HONDA-HM (ITALY)

|                                   |       |   |
|-----------------------------------|-------|---|
| CRE 125 R Supermotard             | 02-03 | F |
| CRE 125 R Enduro                  | 02-06 | F |
| CRF 230 Easy Trail                | 04    | F |
| CRF 230 Easy Enduro               | 04    | F |
| CRF 230 Easy Motard               | 04    | F |
| CRF 230 F Easy Trial (All models) | 04-07 | F |
| CRE 250 R Supermotard             | 02-03 | F |
| CRE 250 R Enduro                  | 02-06 | F |
| CRE 250 R Moto                    | 04    | F |
| CRE 250 F Enduro                  | 04-06 | F |
| CRE 250 X                         |       | F |
| CRF 250 Motard                    | 04    | F |
| CRE F 290 X                       | 07    | F |
| CRE 450 F Enduro                  | 02-04 | F |
| CRF 450 Motard                    | 04    | F |
| CRE 450 Supermoto                 | 02-03 | F |
| CRE 450 X                         |       | F |
| CRE F 490 X                       | 07    | F |
| CR 125 Motard                     | 04    | F |

## KAWASAKI

|  |       |   |
|--|-------|---|
| KX 125 K1/K2/K3/K4/K5/L1<br>/L2/L3/L4/M1/M2/M3/M6F/M7F | 94-07 | F |
| KDX 200 H1/H2/H3/H4/H5                                 | 95-99 | F |
| KDX 220 R A4/A5/A6/A7/A8/A9<br>/A10/A11/A12/A6F        | 97-06 | F |
| KDX 220 SR (DX 220 B)                                  |       | F |
| KLX 250 F1-F4  | 94-97 | F |

## KAWASAKI Contd.

|                                     |       |   |
|-------------------------------------|-------|---|
| KLX 250 R D1/D2                     | 93-94 | F |
| KLX 250 G1                          | 94    | F |
| KLX 250 J1-J6 D-Tracker             | 98-03 | F |
| KLX 250 H6                          | 04    | F |
| KX 250 F (KX 250 N1/N2)             | 04-05 | F |
| KX 250 K1-K5/L1-L4/M1-M2/R1/R6F/R7F | 94-07 | F |
| KX 250 F (T6F/T7F)                  | 06-07 | F |
| KLX 300 A2-A10/A6F/A7F              | 97-07 | F |
| KLX 400 R (KLX 400 B1/B2)           | 03-04 | F |
| KLX 450 R (A8F)                     | 07    | F |
| KX 450 F (D6F/D7F)                  | 06-07 | F |
| KX 500 E6-E16                       | 94-04 | F |
| KLX 650 C1/C2/C3                    | 93-97 | F |

## SUZUKI

|  |       |   |
|--|-------|---|
| RM 125 T/V/W/X/K1/K2/K3/K4/K5/K6/K7  | 96-07 | F |
| 250 SBK2 (LX 250 L)  | 02    | F |
| DR 250 RLV/RL/RLY/RS/RLS/RT/RV/RL/RL<br>/RLW/RW/R1 (SJ45A/DOHC)                                    | 95-00 | F |
| DR 250 RXT/RXLT/RTV/RXLV/RXLW/RXLW<br>/RXGW/RXGLW/RXY/RXGY<br>(Dejbel 250 XC/GPS Ver (SJ45A))      |       | F |
| DR-Z 250 K1-K7   | 01-07 | F |
| RM 250 T/V/W/X/K1/K2/K3/K4/K5/K6/K7  | 96-07 | F |
| RMX 250 T/V/W  | 96-98 | F |
| RMX 250 ST/SV/SW/SX (SJ14A)  | 96-99 | F |
| RM-Z 250 K4/K5/K6/K7   | 04-07 | F |
| DR 350 SEW/SEX   | 98-99 | F |
| DR-Z 400 SEY/EY/Y/SEK1/EK1/K1/K2/SEK2/EK2/K3/SEK3<br>/EK3/K4/SEK4/EK4/SK5/EK5/K5/SK6/K6/EK7/SK7/K7 | 00-07 | F |
| DR-Z 400 SMK5/SMK6/SMK7  | 05-07 | F |
| RM-Z 450 K5/K6/K7  | 05-07 | F |
| DR 650 SET   | 96    | F |

## YAMAHA

|   |       |   |
|---|-------|---|
| YZ 125 K/L/M/N/P/R/S/T/V/W                      | 98-07 | F |
| WR 250 ZK                                       | 98    | F |
| WR 250 FN/FP/FR/FS/FT/FV/FW                     | 01-07 | F |
| YZ 250 K/L/M/N/FN/P/FP/R/FR/S/FS/T/FT<br>FV/V/W | 98-07 | F |
| YZ 400 FK/FL                                    | 98-99 | F |
| WR 400 FL/FM                                    | 99-01 | F |
| WR 426 FN/FP                                    | 01-02 | F |
| YZ 426 FM/FN/FP                                 | 00-02 | F |
| YZ 450 FR/FS/FT/FV/FW                           | 03-07 | F |
| WR 450 FR/FS/FT/FV/FW                           | 03-07 | F |

### Equivalents OE #

|               |               |               |               |
|---------------|---------------|---------------|---------------|
| 06455 GZ8 405 | 45105 KT0 405 | 43082 S009    | 59300 3K880   |
| 06455 KCZ 000 | 45105 KZ1 405 | 43082 1286    | 59301 36810   |
| 06455 MY1 405 | 45105 MY6 405 | 45105 KTO 405 | K4308 21225   |
| 06455 MAY 000 | 45105 KV6 701 | 45105 KZI 405 | K4308 21286   |
| 06455 KBR 731 | 45106 KV6 701 | 5DH W0045 00  | BE 2500 22065 |
| 06455 KHA 941 | 43082 1149    | 5DH W0045 10  | BC 2500 22065 |
| 06455 MAW 761 | 43082 1152    | 5MV W0045 00  | 59300 29860   |
| 06456 MAW 761 | 43082 1172    | 59300 13830   | 43082 0026    |
| 06455 MCB 611 | 43082 1193    | 59300 13860   | 9100788       |
| 06455 HP1 006 | 43082 1218    | 59300 36850   | 43082 0049    |
| 06456 MCB 611 | 43082 1266    | 59300 36860   | BE250022065   |
| 43082 124     | 43082 S011    | 59300 36870   |               |

### Competitor X Ref

| Dunlop | Ferodo | SBS | Vesrah |
|--------|--------|-----|--------|
| DP321  | FDB892 | 694 | VD-161 |

### MATERIAL AVAILABILITY AND PART NO.

| STD     | OPTIONS |        |        |          |
|---------|---------|--------|--------|----------|
| FA      | HH      | R      | MXS    | GFA      |
| FA185TT | -       | FA185R | MXS185 | GFA185HH |

# FA186 31.5 x 51 x 5.5mm

## CAGIVA

|                 |       |   |
|-----------------|-------|---|
| Blues 50        | 93-95 | R |
| Supercity 50/80 | 93-95 | R |
| Prima 50        | 92-94 | R |

## PIAGGIO

|   |       |   |
|---|-------|---|
| Quartz 50                               | 92-96 | F |
| Sfera 50 RST                            | 95-97 | F |
| Skipper 125/150                         | 94-97 | F |
| Vespa PX 125/150/200                    | 98-07 | F |
| Vespa LX 60 (Special Anniversary Model) | 06    | F |

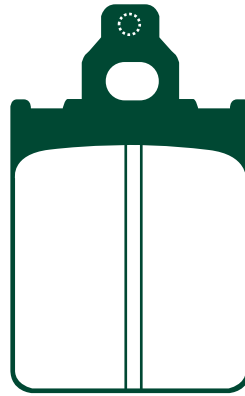

### Equivalents OE #

|           |
|-----------|
| 494762    |
| 498414    |
| 800067127 |

### Competitor X Ref

| Dunlop | Ferodo | SBS | Vesrah |
|--------|--------|-----|--------|
| -      | FDB784 | 680 | VD949  |

### MATERIAL AVAILABILITY AND PART NO.

| STD   | OPTIONS |   |     |     |
|-------|---------|---|-----|-----|
| FA    | HH      | R | MXS | GFA |
| FA186 | -       | - | -   | -   |

# FA187 68 x 54 x 8mm

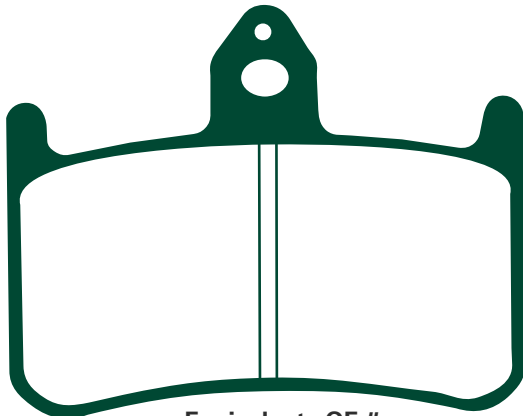

### Equivalents OE #

|               |               |
|---------------|---------------|
| 06455 MAS 305 | 45105 MR7 612 |
| 06455 MBB 006 | 45105 MR7 681 |
| 06455 MCZ 006 | 45105 MW0 405 |
| 06455 MZ1 405 | 45105 MW0 415 |
| 45105 MN8 006 | 45106 KV3 701 |
| 45105 MR7 006 |               |

## HONDA

|  |       |   |
|--|-------|---|
| CB 250 FT/FV/FX/FY/F1 'Hornet'                   | 96-01 | F |
| NSR 250 R2J (MC18)                               | 88    | F |
| NSR 250 RSP/RSK/RSP (MC18)                       |       | F |
| NSR 250 RL/RN/RSP (MC21)                         | 95-   | F |
| NSR 250 RR/R2R (MC28)                            | 94-   | F |
| CB 400 SF (F2V/F3T) Superfour                    | 96-97 | F |
| NT 400 'Bros' NC25                               |       | F |
| VFR 400 R3K/R3L/R3M/R3N (NC30)                   | 89-92 | F |
| RVF 400 RR/RRII/RT/RT-II (NC35)                  | 94-96 | F |
| Bros Product One 650                             |       | F |
| NT 650 J/K/L 'Bros'                              | 88-92 | F |
| VFR 750 RJ/RK/RL (RC30)                          | 88-90 | F |
| RVF 750 RR/RS 'RC45'                             | 94-98 | F |
| CBR 900 RRN/RRP/RRR/RRS/RRT/RRV Fireblade        | 92-97 | F |
| CB 900 F2/F3/F4/F5/F6/F7 Hornet                  | 02-07 | F |
| CB 1000 FP/FR/FS/FT/FV                           | 93-97 | F |
| VTR 1000 FV/FW/FX/FY/F1/F2/F3/F4/F5/F6 Firestorm | 97-06 | F |
| 'X4' CB 1300 DCV/DCW/DCX/DCY (SC38)              | 97-00 | F |

### Competitor X Ref

| Dunlop | Ferodo | SBS | Vesrah |
|--------|--------|-----|--------|
| DP112  | FDB858 | 622 | VD-154 |

### MATERIAL AVAILABILITY AND PART NO.

| STD   | OPTIONS |   |     |          |
|-------|---------|---|-----|----------|
| FA    | HH      | R | MXS | GFA      |
| FA187 | FA187HH | - | -   | GFA187HH |

# FA188 89 x 53 x 7.3mm

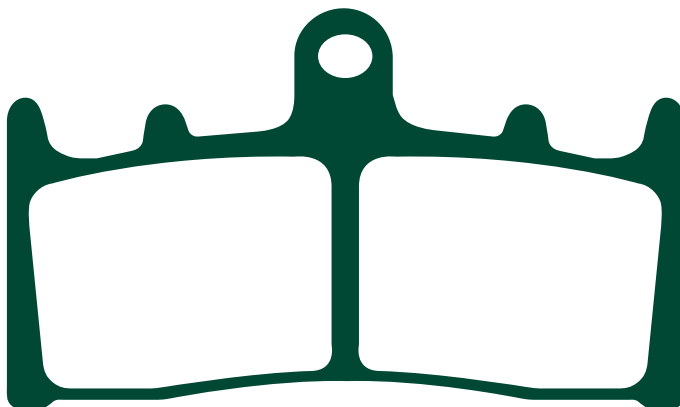

### Competitor X Ref

| Dunlop | Ferodo            | SBS | Vesrah |
|--------|-------------------|-----|--------|
| DP216  | FDB873<br>FDB2144 | 686 | VD-349 |

## KAWASAKI

|                                  |       |   |
|----------------------------------|-------|---|
| ZX-6R (ZX 600 G1/G2/J1/J2)       | 98-01 | F |
| ZX6R (ZX 636 A1P) '636cc'        | 02    | F |
| ZX-7R (ZX 750 P1-P7)             | 96-03 | F |
| GPZ 900 R (ZX 900 A12-15)        | 99-02 | F |
| ZX-9R (ZX 900 B3/B4/C1/C2/E1/E2) | 96-01 | F |
| ZRX 1100 C1/C2/C3/C4             | 97-00 | F |
| ZX12R (ZX 1200 A1/A2/B1/B2)      | 00-03 | F |
| ZRX 1200 R(A1/A2/A3/A4/A5/A6F)   | 01-07 | F |
| ZRX 1200 S (B1/B2/B3)            | 01-04 | F |
| VN 1500 Mean Streak P1/P2        | 02-04 | F |
| VN 1600 B1 Mean Streak           | 04    | F |

## SUZUKI

|  |       |   |
|--|-------|---|
| GSXR 750 WR/WS   | 94-95 | F |
| GSXR 750 T/V/W/X   | 96-99 | F |
| GSXR 1000 K1/K2  | 01-02 | F |
| GSXR 1100 WP/WR/WS/WT  | 93-96 | F |
| TL 1000 RW/RX/RV/RK1   | 98-02 | F |
| GS 1200 SSK1/ZK1 (GV78A)                                     | 02    | F |
| GSF 1200 SK1/K1/K2/SK2/K3/SK3/K4<br>/SK4/K5/SK5              | 01-05 | F |
| GSX 1300 RX/RV/RK1/RK2/RZK3/RK3/RK4/<br>RK5/K6/K7 'Hayabusa' | 99-07 | F |
| GSX 1400 K1/K2/K3/K4/K5/K6/K7                                | 01-07 | F |
| VZ 1600 K4 Marauder  | 04    | F |

### Equivalents OE #

|                 |            |             |
|-----------------|------------|-------------|
| 43082 1199      | 43082 1179 | 43082 1274  |
| 43082 1224      | 43082 1227 | 59301 33870 |
| 59130 46E00     | 43082 1230 | 59100 46820 |
| 59300 33870     | 43082 1250 | 43082 1251  |
| 59300 33890     | 43082 1253 | 59100 40830 |
| 59300 46840/830 | 43082 1259 | K4308-21274 |
| 59300 46820     | 43082 1272 |             |

# FA189 125.5 x 45.1 x 9mm

**HONDA**

CBR 1000 FP/FR/FS/FT/FV/FW/FX

93-99 F&R

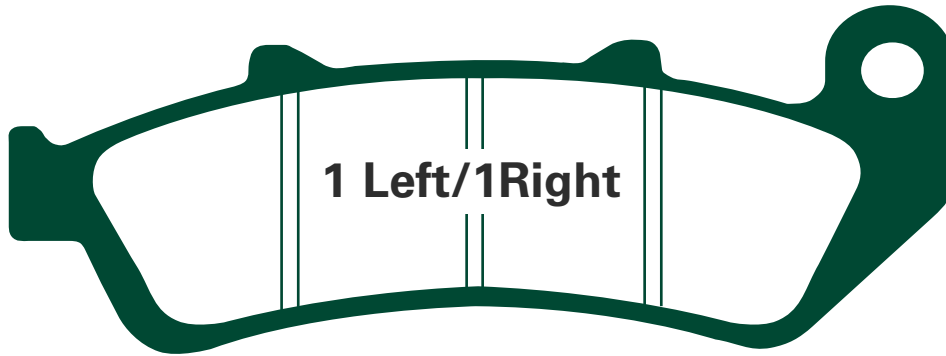

**Equivalents OE #**

|               |
|---------------|
| 06455 MZ2 405 |
| 06455 MAJ G41 |
| 06435 MAJ G41 |
| 06435 MAT 006 |
| 06455 MZ2 405 |

**Competitor X Ref**

|                        |                          |                   |                         |
|------------------------|--------------------------|-------------------|-------------------------|
| <b>Dunlop</b><br>DP122 | <b>Ferodo</b><br>FDB2002 | <b>SBS</b><br>685 | <b>Vesrah</b><br>VD-164 |
|------------------------|--------------------------|-------------------|-------------------------|

| MATERIAL AVAILABILITY AND PART NO. |         |   |     |     |
|------------------------------------|---------|---|-----|-----|
| STD                                | OPTIONS |   |     |     |
| FA                                 | HH      | R | MXS | GFA |
| FA189                              | FA189HH | - | -   | -   |
| FA189S (Green)                     |         |   |     |     |

**LINKED BRAKE  
FIT ALL THREE SETS  
AT PAD CHANGE**

# FA190 98.9 x 49.5 x 9.5mm

# FA190HH 98.9 x 49.5 x 8.5mm

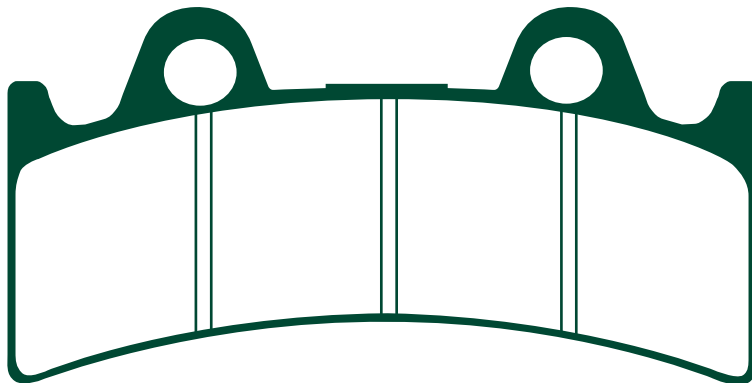

**Equivalents OE #**

|              |          |
|--------------|----------|
| 4FM W0045 00 | T2020221 |
| 4FM W0045 10 | T2020218 |
| T2020211     |          |

**Competitor X Ref**

|                        |                         |                   |                         |
|------------------------|-------------------------|-------------------|-------------------------|
| <b>Dunlop</b><br>DP416 | <b>Ferodo</b><br>FDB864 | <b>SBS</b><br>683 | <b>Vesrah</b><br>VD-258 |
|------------------------|-------------------------|-------------------|-------------------------|

| MATERIAL AVAILABILITY AND PART NO. |         |   |     |          |
|------------------------------------|---------|---|-----|----------|
| STD                                | OPTIONS |   |     |          |
| FA                                 | HH      | R | MXS | GFA      |
| FA190                              | FA190HH | - | -   | GFA190HH |

**TRIUMPH**

Daytona Super III (3 cyl)

94-97 F

**YAMAHA**

YZF 750 R/SP

93-97 F

FZR 1000 EX UP

94-95 F

**ALCON**

6 Piston Caliper (Large Pin)

**PERFORMANCE MACHINE**

112X6RSB

112X6SSB

125X6QC

**PRE TECH**

6 Piston Caliper

# FA191 131.9 x 80 x 9.5mm

**YAMAHA**  
GTS 1000

93-99

F

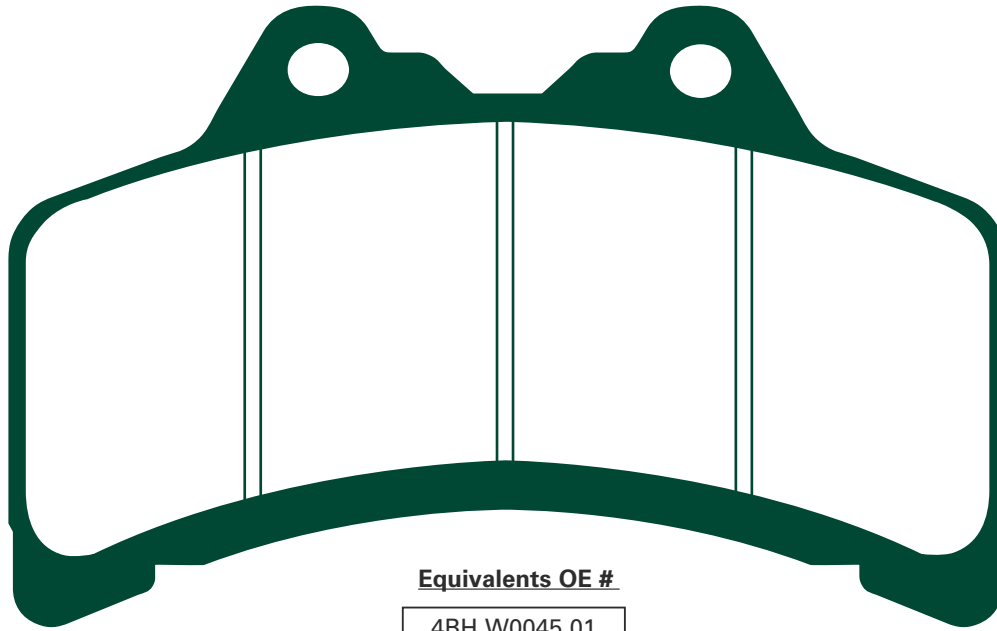

**Equivalents OE #**

4BH W0045 01

| MATERIAL AVAILABILITY AND PART NO. |         |   |     |     |
|------------------------------------|---------|---|-----|-----|
| STD                                | OPTIONS |   |     |     |
| FA                                 | HH      | R | MXS | GFA |
| FA191                              | -       | - | -   | -   |

| Competitor X Ref |        |     |        |
|------------------|--------|-----|--------|
| Dunlop           | Ferodo | SBS | Vesrah |
| -                | FDB865 | 682 | VD-259 |

# FA192 A. 90 x 51 x 8.5mm B. 68 x 52 x 9.5mm

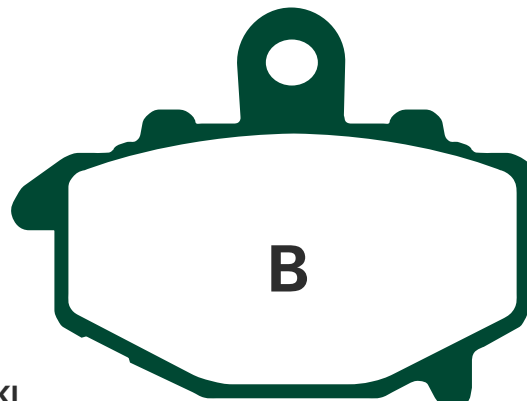
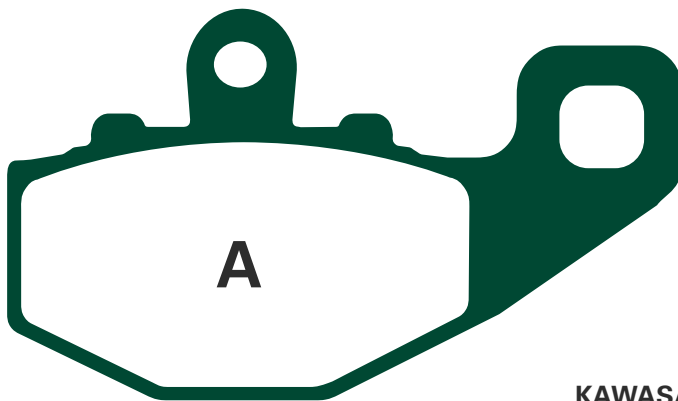

**Equivalents OE #**

|            |            |
|------------|------------|
| 43082 1148 | 43082 1171 |
| 43082 1157 | 43082 1213 |
| 43082 1160 | 43082 0004 |

**KAWASAKI**

|  |       |   |
|--|-------|---|
| ZR 400 Zephyr (G2/G3/G3A/G4/G5)        | 97-01 | R |
| ZRX 400 (ZR 400 E1-E7)                 | 95-01 | R |
| ZZR 400 (ZX 400 N1/N2/N3/N4/N5/N6/N7)  | 93-99 | R |
| ZR 550 B4/B5/B6 "Zephyr"               | 94-99 | R |
| ZZR 600 (ZX 600 E1-E13)                | 93-05 | R |
| ZZR 600 (ZX 600 E6F)                   | 06-07 | R |
| ZX-6R (ZX 600) F1/F2/F3/G1/G2/J1/J2)   | 95-01 | R |
| ZX6R (ZX 636 A1P/B1/B2/C1) 636cc       | 02-05 | R |
| ZX6R (ZX 600 P7F)                      | 07    | R |
| ZX6RR (ZX 600 K1/M1/N1)                | 03-05 | R |
| ER-6F (EX 650 A6F/B6F/A7F/B7F)         | 06-07 | R |
| ER-6N (ER 650 A6F/B6F/A7F/B7F)         | 06-07 | R |
| KLE 650 A7F Versys                     | 07    | R |
| KLE 650 B7F Versys ABS                 | 07    | R |
| Z 750 (ZR 750 J1/J2)                   | 04-05 | R |
| Z 750 S (ZR 750 K1/K6F)                | 05-07 | R |
| ZX-9R (ZX 900 B1/B2/B3/B4/C1/C2/E1/E2) | 94-01 | R |
| ZX9R (ZX 900 F1/F2)                    | 02-04 | R |
| Z 1000 (ZR 1000 A1/A2/A3)              | 03-05 | R |
| ZX 10 R (ZX 1000 C1/C2/D6F/D7F)        | 04-07 | R |
| GPZ 1100 E1/E2/F1                      | 95-98 | R |

**Competitor X Ref**

| Dunlop | Ferodo   | SBS | Vesrah |
|--------|----------|-----|--------|
| DP320  | FDB2012R | 687 | VD-434 |

| MATERIAL AVAILABILITY AND PART NO. |         |   |     |     |
|------------------------------------|---------|---|-----|-----|
| STD                                | OPTIONS |   |     |     |
| FA                                 | HH      | R | MXS | GFA |
| FA192                              | FA192HH | - | -   | -   |

# FA193 39.8 x 51.2 x 7mm

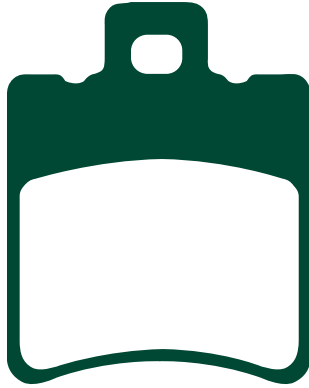

**Competitor X Ref**

|               |               |                 |               |
|---------------|---------------|-----------------|---------------|
| <b>Dunlop</b> | <b>Ferodo</b> | <b>SBS</b>      | <b>Vesrah</b> |
| DP633         | DP680         | 725/697/667/771 | VD948         |

**Equivalent OE #**

|               |              |                |
|---------------|--------------|----------------|
| 119 439 00    | 3YK W0045 01 | 821 3246       |
| 119 468 00    | 4CU F5811 20 | 498408         |
| 119 502 00    | 4CU W0045 00 | R434 2009 1A0  |
| 2525370000    | 4VV F5811 00 | R434 2021 1A0  |
| 2525240000    | 5ME FS811 00 | R444 2004 1A0  |
| 59300 09820   | 5MF F5811 00 | 752667         |
| 59300 35810   | 5RW FS811 00 | 498454         |
| 59330 09EFO   | 811 3638     | 821 3571       |
| 59330 35E00   | 811 3644     | 821 3638       |
| 06455 GBM 750 | 811 3663     | 647172         |
| 06455 GCM 900 | 821 3192     | 45120 J4A T000 |
| 06455 GBY 910 | 821 3245     |                |

**MATERIAL AVAILABILITY AND PART NO.**

| STD          | OPTIONS        |   |     |     |
|--------------|----------------|---|-----|-----|
| FA           | HH             | R | MXS | GFA |
| <b>FA193</b> | <b>FA193HH</b> | - | -   | -   |

**APRILIA**

|   |       |     |
|---|-------|-----|
| Amico (All models)                        | 96-98 | F   |
| Gulliver (All models)                     | 95-98 | F   |
| SR (All models) with rear drum            | 97-02 | F   |
| Rally A/C (All models)                    | 95-02 | F   |
| Rally LC (All models)                     | 96-00 | F&R |
| Scarabeo                                  | 93-97 | F   |
| SR 50 (All models with rear disc)         | 97-00 | F&R |
| SR 50 (All models with rear disc)         | 00-07 | F   |
| Sonic/GP/Spice (All models)               | 98-07 | F   |
| Scarabeo 50/100                           | 98-03 | F&R |
| Scarabeo 50 (Di-Tech)                     | 01-04 | F   |
| Scarabeo 50 (4 stroke Piaggio motor) (4T) | 02-07 | F   |
| Mojito/Mojito Custom 50                   | 03-07 | F   |
| Scarabeo 50/100 (Rear drum models) (2T)   | 98-07 | F   |
| Habana 50                                 | 99-01 | F   |
| SR 50 Diotech (Piaggio Motor)             | 03-05 | F   |
| SR 125                                    | 99    | F   |
| Leonardo 125/150                          | 96-98 | F&R |
| Area 51                                   | 98-02 | F&R |

**ATALA**

|               |    |   |
|---------------|----|---|
| Hacker LC     | 97 | F |
| Hacker Racing | 97 | F |
| Byte RT10     | 97 | F |
| Hacker        | 97 | F |

**BENELLI**

|                                  |       |     |
|----------------------------------|-------|-----|
| 491 All rear drum models         | 98-04 | F   |
| 491 Scooter All rear disc models | 99-04 | F&R |
| Naked 50                         | 02-03 | F   |
| Naked 100                        | 02    | F   |
| Pepe 50/50 LX                    | 99-07 | F   |
| K2 Scooter                       | 98-01 | F   |
| K2 100                           | 99-01 | F   |
| Pepe 100 LX                      | 99-02 | F   |
| Velvet 125/150                   | 99-06 | F&R |
| Adiva 125/150                    | 00-04 | F   |

**BETA**

|                   |       |     |
|-------------------|-------|-----|
| Quadra 50         | 97-02 | F   |
| Ark 1 (LC models) | 97-07 | F&R |
| Tempo 50          | 98-02 | F   |
| Ark (A/C models)  | 96-07 | F   |

**CAGIVA**

|            |    |   |
|------------|----|---|
| Nuvola 50  | 00 | F |
| Nuvola 125 | 00 | F |

**GILERA**

|                              |       |   |
|------------------------------|-------|---|
| Stalker 50                   | 97-06 | F |
| 50 DD/SP Runner/Purejet      | 99-04 | F |
| Ice 50                       | 01-03 | F |
| Runner 50                    | 98    | F |
| SKP 50                       | 98-01 | F |
| Storm 50                     | 94-95 | F |
| Easy Moving 50               | 95-96 | F |
| Stalker 50 (Rear drum model) | 97-02 | F |

**GARELLI**

|               |    |   |
|---------------|----|---|
| Flo 50        |    | F |
| Skynet 250/40 | 02 | R |

**HONDA**

|   |       |   |
|---|-------|---|
| SFX 50 S/T/V/W/X/Y/1                          | 95-04 | F |
| SGX 50 V/W/X/Y/1 "Sky deluxe"                 | 97-03 | F |
| SH 50 T Fifty/Scoopy W/X/Y/1                  | 97-03 | F |
| SRX 50 W/SW/X/SX                              | 98-99 | F |
| SZX 50 (X8R) SW/SX/SY/S1 "Supersport Scooter" | 98-04 | F |
| SZK 50 (X8R) XW/XX/XY/X1 "Cross Sport"        | 98-04 | F |
| SH 100 T/W/X/Y/1 Scoopy                       | 96-01 | F |

**ITALJET**

|            |       |     |
|------------|-------|-----|
| 50 Formula | 98-00 | F&R |
|------------|-------|-----|

**MALAGUTI**

|  |       |     |
|--|-------|-----|
| F18 Warrior 125/150                    | 00-03 | F   |
| Ciak 50/100                            | 00-04 | F   |
| Ciak 50                                | 00-03 | F&R |
| Ciak 50 (4T) Master                    | 04-07 | F   |
| Ciak 100                               | 99-03 | F&R |
| Ciak (electrical power)                | 00-05 | F   |
| F10 Jetline/Jetline WAP                | 94-07 | F   |
| F12 50 Phantom                         | 98-02 | R   |
| F12 Phantom (All liquid cooled models) | 99-07 | F&R |
| F15 RR                                 | 99-01 | R   |
| F12 Phantom (A/C)                      | 02-07 | F   |
| F15 Firefox (Liquid cooled models)     | 01-06 | F&R |
| Firefox F15 (Air cooled models)        | 99-06 | F   |
| F69 Phantom 70                         | 98    | F   |

**MBK**

|                            |       |   |
|----------------------------|-------|---|
| CS 50 Z/CS 50 Mach G       | 02-06 | F |
| CW 50 R Booster Road       | 94-95 | F |
| CW 50 Booster Spirit       | 96-98 | F |
| CW 50 RS Booster NG        | 95-98 | F |
| CW 50 RS Booster NG        | 01-06 | F |
| CW 50 RS Booster Naked     | 04-06 | F |
| CW 50 RSX Booster Track    | 96-98 | F |
| CW 50 RS Booster Spirit    | 99-06 | F |
| CW 50 RSP Rocket           | 97-00 | F |
| CW 50 Fizz 50              | 93-97 | F |
| CW 50 Evolis               | 97    | F |
| CW 50 Power Rocket         | 06    | F |
| CW 50 Booster (12" wheels) | 06    | F |
| YA 50 R Forte              | 94-95 | F |
| YE 50 Evolis               | 92-95 | F |
| YH 50 Flipper              | 98-06 | F |
| YM 50 Fizz                 | 94-95 | F |
| YN 50 R Ovetto             | 98-06 | F |
| YQ 50 Nitro                | 97-06 | F |
| CV 80 Evolis               | 97    | F |
| YN 100 Ovetto              | 99-03 | F |
| YQ 100 Nitro               | 01-02 | F |
| XN 125/150 Doo Do          | 00-05 | F |

**MOTRON**

|            |    |   |
|------------|----|---|
| 50 Sting   | 98 | F |
| 50 Syncro  | 98 | F |
| 50 Thunder | 98 | F |

**PEUGEOT**

|                       |       |   |
|-----------------------|-------|---|
| Buxy/Buxy RS          | 94-97 | F |
| Zenith L (All models) | 96-99 | F |

**PGO**

|                 |       |   |
|-----------------|-------|---|
| Rodo Show 50/90 | 00-06 | F |
|-----------------|-------|---|

**PIAGGIO**

|   |       |   |
|---|-------|---|
| Zip Fast Raider                             | 93-97 | F |
| Free 50                                     | 02    | F |
| NRG 50                                      | 94-96 | F |
| NRG 50 Extreme                              | 99-01 | F |
| NTT 50                                      | 95-96 | F |
| Zip 50 Base (Disc Model)                    | 95-96 | F |
| Zip 50 Elettrico                            | 02    | F |
| NRG 50 RST "MC2" (Rear drum models)         | 96-97 | F |
| NRG 50 RST (DD/DT) "MC2" (Rear drum models) | 98    | F |
| NRG 50 RST "MC2" (Rear disc models)         | 98    | F |
| NRG 50 Extreme (Rear drum models)           | 99-01 | F |
| NRG 50 Extreme (Rear disc models)           | 99-01 | F |
| NRG 50 DT MC3                               | 01-05 | F |
| NRG 50 MC3 DD                               | 01-05 | F |
| Typhoon 50 (All models)                     | 94-05 | F |
| Free 100                                    | 02    | F |
| Hexagon 125/150                             | 94-97 | F |
| Typhoon 125                                 | 95-98 | F |
| Typhoon 125                                 | 99-03 | F |
| Typhoon 125 X-XR                            | 99-00 | F |

**SUZUKI**

|  |       |   |
|--|-------|---|
| AP 50 R/S/T/V/W                              | 96-02 | F |
| AY 50 V/W/V/W/WW/WRW/WRX/WX/WRY/WRK1/WRK2    |       |   |
| /WRK3/WRK4/K1/K2/K3 Katana (Grimeca Caliper) | 97-04 | F |
| UX 50 WX/WY 'Zillion'                        | 99-02 | F |

**YAMAHA**

|  |       |   |
|--|-------|---|
| BW'S 50 Next Generation (Twin headlight model)     |       |   |
| (190mm disc)                                       | 99-07 | F |
| BW'S 50 Original (180mm disc)                      | 99-02 | F |
| CS 50 P/R Jog R                                    | 02-07 | F |
| CS 50 R (Jog RR)                                   | 03-07 | F |
| CW 50 RS (4YA1/2/BW'S) (180mm front disc)          | 96-97 | F |
| CW 50 RS (AYA4/BW'S NG) (180mm front disc)         | 98    | F |
| CW 50 RS (5FXA/VG5SA BW'S) (190mm front disc)      | 99    | F |
| CW 50 RS (5FXJ/VG5SA BW'S) (190mm front disc)      | 00    | F |
| CW 50 RS (5FXM/VG5SA BW'S) (190mm front disc)      | 01-05 | F |
| CW 50 (5MS2/4G54R)                                 | 02    | F |
| CW 50 (5WW4/BW'S)                                  | 05    | F |
| CW 50 RSP (5CC1/3/4YA BW'S Spy) (180mm front disc) | 97-98 | F |
| YA 50 R Axis (4PC)                                 | 95-96 | F |
| YE 50 Zest   | 93-95 | F |
| YFM 50 Breeze (4KH)                                | 94-95 | F |
| YN 50 R Neos                                       | 98-07 | F |
| YQ 50 Aerox R                                      | 97-07 | F |
| YH 50 Why  | 99-07 | F |
| YN 100 Neos 100                                    | 99-03 | F |
| YQ 100 Aerox 100                                   | 00-04 | F |
| XN 125 Teos  | 00-03 | F |

# FA194 A. 95.5 x 42 x 8mm B. 77 x 42 x 8mm

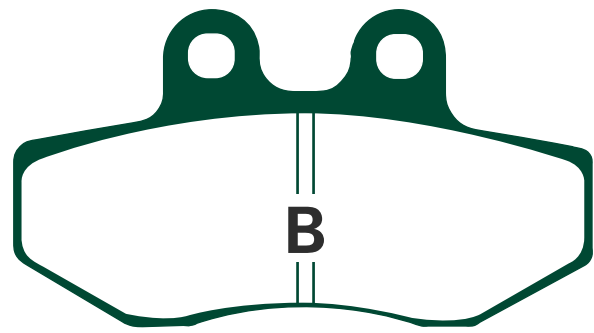
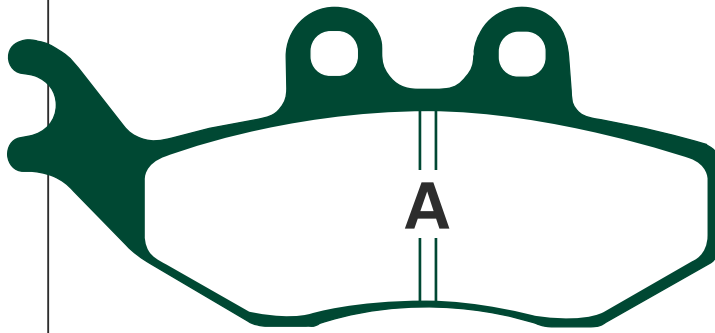

### Equivalents OE #

|            |               |              |
|------------|---------------|--------------|
| 8113478    | R43440 311A0  | 00009300080  |
| 8113523    | 754605        | 1D5 F5811 00 |
| 119 493 00 | 756020        | 00H04703141  |
| 119 495 00 | 5WX W0045 00  | K00976315    |
| 494628     | R290063110000 | 11955700     |

### Competitor X Ref

| Dunlop | Ferodo | SBS | Vesrah |
|--------|--------|-----|--------|
| -      | FDB677 | 689 | VD9015 |

| MATERIAL AVAILABILITY AND PART NO. |         |   |     |     |
|------------------------------------|---------|---|-----|-----|
| STD                                | OPTIONS |   |     |     |
| FA                                 | HH      | R | MXS | GFA |
| FA194                              | FA194HH | - | -   | -   |

### APRILIA

|                  |       |   |
|------------------|-------|---|
| MX 50            | 03-05 | F |
| RS 50            | 99-06 | F |
| RX 50 C/CD       | 93-04 | F |
| RX 50 Racing     | 03-06 | F |
| Tuorno 50        | 03-04 | F |
| ETX 125          | 99-01 | F |
| RX 125           | 92-99 | F |
| Pegaso 125 "Kat" | 94-95 | F |

### BENELLI

|                 |       |   |
|-----------------|-------|---|
| Velvet 250      | 99-07 | F |
| Velvet 400 Dusk | 03-04 | F |

### BETA

|                     |       |   |
|---------------------|-------|---|
| Alp 4.0             | 04-06 | F |
| RR 125 (All models) | 06-07 | F |
| Alp 125/200         | 05-07 | F |
| Alp 4.0             | 05-07 | F |

### CCM

|                        |    |   |
|------------------------|----|---|
| SR 40 Street Scrambler | 07 | F |
|------------------------|----|---|

### CPI

|                |       |   |
|----------------|-------|---|
| GTS 50/125/200 | 02-03 | F |
| GTR 50/125/200 | 02    | F |
| SX 50          | 06-07 | F |

### DAELIM

|        |    |   |
|--------|----|---|
| ST 125 | 03 | F |
|--------|----|---|

### DERBI

|                        |       |   |
|------------------------|-------|---|
| Senda R Euro2          | 04-07 | F |
| Senda R Baja Enduro    | 06-07 | F |
| Senda R Baja Supermoto | 06-07 | F |
| GPI 50 Open            | 06-07 | F |
| Mulhacen 125           | 07    | F |

### FACTORY

|              |       |   |
|--------------|-------|---|
| RP 50        | 05    | F |
| YM 50        | 05    | F |
| YR 50 Desert | 04-05 | F |
| Chrono SM 50 | 04    | F |
| YR 125 4T    | 05    | F |

### GAS GAS

|                     |       |   |
|---------------------|-------|---|
| EC 50               | 05    | F |
| SM 50               | 05    | F |
| Pampera 125/450     | 05-07 | F |
| Pampera 250         | 02    | F |
| Pampera 125/250/280 | 04    | F |
| Pampera 250         | 02-03 | F |

### GENERIC

|               |       |   |
|---------------|-------|---|
| Toxic 50      | 07    | F |
| Trigger X50   | 06-07 | F |
| Trigger SM 50 | 06-07 | F |

### GILERA (Grimeca Calipers)

|                           |       |   |
|---------------------------|-------|---|
| DNA 50                    | 01-06 | F |
| DNA 125/180               | 01-05 | F |
| 125 VX 4T/180 VXR 4T      | 01-04 | F |
| Coguar                    | 00-01 | F |
| Runner 125/180 All models | 98-02 | F |
| VXR 200 Runner (4T)       | 02-04 | F |

### HONDA HM (Italy)

|  |       |   |
|--|-------|---|
| CRE 50 Six/Baja/Derapage Brembo caliper twin pin/41mm Paioli forks | 95-02 | F |
| CRE 50 Baja/Derapage   | 01-02 | F |

### HRD

|       |  |   |
|-------|--|---|
| GS 50 |  | F |
|-------|--|---|

### KEEWAY

|                    |    |   |
|--------------------|----|---|
| X Ray 50 Supermoto | 07 | F |
|--------------------|----|---|

### MALAGUTI

|                     |       |   |
|---------------------|-------|---|
| XSM 50              | 03-07 | F |
| Madison 125/150/180 | 99-03 | F |
| Madison R125        | 03-07 | F |
| Phantom Max 125/200 | 04-07 | F |
| Phantom Max 250     | 04-07 | F |
| Madison S200        | 04    | F |
| R 125 Madison       | 03-06 | F |
| 250 Madison         | 04-07 | F |
| Password 250        | 05-07 | F |

### MBK

|                   |       |   |
|-------------------|-------|---|
| TZR 50 X Power    | 03-06 | F |
| X-Limit Supermoto | 03-06 | F |

### PEUGEOT

|  |       |   |
|--|-------|---|
| Elystar 125/150 (All models)                             | 03-07 | F |
| Elyseo 125/150 Rear Disc Model                           | 03    | F |
| Jet Force 125 (All models)                               | 03-07 | F |
| Satelis 125 4V Executive/Premium/City (4 stroke/4 valve) | 06-07 | F |
| Satelis 125 Compressor (4 stroke) All models             | 06-07 | F |
| XPS-6 Supermotard  | 03-07 | F |
| Geopolis 250 (AJP Caliper)                               | 06-07 | F |
| Satelis 250 (AJP Calipers)                               | 07    | F |

### PGO

|         |    |   |
|---------|----|---|
| RS2 NKD | 05 | F |
|---------|----|---|

### PIAGGIO/VESPA (Grimeca Calipers)

|  |       |     |
|--|-------|-----|
| Beverley B 125                         | 03-06 | F&R |
| Beverley 200                           | 03-05 | F&R |
| Hexagon GT 250                         | 98-99 | F   |
| Hexagon LX 180                         | 98-99 | F   |
| Hexagon LXT 180                        | 98-99 | F   |
| Hexagon LX4 125                        | 98-99 | F   |
| Skipper LX 125/150                     | 98-99 | F   |
| Super Hexagon GTX 125/180 (11" wheels) | 00    | F   |
| Skipper ST 125/150 4T Grimeca Caliper  | 00-04 | F   |
| Super Hexagon GTX 250                  | 00-02 | F   |
| GT 125 L Granturismo                   | 03-06 | F   |
| GT 200 L Granturismo                   | 03-06 | F   |

### RIEJU

|                            |       |   |
|----------------------------|-------|---|
| MRX 50 Pro/Top             | 04-07 | F |
| SMX 50 Pro Supermotard/Top | 04-07 | F |

### SACHS

|                |    |   |
|----------------|----|---|
| ZX 125 Enduro  | 01 | F |
| ZZ 125 Funbike | 02 | F |

### SIAMOTO

|         |    |   |
|---------|----|---|
| SX1 125 | 04 | F |
|---------|----|---|

### YAMAHA

|                       |       |   |
|-----------------------|-------|---|
| DT 50 X (Supermotard) | 04-06 | F |
| TZR 50 (5WX1)         | 03-07 | F |
| XT 125 X              | 05-07 | F |

# FA196 102 x 38 x 9.8mm

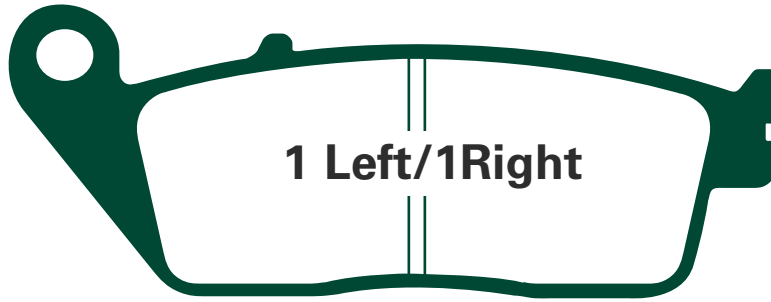

## DAELIM

|                      |       |   |
|----------------------|-------|---|
| VL 125 Daystar/125 L | 03-06 | F |
| VT 125 Evolution     | 03    | F |
| VS 125 Evolution     | 01-04 | F |
| Roadwin (VJ 125)     | 04-07 | F |

## HONDA

|  |       |   |
|--|-------|---|
| CB 250 N/T/W/X/Y/1/4 "Two Fifty"                                   | 92-05 | F |
| CN 250 3 (MF02) Fusion/Fusion X/<br>Fusion X Special               | 03    | F |
| VT 250 Spada   | 89-   | F |
| VT 250 CR/CT/CV 'Magna'  | 95-97 | F |
| VTR 250 W/Y/1-7 (MC33)   | 98-07 | F |
| CB 400 SS (CB 400 SS2-J/SS2-3J-NC41)                               | 01    | F |
| FJS 400 S (NF01) Silverwing 400                                    | 01-02 | R |
| FJS 400 D6 Silverwing  | 06    | R |
| NV 400 DCY/DC1/DC2 (NC40) Shadow Slasher                           | 00-02 | F |
| VRX 400 T (NC33)   | 96    | F |
| CBF 500 4 (Non ABS Model)  | 04    | F |
| CB 500 R/T   | 94-96 | F |
| 600 Silverwing Scooter FJS 600 1/2/A3/D3<br>/A4/D4/A5/D5/A6/D6/A7  | 01-07 | R |
| XL 600 VR/VT "Transalp"  | 94-96 | F |
| FMX 650 5/6  | 05-07 | F |
| CBR 750 FJ 'Superaero'   | -88   | R |
| VF 750 CP/CR/CS/CT/CV/CW/CX  | 93-99 | F |
| VFR 750 FJ/FK/FL/FM/FN/FP/FR/<br>FS/FT/FV                          | 88-97 | R |
| VT 750 CV/C2V/CW/C2W/CX/C2X/CY/C2Y<br>C1/C21/C31/C4/C5/C6 'Shadow' | 97-06 | F |
| VT 750 DC1/DC2 Black Widow   | 01-04 | F |
| VT 750 DCA7 Shadow Spirit  | 07    | F |
| CBR 1000 FK/FL/FM/FN   | 89-92 | R |
| ST 1100 L/M/N/P/R/S/T/V/W/X/Y1/AN/AP/<br>AR/AS/A1 "Pan European"   | 90-01 | R |
| VT 1100 CR/CS/CT/CV/CW Shadow                                      | 94-98 | F |
| VT 1100 C3 Shadow  |       | F |
| VT 1100 C4 Shadow Sabre  | 04-05 | F |
| VTX 1300 S3/S4/S5/S6/S7  | 03-07 | F |
| GL 1500 'CV/CW/CX/CY/C1/C2 (F6C)'                                  | 97-03 | R |

## KYMCO

|                    |       |   |
|--------------------|-------|---|
| Venox 250 (Custom) | 00-06 | F |
| Xciting 250/250i   | 05-07 | R |
| Xciting 500/500i   | 04-07 | R |
| Yup 250            | 04-06 | R |
| People 250 S       | 06    | R |

## SYM

|             |    |     |
|-------------|----|-----|
| Voyager 125 | 05 | F&R |
|-------------|----|-----|

## TRIUMPH

|  |       |     |
|--|-------|-----|
| Adventurer                                   | 96-01 | F&R |
| America (cast wheel)                         | 07    | F   |
| Bonneville America                           | 02-06 | F   |
| Bonneville 800                               | 01-06 | F   |
| Bonneville/Bonneville Black (865cc)          | 07    | F   |
| Bonneville T100                              | 02-06 | F   |
| Legend TT                                    | 98-01 | F&R |
| Speedmaster 800                              | 03-04 | F   |
| Speedmaster (865cc)                          | 05-07 | F   |
| Thunderbird                                  | 95-03 | F&R |
| Thunderbird Sport                            | 98-03 | F&R |
| Tiger 885cc                                  | 92-99 | F&R |
| Tiger 955cc Up to VIN 198874                 | 00-04 | F&R |
| Tiger 955 (Cast wheel model) from VIN 198875 | 05-06 | F   |
| Scrambler (865cc)                            | 06-07 | F   |
| Tiger 855i (From VIN 71699)                  | 98-99 | F&R |

## YAMAHA

|                                       |       |   |
|---------------------------------------|-------|---|
| YP 125 Majesty DX (Taiwan Production) | 02    | F |
| VP 250 W (X-City)                     | 07    | F |
| MT-01 (1670cc)                        | 05-06 | R |
| MT-01 (6 piston radial caliper)       | 07    | R |

### Equivalents OE #

|               |                 |                  |
|---------------|-----------------|------------------|
| 06435 MCT 405 | 06455 MAA 405   | 45106 MN8 671B   |
| 06435 ML7 P01 | 06455 MBK 751   | 45106 MS9 612B   |
| 06435 ML7 415 | 06455 MEA 671   | 45106 MW3 671    |
| 06435 MS2 P00 | 431A0 MT4 670   | T2020077         |
| 06435 MT3 405 | 43105 ML7 921A  | T2020194         |
| 06435 MS9 405 | 43105 ML7 922A  | T2020537         |
| 06435 MZO 006 | 43105 MS2 007A  | 06455 KFR 701    |
| 06455 MZO 760 | 43105 MS9 612A  | 45105 KED9 305   |
| 06455 MAW 621 | 43105 MT3/6 007 | 5YU W0046 00     |
| 06455 MAB 405 | 43105 MT4 007A  | 06455 MCK A01    |
| 06455 MAH 405 | 43105 MY7 405   | 45105 BA5 RB10M1 |
| 06455 KCR 405 | 43106 ML7 921B  | 45106 BA5 RB10M1 |

### Competitor X Ref

| Dunlop | Ferodo | SBS | Vesrah     |
|--------|--------|-----|------------|
| DP118  | FDB664 | 700 | VD-156/2/3 |

| MATERIAL AVAILABILITY AND PART NO. |         |   |     |     |
|------------------------------------|---------|---|-----|-----|
| STD                                | OPTIONS |   |     |     |
| FA                                 | HH      | R | MXS | GFA |
| FA196                              | FA196HH | - | -   | -   |



# FA197 A. 96.7 x 42 x 9mm B. 77.3 x 42 x 9mm

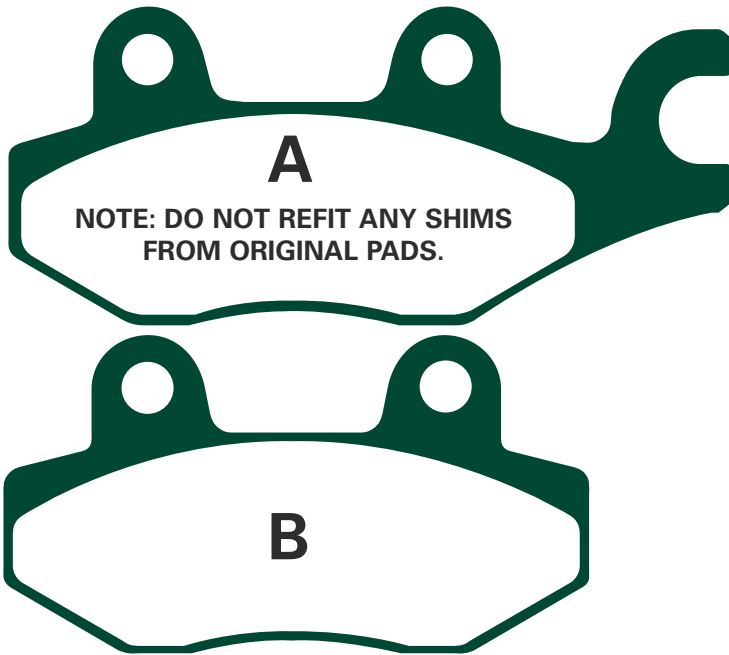

**A**  
NOTE: DO NOT REFIT ANY SHIMS FROM ORIGINAL PADS.

|  |       |     |
|--|-------|-----|
| <b>AJS</b>                                 |       |     |
| Regal Raptor DD 125 E                      | 04-06 | F   |
| Regal Raptor DD 250 E                      | 04-06 | F   |
| <b>HONDA</b>                               |       |     |
| CB 50 V/W Dream 50                         | 97-98 | F   |
| NSR 50 RV/RW/RX/RY                         | 97-00 | F   |
| XR 50 M5 (AD14) Motard                     | 05    | F   |
| NSR 75 N/P/R/X/Y (N5-1/NSR 80)             | 92-00 | F   |
| NSR 80 P/R/S (HC06)                        | 93-   | F   |
| Astra Supra NF 100                         | 99    | F   |
| XR 100 M5 (HD13) Motard                    | 05    | F   |
| LS 125 RY                                  | 00-   | R   |
| VT 125 CX/CY/C1/C21/C2Y /C3/C4/C7 'Shadow' | 99-07 | F   |
| XL 125 V1/V2/V3/V4/V5/V6/V7 'Varadero'     | 01-07 | F   |
| NSR 150 RR (Malaysian market)              |       | F&R |
| TA 200 (TA Shadow)                         | 02-05 | F&R |
| CBF 250 4/7                                | 04-07 | F   |

### Equivalents OE #

|               |                   |                 |
|---------------|-------------------|-----------------|
| 06455 KPC 641 | 43108 H3C 000A    | 902 300 1000    |
| 06455 GCR 006 | 45105 KR3 871     | 45105 KW6 405   |
| 3LD W0045 10  | 45106 KR3 871     | 45150 LLB5 3050 |
| 3LD W0045 30  | 4510A KW6 9000    | 4510A KFW6 900  |
| 06455 KR3 000 | 45105 KBE 3050 M2 | 06455 KTK 006   |
| 06455 KR3 405 | 43150 KBE 3060    | 4310A BA4 000M1 |
| 43082 1238    | 43150 LLS 3050    | 59100 05820     |

### Competitor X Ref

|                        |                          |                   |               |
|------------------------|--------------------------|-------------------|---------------|
| <b>Dunlop</b><br>DP129 | <b>Ferodo</b><br>FDB2087 | <b>SBS</b><br>638 | <b>Vesrah</b> |
|------------------------|--------------------------|-------------------|---------------|

### ARCTIC CAT

|                       |    |   |
|-----------------------|----|---|
| DVX 50 (Y6)           | 06 | R |
| DVX 90 (Y12 4 Stroke) | 06 | R |

### CPI

|            |    |   |
|------------|----|---|
| 125 Prince | 01 | F |
|------------|----|---|

### DAELIM

|                    |       |   |
|--------------------|-------|---|
| Roadwin (VJ125)    | 04-07 | R |
| SQ 125 Freewing A2 | 06    | R |
| SQ 250 Freeway S2  | 06    | R |
| ET 250 Quad        | 06    | R |

### GARELLI

|           |    |     |
|-----------|----|-----|
| Tiger 125 | 07 | F&R |
|-----------|----|-----|

### HARTFORD

|                  |    |   |
|------------------|----|---|
| VR 125/150 H/X/Z | 04 | R |
|------------------|----|---|

### HERO

|              |    |   |
|--------------|----|---|
| Magellan 125 | 06 | F |
| Pluto 125    | 06 | F |

### YAMAHA

|                            |       |   |
|----------------------------|-------|---|
| TZR 50 Thunderkid (5DU1/3) | 97-00 | F |
| Crypton-R New 110cc        | 04    | F |

### KAWASAKI

|                                    |       |   |
|------------------------------------|-------|---|
| BN 125 A3/A4/A5/A6F/A7F Eliminator | 00-07 | F |
| Kaze-R New 112cc                   | 04    | F |

### KYMCO

|                             |       |          |
|-----------------------------|-------|----------|
| Activ 50/110/125            | 04-06 | F        |
| Bet & Win 50/Dink Sports 50 | 02-06 | F        |
| Dink 50/Spacer 50/Yager 50  | 98-07 | F        |
| Dink Classic 50 Euro 2      | 03    | F        |
| Super 9 50 (LC)             | 00-07 | F        |
| Super 9 (A/C) 50            | 00-07 | F        |
| Yager 50                    | 07    | F        |
| Bet & Win 125/150           | 00-06 | F&R      |
| Cruiser 125                 | 99    | F        |
| Dink 125/150/Spacer         | 97-04 | F&R      |
| Dink Classic 125/150        | 02    | F&R      |
| Dink LX 125/150             | 98-00 | F&R      |
| Grand Dink/Miler 125/150    | 01-07 | F&R      |
| Hipster 125/150             | 99-06 | F        |
| Movie XL 125/150            | 01-06 | F        |
| Quannon 125                 | 07    | F&R      |
| Sector 125                  | 99-01 | F        |
| Sector 125                  | 98-01 | F        |
| Spike 125 R                 | 04-06 | F&R      |
| Straight 125                | 05-06 | F        |
| Yager 125                   | 00    | F&R      |
| Yager GT 125                | 07    | F&R      |
| Zing 125/150 Custom Style   | 97-06 | F        |
| Bet & Win 250               | 00-06 | F&R      |
| People 250                  | 03-06 | F&R      |
| People 250 S                | 06    | F(right) |
| Yup 250                     | 03-06 | F        |

### MZ/MUZ

|        |       |     |
|--------|-------|-----|
| RT 125 | 02-07 | F&R |
| SM 125 | 02-07 | R   |
| SX 125 | 02-07 | R   |

### PGO

|           |       |   |
|-----------|-------|---|
| G Max 125 | 06-07 | R |
| G Max 250 | 06    | R |

### SYM

|               |       |   |
|---------------|-------|---|
| Shark 4VR-125 | 01-02 | R |
|---------------|-------|---|

### SUZUKI

|                   |    |          |
|-------------------|----|----------|
| FX 125            |    | F        |
| Shogun-R FD-112   | 04 | F        |
| AN 400 K7 Burgman | 07 | F(right) |

### WUYANG

|            |       |   |
|------------|-------|---|
| WY 125 24B | 06-07 | F |
|------------|-------|---|

### YAMAHA

|             |       |   |
|-------------|-------|---|
| XTZ 125 K/E | 05-06 | F |
| YBR 250     | 07    | F |

### MATERIAL AVAILABILITY AND PART NO.

| STD   | OPTIONS |   |     |     |
|-------|---------|---|-----|-----|
| FA    | HH      | R | MXS | GFA |
| FA197 | FA197HH | - | -   | -   |

# FA198 106 x 31.7 x 6mm

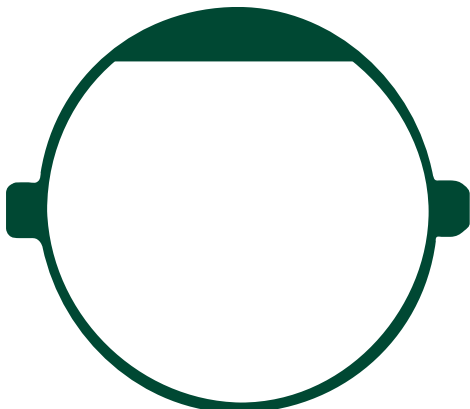

### CAGIVA

|              |       |   |
|--------------|-------|---|
| Roadster 125 | 96-97 | F |
|--------------|-------|---|

### CZ / JAWA

|                 |       |   |
|-----------------|-------|---|
| All Disc Models |       | F |
| 125 Travel      | 03-04 | F |
| 125 Chopper     | 03-04 | F |
| 350 Chopper     | 03-04 | F |
| 350 Tramp       | 03-04 | F |
| 350 Californian | 03-04 | F |

### Equivalents OE #

639 41 054

### Competitor X Ref

|               |               |            |               |
|---------------|---------------|------------|---------------|
| <b>Dunlop</b> | <b>Ferodo</b> | <b>SBS</b> | <b>Vesrah</b> |
| -             | -             | 699        | -             |

### MATERIAL AVAILABILITY AND PART NO.

| STD   | OPTIONS |   |     |     |
|-------|---------|---|-----|-----|
| FA    | HH      | R | MXS | GFA |
| FA198 | -       | - | -   | -   |

# FA199 93.8 x 40.3 x 9.8mm

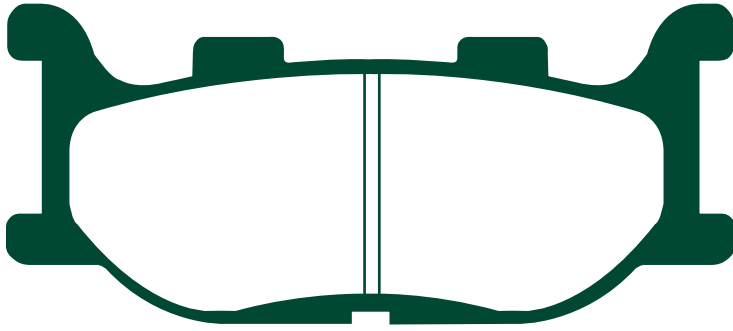

**Equivalents OE #**

|              |              |
|--------------|--------------|
| 4GA W0045 00 | 5VX W0045 00 |
| 4HM W0045 00 | 5VH W0045 00 |
| 4EB W0045 00 | 5VU W0045 00 |
| 4716630      |              |

**Competitor X Ref**

| Dunlop | Ferodo  | SBS | Vesrah |
|--------|---------|-----|--------|
| DP421  | FDB2003 | 691 | VD-260 |

**YAMAHA**

|   |       |   |
|---|-------|---|
| TDR 125 R                                   | 93-03 | F |
| XV 125 'Virago'                             | 97-00 | F |
| XVS 125 Dragstar                            | 00-03 | F |
| SR 125                                      | 97-03 | F |
| TZR 150 R (4AP2)                            | 00    | F |
| XV 250 S 'Virago'                           | 95-00 | F |
| XVS 250 Dragstar                            | 01-04 | F |
| YP 250 DX/A/Majesty                         | 98-03 | F |
| YP 400 T/V/W Majesty                        | 05-07 | F |
| XJR 400 (4HM3/4HM5/4HM6<br>/4HM9/4HMA/4HMB) |       |   |
| Brembo calipers                             | 95-99 | F |
| XP 500 T-Max (5VU1/2)                       | 04-07 | F |
| FZ6 Fazer/Fazer A                           | 04-07 | F |
| FZ6 (Naked version)                         | 04-07 | F |
| XJ 600 S/N                                  | 98-03 | F |
| MT03V (660cc)                               | 06-07 | F |
| XV 1100 Virago                              | 99    | F |
| XVS 1100 Dragstar                           | 99-04 | F |
| XVS 1100 A Dragstar Classic                 | 00-07 | F |
| XVS 1300 A Midnight Star                    | 07    | F |

**ITALJET**

|                 |       |   |
|-----------------|-------|---|
| Jupiter 125/150 | 02    | F |
| Jupiter 250     | 02-03 | F |

**MBK**

|                            |       |   |
|----------------------------|-------|---|
| YP 250 Skyliner            | 96-99 | F |
| YP 250 Skyliner 250 (+ABS) | 00-02 | F |
| YP 400 Skyliner            | 04    | F |

**MATERIAL AVAILABILITY AND PART NO.**

| STD   | OPTIONS |   |     |     |
|-------|---------|---|-----|-----|
| FA    | HH      | R | MXS | GFA |
| FA199 | FA199HH | - | -   | -   |

# FA200 104 x 62.4 x 11.2mm

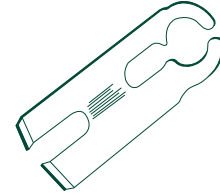
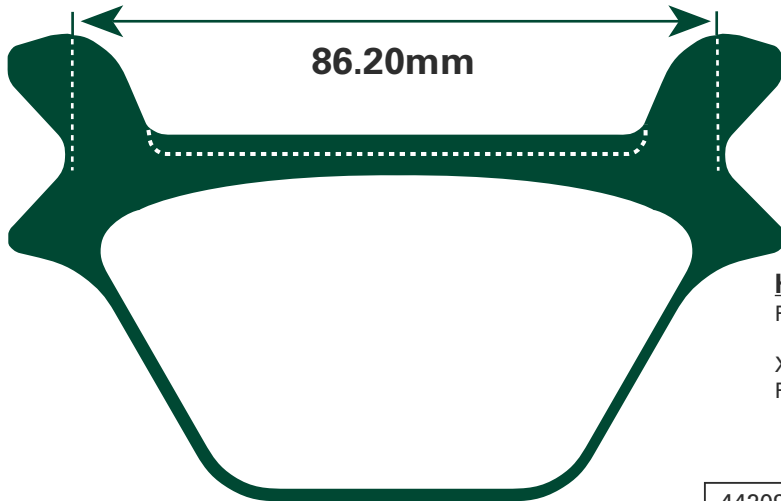

**Abutment Shims  
(2 per set)**

**HARLEY DAVIDSON**

|   |            |   |
|---|------------|---|
| FXST/FXSTB/FXSTC/FXSTS/FLST/<br>FLSTC/FLSTF/FLSTS/FLSTN | Late 87-89 | R |
| XL/XLH/XLCH/XLS/XLX                                     | Late 87-99 | R |
| FXD/FXDL/FXDWG/FXR/FXRS/FXRT<br>/FXRD/FXLR/FXDX         | Late 87-99 | R |

**Equivalents OE #**

|           |           |          |
|-----------|-----------|----------|
| 44209 87B | 44209 87C | 44213 87 |
|-----------|-----------|----------|

**Competitor X Ref**

| Dunlop | Ferodo      | SBS | Vesrah |
|--------|-------------|-----|--------|
| DP905  | FDB521/2001 | 669 | VD-923 |

**MATERIAL AVAILABILITY AND PART NO.**

| STD   | OPTIONS |   |     |     |
|-------|---------|---|-----|-----|
| FA    | HH      | R | MXS | GFA |
| FA200 | FA200HH | - | -   | -   |

# FA201 104 x 62.4 x 11.4mm

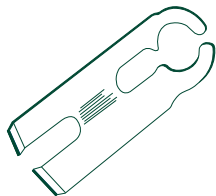
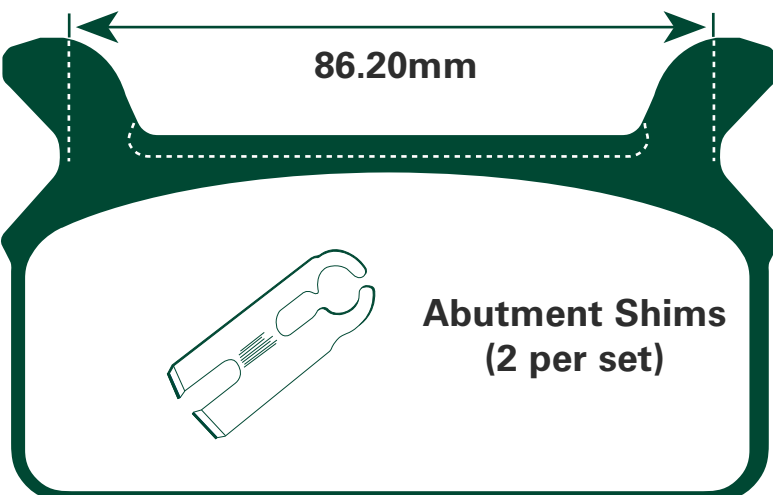

**Abutment Shims  
(2 per set)**

**HARLEY DAVIDSON**

|                        |       |   |
|------------------------|-------|---|
| FLT/FLHT/FLHTCI/FLTCUI | 86-99 | R |
| FLHR/FLHRCI/FLTRI      | 94-99 | R |

**Equivalents OE #**

|           |           |
|-----------|-----------|
| 43957 86  | 43957 86B |
| 43957 86A | 43957 86D |

**Competitor X Ref**

| Dunlop | Ferodo | SBS | Vesrah |
|--------|--------|-----|--------|
| DP904  | FDB485 | 668 | VD-922 |

**MATERIAL AVAILABILITY AND PART NO.**

| STD   | OPTIONS |   |     |     |
|-------|---------|---|-----|-----|
| FA    | HH      | R | MXS | GFA |
| FA201 | FA201HH | - | -   | -   |

**FA202 A. 96.7 x 43.4 x 7.6mm B. 77 x 43.4 x 8mm**

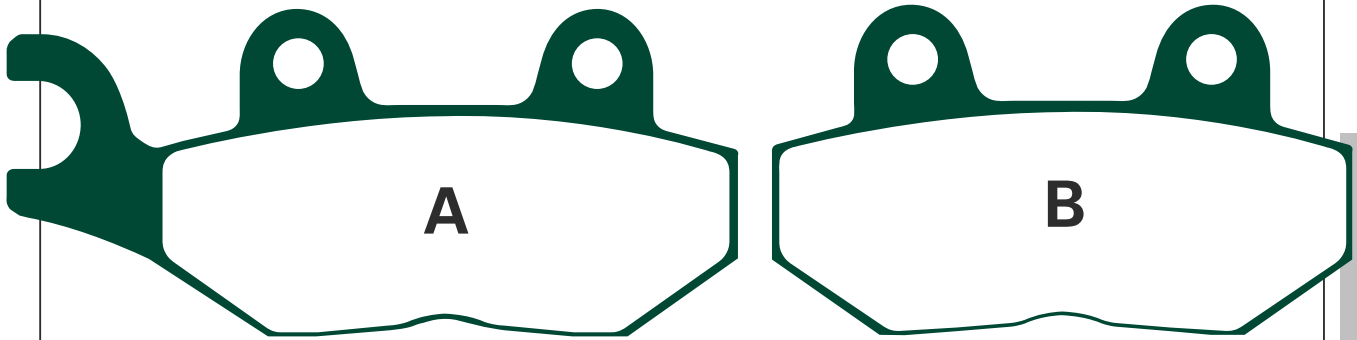

**FA202 Oversize Version of FA135  
See FA135 For Fitments**

Equivalents OE #

N/A

Competitor X Ref

| Dunlop | Ferodo | SBS | Vesrah |
|--------|--------|-----|--------|
| -      | -      | -   | -      |

**MATERIAL AVAILABILITY AND PART NO.**

| STD   | OPTIONS |        |     |     |
|-------|---------|--------|-----|-----|
| FA    | HH      | R      | MXS | GFA |
| FA202 | -       | FA202R | -   | -   |

**FA203 81.2 x 42 x 9.5mm**

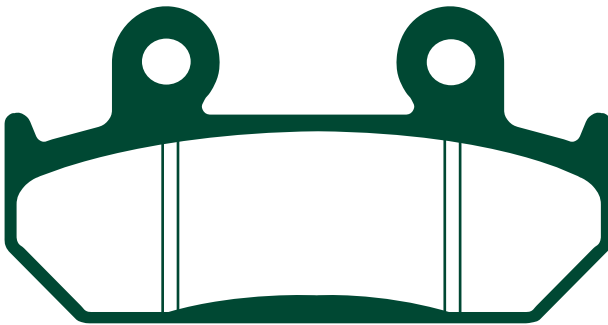

**HONDA**

CBR 600 FM/FN/FP/FR

91-94 F

Equivalents OE #

45105 MV1 008  
45105 MV1 405

Competitor X Ref

| Dunlop | Ferodo | SBS | Vesrah |
|--------|--------|-----|--------|
| DP110  | FDB462 | 593 | VD142  |

**MATERIAL AVAILABILITY AND PART NO.**

| STD   | OPTIONS |   |     |          |
|-------|---------|---|-----|----------|
| FA    | HH      | R | MXS | GFA      |
| FA203 | FA203HH | - | -   | GFA203HH |

**FA206 39.8 x 53.7 x 6.4mm**

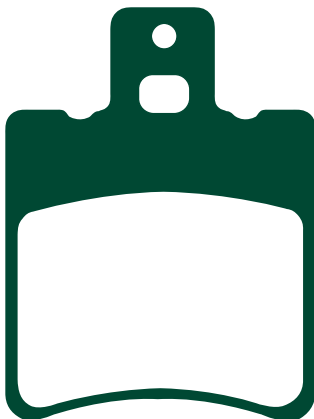

**USE FA193**

# FA208 78.13 x 41.2 x 9mm



1 Left/1Right

DISC PADS  
BUYERS GUIDE

|                                  |       |   |
|----------------------------------|-------|---|
| <b>ALFER</b>                     |       |   |
| VRE 125 4T                       | 98-   | R |
| Divertida 250 Super Motard       | 01-   | R |
| Diferente Enduro                 | 01-   | R |
| VR 250                           | 98-   | R |
| <b>APRILIA</b>                   |       |   |
| 650 ie                           | 01-04 | R |
| <b>BENELLI</b>                   |       |   |
| BX 450                           | 07    | R |
| <b>BORILE</b>                    |       |   |
| B 500 CR                         | 02-04 | R |
| B 500 MT                         | 02    | R |
| <b>CCM</b>                       |       |   |
| 404 E                            | 03-04 | R |
| 404 DS                           | 03-04 | R |
| 404 DS Supermoto                 | 03-04 | R |
| 644 DS Supermoto                 | 04    | R |
| 644 DS                           | 04    | R |
| R 30 (Spoke & Mag)               | 02-04 | R |
| R 35/R35S                        | 06    | R |
| <b>FACTORY</b>                   |       |   |
| YR 250                           | 03    | R |
| <b>CCM</b>                       |       |   |
| 604E Dual Sport/Supermoto/RS     | 98-03 | R |
| 604E R30                         | 02-04 | R |
| <b>GAS GAS</b>                   |       |   |
| EC 125/250/300/200 Enduro        | 97-99 | R |
| Enforcer four 400/501/600 2 Quad | 99    | F |
| Enduros 125/250                  | 00    | R |
| <b>HIGHLAND</b>                  |       |   |
| 950 V2 Outback                   | 00-04 | R |
| 950 V2 Motard                    | 00-04 | R |
| <b>HONDA HM (Italy)</b>          |       |   |
| FS 550 E Supermoto               | 05-07 | R |
| FS 650 E Supermoto               | 05-07 | R |
| <b>HRD</b>                       |       |   |
| GS 50                            |       | R |
| <b>HUSABERG</b>                  |       |   |
| FE 450 E                         | 06-07 | R |
| FS 450 E                         | 06    | R |
| FS 450 R                         | 06    | R |
| FE 550 E                         | 06-07 | R |
| FE 650 E                         | 06-07 | R |
| FS 650 C                         | 06-07 | R |
| <b>HUSQVARNA</b>                 |       |   |
| CR 125                           | 95-04 | R |
| SM 125 S Supermotard             | 98-07 | R |
| SM 125 S                         | 02-07 | R |
| SM 125                           | 98-00 | R |
| WRE 125                          | 93-07 | R |
| WR 125                           | 95-05 | R |
| WR/WRE 125 Dual                  | 00-07 | R |
| SM 610                           | 05    | R |
| CR 250                           | 95-04 | R |
| TE 250                           | 02-05 | R |
| TC 250                           | 02-04 | R |
| WR 250                           | 92-05 | R |
| TE 350                           | 95-97 | R |
| WR 360                           | 95-03 | R |
| SM 400 R                         | 02    | R |
| TE 400                           | 01-02 | R |
| TE 410 E                         | 00    | R |
| TE 410                           | 95-00 | R |
| SM 450 R                         | 03-06 | R |
| TC 450                           | 02-04 | R |
| TE 450                           | 02-05 | R |
| TC/TE 510                        | 04-05 | R |
| SM 510 R                         | 05-06 | R |
| SM 570 R                         | 01-04 | R |
| TC/TE 570                        | 01-04 | R |
| TE 570                           | 01-04 | R |
| TC/TE 610 E                      | 95-04 | R |
| LT 610                           | 00-01 | R |
| SMR 630                          | 05    | R |
| SM 610                           | 98-00 | R |
| SM 610 R                         | 00    | R |

## HUSQVARNA Contd.

|  |       |   |
|--|-------|---|
| SM 610 R/IE                                    | 05-07 | R |
| SM 610 S (Radial caliper)                      | 06    | R |
| SM 610 S (4 bolt front disc)                   | 02-06 | R |
| SM 610 ie                                      | 07    | R |
| TC 610   | 00    | R |
| TC 610 E                                       | 95-99 | R |
| TE 610   | 00    | R |
| TE 610 E                                       | 95-03 | R |
| TE 610 IE                                      | 06-07 | R |
| SMR 630  | 06    | R |
| STR 650 CRC                                    | 07    | R |
| <b>KRAM-IT (KRAMER)</b>                        |       |   |
| GS 250   | 00-   | R |
| SM 250   | 00-   | R |
| SMR 250  | 00-   | R |
| <b>KTM</b>                                     |       |   |
| LC2 125  | 96-98 | R |
| Sting 125                                      | 97-99 | R |
| SX 125   | 94-03 | R |
| EXC/EGS 125                                    | 94    | R |
| EXC 125  | 95-03 | R |
| EXC/EGS 200                                    | 98-03 | R |
| SM 125 Supermoto                               | 00    | R |
| EXE 125  | 00    | R |
| EXC 200  | 98-03 | R |
| SX 250   | 94-02 | R |
| EXC/EGS 250                                    | 94    | R |
| EXC 250  | 95-03 | R |
| EXC 300  | 00-03 | R |
| EXC 350  | 94-95 | R |
| SX 360   | 96-97 | R |
| EXC 360  | 96-97 | R |
| SX 380   | 98-03 | R |
| EXC 380  | 98-03 | R |
| Duke 400 LC4                                   | 94-98 | R |
| SC 400   | 96-99 | R |
| EGS/EGS-3/LSE 400                              | 96-99 | R |
| SX 400   | 00-02 | R |
| EXC/EGS 400 (USD)                              | 00-02 | R |
| EXC 400 Racing (USD)                           | 00    | R |
| LC4-E 400 Enduro                               | 00-01 | R |
| SX 440   | 94-95 | R |
| EXC 440  | 94-95 | R |
| EXC 450  | 03    | R |
| MX 500   | 95    | R |
| EXC 525  | 03    | R |
| SX 520   | 01-03 | R |
| EXC 520  | 01-03 | R |
| MXC 525 (Desert Racing)                        | 03-04 | R |
| MXC 550  | 96    | R |
| Duke 620 LC4                                   | 94-98 | R |
| SX EXC/EGS 620                                 | 95    | R |
| SX 620   | 96-99 | R |
| SC 620 Supercompetition                        | 96-00 | R |
| EGS/EGS-E/LSE 620 Enduro                       | 96-99 | R |
| EGS-E 620 Adventure/Rallye                     | 99    | R |
| LC4 620 SC Supermoto/Supercompetition          | 00    | R |
| LC4 625 SC Supermoto                           | 02    | R |
| SMC 625  | 05    | R |
| SXC 625  | 03-04 | R |
| Duke II 640 (All models)                       | 01-06 | R |
| LC4-E 640 Enduro/Supermoto/Adventure R         | 00-06 | R |
| LC4 640 Adventure                              | 01-06 | R |
| SM 640 LC4                                     | 05    | R |
| 640 LC4 Adventure                              | 03-07 | R |
| SMC 660 Supermoto                              | 03-04 | R |
| SMC 660  | 05-06 | R |
| 690 Supermoto                                  | 07    | R |
| 690 SM Prestige                                | 07    | R |
| 990 Superduke                                  | 05-07 | R |
| 990 Superduke R                                | 07    | R |
| <b>MAICO</b>                                   |       |   |
| 500 MX/Enduro                                  | 99    | R |
| <b>TM</b>                                      |       |   |
| 80 Enduro                                      | 96-00 | R |
| 80/85 Cross                                    | 96-01 | R |
| 80/85/100 (Big wheel)                          | 02-04 | R |
| Junior 80/85/100 Cross (Small wheel)           | 02-04 | R |
| 125 Cross                                      | 95-00 | R |
| 125 Enduro                                     | 95-00 | R |
| 250 Cross                                      | 95-00 | R |
| 250 Enduro                                     | 95-00 | R |
| 300 Cross                                      | 95-00 | R |
| 300 Enduro (2T)                                | 95-00 | R |
| 400 Cross (4T)                                 | 95-00 | R |
| 530 Cross (4T)                                 | 98-00 | R |
| <b>VERTEMATI</b>                               |       |   |
| All models                                     | 99-04 | R |
| <b>VOR</b>                                     |       |   |
| All models                                     | 99-04 | R |
| <b>YAMAHA</b>                                  |       |   |
| TT 600 R (5CH1/5CH2/5CH3)                      | 97-02 | R |
| TT 600 RE (5CH5)                               | 04    | R |
| TT 600 E (4LW3/4LW4/4GV4/4GV5)                 | 94-01 | R |
| TT 600 K From 4GV 003404 (Brembo rear caliper) | 95-96 | R |

### Competitor X Ref

| Dunlop | Ferodo  | SBS | Vesrah |
|--------|---------|-----|--------|
| DP622  | FDB2019 | 675 | VD-953 |

### Equivalent OE #

|           |                |              |
|-----------|----------------|--------------|
| 800079072 | AB040 S        | 211021038    |
| 8A0079072 | 546 13 309 200 | 4GV FS811 00 |
| 8113538   | 546 13 309 300 |              |
| AB040     | 546 13 309 400 |              |

### MATERIAL AVAILABILITY AND PART NO.

| STD     | OPTIONS |        |        |          |
|---------|---------|--------|--------|----------|
| FA      | HH      | R      | MXS    | GFA      |
| FA208TT | -       | FA208R | MXS208 | GFA208HH |

# FA209 Use FA209/2

## FA209/2 108.9 x 41.3 x 7.6mm

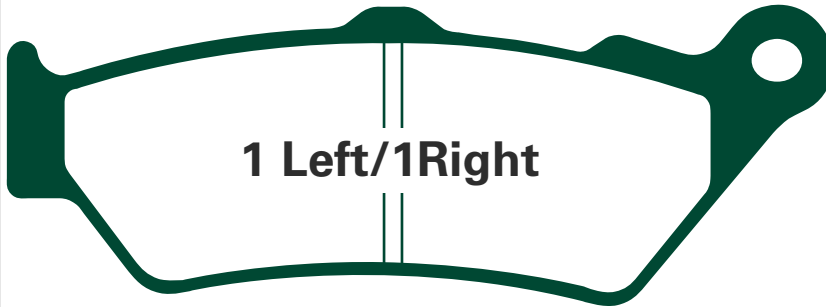

### Equivalents OE # - FA209/2

|                |                 |                 |
|----------------|-----------------|-----------------|
| 06455 MAK 000  | 34 11 2 345 445 | 5VK W0045 00    |
| 06455 MAN 911  | 8113533         | 600 13 0300 000 |
| 06455 MY5 731  | 34 11 7 660 340 | 2C8 W0045 00    |
| 06455 MAK 003  | 34 117 651 958  | 8133906         |
| 0000 365 46000 | 2202491         | 000306546260    |

### Competitor X Ref

| Dunlop | Ferodo  | SBS | Vesrah |
|--------|---------|-----|--------|
| DP623  | FDB2006 | 674 | VD958  |

### MATERIAL AVAILABILITY AND PART NO.

| STD     | OPTIONS   |   |     |            |
|---------|-----------|---|-----|------------|
| FA      | HH        | R | MXS | GFA        |
| FA209/2 | FA209/2HH | - | -   | GFA209/2HH |

### APRILIA

|                            |       |   |
|----------------------------|-------|---|
| Moto 6.5                   | 95-01 | F |
| Pegaso 650/650 IE          | 97-04 | F |
| Pegaso 650 Trial           | 06-07 | F |
| ETV 1000 Caponard/Raid/ABS | 01-07 | F |

### BMW

|                   |       |   |
|-------------------|-------|---|
| C1 125            | 99-03 | F |
| C1 200            | 01-03 | F |
| F 650/650 ST      | 93-00 | F |
| F 650 GS/Dakar GS | 93-07 | F |
| F 650 CS/Scarver  | 00-06 | F |
| G 650 Xchallenge  | 07    | F |
| G 650 Xcountry    | 07    | F |
| HP2 1200 Enduro   | 05-07 | F |

### HONDA

|                                |       |   |
|--------------------------------|-------|---|
| CB 500 V/W/SW/X/SX/Y/SY/2/S2   | 97-03 | F |
| NX 500 V/W/X Dominator         | 97-99 | F |
| SRL 650 V/W                    | 97-98 | F |
| NT 650 VW/XV/XY/V1 'Deauville' | 98-01 | F |
| NX 650 V/W/X Dominator         | 97-02 | F |
| FX 650 X/Y 'Vigor'             | 99-03 | F |

### ITALJET

|              |    |   |
|--------------|----|---|
| Griffon # 59 | 07 | R |
|--------------|----|---|

### KTM

|                   |       |   |
|-------------------|-------|---|
| 950 Adventure/S   | 04-06 | F |
| 990 Adventure/S   | 06-07 | F |
| 950 R Superenduro | 06    | F |

### MOTO GUZZI

|                                       |       |   |
|---------------------------------------|-------|---|
| Breva 850                             | 07    | R |
| Norge 850                             | 07    | R |
| Griso 860                             | 07    | R |
| 940 Custom                            | 07    | R |
| Quota 1100 ES                         | 99-00 | F |
| California/EV/Special                 | 99    | R |
| California EV 1100                    | 99-00 | R |
| California Classic 1100               | 07    | R |
| Breva V1100                           | 05    | R |
| Breva 1100 (ABS)                      | 07    | R |
| Griso 1100                            | 05-07 | R |
| Griso 1100 (8 valve) (Radial caliper) | 07    | R |
| Breva 1100                            | 05-06 | R |
| Norge 1200                            | 06-07 | R |
| 1200 Sport                            | 07    | R |

### TRIUMPH

|                    |       |   |
|--------------------|-------|---|
| Rocket 111 2300cc  | 04-07 | R |
| Rocket 111 Classic | 07    | R |

### VICTORY

|                    |       |   |
|--------------------|-------|---|
| Victory All models | 98-07 | R |
|--------------------|-------|---|

### YAMAHA

|          |       |   |
|----------|-------|---|
| DT 125 X | 05-06 | F |
| XT 660 R | 04-07 | F |

# FA210 112.1 x 56.3 x 10.0mm

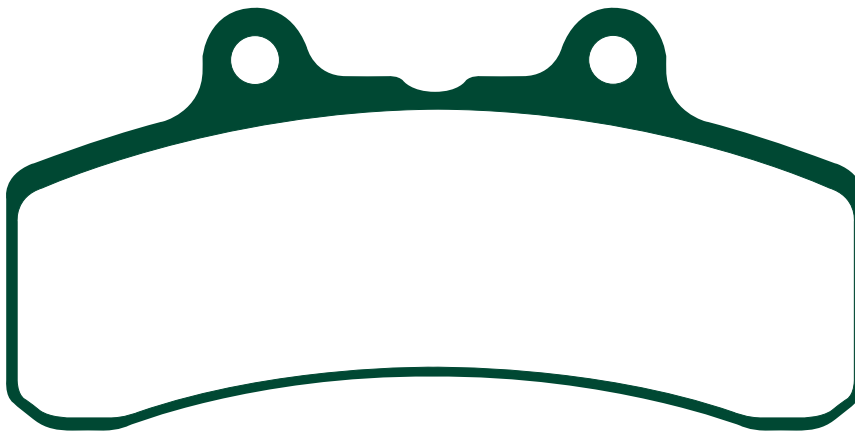

### BUELL

|                  |       |   |
|------------------|-------|---|
| M2 Cyclone       | 94-97 | F |
| S2 "Thunderbolt" | 94-97 | F |
| S1 Lightning     | 94-97 | F |
| S3 Thunderbolt   | 94-97 | F |

### PERFORMANCE MACHINE

125X6  
137X6

### Equivalents OE #

|           |
|-----------|
| 42386 84Y |
| 0053 1604 |

### Competitor X Ref

| Dunlop | Ferodo | SBS | Vesrah |
|--------|--------|-----|--------|
| DP912  | FDB847 | 658 | -      |

### MATERIAL AVAILABILITY AND PART NO.

| STD   | OPTIONS |   |     |     |
|-------|---------|---|-----|-----|
| FA    | HH      | R | MXS | GFA |
| FA210 | -       | - | -   | -   |

**FA211 77.8 x 45.4 x 8.5mm**  
**FA211/2 77.8 x 45.4 x 10.4mm**

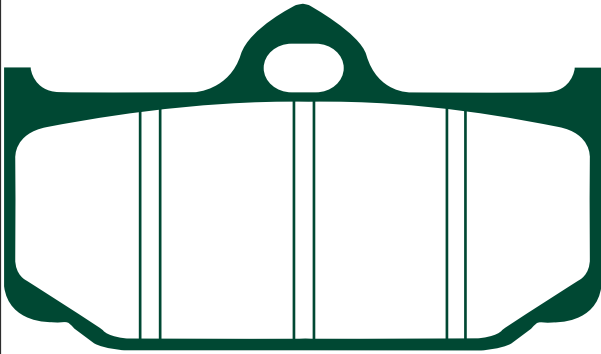

**Competitor X Ref**

| Dunlop | Ferodo   | SBS | Vesrah |
|--------|----------|-----|--------|
| -      | FDB 2008 | -   | -      |

**FA211/2 - PVM**  
4 Piston Race Caliper

**Equivalents OE #**

N/A

| MATERIAL AVAILABILITY AND PART NO. |         |   |     |     |
|------------------------------------|---------|---|-----|-----|
| STD                                | OPTIONS |   |     |     |
| FA                                 | HH      | R | MXS | GFA |
| FA211                              | -       | - | -   | -   |

| MATERIAL AVAILABILITY AND PART NO. |         |   |     |     |
|------------------------------------|---------|---|-----|-----|
| STD                                | OPTIONS |   |     |     |
| FA                                 | HH      | R | MXS | GFA |
| FA211/2                            | -       | - | -   | -   |

**FA213 78.13 x 41.2 x 9mm**



**1 Left/1Right**

**Equivalents OE #**

|                 |                 |           |
|-----------------|-----------------|-----------|
| 06435 MAK 003   | 34 21 7 664 983 | 8133825   |
| 34 21 7 660 343 | 34 21 2 345 449 | 61340761A |
| 34 21 7 660 253 | 5VK W0046 00    | 8133911   |

**Competitor X Ref**

| Dunlop | Ferodo | SBS | Vesrah |
|--------|--------|-----|--------|
| -      | -      | -   | -      |

**APRILIA**

|                    |       |   |
|--------------------|-------|---|
| Pegaso Strada 650  | 05-06 | R |
| Pegaso 650 Trial   | 06    | R |
| Pegaso 650 Factory | 07    | R |
| Pegaso 650         | 07    | R |
| SL 750 Shiver      | 07    | R |
| NA 850 Mana        | 07    | R |

**BETA**

|              |       |   |
|--------------|-------|---|
| Jonathan 125 | 00-01 | R |
| Euro 350     | 00-01 | R |

**BMW**

|                   |       |   |
|-------------------|-------|---|
| C1 125            | 99-03 | R |
| C1 200            | 01-03 | R |
| F 650/650 ST      | 93-00 | R |
| F 650 GS/Dakar GS | 93-06 | R |
| F 650 CS/Scarver  | 00-06 | R |
| G 650 Xchallenge  | 07    | R |
| G 650 Xmoto       | 07    | R |
| G 650 Xcountry    | 07    | R |
| F800 S/ST         | 06-07 | R |

**CCM**

|                        |    |   |
|------------------------|----|---|
| CR 40 S Cafe Racer     | 07 | R |
| CF 40 Street           | 07 | R |
| SR 40 Street Scrambler | 07 | R |

**DUCATI**

|                               |       |   |
|-------------------------------|-------|---|
| Paul Smart 1000 Limited       | 06-07 | R |
| GT 1000 (992cc)               | 06-07 | R |
| 1000 Sport (992cc)            | 06-07 | R |
| Classic Sport Biposto (992cc) | 07    | R |
| Sport 1000 S (992cc)          | 07    | R |

**HONDA**

|                              |       |   |
|------------------------------|-------|---|
| CB 500 V/W/SW/X/SX/Y/SY/2/S2 | 97-03 | R |
| NX 500 V/W/X Dominator       | 97-99 | R |
| FX 650 X/Y "Vigor"           | 99-03 | R |
| SLR 650 V/W                  | 97-98 | R |
| NX 650 V/W/X Dominator       | 97-99 | R |

**YAMAHA**

|                    |       |   |
|--------------------|-------|---|
| XT 660 X Supermoto | 04-07 | R |
| XT 660 R           | 04-07 | R |
| MT03V (660cc)      | 06-07 | R |

| MATERIAL AVAILABILITY AND PART NO. |         |   |     |     |
|------------------------------------|---------|---|-----|-----|
| STD                                | OPTIONS |   |     |     |
| FA                                 | HH      | R | MXS | GFA |
| FA213                              | FA213HH | - | -   | -   |

**FA214 A. 96.7 x 42 x 7.6mm B. 77.3 x 42 x 8mm**

**FA214/2 A. 96.7 x 42 x 9.7mm B. 77.3 x 42 x 8mm**

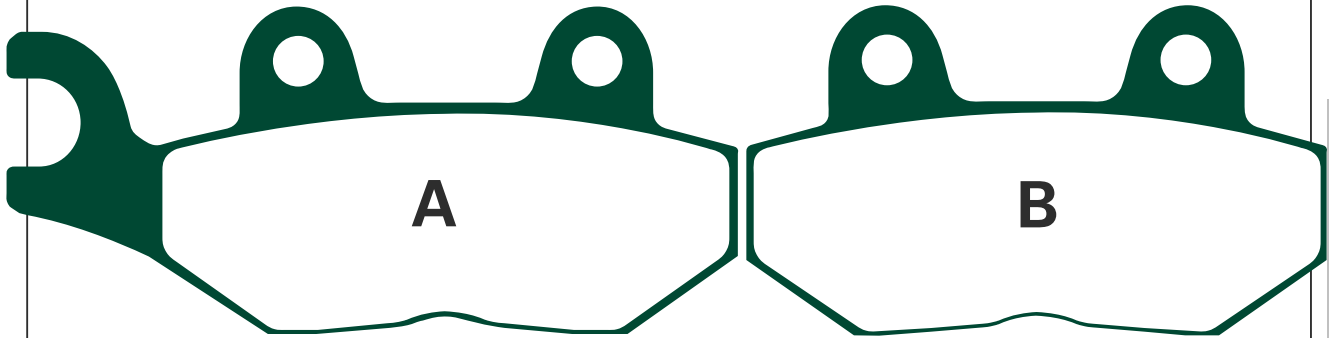

**DISC PADS  
BUYERS GUIDE**

**TRIUMPH**

|                          |       |         |
|--------------------------|-------|---------|
| Sprint (All carb models) | 93    | F(Left) |
| Tiger 885cc              | 92-97 | F(Left) |
| Trident 750              | 92-98 | F(Left) |
| Trident 900              | 92-98 | F(Left) |
| Trophy 900               | 92-93 | F(Left) |
| Trophy 1200              | 92-93 | F(Left) |

**FA214/2 - TRIUMPH**

|                                     |       |   |
|-------------------------------------|-------|---|
| America (Cast wheel)                | 07    | R |
| Bonneville America                  | 02-06 | R |
| Bonneville 800                      | 01-06 | R |
| Bonneville T100                     | 02-06 | R |
| Bonneville/Bonneville Black (865cc) | 07    | R |
| T595 Daytona                        | 97    | R |
| Daytona 650                         | 05    | R |
| Daytona 955i                        | 98-00 | R |
| Daytona 955i                        | 05-06 | R |
| Speed Triple                        | 97-01 | R |
| Speed Triple 955cc                  | 02-04 | R |
| Sprint RS                           | 99-04 | R |
| Thruxton 900                        | 04-07 | R |
| Scrambler (865cc)                   | 06-07 | R |
| Speedmaster 800                     | 03-04 | R |
| Speedmaster (865cc)                 | 05-07 | R |
| Sprint ST (1050cc)                  | 05-06 | R |
| Speed Triple (1050cc)               | 05-07 | R |
| Tiger 1050 (Radial caliper)         | 07    | R |

**Competitor X Ref**

| Dunlop | Ferodo | SBS | Vesrah |
|--------|--------|-----|--------|
| DP411  | FDB497 | 638 | VD340  |

**Equivalents OE #** FA214 = T 2020071 T301

**Equivalents OE #**

|                          |                      |
|--------------------------|----------------------|
| FA214/2 = T 2020 555     | FA214/2 = T 2020 556 |
| FA214/2 = T 2020 072 T31 | FA214/2 = T 2020 191 |

| MATERIAL AVAILABILITY AND PART NO. |         |   |     |     |
|------------------------------------|---------|---|-----|-----|
| STD                                | OPTIONS |   |     |     |
| FA                                 | HH      | R | MXS | GFA |
| FA214                              | FA214HH | - | -   | -   |

| MATERIAL AVAILABILITY AND PART NO. |           |   |     |     |
|------------------------------------|-----------|---|-----|-----|
| STD                                | OPTIONS   |   |     |     |
| FA                                 | HH        | R | MXS | GFA |
| FA214/2                            | FA214/2HH | - | -   | -   |

**FA215 A. 96.7 x 42 x 7.6mm B. 77.3 x 42 x 8mm**

**FA215/2 A. 96.7 x 42 x 9.7mm B. 77.3 x 42 x 8mm**

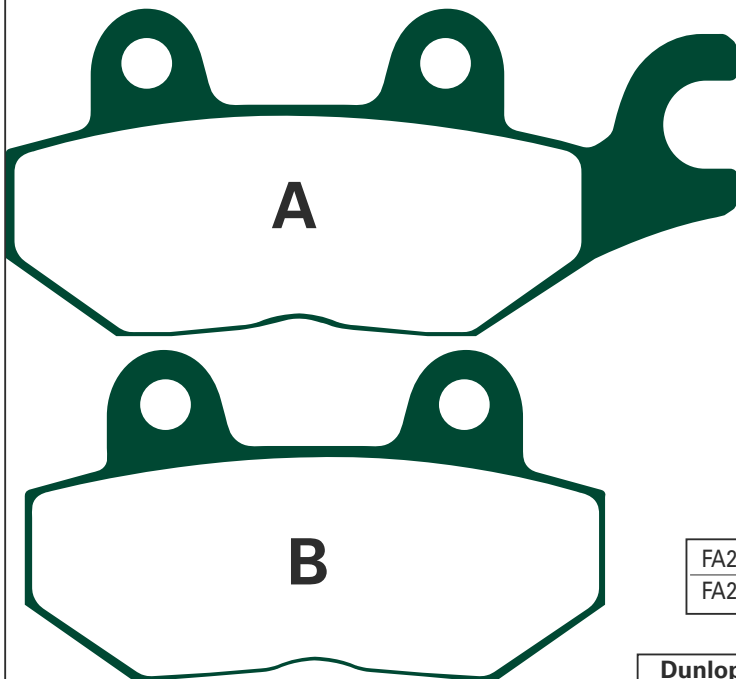

**TRIUMPH - FA215**

|             |       |          |
|-------------|-------|----------|
| Sprint      | 93    | F(Right) |
| Trident 750 | 92-98 | F(Right) |
| Tiger 885cc | 92-97 | F(Right) |
| Trident 900 | 92-98 | F(Right) |
| Trophy 900  | 92-93 | F(Right) |
| Trophy 1200 | 92-93 | F(Right) |

**FA215/2 - TRIUMPH**

|                            |       |   |
|----------------------------|-------|---|
| Daytona 750                | 92    | R |
| Daytona 1000               | 92    | R |
| Daytona 900                | 93-96 | R |
| Daytona Super III          | 94-97 | R |
| Daytona 1200               | 93-98 | R |
| Speed Triple               | 94-97 | R |
| Sprint                     | 93-98 | R |
| Sprint RS                  | 99-02 | R |
| Trident 750                | 92-98 | R |
| Tiger 885cc                | 92-97 | R |
| Trident 900                | 92-98 | R |
| Trophy 900                 | 92-01 | R |
| Tiger 955 (from VIN198875) | 04-06 | R |
| Trophy 1200                | 92-01 | R |

**Equivalents OE #**

|                        |                     |
|------------------------|---------------------|
| FA215 = T 2020072-T301 | FA215/2 = T 2020561 |
| FA215/2 = T 2020560    |                     |

**Competitor X Ref**

| Dunlop | Ferodo | SBS | Vesrah      |
|--------|--------|-----|-------------|
| DP412  | FDB631 | 611 | VD250/250/2 |

| MATERIAL AVAILABILITY AND PART NO. |         |   |     |     |
|------------------------------------|---------|---|-----|-----|
| STD                                | OPTIONS |   |     |     |
| FA                                 | HH      | R | MXS | GFA |
| FA215                              | FA215HH | - | -   | -   |

| MATERIAL AVAILABILITY AND PART NO. |           |   |     |     |
|------------------------------------|-----------|---|-----|-----|
| STD                                | OPTIONS   |   |     |     |
| FA                                 | HH        | R | MXS | GFA |
| FA215/2                            | FA215/2HH | - | -   | -   |

**FA216** 69.2 x 48.8 x 8.3mm  
**FA216/2** 69.2 x 48.8 x 10.5mm  
**FA216/3** 69.2 x 48.8 x 7.8mm

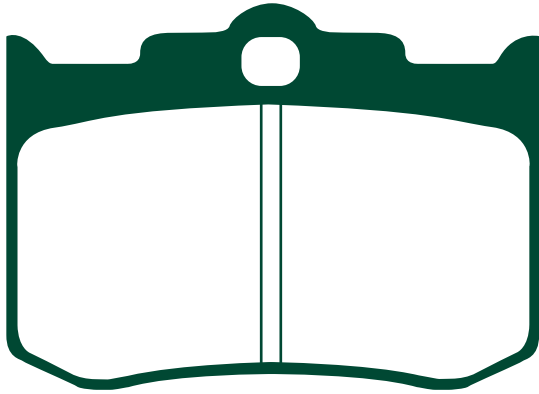

**Competitor X Ref**

|                        |                            |                       |                    |
|------------------------|----------------------------|-----------------------|--------------------|
| <b>Dunlop</b><br>DP911 | <b>Ferodo</b><br>FDB2040/H | <b>SBS</b><br>678/662 | <b>Vesrah</b><br>- |
|------------------------|----------------------------|-----------------------|--------------------|

**FA216**

INDIAN - See page for application details  
**PERFORMANCE MACHINE** - 125X4R  
 125X4RSPH  
 137X4B

**FA216/2**

EBC 4 Piston Race Caliper  
**PERFORMANCE MACHINE**  
 124X4HR  
 137X4

**FA216/3**

Nova  
 Legends  
 Thunderheart

| MATERIAL AVAILABILITY AND PART NO. |         |   |     |          |
|------------------------------------|---------|---|-----|----------|
| STD                                | OPTIONS |   |     |          |
| FA                                 | HH      | R | MXS | GFA      |
| FA216                              | FA216HH | - | -   | GFA216HH |

| MATERIAL AVAILABILITY AND PART NO. |         |   |     |     |
|------------------------------------|---------|---|-----|-----|
| STD                                | OPTIONS |   |     |     |
| FA                                 | HH      | R | MXS | GFA |
| FA216/2                            | -       | - | -   | -   |

| MATERIAL AVAILABILITY AND PART NO. |           |   |     |     |
|------------------------------------|-----------|---|-----|-----|
| STD                                | OPTIONS   |   |     |     |
| FA                                 | HH        | R | MXS | GFA |
| FA216/3                            | FA216/3HH | - | -   | -   |

**FA217** 106 x 31.7 x 8.5mm

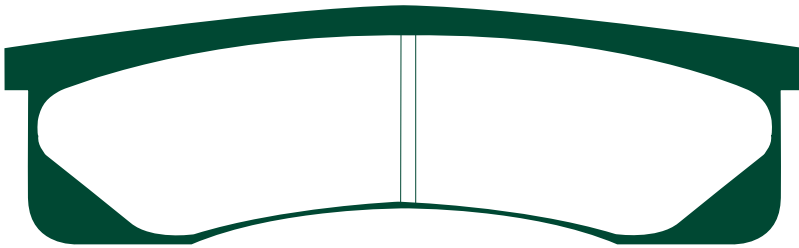

**Competitor X Ref**

|                    |                         |                   |                    |
|--------------------|-------------------------|-------------------|--------------------|
| <b>Dunlop</b><br>- | <b>Ferodo</b><br>FRP418 | <b>SBS</b><br>660 | <b>Vesrah</b><br>- |
|--------------------|-------------------------|-------------------|--------------------|

**Wilwood 6 Piston Caliper**  
**Lockheed 6 Piston Caliper**  
 (3366/67 Type)

**RACE USE ONLY**

**Equivalents OE #**

N/A

| MATERIAL AVAILABILITY AND PART NO. |         |   |     |     |
|------------------------------------|---------|---|-----|-----|
| STD                                | OPTIONS |   |     |     |
| FA                                 | HH      | R | MXS | GFA |
| FA217                              | -       | - | -   | -   |



# FA218 77.65 x 40.50 x 8.5mm

Race use only

# FA218/2 77.65 x 40.50 x 10.40mm

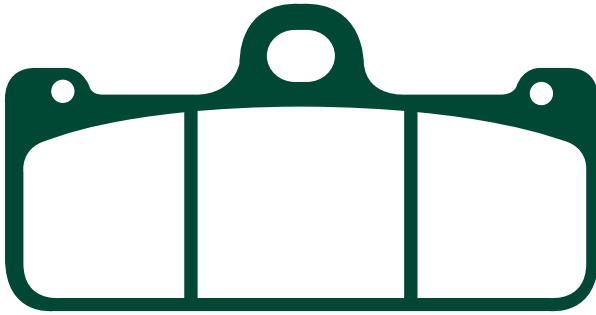

### FA218 - BREMBO

A3 B8 60/61/30/31 Racing radial caliper 2 piece, 4 piston single pin fixing  
X 10 48 13 & 14 GP 2 piece 4 piston caliper (single pin pad fixing)

### APRILIA

SXV 450 07 F  
SXV 549 07 F

### TM

MX 660 06 F

### GFA218/2 - BREMBO

97 37 60/61 Radial monoblock racing 4 piston single pin pad fixing  
X 10 17 40/41 Monobloc 4 piston caliper (single pad pin fixing)

Equivalents OE # - FA218    Equivalents OE # - FA218/2

07 9032 10

07 684831

### Competitor X Ref - FA218

| Dunlop | Ferodo  | SBS | Vesrah  |
|--------|---------|-----|---------|
| DP626  | FDB2007 | 695 | VD969/2 |

| MATERIAL AVAILABILITY AND PART NO. |         |   |     |          |
|------------------------------------|---------|---|-----|----------|
| STD                                | OPTIONS |   |     |          |
| FA                                 | HH      | R | MXS | GFA      |
| FA218                              | FA218HH | - | -   | GFA218HH |

### Competitor X Ref - FA218/2

| Dunlop | Ferodo | SBS | Vesrah |
|--------|--------|-----|--------|
| -      | -      | 711 | VD969  |

| MATERIAL AVAILABILITY AND PART NO. |         |   |     |            |
|------------------------------------|---------|---|-----|------------|
| STD                                | OPTIONS |   |     |            |
| FA                                 | HH      | R | MXS | GFA        |
| -                                  | -       | - | -   | GFA218/2HH |

# FA220 69 x 50.4 x 8.7 mm

### YAMAHA

FZR 250 R 92 F  
R1-Z 350 92 F

### PIN HOLE

Right to left 5.8mm  
Top to bottom 5.0mm

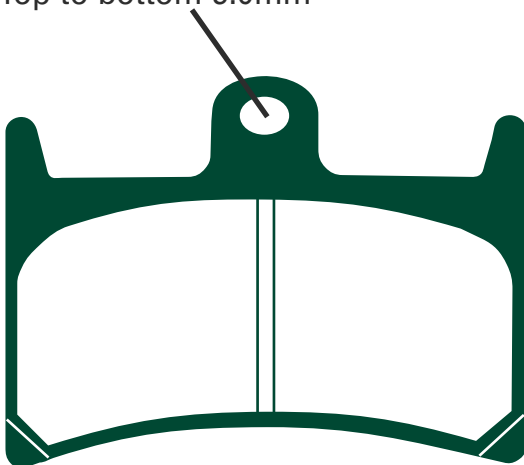

### Equivalents OE #

3LN W0045 00

### Competitor X Ref

| Dunlop | Ferodo | SBS | Vesrah |
|--------|--------|-----|--------|
| -      | -      | 639 | VD-249 |

| MATERIAL AVAILABILITY AND PART NO. |         |   |     |     |
|------------------------------------|---------|---|-----|-----|
| STD                                | OPTIONS |   |     |     |
| FA                                 | HH      | R | MXS | GFA |
| FA220                              | -       | - | -   | -   |

# FA222 52.60 x 56.30 x 9mm

**SUZUKI**

RF 900 RR/RS/RS2

94-95 R

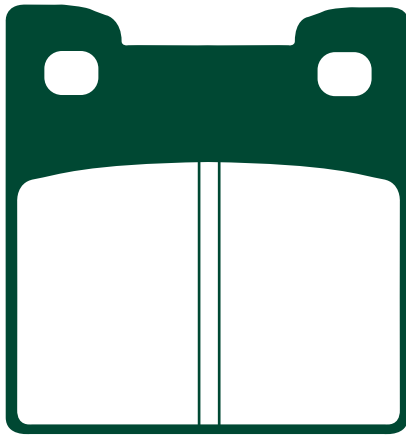

**Equivalents OE #**

|             |
|-------------|
| 69100 31830 |
| 69130 31E00 |

**Competitor X Ref**

| Dunlop | Ferodo  | SBS | Vesrah |
|--------|---------|-----|--------|
| DP217  | FDB2058 | 701 | VD-350 |

**MATERIAL AVAILABILITY AND PART NO.**

| STD   | OPTIONS |   |     |     |
|-------|---------|---|-----|-----|
| FA    | HH      | R | MXS | GFA |
| FA222 | -       | - | -   | -   |

DISC PADS  
BUYERS GUIDE

# FA226 102 x 38 x 9.0mm

# GFA226HH 102 x 38 x 9.0mm Race Use Only

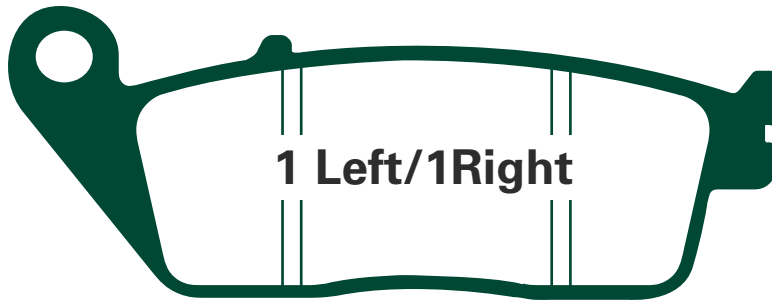

**HONDA**

|  |       |   |
|--|-------|---|
| RS 125   | 90-94 | F |
| RS 250   | 90-94 | F |
| CBR 600 FS/FT/FV/FW                                      | 95-98 | F |
| CB 600 FW/FX/FY/F2-Y/F1/F21/F2/F22/F3/F4/F5/F6/F7 Hornet | 98-07 | F |
| CBF 600 N4/NA4/S4/SA4/N5/NA5/S5/SA5                      | 04-05 | F |
| CBF 600 NA4/NA5/NA6 (ABS Model)                          | 04-06 | F |
| CBF 600 S4/S5 (Non ABS)                                  | 04-05 | F |
| CBF 600 SA4/SA5/SA6 (ABS Model)                          | 04-06 | F |
| CBF 1000 F6/F7   | 06-07 | F |

**Equivalents OE #**

|               |
|---------------|
| 06455 MV4 405 |
| 06455 MR4 405 |
| 06455 MAL G01 |

**Competitor X Ref**

| Dunlop | Ferodo | SBS | Vesrah  |
|--------|--------|-----|---------|
| DP117  | FDB570 | 627 | VD156/2 |

**MATERIAL AVAILABILITY AND PART NO.**

| STD   | OPTIONS |   |     |          |
|-------|---------|---|-----|----------|
| FA    | HH      | R | MXS | GFA      |
| FA226 | FA226HH | - | -   | GFA226HH |

# FA228 A. 96.7 x 42 x 9mm B. 77.3 x 42 x 9mm

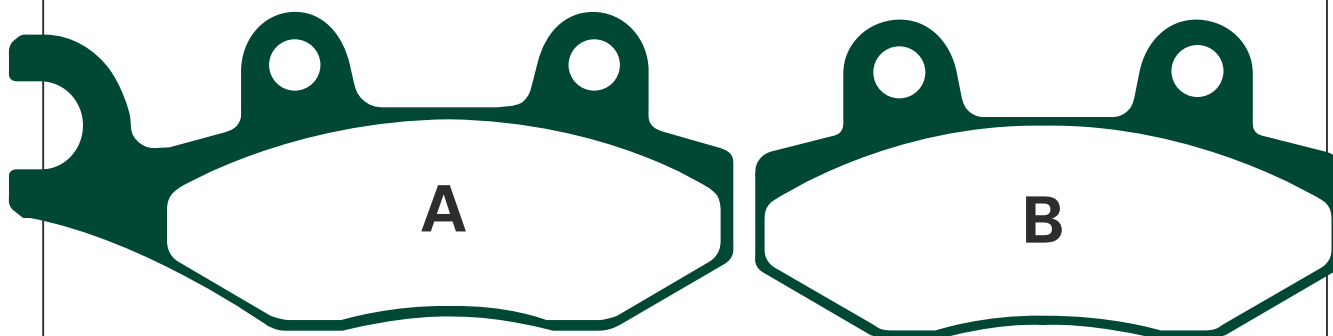

**HARTFORD**

|                       |       |   |
|-----------------------|-------|---|
| VR-125 Z Velo Sport   | 00-03 | F |
| VR-125 X/H Velo-Cross | 00-03 | F |
| CR 125/150 H/X/Z      | 04    | F |

**HONDA**

|                    |       |   |
|--------------------|-------|---|
| CA125 S/T 'Rebel'  | 95-97 | F |
| CMX 250 CT 'Rebel' | 96-97 | F |

**KEEWAY**

|                 |    |     |
|-----------------|----|-----|
| Outlook 125/150 | 07 | F&R |
| Superlight 125  | 07 | F   |

**KYMCO**

|                              |       |         |
|------------------------------|-------|---------|
| Agility 50                   | 05-07 | F       |
| Filly 50 LX (S210)           | 00-06 | F       |
| Vitality 50 (2T & 4T)        | 04-07 | F       |
| Yup 50                       | 01-07 | F       |
| Cobra 100 Racer              | 99-03 | F       |
| Agility 125                  | 06-07 | F       |
| Stryker 125                  | 01-06 | F       |
| Movie 125                    | 99-00 | F       |
| Vivio 125/150                | 00-03 | F       |
| Stryker 150 (Off road)       | 00-06 | F       |
| People 250 S                 | 06    | F(left) |
| Vitality Cross (10" wheels)  | 07    | F       |
| Vitality Sports (12" wheels) | 07    | F       |

**MZ/MUZ**

|        |       |   |
|--------|-------|---|
| SX 125 | 02-07 | F |
| SM 125 | 02-07 | F |

**PEUGEOT**

|                               |       |     |
|-------------------------------|-------|-----|
| Geopolis 250 (Nissin caliper) | 06-07 | F&R |
| Satelis 250 (Nissin calipers) | 06-07 | F&R |
| Geopolis 400                  | 07    | F&R |

**ROYAL ENFIELD**

|                   |       |   |
|-------------------|-------|---|
| Bullet Electra X  | 05-06 | F |
| Electra T         | 05-06 | F |
| Electra Sportsman | 05-06 | F |

**SUZUKI**

|                   |    |         |
|-------------------|----|---------|
| UH 125 K7 Burgman | 07 | R       |
| UH 200 K7 Burgman | 07 | R       |
| AN 400 K7 Burgman | 07 | F(left) |

**SYM**

|        |    |   |
|--------|----|---|
| RS 150 | 06 | R |
|--------|----|---|

**VIALLI**

|              |    |   |
|--------------|----|---|
| DXB 50       | 06 | F |
| Fireforce 50 | 06 | F |

**NOTE: Do not refit any shims from original pads**

**Equivalents OE #**

|                   |                |
|-------------------|----------------|
| 06455 KEB 900     | 902 3002000    |
| 45105 KCE 3050 M2 | 59100 05830    |
| 45105 KKD 6305    | 45110 K2GP 000 |
| 45150 KEC8 3050   |                |

**Competitor X Ref**

| Dunlop | Ferodo | SBS | Vesrah  |
|--------|--------|-----|---------|
| DP211  | FDB497 | 713 | VD340/2 |

**MATERIAL AVAILABILITY AND PART NO.**

| STD   | OPTIONS |   |     |     |
|-------|---------|---|-----|-----|
| FA    | HH      | R | MXS | GFA |
| FA228 | FA228HH | - | -   | -   |

# FA229 A. 133.50 x 36.80 x 8.40mm B. 109.60 x 51.75 x 8.50mm

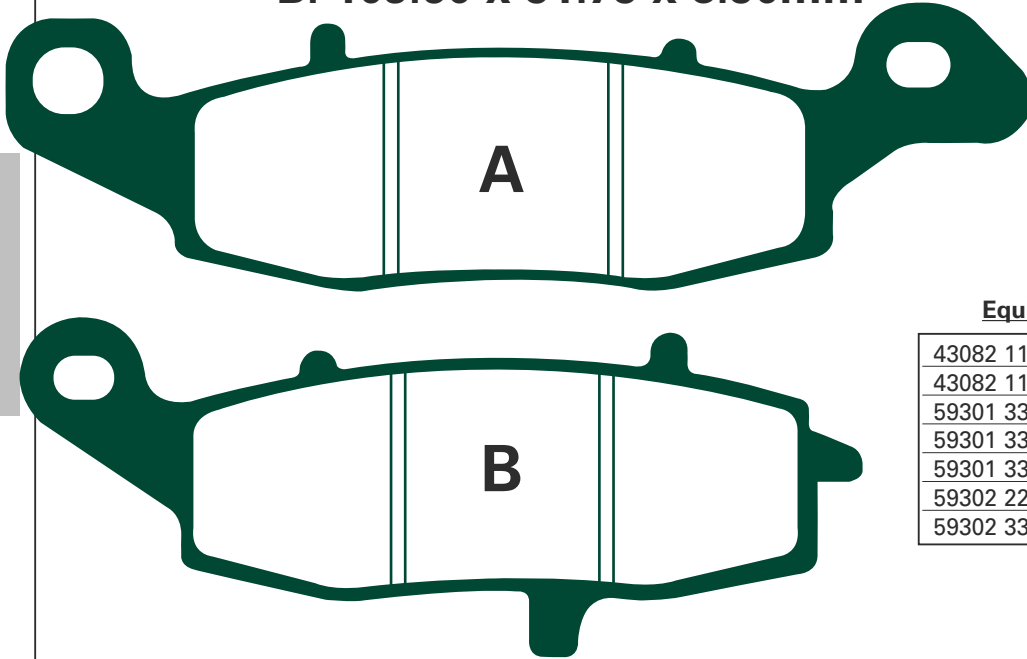

### Equivalents OE #

|             |             |
|-------------|-------------|
| 43082 1177  | 43082 1223  |
| 43082 1187  | 43082 1234  |
| 59301 33820 | 43082 1244  |
| 59301 33830 | 43082 1282  |
| 59301 33840 | 43082 S019  |
| 59302 22850 | 59300 33830 |
| 59302 33810 |             |

DISC PADS  
BUYERS GUIDE

#### KAWASAKI

|                                  |       |         |
|----------------------------------|-------|---------|
| ZR-X 400 E3 (ZR 400 E3)          | 96    | F(left) |
| ER-5 ER 500 C1-C5P               | 01-07 | F       |
| ER-6F (EX 650 A6F/B6F/A7F/B7F)   | 06-07 | F(left) |
| ER-6N (ER 650 A6F/B6F/B7F/A7F)   | 06-07 | F(left) |
| KLE 650 A7F Versys               | 07    | F(left) |
| KLE 650 B7F Versys ABS           | 07    | F(left) |
| KLR 650 C1-C10                   | 95-04 | F       |
| ZR 750 D1 "Zephyr"               | 96-   | F(left) |
| ZR-7 (ZR 750 F1/F3/F5)           | 99-04 | F(left) |
| ZR-7S (ZR 750 H1/H2)             | 01-04 | F(left) |
| Z 750 (ZR 750 J1/J2)             | 04-05 | F(left) |
| Z 750 S (ZR 750 K1/K6F)          | 05-07 | F(left) |
| VN 800 C1/C2/E1/E2/E3 'Drifter'  | 99-04 | F       |
| VN 800 B1-B10/B6F "Classic"      | 96-06 | F       |
| VN 900 A6F Classic               | 06    | F       |
| VN 900 B7F Classic (Spoke wheel) | 07    | F       |
| VN 900 C7F Custom (Cast wheel)   | 07    | F       |
| KLV 1000 (LV 1000 A1H/A2H)       | 04-05 | F(left) |
| GPZ 1100 E1/E2/F1                | 95-98 | F(left) |
| ZR 1100 B1 "Zephyr"              | 96-97 | F(left) |
| ZR 1100 B5 (Zephyr 1100 RS)      | 02    | F(left) |
| VN 1500 D1/D2/E1/E2 "Classic"    | 96-99 | F       |
| VN 1500 G1/G2 Classic Tourer     | 98-00 | F(left) |
| VN 1500 J1/J2/R1/R2/R3 Drifter   | 99-04 | F       |
| VN 1500 L1/L2/L3/L4 "Nomad Fi"   | 00-03 | F(left) |
| VN 1500 N1/N2/N3 Classic Fi      | 00-04 | F       |
| VN 1600 A1/A2/A3/A6F             | 03-07 | F(left) |
| VN 1600 D1H/D6F Classic Tourer   | 05-07 | F(left) |

#### SUZUKI

|   |       |         |
|---|-------|---------|
| GSF 250 VS/S Bandit                                     | 97    | F       |
| TU 250 GY/GBK1 Grass Tracker/<br>Big Boy NJ47A-117/123) | 00-01 | F       |
| GSX 600 FW/FX/FY/FK1/FK2/FK3<br>/FK4/FK5/FK6            | 98-06 | F(left) |
| GSF 600 Y/SY/K1/SK1/K2/SK2/K3/SK3<br>K4/SK4 Bandit      | 00-04 | F(left) |
| DL 650 K4/K5/K6 V-Strom                                 | 04-06 | F(left) |
| DL 650 AK7 VStrom ABS                                   | 07    | F(left) |
| DL 650 K7   | 07    | F(left) |
| GSF 650 K5/SK5 Bandit                                   | 05    | F(left) |
| GSF 650 K6/SAK6 (Bandit ABS)                            | 06    | F(left) |
| SV 650 X/Y/K1/K2/K3/K4/K5/K6/K7                         | 99-07 | F(left) |
| SV 650 SX/SY/SK1/SK2/SK3/SK4/SK5/SK6/SK7                | 99-07 | F(left) |
| SV 650 AK7/SAK7 ABS model                               | 07    | F(left) |
| GSX 750 W/FX/FY/FK1/FK2/FK3/FK4/FK5/FK6                 | 98-06 | F(left) |
| GSX 750 W/X/Y   | 98-03 | F(left) |
| DL 1000 K2/K3/K4/K5/K6/K7 V-Strom                       | 02-07 | F(left) |
| VL 1500 K2/K3   | 02-03 | F(left) |
| VL 1500 K5/K6/K7 (C1500 Intruder)                       | 05-07 | F(left) |

#### Competitor X Ref

| Dunlop | Ferodo  | SBS | Vesrah |
|--------|---------|-----|--------|
| DP322  | FDB2048 | 705 | VD-435 |

#### MATERIAL AVAILABILITY AND PART NO.

| STD   | OPTIONS |   |     |          |
|-------|---------|---|-----|----------|
| FA    | HH      | R | MXS | GFA      |
| FA229 | FA229HH | - | -   | GFA229HH |

# FA230 A. 99.00 x 44.10 x 7.56mm B. 75.50 x 37.90 x 8.26

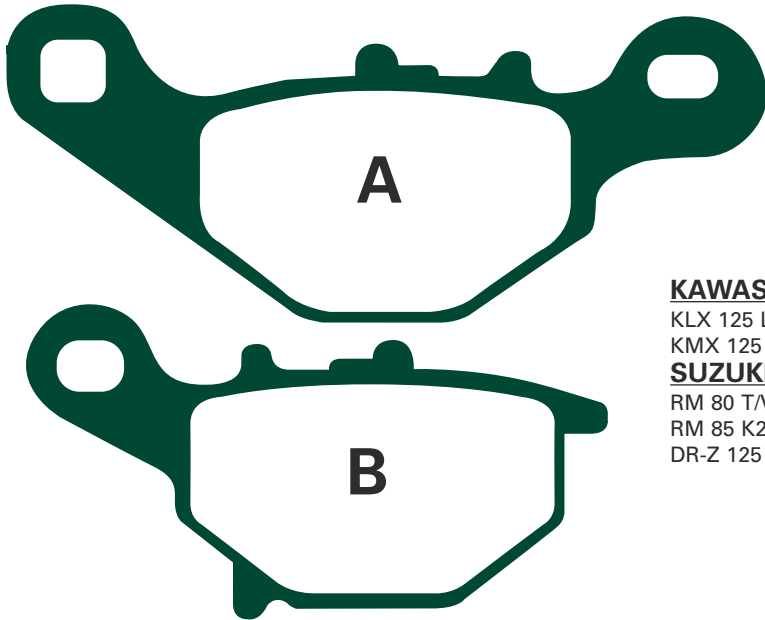

### KAWASAKI

KLX 125 L (B1/B2/B3/B6F) 03-06 F  
 KMX 125 B10/B11/B12 99-03 F

### SUZUKI

RM 80 T/V/W/X/Y/K1 96-01 F  
 RM 85 K2/LK2/K3/LK3/LK4/K4 02-04 F  
 DR-Z 125 LK3/LK4/LK5/LK6/LK7 03-07 F

### Equivalents OE #

|             |            |
|-------------|------------|
| 59300 03880 | 43082 S005 |
| 59300 03891 | 43082 S015 |

### Competitor X Ref

| Dunlop | Ferodo | SBS | Vesrah |
|--------|--------|-----|--------|
| DP218  | -      | 702 | VD-351 |

| MATERIAL AVAILABILITY AND PART NO. |         |        |     |     |
|------------------------------------|---------|--------|-----|-----|
| STD                                | OPTIONS |        |     |     |
| FA                                 | HH      | R      | MXS | GFA |
| FA230TT                            | -       | FA230R | -   | -   |

# FA231 A. 133.50 x 36.80 x 8.40mm B. 109.60 x 51.75 x 8.50mm

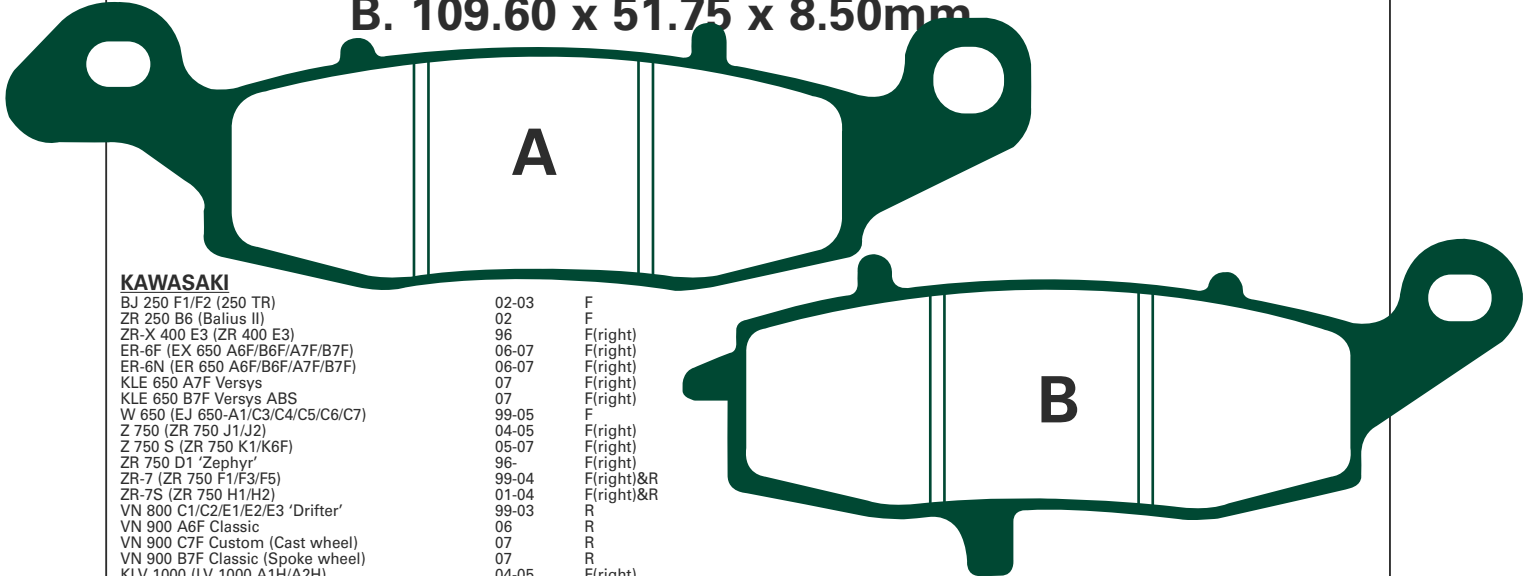

### KAWASAKI

BJ 250 F1/F2 (250 TR) 02-03 F  
 ZR 250 B6 (Balius II) 02 F  
 ZR-X 400 E3 (ZR 400 E3) 96 F(right)  
 ER-6F (EX 650 A6F/B6F/A7F/B7F) 06-07 F(right)  
 ER-6N (ER 650 A6F/B6F/A7F/B7F) 06-07 F(right)  
 KLE 650 A7F Versys 07 F(right)  
 KLE 650 B7F Versys ABS 07 F(right)  
 W 650 (EJ 650-A1/C3/C4/C5/C6/C7) 99-05 F  
 Z 750 (ZR 750 J1/J2) 04-05 F(right)  
 Z 750 S (ZR 750 K1/K6F) 05-07 F(right)  
 ZR 750 D1 'Zephyr' 96- F(right)  
 ZR-7 (ZR 750 F1/F3/F5) 99-04 F(right)&R  
 ZR-7S (ZR 750 H1/H2) 01-04 F(right)&R  
 VN 800 C1/C2/E1/E2/E3 'Drifter' 99-03 R  
 VN 900 A6F Classic 06 R  
 VN 900 C7F Custom (Cast wheel) 07 R  
 VN 900 B7F Classic (Spoke wheel) 07 R  
 KLV 1000 (LV 1000 A1H/A2H) 04-05 F(right)  
 GPz 1100 E1/E2/F1 95-98 F(right)  
 ZR 1100 B1 'Zephyr' 96-97 F(right)  
 ZR 1100 B5 (Zephyr 1100 RS) 02 F(right)  
 VN 1500 G1/G2 Classic Tourer 98-99 F(right)  
 VN 1500 J1/J2/R1/R2/R3 Drifter 99-04 R  
 VN 1500 L1/L2/L3/L4 'Nomad Fi' 00-03 F(right)&R  
 VN 1500 N1/N2/N3 'Classic Fi' 00-04 R  
 VN 1500 P1/P2 Mean Streak 02-04 R  
 VN 1600 A1/A2/A3/A6F 03-07 F(right)&R  
 VN 1600 B1 Mean Streak 04 R  
 VN 1600 B2H/B6F (Mean Streak) 05-07 R  
 VN 1600 D1H/D6H Classic Tourer 05-07 F(right)&R  
 VN 2000 A1/A2/A6F/F7F 04-07 R

### SUZUKI

RV 125 K2/K3/K4/K5/K6/K7 Van-van 02-07 F  
 RV 200 K2/K3 02-03 F  
 GSX 250 FXX2 02 F  
 TU 250 TX1/X1XTY (NJ47A-115) Volty 99-00 F  
 GS 500 ET/EV/EW/EX/EY/K1/K2/K3/FK4/FK5/K5/FK6/K6/K7/FK7 96-07 F  
 GSF 600 Y/SY/K1/SY1/K2/SK2/SK3/K3 /K4/SK4 Bandit 00-04 F(right)  
 GSX 600 FW/FX/FY/FK1/FK2/FK3/FK4/FK5/FK6 98-06 F(right)  
 DL 650 K4/K5/K6 V-Strom 04-06 F(right)  
 DL 650 AK7 VStrom ABS 07 F(right)  
 DL 650 K7 07 F(right)  
 GSF 650 K5/SK5 Bandit 05 F(right)  
 GSF 650 K6/SAK6 (Bandit ABS) 06 F(right)  
 SV 650 X/Y/K1/K2/K3/K4/K5/SK6/K6/K7 99-07 F(right)  
 SV 650 SX/SY/SK1/SK2/SK3/SK4/SK5/SK6/K6/AK7 99-07 F(right)  
 SV 650 AK7/SAK7 ABS model 07 F(right)  
 XF 650 V/W/X/Y Freewind 97-02 F  
 GSX 750 FW/FX/FY/FK1/FK2/FK3/FK4/FK5/FK6 98-06 F(right)  
 GSX 750 W/X/Y 98-03 F(right)  
 VL 800 K1/K2/K3/K4 'Intruder Volusia' 01-04 F  
 VL 800 K5/K6/K7 (C 800 Intruder) 05-07 F

VZ 800 V/W/X/Y/K1/K2 Marauder 97-03 F  
 VZ 800 K5-K7 Intruder M800 05-07 F  
 DL 1000 K2/K3/K4/K5/K6/K7 V-strom 02-07 F(right)  
 VL 1500 K2/K3 02-03 F(right)  
 VL 1500 K5/K6/K7 (C1500 Intruder) 05-07 F(right)  
 VZ 1600 K4 Marauder 04 R  
 VZ 1600 K5 (M1600 Intruder) 05 R  
 VZ 1800 K6/K7 (M 1800 R Intruder) 06-07 R

### Competitor X Ref

| Dunlop | Ferodo  | SBS | Vesrah |
|--------|---------|-----|--------|
| DP323  | FDB2049 | 704 | VD-352 |

### Equivalents OE #

|            |            |             |             |
|------------|------------|-------------|-------------|
| 43082 0015 | 43082 1243 | 43082 1283  | 59101 33830 |
| 43082 1178 | 43082 1246 | 43082 S018  | 59101 33850 |
| 43082 1188 | 43082 1248 | 59100 33830 | 59102 33810 |
| 43082 1203 | 43082 1260 | 59100 33850 | 59102 33840 |
| 43082 1226 | 43082 1264 | 59100 33870 | K4308-21203 |
| 43082 1232 | 43082 1265 | 59101 33810 | K4308-21264 |
| 43082 1235 | 43082 1280 | 59101 33820 |             |

| MATERIAL AVAILABILITY AND PART NO. |         |   |     |          |
|------------------------------------|---------|---|-----|----------|
| STD                                | OPTIONS |   |     |          |
| FA                                 | HH      | R | MXS | GFA      |
| FA231                              | FA231HH | - | -   | GFA231HH |

# FA232 72.5 x 43.7 x 7mm

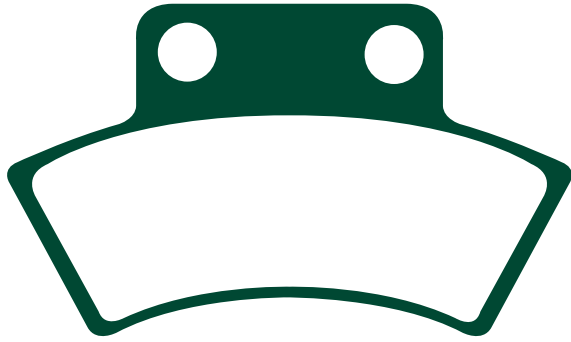

**POLARIS**

Rear pad most models 89-00  
See main application list for full details.

This pad has increased friction area.  
Can be fitted in place of FA178 to improve wear life on Polaris ATV's

**JORDAN**

HIPO/MARS/BOB 50/90/100 03-04 R

**Equivalents OE #**

|         |
|---------|
| 2200899 |
| 2200456 |

**Competitor X Ref**

| Dunlop | Ferodo  | SBS | Vesrah |
|--------|---------|-----|--------|
| DP909  | FDB2054 | 717 | VD950  |

**MATERIAL AVAILABILITY AND PART NO.**

| STD     | OPTIONS |        |     |     |
|---------|---------|--------|-----|-----|
| FA      | HH      | R      | MXS | GFA |
| FA232TT | -       | FA232R | -   | -   |

# FA233 75.1 x 37.2 x 9.5mm



**KYMCO**

|                         |       |   |
|-------------------------|-------|---|
| Cobra 50 Cross          | 00-06 | F |
| Cobra Racer (SF10AG)    | 00-06 | F |
| CX 50 Super (PR50AC)    | 94-97 | F |
| K12 Sport 50 (SE10CA)   | 95-00 | F |
| KB 50 (SE10CA)          | 95-00 | F |
| Looping 50              | 98    | F |
| Top Boy 50 (SF10GG)     | 97-06 | F |
| ZX 50 Super Fever/Scout | 99-06 | F |
| KB 50 Scout             | 97    | F |
| Filly 50 LX             | 00-02 | F |
| Sniper 50 (PR 50 B)     | 93    | F |
| Sniper 50 DD (PR50BB)   | 94-96 | F |
| KB 100 Manboy           | 97-00 | F |
| Top Boy 100             | 97    | F |
| 49 ef 10"               | 07    | F |

**Equivalents OE #**

|                   |
|-------------------|
| 45105 KCX E050    |
| 45105 KCX 3050 MZ |
| 45105 KCU 3050    |

**Competitor X Ref**

| Dunlop | Ferodo | SBS | Vesrah |
|--------|--------|-----|--------|
| N/A    | N/A    | N/A | N/A    |

**MATERIAL AVAILABILITY AND PART NO.**

| STD   | OPTIONS |   |     |     |
|-------|---------|---|-----|-----|
| FA    | HH      | R | MXS | GFA |
| FA233 | -       | - | -   | -   |

# FA234 58.9 x 44.6 x 9.4mm

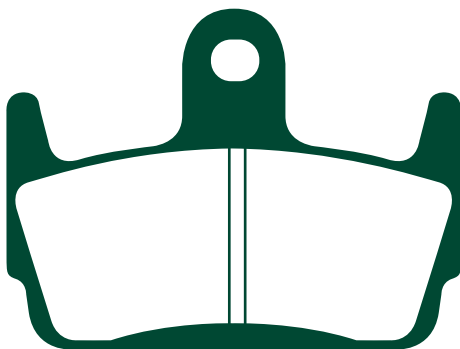

**HONDA**

|   |       |   |
|---|-------|---|
| SZX 50 X8R-SW/SX/SY/S1 "Supersport Scooter" | 98-04 | R |
| SZX 50 X8R-XW/XX/XY/X1 "Cross Sport"        | 98-04 | R |

**KYMCO**

|                       |       |   |
|-----------------------|-------|---|
| Sniper 50 DD (PR50BB) | 94-96 | R |
| Heroism 150           | 95-97 | R |

**SYM**

|                         |       |   |
|-------------------------|-------|---|
| Jet Sport X 50 (R/S/SR) | 06-07 | R |
|-------------------------|-------|---|

**Equivalents OE #**

|                   |
|-------------------|
| 06435 GCM 900     |
| 06435 GCM 902     |
| 43105 KBF 3050 MZ |
| 43105 KBF 9000    |
| 45105 TFA 000 A   |

**Competitor X Ref**

| Dunlop | Ferodo | SBS | Vesrah |
|--------|--------|-----|--------|
| DP014  | N/A    | 710 | N/A    |

**MATERIAL AVAILABILITY AND PART NO.**

| STD   | OPTIONS |   |     |     |
|-------|---------|---|-----|-----|
| FA    | HH      | R | MXS | GFA |
| FA234 | -       | - | -   | -   |

# FA235 59.5 x 44.5 x 9mm

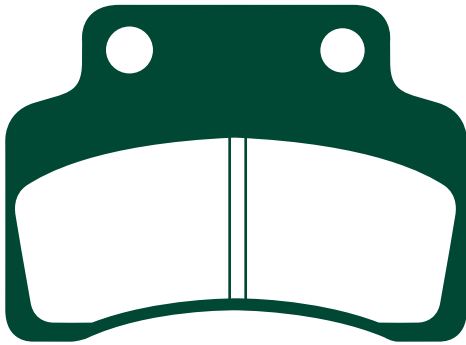

**Equivalents OE #**

|                   |
|-------------------|
| 45150 KBK 9000 MZ |
| 45110 J4FT 000    |

**Competitor X Ref**

| Dunlop | Ferodo  | SBS | Vesrah |
|--------|---------|-----|--------|
| -      | FDB2191 | 723 | -      |

**BENELLI**

49X-Scooter 07 F

**CPI**

Argon 50 07 F  
 Argon Gp50 07 F  
 Freaky 50 07 F  
 Oliver 50 (All models) 03-06 F  
 Hussar 50 03-05 F  
 Popcorn 50 03-05 F  
 Argon Gp125 07 F  
 Oliver City 125 06 F

**CSR**

ONA 125 (4T) 04-06 F&R  
 Scoo 125 (4T) 04-06 F&R

**GARELLI**

VIP 50 07 F

**GENERIC**

XOR 50 05-07 F  
 Ideo 50 05-07 F  
 Soho 125 06-07 F  
 XOR 125 05-07 F

**KEEWAY**

Flash 50 07 F  
 F-Act 50 07 F  
 Matrix 50 07 F  
 Matrix 125 07 F

**KM (KEENMOTORBIKES)**

Badboy 50 CX 05 F  
 Badboy 100 CX 05 F

**KYMCO**

DJW 50 World (PR50AD) 95-97 R  
 Heroism 125 (SE25BA) 95-97 F  
 Heroism 50 (SE10BA) 95-97 F  
 Heroism 150 (SE30AD) 95-97 F

**MATERIAL AVAILABILITY AND PART NO.**

| STD   | OPTIONS |   |     |     |
|-------|---------|---|-----|-----|
| FA    | HH      | R | MXS | GFA |
| FA235 | -       | - | -   | -   |

# FA236 70 x 55.5 x 8.3mm

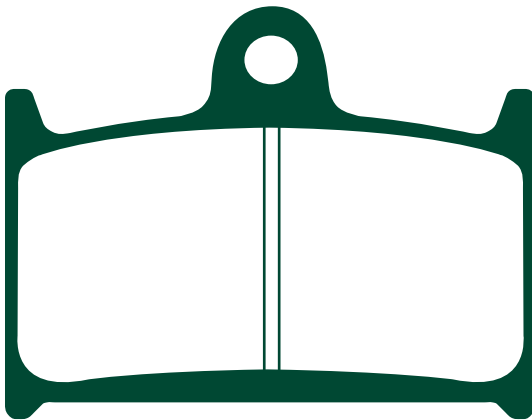

**TRIUMPH**

T595 Daytona 97 F  
 Daytona 600 03-04 F  
 Daytona 650 05 F  
 Speedfour 600 02-05 F  
 TT 600 00-03 F  
 Daytona 750 92 F  
 Daytona 900 93-96 F  
 Trophy 900 94-01 F  
 Daytona 955i 98-06 F  
 Speed Triple 94-01 F  
 Speed Triple 955cc 02-04 F  
 Daytona 1000 92 F  
 Daytona 1200 93-98 F  
 Trophy 1200 94-01 F  
 Rocket 111 (2300cc) 04-07 F  
 Rocket 111 Classic 07 F  
 Sprint 94-98 F  
 Sprint RS/ST 99-04 F  
 Sprint ST (1050cc) 05-06 F

**Equivalents OE #**

|               |          |
|---------------|----------|
| 2020073 T0301 | T2020245 |
| T2020193      | T2020246 |

**Competitor X Ref**

| Dunlop | Ferodo | SBS | Vesrah |
|--------|--------|-----|--------|
| DP213  | FDB557 | 624 | VD343  |

**MATERIAL AVAILABILITY AND PART NO.**

| STD   | OPTIONS |   |     |     |
|-------|---------|---|-----|-----|
| FA    | HH      | R | MXS | GFA |
| FA236 | FA236HH | - | -   | -   |

# FA237 USE FA229

**FA239 69.65 x 51.85 x 8.5mm**

**GFA239HH 69.65 x 51.85 x 8.5mm Race use only**

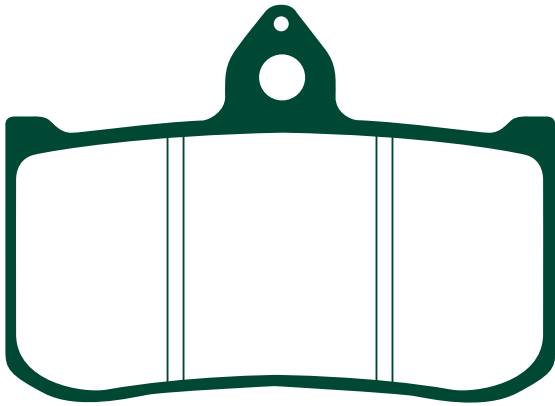

**HONDA (RACE BIKES)**

|        |       |   |
|--------|-------|---|
| RS 125 | 95-06 | F |
| RS 250 | 93-06 | F |

**Equivalents OE #**

45105 NX4 770

**Competitor X Ref**

|               |               |            |               |
|---------------|---------------|------------|---------------|
| <b>Dunlop</b> | <b>Ferodo</b> | <b>SBS</b> | <b>Vesrah</b> |
| RDP123        | FDB858        | -          | -             |

**MATERIAL AVAILABILITY AND PART NO.**

| STD   | OPTIONS |   |     |         |
|-------|---------|---|-----|---------|
| FA    | HH      | R | MXS | GFA     |
| FA239 | -       | - | -   | GA239HH |

# FA243 98.9 x 49.5 x 8.5mm

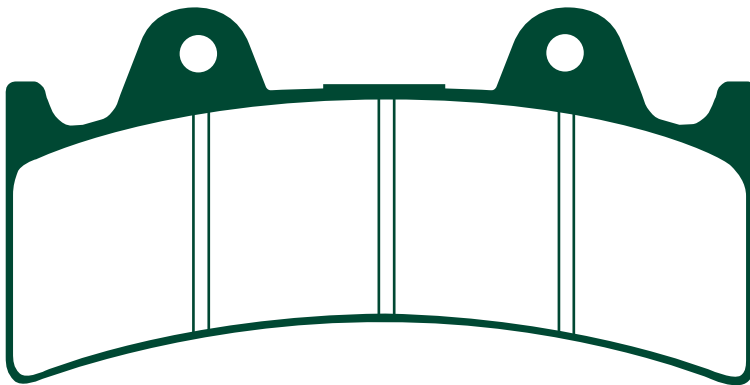

**ALCON**

6 Piston Race Caliper with 4.0mm pin set

Similar to FA190 with difference in pad pin diameter and thickness

**JAYBRAKE**

6 piston caliper

**Equivalents OE #**

N/A

**Competitor X Ref**

|               |               |            |               |
|---------------|---------------|------------|---------------|
| <b>Dunlop</b> | <b>Ferodo</b> | <b>SBS</b> | <b>Vesrah</b> |
| DP627         | FDB2031       | -          | -             |

**MATERIAL AVAILABILITY AND PART NO.**

| STD   | OPTIONS |   |     |          |
|-------|---------|---|-----|----------|
| FA    | HH      | R | MXS | GFA      |
| FA243 | FA243HH | - | -   | GFA243HH |



# FA244 75 x 55 x 8.70mm

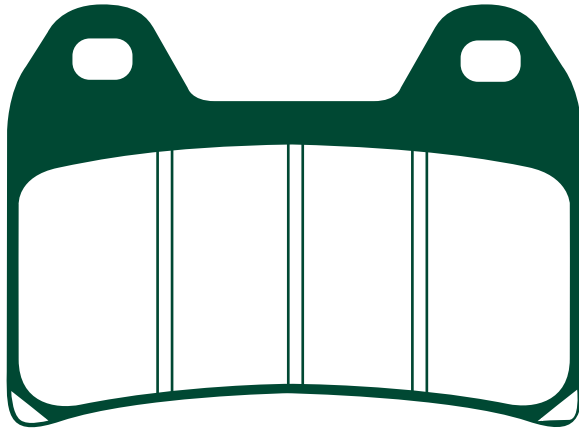

## APRILIA

|                         |       |   |
|-------------------------|-------|---|
| RS 250                  | 98-02 | F |
| Pegaso Strada 650       | 05-06 | F |
| Pegaso 650 Factory      | 06    | F |
| Pegaso 650              | 07    | F |
| ETV 1000 Caponord       | 01-02 | F |
| RSV 1000 "All models"   | 98-99 | F |
| SL 1000 Falco           | 00-04 | F |
| RSV 1000 Mille/Miller   | 00    | F |
| RST Futura 1000         | 01-04 | F |
| 1000 Tuono (All models) | 02-06 | F |

## BIMOTA

|                                   |        |   |
|-----------------------------------|--------|---|
| Later models                      | 98/99- | F |
| SB8K Gobert (996cc Suzuki engine) | 06     | F |

## BENELLI

|                            |       |   |
|----------------------------|-------|---|
| TNT 899 Tornado Naked Tre  | 07    | F |
| Trek 899                   | 07    | F |
| Tornado 900                | 02    | F |
| TNT 1130 Cafe Racer        | 05    | F |
| TNT 1130 Titanium          | 05    | F |
| TNT 1130 Tornado Naked Tre | 06-07 | F |
| TRE-K 1130                 | 06-07 | F |
| Trek 1130 Amazonas         | 07    | F |

## BMW

|             |       |   |
|-------------|-------|---|
| F 800 S/ST  | 06-07 | F |
| G 650 Xmoto | 07    | F |

## BREMBO

20 6800 10/20 4 piston (two pin pad fixing)

## CAGIVA

|                      |       |   |
|----------------------|-------|---|
| Raptor 650           | 00-07 | F |
| 1000 Raptor/V-Raptor | 00-05 | F |

## DUCATI

|                      |       |   |
|----------------------|-------|---|
| 400 Monster/Dark     | 00-04 | F |
| 600 Monster          | 00-01 | F |
| 620/IE/SIE Monster   | 02-04 | F |
| 620 Sport            | 03    | F |
| Monster 620 Dark     | 03-04 | F |
| Monster 620 Catwoman | 05    | F |
| Multistrada 620 Dark | 05-06 | F |
| 748 Racing/SPS       | 98    | F |
| 748 Biposto          | 99    | F |
| 748 Racing           | 99    | F |
| 748 SPS              | 99    | F |
| 748 Biposto          | 00-02 | F |
| 748 R/RS/S           | 00    | F |
| 748 S                | 01-02 | F |
| 748 Testa Bassa      | 01    | F |
| 748 E                |       | F |
| 750 Supersport       | 99    | F |
| 750 Supersport IE    | 00-02 | F |

### Equivalent OE #

|               |                |              |
|---------------|----------------|--------------|
| 06455 MY9 871 | 8113754        | R30000126000 |
| 4HM W0045 00  | 8113720        | 2202492      |
| 4HM W0045 50  | 8133614        | 1D2 W0045 00 |
| 59100 03860   | 8000 88772     | 211082018    |
| 613 4 0201 A  | 8000 95542     | 4KG W045 10  |
| 613 4 0211 B  | 000016546300   | 107 6708 21  |
| 613 4 0411 A  | 587 13 030 000 |              |

### MATERIAL AVAILABILITY AND PART NO.

| STD   | OPTIONS |   |     |          |
|-------|---------|---|-----|----------|
| FA    | HH      | R | MXS | GFA      |
| FA244 | FA244HH | - | -   | GFA244HH |

|                                  |       |   |
|----------------------------------|-------|---|
| 750 Sport                        | 01-02 | F |
| 750 Monster                      | 0-01  | F |
| Monster 800/IE/SIE               | 03-04 | F |
| 800 Sport                        | 03    | F |
| 800 Supersport                   | 03-04 | F |
| 900 Supersport                   | 98-99 | F |
| 900 Supersport IE                | 00-01 | F |
| 900 Sport                        | 02    | F |
| 900 IE Monster                   | 00-01 | F |
| 900 MH Evoluzione                | 00-01 | F |
| 916 SPS (996cc)                  | 98    | F |
| Sport Touring ST4-916cc          | 99-03 | F |
| Monster S4                       | 01-03 | F |
| Sport Touring ST2-944cc          | 97-02 | F |
| 996                              | 98    | F |
| 996 SPS/SPS II                   | 99-00 | F |
| 996                              | 00    | F |
| 996 S                            | 01    | F |
| Monster S4R (996cc)              | 03-06 | F |
| Sport Touring ST4S 996cc         | 01-05 | F |
| Sport Touring 996cc ST4S-ABS     | 03-05 | F |
| S2R (992cc)                      | 06    | F |
| STS 3 (992)                      | 04-05 | F |
| ST3S (ABS Model)                 | 06-07 | F |
| 998                              | 02-03 | F |
| Multi Strada 1000 DS/1000 SDS    | 03-06 | F |
| 1000 Supersport DS               | 03-06 | F |
| Monster 1000 IE/SIE              | 03-05 | F |
| Multistrada 1100/1100 S (1078cc) | 07    | F |

## HONDA

|                           |    |   |
|---------------------------|----|---|
| CB 400 SF (F3V) Superfour | 97 | F |
|---------------------------|----|---|

## HUSQVARNA

|                              |       |   |
|------------------------------|-------|---|
| SM 610 (6 bolt front disc)   | 98-00 | F |
| SM 610/S (4 bolt front disc) | 02-06 | F |
| SM 610 R                     | 00    | F |
| LT 610 (6 bolt front disc)   | 00    | F |

## KTM

|                          |       |   |
|--------------------------|-------|---|
| SMC 625                  | 05    | F |
| Duke II 640 (All models) | 01-00 | F |
| SMC 640 LC4              | 05    | F |
| SMC 660                  | 05-06 | F |
| 690 Supermoto            | 07    | F |

## MAGNI

|                |    |   |
|----------------|----|---|
| Sport 1200 'S' | 01 | F |
|----------------|----|---|

## MOTO GUZZI

|                                       |       |   |
|---------------------------------------|-------|---|
| Breva V 750 IE                        | 03-07 | F |
| Nevada Classic 750 ie                 | 05-07 | F |
| Nevada 750 Touring                    | 07    | F |
| Breva 850                             | 07    | F |
| Griso 850                             | 07    | F |
| Norge 850                             | 07    | F |
| 940 Custom                            | 07    | F |
| Breva V1100                           | 05    | F |
| Breva 1100 (ABS)                      | 07    | F |
| Griso 1100                            | 05    | F |
| VII (All models)                      | 99-06 | F |
| California EV/Special/Jackal          | 01    | F |
| California Classic 1100               | 07    | F |
| V 1100 Breva                          | 04    | F |
| Breva 1100                            | 05-06 | F |
| Griso 1100                            | 05-07 | F |
| Griso 1100 (8 valve) (Radial caliper) | 07    | F |
| Norge 1200                            | 06-07 | F |
| 1200 Sport                            | 07    | F |

## MOTO MORINI

|                     |       |   |
|---------------------|-------|---|
| Corsaro 1200        | 05-06 | F |
| Corsaro 1200 Veloce | 07    | F |
| MM3 (1187cc)        | 07    | F |
| 9 1/2 (998cc)       | 06    | F |

## SCORPA

|              |    |   |
|--------------|----|---|
| Raidster 660 | 07 | F |
|--------------|----|---|

## SUZUKI

|                                 |       |   |
|---------------------------------|-------|---|
| GSX 400 X Impulse               | 99    | F |
| GSX 400 FSV/FSK1 (GK7B) Inazuma | 00    | F |
| GSX 1200 FSW/FSX 'Inazuma'      | 98-99 | F |

## VICTORY

|                    |       |   |
|--------------------|-------|---|
| Victory All models | 98-07 | F |
|--------------------|-------|---|

## VOXAN

|             |       |   |
|-------------|-------|---|
| Black Magic | 04-05 | F |
| VB1-Evo     | 03-04 | F |
| Cafe Racer  | 06    | F |
| Roadster    | 06    | F |

## YAMAHA

|  |       |   |
|--|-------|---|
| FZ 400   | 96    | F |
| XJR 400 (4HM3/4HM5/4HM6/4HM9/4HMA/4HMB) Brembo calipers) | 95-99 | F |
| XT 660 X Supermoto                                       | 04-07 | F |
| XJR 1300 (5EA1/5EA7 Brembo calipers (320mm front discs)  | 98-99 | F |

### Competitor X Ref

| Dunlop | Ferodo  | SBS     | Vesrah |
|--------|---------|---------|--------|
| DP630  | FDB2042 | 706/727 | -      |

# FA245 94 x 37.3 x 8mm

**APRILIA**  
RST 1000 Futura

01-04 R



1 Left/1Right

Equivalents OE #

8133516

Competitor X Ref

|                        |                           |                   |                        |
|------------------------|---------------------------|-------------------|------------------------|
| <b>Dunlop</b><br>DP628 | <b>Ferodo</b><br>FDB2039R | <b>SBS</b><br>742 | <b>Vesrah</b><br>VD947 |
|------------------------|---------------------------|-------------------|------------------------|

| MATERIAL AVAILABILITY AND PART NO. |         |   |     |     |
|------------------------------------|---------|---|-----|-----|
| STD                                | OPTIONS |   |     |     |
| FA                                 | HH      | R | MXS | GFA |
| FA245                              | FA245HH | - | -   | -   |

DISC PADS  
BUYERS GUIDE

# FA246 USE FA407

# FA249 91.6 x 51.5 x 8.5mm

# FA249/2 91.6 x 51.5 x 12mm

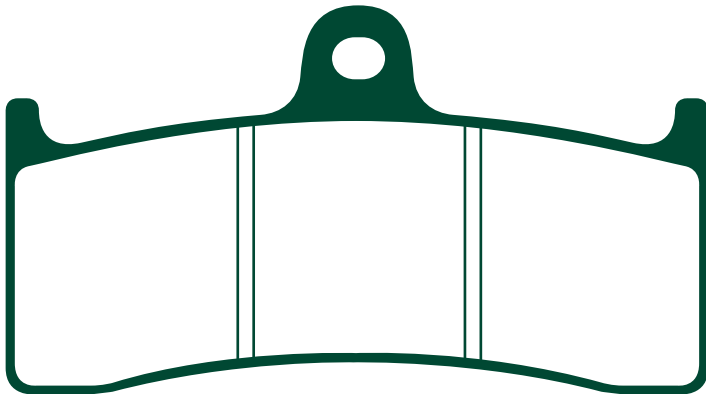

**PERFORMANCE MACHINE**

112X6B  
112X6QC

**PRE TECH**

6 Piston (Radial Mount)

**FA249/2**

Behringer Endurance Caliper

Competitor X Ref - FA249

|                        |                          |                   |                        |
|------------------------|--------------------------|-------------------|------------------------|
| <b>Dunlop</b><br>DP324 | <b>Ferodo</b><br>FDB2036 | <b>SBS</b><br>779 | <b>Vesrah</b><br>VD437 |
|------------------------|--------------------------|-------------------|------------------------|

| MATERIAL AVAILABILITY AND PART NO. |         |   |     |          |
|------------------------------------|---------|---|-----|----------|
| STD                                | OPTIONS |   |     |          |
| FA                                 | HH      | R | MXS | GFA      |
| FA249                              | FA249HH | - | -   | GFA249HH |

| MATERIAL AVAILABILITY AND PART NO. |         |   |     |            |
|------------------------------------|---------|---|-----|------------|
| STD                                | OPTIONS |   |     |            |
| FA                                 | HH      | R | MXS | GFA        |
| FA249/2                            | -       | - | -   | GFA249/2HH |

# FA251 A. 55.5 x 37 x 10mm B. 85 x 43 x 8mm

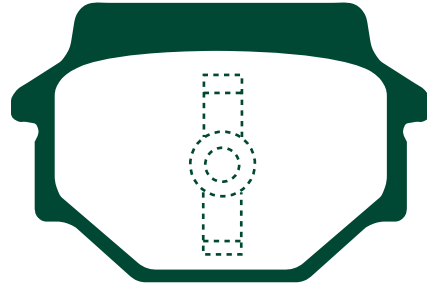
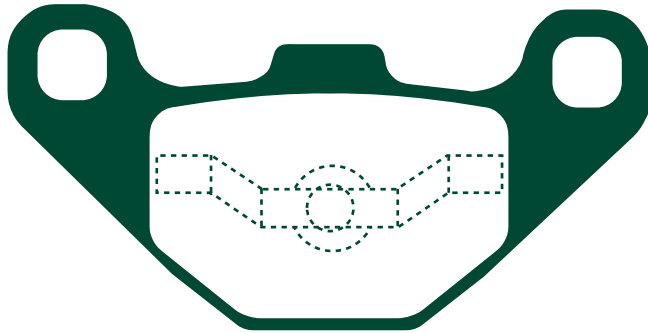

### BUELL

|                  |       |   |
|------------------|-------|---|
| S2 "Thunderbolt" | 94-97 | R |
| S3 "Thunderbolt" | 94-97 | R |
| M2 Cyclone       | 94-97 | R |
| S1 Lightning     | 94-97 | R |

### HUSABERG

|                                  |    |   |
|----------------------------------|----|---|
| Enforcer four 400/501/600 & Quad | 99 | R |
|----------------------------------|----|---|

### HUSQVARNA

|        |       |   |
|--------|-------|---|
| CR 125 | 91    | R |
| WR 125 | 91    | R |
| WR 240 | 90-91 | R |
| CR 250 | 91    | R |
| WR 250 | 90-91 | R |
| WR 260 | 90-91 | R |
| TE 350 | 90-91 | R |
| TE 510 | 90    | R |
| TC 510 | 90    | R |
| TC 610 | 91    | R |
| TE 610 | 91    | R |

### Equivalents OE #

|            |
|------------|
| 42385 94Y  |
| 8000 60195 |

### Competitor X Ref

| Dunlop | Ferodo | SBS | Vesrah |
|--------|--------|-----|--------|
| DP310  | FDB314 | 692 | -      |

### MATERIAL AVAILABILITY AND PART NO.

| STD   | OPTIONS |   |     |     |
|-------|---------|---|-----|-----|
| FA    | HH      | R | MXS | GFA |
| FA251 | -       | - | -   | -   |

# FA252 50.4 x 69 x 8.7mm

## GFA252HH (Race use only)

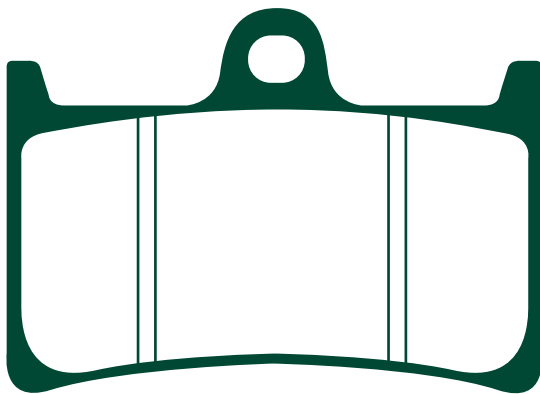

### YAMAHA

|                                       |       |   |
|---------------------------------------|-------|---|
| TZR 125 R                             | 93-   | F |
| TZR 250 R (3XV8/9)                    | 92-94 | F |
| TZR 250 (3MA1)                        | 89    | F |
| TZR 250 (3MA3/A5)                     | 90    | F |
| TZR 250 SP (3MA4)                     | 90    | F |
| TZR 250 R (3XV1/4/6)                  | 91    | F |
| FZR 400 RR (4DX)                      | 92    | F |
| FZR 400 RR (3TJ1/2/6/7)               |       | F |
| FZS 600 Fazer                         | 98-03 | F |
| FZ6 S2 ABS (Naked)                    | 07    | F |
| YZF 600 R "Thundercat"                | 96-03 | F |
| YZF 'R6'                              | 99-04 | F |
| YZF-R7 750 '0W02' (Road version)      | 99-01 | F |
| TDM 900 P/R/S/T/V                     | 02-07 | F |
| TDM 900 AT/AW/AW (ABS)                | 05-07 | F |
| FZS 1000 Fazer                        | 01-05 | F |
| YZF 1000 R "Thunderace"               | 96-02 | F |
| YZF R1                                | 98-03 | F |
| BT 1100 P/R/S/T/V Bulldog             | 02-06 | F |
| FJR 1300 N/P                          | 01-02 | F |
| FJR 1300 R/AR/S/AS/AT/T (ABS)         | 03-05 | F |
| XJR 1300 L 5EA2/5EA3/5EA4             | 99    | F |
| XJR 1300 M 5EAA/5EAB/5EAC             | 00    | F |
| XJR 1300 5EA9/5EAG (298mm front disc) | 00    | F |
| XJR 1300 N/P 5EAP/5EAR/5EAS/5EAT      |       | F |
| /5EAW/5EAV/5EAY (298mm front disc)    | 01-02 | F |
| XJR 1300 R/S 5WMA/5WM3/5WM5/5WM6      |       | F |
| /5WM7/5WM9                            | 03-04 | F |
| XJR 1300 T/W 5WMA/5WMC/5WMD/5WME      | 05-07 | F |
| XJR 1300 SP (L) 5EA5/5EA6/5EA8        | 99    | F |
| XJR 1300 SP (M) 5EAD/5EAE/5EAF        | 00    | F |
| XJR 1300 SP (N) 5EAL/5EAM/5EAN        | 01    | F |
| XV 1700 PCR                           | 03-05 | F |
| XV 1900 A Midnight Star               | 06-07 | F |

### Equivalents OE #

|              |              |              |
|--------------|--------------|--------------|
| 3JD W0046 00 | 4SV W0045 00 | 5SL W0045 00 |
| 3MA W0045 00 | 4XV W0045 00 |              |
| 3TJ W0045 00 | 5JJ W0045 00 |              |

### Competitor X Ref

| Dunlop | Ferodo | SBS | Vesrah |
|--------|--------|-----|--------|
| DP418  | FDB605 | 634 | VD-249 |

### MATERIAL AVAILABILITY AND PART NO.

| STD   | OPTIONS |   |     |          |
|-------|---------|---|-----|----------|
| FA    | HH      | R | MXS | GFA      |
| FA252 | FA252HH | - | -   | GFA252HH |

# FA254 59.75 x 57 x 8.0mm

**NOTE: Refit O/E  
shim & insulator)**

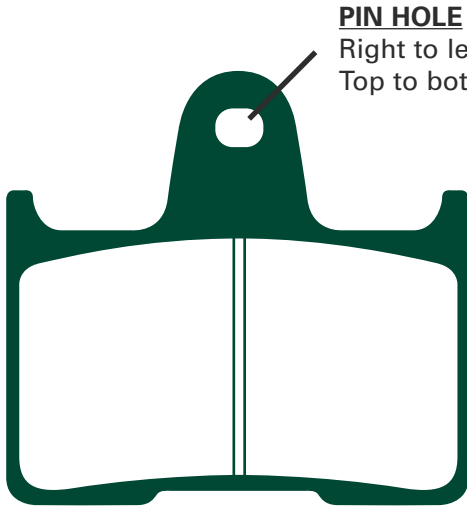

**PIN HOLE**  
Right to left 7.3mm  
Top to bottom 6.2mm

|                                       |         |
|---------------------------------------|---------|
| <b>HONDA</b>                          |         |
| CB 400 SFX/SFY/SF1/SF2/SF3 Super Four | 99-03 F |
| 'X4' CB 1300 DCV (5C38)               | 97- R   |
| CB 1300 FW/FX/FY/F1 (SC40)            | 98-01 R |
| <b>KAWASAKI</b>                       |         |
| ZX-7RR (ZX750 N1/N2)                  | 96-99 R |
| GTR 1400 (ZG 1400 A8F)                | 07 R    |
| ZZR 1400 (ZX 1400 A6F/A7F)            | 06-07 R |
| ZZR 1400 ABS (ZX 1400 B7F)            | 07 R    |
| <b>MZ/MUZ</b>                         |         |
| 1000 S                                | 03-07 R |
| 1000 SF                               | 05-07 R |
| 1000 SFX                              | 07 R    |
| 1000 ST                               | 07 R    |
| <b>SUZUKI</b>                         |         |
| GSXR 600 K4/K5                        | 04-05 R |
| GSF 650 K5/SK5 Bandit                 | 05 R    |
| GSXR 750 K4/K5                        | 04-05 R |
| GSXR 1000 K1/K2/K3/K4/K5/K6           | 01-06 R |
| GSF 1200 SSK1/ZK1 (GV78A)             | 02 R    |
| GSX 1400 K1/K2/K3/K4/K5/K6/K7         | 01-07 R |

**Equivalents OE #**

|               |             |               |
|---------------|-------------|---------------|
| 43082 1182    | 69100 40820 | 06435 MCE 006 |
| 43082 0055    | 69100 40840 |               |
| 06435 MAZ 006 | 69100 18810 |               |

**Competitor X Ref**

|                        |                         |                       |                        |
|------------------------|-------------------------|-----------------------|------------------------|
| <b>Dunlop</b><br>DP220 | <b>Ferodo</b><br>FDB211 | <b>SBS</b><br>715/765 | <b>Vesrah</b><br>VD436 |
|------------------------|-------------------------|-----------------------|------------------------|

**MATERIAL AVAILABILITY AND PART NO.**

| STD   | OPTIONS |   |     |     |
|-------|---------|---|-----|-----|
| FA    | HH      | R | MXS | GFA |
| FA254 | FA254HH | - | -   | -   |

# FA255 30.5 x 49 x 7.0mm

|                |         |
|----------------|---------|
| <b>PIAGGIO</b> |         |
| Sfera RST 50   | 95-97 F |
| Sfera 125      | 95-97 F |

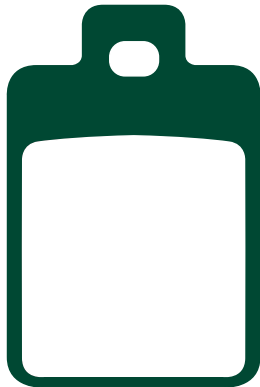

**Equivalents OE #**

|        |
|--------|
| 498846 |
|--------|

**Competitor X Ref**

|                    |                          |                   |                        |
|--------------------|--------------------------|-------------------|------------------------|
| <b>Dunlop</b><br>- | <b>Ferodo</b><br>FDB2037 | <b>SBS</b><br>712 | <b>Vesrah</b><br>VD955 |
|--------------------|--------------------------|-------------------|------------------------|

**MATERIAL AVAILABILITY AND PART NO.**

| STD   | OPTIONS |   |     |     |
|-------|---------|---|-----|-----|
| FA    | HH      | R | MXS | GFA |
| FA255 | -       | - | -   | -   |

# FA256 78.7 x 47 x 7.4mm

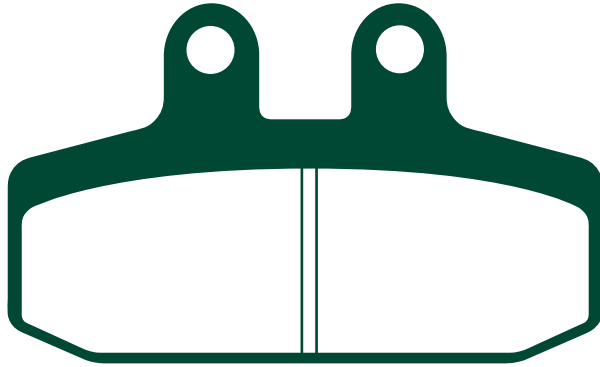

### Equivalents OE #

|                |               |               |               |
|----------------|---------------|---------------|---------------|
| 159 07 6340    | 45105 KR1 862 | 45105 KBS 405 | 06435 KBS W00 |
| 238 070 5 6340 | 45105 KR1 863 | 8000 88725    | 8113431       |
| 326 814        | 45105 KS3 901 | 8113865       | 06455 GAV 405 |
| 344839         | 45105 KS3 902 | 8133540       |               |
| 45105 KB9 960  | 45105 KY4 901 | 8133724       |               |
| 45105 KR1 861  | 45105 KY4 902 | 8133725       |               |

### Competitor X Ref

| Dunlop | Ferodo      | SBS     | Vesrah |
|--------|-------------|---------|--------|
| DP108  | FDB438/2146 | 588/793 | VD152  |

| MATERIAL AVAILABILITY AND PART NO. |         |         |   |     |     |
|------------------------------------|---------|---------|---|-----|-----|
| STD                                | OPTIONS |         |   |     |     |
| FA                                 | TT      | HH      | R | MXS | GFA |
| FA256                              | FA256TT | FA256HH | - | -   | -   |

|                              |       |   |  |
|------------------------------|-------|---|--|
| <b>APRILIA</b>               |       |   |  |
| Scarabeo 125/150/200         | 99-02 | F |  |
| Classic 125                  | 96-01 | F |  |
| Sport City 125/200           | 04-07 | F |  |
| Red Rose 125                 | 87-94 | F |  |
| Tuareg Rally 125 (L/M)       | 90-91 | F |  |
| Leonardo 250 ST/SP           | 00-04 | F |  |
| Sport City 250 ie            | 07    | F |  |
| Leonardo 300                 | 05-06 | F |  |
| Scarabeo 400 ie              | 07    | F |  |
| Atlantic 500                 | 02-04 | F |  |
| Scarabeo 500/500 AB3         | 03-06 | F |  |
| Scarabeo 500 Light           | 06    | F |  |
| Scarabeo 500 ie              | 07    | F |  |
| Scarabeo 125/200             | 03    | F |  |
| <b>CAGIVA</b>                |       |   |  |
| Blues 125                    | 92-95 | F |  |
| Roadster 125                 | 98-99 | F |  |
| <b>DERBI</b>                 |       |   |  |
| Boulevard S125               | 07    | F |  |
| <b>GARELLI</b>               |       |   |  |
| 50 Tiger XLE                 | 86-   | F |  |
| 125 Tiger XLE                | 86-   | F |  |
| <b>GILERA</b>                |       |   |  |
| Cougar 125                   | 99-02 | F |  |
| 125 XR1/XR2                  | 89-   | F |  |
| 200 Arizona Hawk             | 85-   | F |  |
| 200 RTX                      | 85-   | F |  |
| 200 ER                       | 87-   | F |  |
| 200 Fast Bike                | 87-   | F |  |
| RV 200 ES                    | 87-   | F |  |
| RC 250 Rally                 | 87-   | F |  |
| 350 Dakota                   | 85-   | F |  |
| ER 350                       | 87-   | F |  |
| XRT 350                      | 90-   | F |  |
| 500 Dakota                   | 87-   | F |  |
| ER 500                       | 87-   | F |  |
| XRT 600                      | 88-   | F |  |
| <b>HONDA</b>                 |       |   |  |
| SJ 50 P/R/S/T/V/W/X 'Bali'   | 93-99 | F |  |
| SJ 100 T/V/W/X 'Bali-Ex      | 96-99 | F |  |
| CA 125 V/W/X 'Rebel'         | 98-00 | F |  |
| CLR 125 W 'City Fly'         | 98-03 | F |  |
| CRM 125 RL/RM/RN/RP/RR/RV/RX | 90-99 | F |  |
| NS 125 FG/FH/RH              | 86-90 | F |  |
| NSR 125 FM/RK/RL/RM/RN/FP/RP |       |   |  |
| /RR/RV/RW/RX/RY/R1           | 91-04 | F |  |
| NX 125 K/S/F Transcity       | 89-97 | F |  |
| XL 125 L Paris-Dakar         | 85    | F |  |
| XL 200 L                     | 85    | F |  |
| CMX 250 CV/CW/CX 'Rebel'     | 97-00 | F |  |
| <b>MALAGUTI</b>              |       |   |  |
| Spider Max GT500             | 04-07 | F |  |
| <b>MOTO MORINI</b>           |       |   |  |
| 350 'Kanguro'                | 87    | F |  |

DISC PADS BUYERS GUIDE

# FA257 41.1 x 43 x 7.7mm

# FA257/2 41.1 x 43 x 5.3mm



|  |       |   |  |
|--|-------|---|--|
| <b>CAGIVA</b>  |       |   |  |
| City 50  | 91-94 | F |  |
| <b>DAELIM</b>  |       |   |  |
| 'S' Five (SJ50)  | 01-07 | F |  |
| E-Five (SJ50A)   | 03-06 | F |  |
| GZ 50 Message  | 97-02 | F |  |
| Delfino 100 (SH100)                                    | 01-04 | F |  |
| <b>GARELLI</b>   |       |   |  |
| Panther 125/150/250                                    | 02    | F |  |
| <b>HONDA</b>   |       |   |  |
| Tact 50  |       | F |  |
| SK 50 MM-II/MM-YD/MM-II/MP-II (AF28) Dio SR            |       |   |  |
| SK 50 MN-III/MP-III/MP-IV (AF28) Dio-ZX                |       |   |  |
| SK 50 MMR-II/MMP-II (AF28) Dio-XR                      |       |   |  |
| <b>SYM</b>   |       |   |  |
| Super Fancy 50   | 96-02 | F |  |
| City Hopper 50   | 99-02 | F |  |
| <b>FA257/2</b>   |       |   |  |
| FJS 600 1/2/A3/D3/A4/D4/A5/D5/A6/D6/A7 (Parking brake) | 01-07 |   |  |
| <b>GILERA</b>  |       |   |  |
| Fuoco 500 IE (Parking brake)                           | 07    |   |  |
| <b>PIAGGIO</b>   |       |   |  |
| MP3 125/250/400 (Parking brake)                        | 07    |   |  |

### Equivalents OE # FA257

|                  |                   |
|------------------|-------------------|
| 45105 GZ0 ACA    | 45105 G02 000     |
| 45112 GZ0 315    | 45105 SE5 5001E   |
| Y00 FA0112       | 45105 GAZ 5000 EU |
| 45105 G22 000 AC | 450105 GAZ 9800   |

### Equivalents OE # FA257/2

|               |
|---------------|
| 06436 MCT 006 |
| 648476        |

### Competitor X Ref

| Dunlop | Ferodo | SBS | Vesrah |
|--------|--------|-----|--------|
| -      | -      | 670 | VD162  |

| MATERIAL AVAILABILITY AND PART NO. |         |   |     |     |  |
|------------------------------------|---------|---|-----|-----|--|
| STD                                | OPTIONS |   |     |     |  |
| FA                                 | HH      | R | MXS | GFA |  |
| FA257                              | -       | - | -   | -   |  |
| FA257/2                            | -       | - | -   | -   |  |

# FA258 A. 26.10 x 119.55 x 7.1mm B. 35.60 x 94.54 x 7.80mm

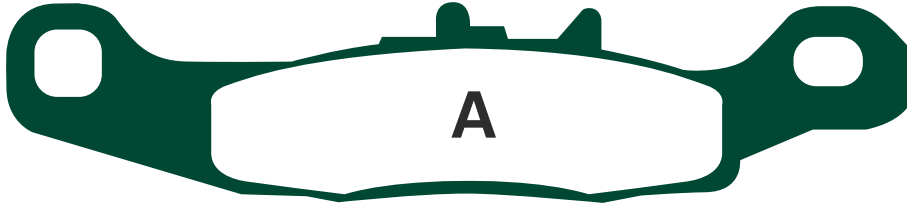
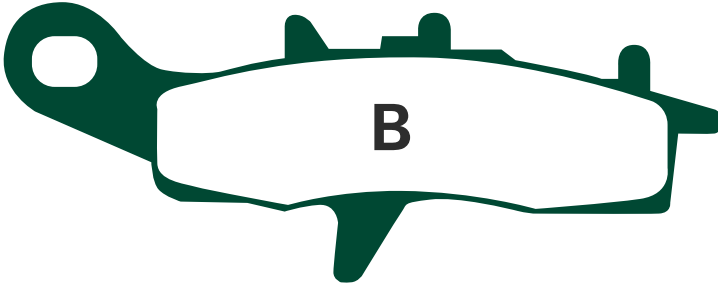

### KAWASAKI

|   |       |   |
|---|-------|---|
| KX 80 R7/W1/W2/W3                       | 97-00 | F |
| KX 85/85 II A1-A5/A6F/A7F/B1-B5/B6F/B7F | 01-07 | F |
| KX 100 B7/C1/C2/C3                      | 97-00 | F |
| KL 250 G1/G1A Super Sherpa              | 97    | F |
| KL 250 J1-J3 Stockman                   | 00-02 | F |
| KLX 250 H1 'Super Sherpa'               | 98    | F |

### SUZUKI

|                            |       |   |
|----------------------------|-------|---|
| RM 85 K5/LK5/K6/LK6/K7/LK7 | 05-07 | F |
| RM 100 K3                  | 03    | F |

### Equivalents OE #

|             |
|-------------|
| 43082 1196  |
| 43082 1206  |
| K4308-21196 |
| 59301 03820 |

### Competitor X Ref

| Dunlop | Ferodo | SBS | Vesrah |
|--------|--------|-----|--------|
| DP326  | -      | 726 | VD438  |

### MATERIAL AVAILABILITY AND PART NO.

| STD     | OPTIONS |        |     |     |
|---------|---------|--------|-----|-----|
| FA      | HH      | R      | MXS | GFA |
| FA258TT | -       | FA258R | -   | -   |

# FA259 USE FA231

# FA260 35.86 x 49 x 7.0mm



### CPI

|                |       |   |
|----------------|-------|---|
| GTR 50         | 03-07 | R |
| GTS 50/125/200 | 02-03 | R |
| GTR 50/125/200 | 02    | R |

### GENERIC

|          |    |   |
|----------|----|---|
| Toxic 50 | 07 | R |
|----------|----|---|

### GILERA

|                           |       |   |
|---------------------------|-------|---|
| DNA 50                    | 01-06 | R |
| 50 DD/SP Runner/Purejet   | 99-05 | R |
| SKP 50                    | 99-01 | R |
| Stalker 50                | 97-03 | R |
| Stalker 50                | 03-06 | R |
| Runner 50 PJ/SP           | 06-07 | R |
| 125/180 Runner All models | 99-04 | R |
| FUOCO 500 IE              | 07    | F |

### LML

|              |  |   |
|--------------|--|---|
| Star 125 DLX |  | F |
|--------------|--|---|

### PIAGGIO

|                                     |       |   |
|-------------------------------------|-------|---|
| NRG 50 RST "MC2"                    | 98    | R |
| Zip 50 RST                          | 96-99 | F |
| Zip 50 SP                           | 96-00 | F |
| Liberty 50 2T (Grimeca Caliper)     | 97-07 | F |
| Liberty 50 (Heng Tong Caliper) (2T) | 97-07 | F |
| NRG 50 Extreme                      | 99-01 | R |
| NRG 50 MC3 DD                       | 01-05 | R |
| NRG 50 DD                           | 06-07 | R |
| NRG 50 Pure Jet                     | 06-07 | R |
| Zip 50 Grimeca caliper              | 00-07 | F |
| Zip 50 SP (Liquid Cooled)           | 01-04 | F |
| Liberty 50 4T (Grimeca caliper)     | 00-07 | F |
| Liberty 50 4T (Heng Tong caliper)   | 00-07 | F |
| Liberty S 50 (2T/4T)                | 07    | F |
| Zip 100                             | 07    | F |
| Liberty 125/200                     | 98-07 | F |
| Liberty S125                        | 07    | F |
| Zip 125                             | 00-04 | F |
| MP3 125 (All models)                | 06-07 | F |
| Liberty S 200                       | 07    | F |
| MP3 250 ie (All models)             | 06-07 | F |
| MP3 400 ie (All models)             | 07    | F |

### VESPA

|                                |       |   |
|--------------------------------|-------|---|
| Vespa ET2 50                   | 97-05 | F |
| Vespa ET4 50 (Grimeca caliper) | 00-04 | F |
| Vespa ET4 125                  | 96-99 | F |
| Vespa ET4 125/150              | 99-05 | F |
| Vespa ET4 (Heng Tong Caliper)  | 00-04 | F |
| LX 50 (2T&4T)                  | 05-07 | F |
| LXV 50                         | 07    | F |
| LX 125/150 (4T)                | 05-07 | F |
| LXV 125                        | 07    | F |

### Equivalents OE #

|        |        |        |
|--------|--------|--------|
| 494097 | 498846 | 647157 |
| 494938 | 494938 | 647073 |

### Competitor X Ref

| Dunlop | Ferodo  | SBS | Vesrah |
|--------|---------|-----|--------|
| DP635  | FDB2057 | 724 | N/A    |

### MATERIAL AVAILABILITY AND PART NO.

| STD   | OPTIONS |   |     |     |
|-------|---------|---|-----|-----|
| FA    | HH      | R | MXS | GFA |
| FA260 | FA260HH | - | -   | -   |

# FA261HH 115.60 x 41 x 8.30mm (& shim)

Linked Brake - fit all three sets at pad change

# FA261/2HH 115.60 x 41 x 11.50mm (& shim)



A



B

### Equivalents OE # FA261HH

|               |               |
|---------------|---------------|
| 06435 MAJ G41 | 06455 MCA 006 |
| 06435 MAT 006 | 06455 MCC 006 |
| 06435 MCC 006 | 06455 MCH 006 |
| 06435 MCH 006 | 06455 MBG 005 |
| 06435 MBL D01 | 06455 MBT 611 |
| 06435 MCS G01 | 06455 MCS G01 |
| 06435 MBL D01 | 06455 MCT 691 |
| 06455 MAJ G41 | 06456 MCA 006 |
| 06455 MAT 006 | 06456 MCC 006 |
| 06455 MAT E21 |               |

### Equivalents OE # FA261/2HH

06435 MCA 006

### Competitor X Ref

| Dunlop             | Ferodo  | SBS     | Vesrah |
|--------------------|---------|---------|--------|
| DP124/5/6<br>DP128 | FDB2073 | 721/722 | VD165  |

| MATERIAL AVAILABILITY AND PART NO. OPTIONS |    |         |   |     |     |
|--|----|---------|---|-----|-----|
| STD  | FA | HH      | R | MXS | GFA |
| -  | -  | FA261HH | - | -   | -   |

| MATERIAL AVAILABILITY AND PART NO. OPTIONS |    |           |   |     |     |
|--|----|-----------|---|-----|-----|
| STD  | FA | HH        | R | MXS | GFA |
| -  | -  | FA261/2HH | - | -   | -   |

### HONDA - FA261HH

|   |       |     |
|---|-------|-----|
| FJS 400 D6 Silverwing                           | 06    | F   |
| NT 650 V2/V3/V4/V5                              | 02-05 | F&R |
| NT 700 V6/VA7 Deauville                         | 06-07 | R   |
| VFR 800 FiW/FiX/FiY/Fi1/2/3/4/5/A2/A3/A4/A5     | 98-05 | F&R |
| VFR 800 6/7/A6/A7                               | 06-07 | R   |
| XL 1000 VX/VY/V1/V2/V3/V4/V5/V6 'Varadero'      | 99-06 | F&R |
| XL 1000 A4/VA4/VA5/VA6/VA7 Varadero             | 04-07 | R   |
| CB 1100 SFY/SF1 "XII"                           | 00-04 | F&R |
| CBR 1100 XXV/XXW/XXX/XXY/XX1/XX2/XX3            |       |     |
| /XX4/XX5/XX6 'Blackbird'                        | 97-07 | F&R |
| ST 1100 AT/AV/AW/AX/AY/A1                       |       |     |
| 'Pan European'                                  | 96-01 | F&R |
| ST 1300 2/A2/3/A3/4/A4/5/A5/6/A6 'Pan European' | 02-06 | F&R |
| GL 1800 A1/A2/A3/A4/A5/A6/A7 "Goldwing"         | 01-07 | F   |
| VTX 1800 C2/C3/C4/C15                           | 02-05 | F&R |

### HONDA - FA261/2HH

|               |       |   |
|---------------|-------|---|
| GL 1800 A1-A7 | 02-07 | R |
|---------------|-------|---|

# GFA263HH 100.5 x 34 x 9mm

LOCKHEED SIX PISTON CALIPER (4466/67 Type)

PFM 6 Piston Superbike caliper

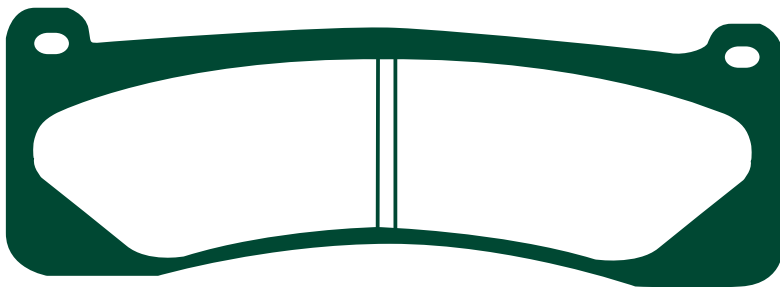

RACE USE ONLY

### Equivalents OE #

4466 / 4477

### Competitor X Ref

| Dunlop | Ferodo             | SBS | Vesrah |
|--------|--------------------|-----|--------|
| RDP629 | FDB2043<br>FDB2167 | 707 | -      |

| MATERIAL AVAILABILITY AND PART NO. OPTIONS |    |    |   |     |          |
|--|----|----|---|-----|----------|
| STD  | FA | HH | R | MXS | GFA      |
| -  | -  | -  | - | -   | GFA263HH |

# FA264

A. 85.1 x 42.9 x 8.2mm  
B. 69.8 x 41 x 8.2mm

**Equivalents OE #**

|                  |                  |                  |
|------------------|------------------|------------------|
| 45105 H13 000 AC | Y00FA1409        | 45106 SB3 0001M1 |
| 45105 G22 000 AC | 413612           |                  |
| 45105 G02 000 AS | 45105 SB3 0001M1 |                  |

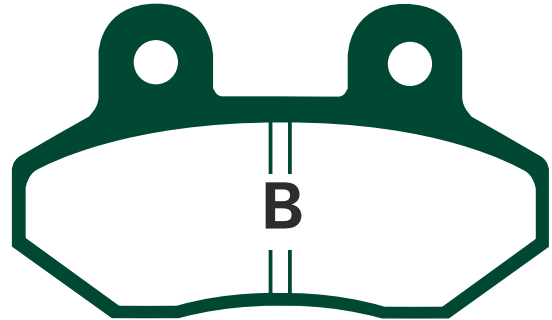
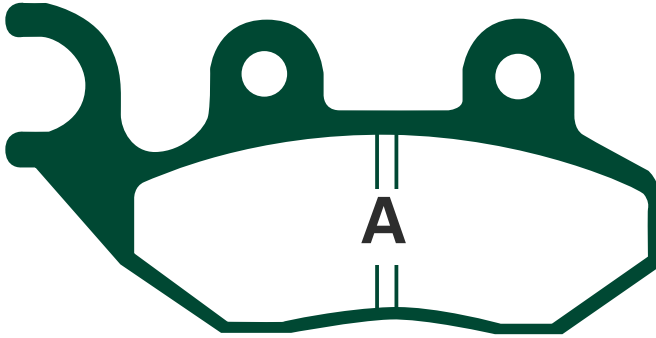

**CAGIVA**

|             |       |     |
|-------------|-------|-----|
| Stella 50   | 97    | F&R |
| Passing 125 | 93-97 | F   |

**DAELIM**

|                       |       |   |
|-----------------------|-------|---|
| SJ 50 R A-Four (50cc) | 06-07 | F |
|-----------------------|-------|---|

**GARELLI**

|                  |    |   |
|------------------|----|---|
| KRS 50           |    | F |
| Joker 125/150    | 02 | F |
| Freeland 125/150 |    | F |

**PGO**

|                    |       |   |
|--------------------|-------|---|
| Big Max 50 S       | 03-04 | F |
| G-Max 50           | 05-07 | F |
| TR-3 50 (Trike)    | 03-04 | F |
| My Bubu 100/125    | 03-05 | F |
| T/Rex All models   | 99-06 | F |
| Charge 125 A/B     | 00-02 | F |
| i-Charge 125       | 03-05 | F |
| PMX 50/110         | 00-07 | F |
| Young Bubu 100/125 | 03-05 | F |
| Ligero 125         | 06    | F |

**SYM**

|                         |       |   |
|-------------------------|-------|---|
| Mask 50                 | 00-05 | F |
| Jet Basix 50            | 06-07 | F |
| Jet 50/Euro XS          | 99-05 | F |
| Jet Euro X 50/100       | 06-07 | F |
| Jet Sport X 50 (R/S/SR) | 06-07 | F |
| Red Devil 50            | 99-05 | F |
| Jungle 50               | 99-02 | F |
| Jet 100 (G100P-6)       | 99-00 | F |
| Attila 125              | 99-00 | F |
| HD 125 S Evo            | 07    | F |
| Super Duke 125/150      | 99-00 | F |
| Megalo 125              | 00-06 | F |
| H 200 SE                | 06    | F |
| HD 200 S Evo            | 07    | F |

**TGB**

|   |       |   |
|---|-------|---|
| Akros Tec (50)                            | 03-04 | F |
| Delivery 50 Scooter (Up to E/F No 609099) | 04-05 | F |
| 202 Classic                               | 03-04 | F |
| 101 R (50/125/150)                        | 05-06 | F |
| 203                                       | 05-06 | F |
| Platform (50/125/150)                     | 06    | F |

**Competitor X Ref**

| Dunlop | Ferodo  | SBS | Vesrah |
|--------|---------|-----|--------|
| -      | FDB2190 | 708 | VD9012 |

**MATERIAL AVAILABILITY AND PART NO.**

| STD   | OPTIONS |   |     |     |
|-------|---------|---|-----|-----|
| FA    | HH      | R | MXS | GFA |
| FA264 | -       | - | -   | -   |

# FA265HH

74.75 x 55.4 x 8.1mm (with fitted shim)

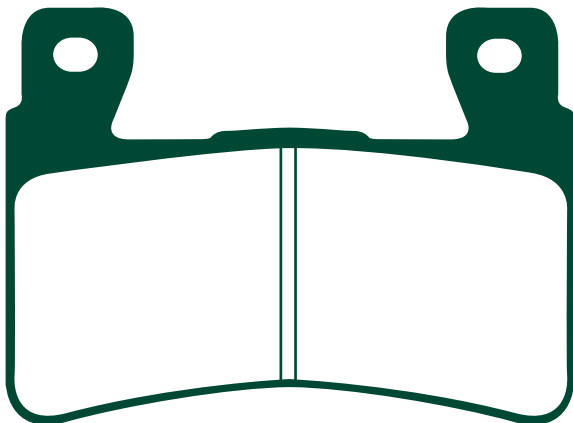

**Equivalents OE #**

|               |               |
|---------------|---------------|
| 06455 MAS E01 | 06455 MBW E11 |
| 06455 MCF 006 | 06455 MFA D11 |

**HONDA**

|   |       |   |
|---|-------|---|
| CBR 900 RRW/RRX/RRY/RR1/RR2/RR3 'Fireblade' | 98-03 | F |
| VTR 1000 SPY/SP1 (SC45)                     | 00-01 | F |
| VTR 1000 SP-2/SP-3/SP-4/SP-5/SP-6           | 02-06 | F |
| CB 1300 F1 (SC40)                           | 01    | F |

**Competitor X Ref**

| Dunlop | Ferodo  | SBS | Vesrah  |
|--------|---------|-----|---------|
| DP127  | FDB2079 | 734 | VD166/2 |

**MATERIAL AVAILABILITY AND PART NO.**

| STD | OPTIONS |   |     |          |
|-----|---------|---|-----|----------|
| FA  | HH      | R | MXS | GFA      |
| -   | FA265HH | - | -   | GFA265HH |



# FA266 54.05 x 50.90 x 7.50mm

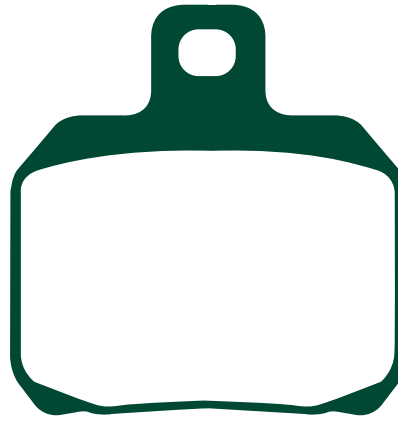

|   |               |     |  |
|---|---------------|-----|--|
| <b>APRILIA</b>                                  |               |     |  |
| RS 50   | 07            | F   |  |
| RSV 1000 (All models)                           | 98-07         | R   |  |
| SL 1000 Falco                                   | 00-04         | R   |  |
| ETV 1000 Caponard/Raid/ABS                      | 01-07         | R   |  |
| 1000 (Tuono/Factory)                            | 02-07         | R   |  |
| <b>BENELLI</b>                                  |               |     |  |
| 2-UE (750cc)                                    | 07            | R   |  |
| TNT 899 Tornado Naked Tre                       | 07            | R   |  |
| Trek 899  | 07            | R   |  |
| Tornado 900                                     | 02            | R   |  |
| Tornado LE/Tre Novecento/RS                     | 03-05         | R   |  |
| TNT 1130 Sport/Sport Evo                        | 04-07         | R   |  |
| TNT 1130 Cafe Racer                             | 05-07         | R   |  |
| TNT 1130 Titanium                               | 05-06         | R   |  |
| TRE-K 1130                                      | 06-07         | R   |  |
| Trek 1130 Amazonas                              | 07            | R   |  |
| Tornado TRE1130 (Radial caliper)                | 06-07         | R   |  |
| Tornado Naked TRE TNT 1130                      | 06-07         | R   |  |
| <b>BIMOTA</b>                                   |               |     |  |
| Elirio  | 06            | R   |  |
| DB5 (All models)                                | 06-07         | R   |  |
| DB5R  | 06-07         | R   |  |
| DB6 Delirio 992cc Ducati engine)                | 07            | R   |  |
| <b>BOMBARDIER</b>                               |               |     |  |
| Traxter (4x4)                                   | 99-01         | F&R |  |
| <b>BREMBO</b>                                   |               |     |  |
| 20 6950 51 (P32G) Single pad fixing 2 piston    |               |     |  |
| 20 6951 50/45 (P34G) Single pad fixing 2 piston |               |     |  |
| <b>CAGIVA</b>                                   |               |     |  |
| Raptor/V-Raptor 650                             | 00-07         | R   |  |
| 1000 Raptor/V-Raptor                            | 00-05         | R   |  |
| <b>CPI</b>                                      |               |     |  |
| X-Large 125/150/200                             | 02-03         | F&R |  |
| GTR 50  | 03-07         | F   |  |
| <b>DERBI</b>                                    |               |     |  |
| GPR 50/Nude/ST (Radial Caliper)                 | 04-07         | F   |  |
| Senda 50 DRD Pro SM Supermoto                   | 05-07         | F   |  |
| Senda 50 DRD Pro R Enduro                       | 05-07         | F   |  |
| GRP 80 Cup (Radial Caliper)                     | 04-05         | F   |  |
| GP 125  | 06-07         | F&R |  |
| GPI 150   | 05            | F   |  |
| GPI 250   | 06-07         | F   |  |
| GPI 250i  | 07            | F   |  |
| GPI Scooter (Radial caliper) "Euro 2"           | Mar 05-Dec 05 | F   |  |
| Mulhacen 659                                    | 06-07         | R   |  |
| Mulhacen 659 Hot Bob                            | 07            | R   |  |
| Mulhacen 659 Cafe                               | 07            | R   |  |
| Mulhacen 659 X Vision                           | 07            | R   |  |
| GPX1  | 06            | F   |  |
| GPI 250   | 06-07         | R   |  |
| <b>DUCATI</b>                                   |               |     |  |
| Monster 620 Catwoman                            | 05            | R   |  |
| Multistrada 620 Dark                            | 05-06         | R   |  |
| 749/749 S/749 R                                 | 03-06         | R   |  |
| 749 Dark  | 04-06         | R   |  |
| 750 Supersport                                  | 99            | R   |  |
| 750 Supersport IE                               | 00-02         | R   |  |
| 750 Sport                                       | 01-02         | R   |  |
| 800 Supersport                                  | 03-04         | R   |  |
| 900 Supersport                                  | 98-99         | R   |  |
| 900 Supersport IE                               | 00-01         | R   |  |
| 900 Sport                                       | 02            | R   |  |
| 900 MH Evoluzione                               | 00-01         | R   |  |
| Desmosedici RR (D16RR) (989cc)                  | 07            | R   |  |
| Sport Touring ST4-916cc                         | 99-03         | R   |  |
| Sport Touring ST2-944cc                         | 97-02         | R   |  |
| Sport Touring ST4S 996cc                        | 01-05         | R   |  |
| Sport Touring 996cc ST4S-ABS                    | 03-05         | R   |  |
| Monster S4R (996cc)                             | 03-06         | R   |  |
| STS 3 (992cc)                                   | 04-05         | R   |  |
| ST3S (ABS Model)                                | 06-07         | R   |  |
| 999/999 S/999 R                                 | 03-06         | R   |  |
| Multi Strada 1000 DS/1000 SDS                   | 03-06         | R   |  |
| 1000 Supersport DS                              | 03-06         | R   |  |
| 999 R (Xerox)                                   | 06            | R   |  |
| 1098/1098 S/1098 Tricolore                      | 07            | R   |  |
| Hypermotard                                     | 07            | R   |  |
| Multistrada 1100/1100 S (1078cc)                | 07            | R   |  |
| <b>GILERA</b>                                   |               |     |  |
| Nexus 500                                       | 03-07         | R   |  |
| <b>KEEWAY</b>                                   |               |     |  |
| Silverblade 125/150/250                         | 07            | R   |  |
| <b>LAVERDA</b>                                  |               |     |  |
| SFC 1000  | 03-04         | R   |  |
| <b>MALAGUTI</b>                                 |               |     |  |
| NKD 50 Drakon                                   | 05-07         | F   |  |
| Drakon S  | 06            | F   |  |
| <b>MBK</b>                                      |               |     |  |
| XQ 125/150 Thunder                              | 01-03         | R   |  |
| YP 125 D Skyliner                               | 00-06         | R   |  |
| XP 125 Skycruiser                               | 06            | R   |  |
| <b>MONDIAL</b>                                  |               |     |  |
| Piega 1000                                      | 03-04         | R   |  |
| EVO   | 04            | R   |  |
| <b>MOTO GUZZI</b>                               |               |     |  |
| 1100 California EV                              | 98-00         | R   |  |
| Nevada 750 (Club)                               | 98-04         | R   |  |
| Nevada Classic 750 ie                           | 05-07         | R   |  |

|  |       |     |
|--|-------|-----|
| Nevada 750 Touring                       | 07    | R   |
| V 750 ie Brevia                          | 03-07 | R   |
| MGS-01                                   | 03-04 | R   |
| MGS-01 Corsa                             | 07    | R   |
| V 1100 Brevia                            | 04    | R   |
| Fionda 1100                              | 05    | R   |
| <b>MOTO MORINI</b>                       |       |     |
| Corsaro 1200                             | 05-06 | R   |
| Corsaro 1200 Veloce                      | 07    | R   |
| 9 1/2 (998cc)                            | 06    | R   |
| MM3 (1187cc)                             | 07    | R   |
| <b>PETRONAS</b>                          |       |     |
| FP1                                      | 05    | R   |
| <b>PIAGGIO</b>                           |       |     |
| X8 125                                   | 04-05 | R   |
| X9 125                                   | 00-02 | F&R |
| X9 125 Evolution                         | 03-05 | F&R |
| X9 180 Amalfi                            | 00-03 | F&R |
| X8 200                                   | 04-05 | R   |
| X9 200                                   | 02-03 | F&R |
| X9 200 Evolution                         | 03-04 | F&R |
| X9 250/250 SL                            | 00-04 | F&R |
| X9 250 Linked brake f&r<br>wheel 14" dia | 04    | R   |
| Beverley B500                            | 02-04 | F&R |
| Beverley 500                             | 06    | F   |
| Beverley Cruiser 500 ie                  | 07    | F&R |
| X9 500/500 SL                            | 00-02 | F&R |
| X9 500cc Evolution (inc ABS)             | 03-06 | R   |
| X9 500 ie                                | 07    | R   |
| <b>RIEJU</b>                             |       |     |
| Tango 125                                | 06-07 | F   |
| <b>SUZUKI</b>                            |       |     |
| UH 125 K2/K3/K4/K5/K6 Burgman            | 02-06 | R   |
| <b>TOMOS</b>                             |       |     |
| SM 125                                   | 05    | F   |
| <b>VOXON</b>                             |       |     |
| Cafe Racer                               | 06    | R   |
| Roadster                                 | 06    | R   |
| <b>YAMAHA</b>                            |       |     |
| XQ 125/150 Maxster                       | 01-03 | R   |
| YP 125 Majesty                           | 01-07 | R   |
| YP 125 X-Max                             | 06-07 | R   |
| YP 180 Majesty                           | 06    | R   |
| <b>VOXAN</b>                             |       |     |
| Cyclope 1000                             | 02    | R   |
| Cafe Racer 1000                          | 02-05 | R   |
| Roadster 1000                            | 02-05 | R   |
| Black Magic                              | 04-05 | R   |
| Street Scrambler                         | 03-05 | R   |
| VB1-Evo                                  | 03-04 | R   |

### Equivalents OE #

|              |               |              |
|--------------|---------------|--------------|
| 613 4 021 1A | 497083        | 107 694 936  |
| 8113751      | 69130 49F00   | 862489       |
| 8113898      | R180100127000 | 862698       |
| 494966       | 497394        | 861760       |
| 613 403 81A  | 09130 07E00   | 647077       |
| 5NR F5811 00 | R44422001A    | 5NR F5811 10 |
| 8000 95280   | 8133542       |              |

### Competitor X Ref

| Dunlop | Ferodo  | SBS | Vesrah |
|--------|---------|-----|--------|
| DP631  | FDB2074 | 730 | -      |

| MATERIAL AVAILABILITY AND PART NO. |         |        |     |     |
|------------------------------------|---------|--------|-----|-----|
| STD                                | OPTIONS |        |     |     |
| FA                                 | HH      | R      | MXS | GFA |
| FA266                              | FA266HH | FA266R | -   | -   |

# FA267 51.85 x 59.75 x 8.90mm

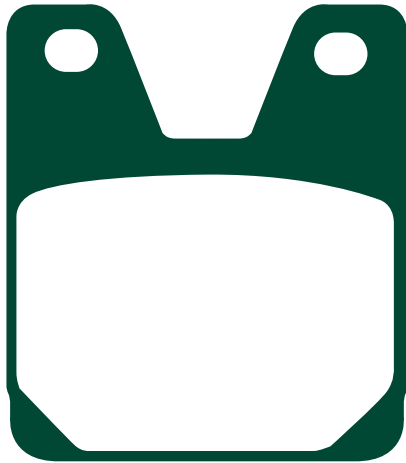

## YAMAHA

|  |       |   |
|--|-------|---|
| YZF 1000 R1                                | 98-00 | R |
| YZF R7 750 'OWO2' Road version             | 99-00 | R |
| XJR 1300 (5EA9/5EAG)<br>(298mm front disc) | 00    | R |

### Equivalents OE #

|              |
|--------------|
| 4XV W0046 00 |
| 4XV W0046 10 |
| 5EA W0046 50 |
| 5FL W0046 50 |

### Competitor X Ref

| Dunlop | Ferodo  | SBS | Vesrah |
|--------|---------|-----|--------|
| DP419  | FDB2084 | 733 | VD264  |

### MATERIAL AVAILABILITY AND PART NO.

| STD   | OPTIONS |   |     |     |
|-------|---------|---|-----|-----|
| FA    | HH      | R | MXS | GFA |
| FA267 | FA267HH | - | -   | -   |

# FA268 45.80 x 52.80 x 6.50mm



## YAMAHA

|               |       |   |
|---------------|-------|---|
| YQ 50 Aerox R | 97-07 | R |
| EW 50 Slider  | 00-05 | F |

## MBK

|                   |       |   |
|-------------------|-------|---|
| EW 50 Stunt       | 00-06 | F |
| YQ 50 Nitro       | 97-06 | R |
| EW 50 Stunt Naked | 05-06 | F |

### Equivalents OE #

5BR F5811 00

### Competitor X Ref

| Dunlop         | Ferodo  | SBS | Vesrah |
|----------------|---------|-----|--------|
| DP013<br>DP422 | FDB2062 | 731 | -      |

### MATERIAL AVAILABILITY AND PART NO.

| STD   | OPTIONS |   |     |     |
|-------|---------|---|-----|-----|
| FA    | HH      | R | MXS | GFA |
| FA268 | -       | - | -   | -   |

# FA269 use FA234

# FA270 73.85 x 52.8 x 6.82mm

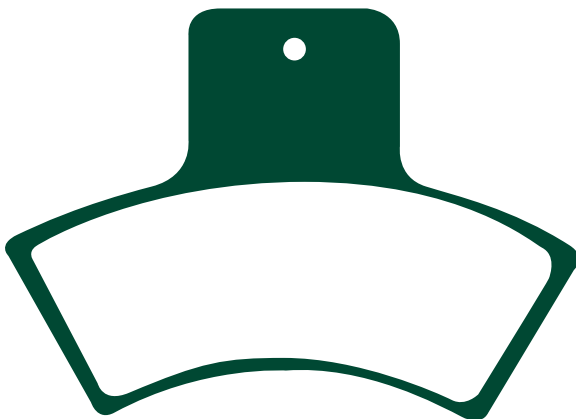

## POLARIS

Most models 98 onwards. Check application pages for fitment details.

## QUADZILLA

|                         |       |   |
|-------------------------|-------|---|
| Quadzilla 300 "Utility" | 04-06 | R |
| 300 E SUV               | 06    | R |
| 300 E (4x4) (Auto)      | 06-07 | R |
| 400 4x4                 | 06-07 | R |

### Equivalents OE #

|         |         |
|---------|---------|
| 1910339 | 2201189 |
| 1930860 | 2201399 |
| 1910333 | 2201732 |
| 2201093 | 22111   |

### Competitor X Ref

| Dunlop | Ferodo  | SBS | Vesrah |
|--------|---------|-----|--------|
| DP915  | FDB2121 | 755 | -      |

### MATERIAL AVAILABILITY AND PART NO.

| STD     | OPTIONS |        |     |     |
|---------|---------|--------|-----|-----|
| FA      | HH      | R      | MXS | GFA |
| FA270TT | -       | FA270R | -   | -   |

# FA271 67.6 x 43.95 x 7.7mm

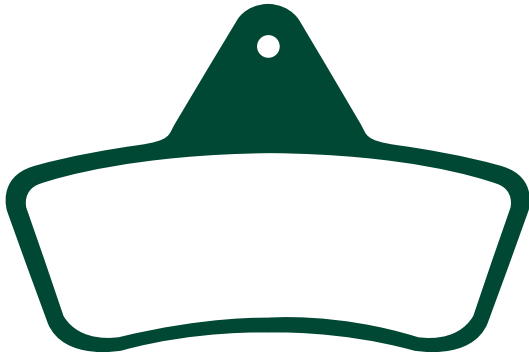

### ARCTIC CAT

Most models 96-04 F&R  
Check application fitment details

### LAVERDA

Quasar 4x4 500c 04 F&R  
Quasar 4x4 500 04 F&R  
Quasar 4x4 400 04 F&R

### MASSEY FERGUSON (ATV)

MF 250 (2WD/4WD) 04 F&R  
MF 300 (2WD/4WD) 04 F&R  
MF 400 4WD 04 F&R  
MF 400 Auto 4WD 04 F&R  
MF 500 (Auto 4WD) TBX Auto 04 F&R

### Equivalents OE #

|          |          |          |          |
|----------|----------|----------|----------|
| 0502 019 | 0402 096 | 0402 494 | 0402 882 |
|----------|----------|----------|----------|

### Competitor X Ref

| Dunlop | Ferodo  | SBS | Vesrah |
|--------|---------|-----|--------|
| DP914  | FDB2175 | 758 | -      |

| MATERIAL AVAILABILITY AND PART NO. |         |        |     |     |
|------------------------------------|---------|--------|-----|-----|
| STD                                | OPTIONS |        |     |     |
| FA                                 | HH      | R      | MXS | GFA |
| FA271TT                            | -       | FA271R | -   | -   |

# FA272 39.6 x 44.4 x 7mm



### AP LOCKHEED

Caliper no. CP4226.4 R

### Equivalents OE #

|          |
|----------|
| CP4226-4 |
|----------|

### Competitor X Ref

| Dunlop | Ferodo | SBS | Vesrah |
|--------|--------|-----|--------|
| -      | -      | 719 | -      |

| MATERIAL AVAILABILITY AND PART NO. |         |   |     |     |
|------------------------------------|---------|---|-----|-----|
| STD                                | OPTIONS |   |     |     |
| FA                                 | HH      | R | MXS | GFA |
| FA272                              | -       | - | -   | -   |

# FA273R 60.7 x 50.3 x 12.3mm

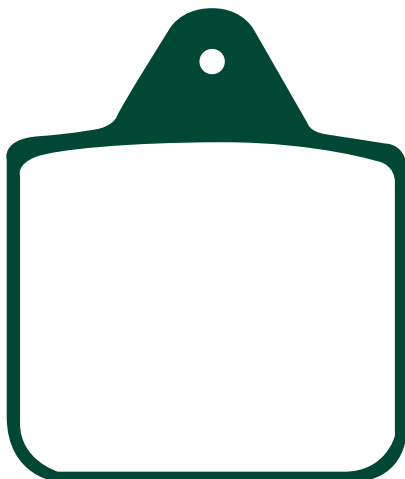

### POLARIS

Big Boss 400 L 6x6 96  
Big Boss 425 6x6 96 Middle Axle Brake  
ranger 99 R

### Equivalents OE #

|         |
|---------|
| 2200807 |
|---------|

### Competitor X Ref

| Dunlop | Ferodo  | SBS | Vesrah |
|--------|---------|-----|--------|
| -      | FDB2135 | 756 | -      |

| MATERIAL AVAILABILITY AND PART NO. |         |        |     |     |
|------------------------------------|---------|--------|-----|-----|
| STD                                | OPTIONS |        |     |     |
| FA                                 | HH      | R      | MXS | GFA |
| -                                  | -       | FA273R | -   | -   |

# FA275 99.77 x 30.2 x 9mm

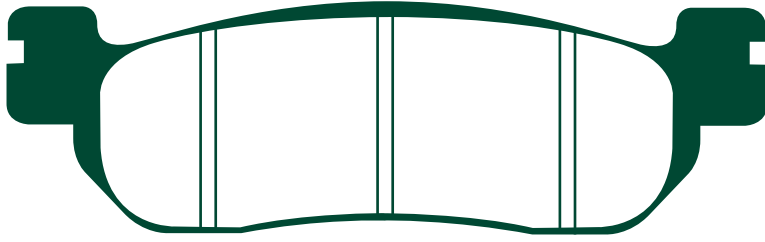

|                                    |       |      |
|------------------------------------|-------|------|
| <b>YAMAHA</b>                      |       |      |
| RZ 50 (5FC1/2)                     | 02    | F    |
| T 105 E (5ER1/2) Crypton-R         | 99    | F    |
| T 105 SE Crypton (5EA3)            | 02    | F    |
| V 110 ZE/ZK/ZHE/ZHK                |       |      |
| FIZR/FIZR Sport                    | 96    | F    |
| TW 125                             | 99-04 | F    |
| TW 200 (2JL/4CS1/2/3/4/5/6/5LB1/2) | 01-02 | F    |
| ST 225 (5BT) Bronco                | 97    | F    |
| TW 225 E (5VC1/2)                  | 03    | F    |
| Serrow 250 (3C51/52)               | 05    | F VP |
| 250 W (X-City)                     | 07    | R    |
| XG 250 Tricker (5XT1)              | 04-06 | F    |
| YP 250 (X-Max)                     | 05-07 | R    |
| XT 250 X                           | 06    | F    |
| YP 250 DX/A Majesty                | 98-03 | R    |
| YZF 600 R 'R6'                     | 99-02 | R    |
| YZF 1000 R1                        | 02-03 | R    |
| <b>MBK</b>                         |       |      |
| YP 250 Skyliner 250 (+ABS)         | 98-02 | R    |
| <b>ITALJET</b>                     |       |      |
| Jupiter 125/150                    | 02    | R    |

**Equivalents OE #**

|               |              |
|---------------|--------------|
| 4730480       | 5EK W0045 10 |
| 4JG W0045 00  | 5EB W0046 00 |
| 4US W0045 00  | 5GM W0046 00 |
| 3 YR W0045 00 | 5PW W0046 50 |
| 5CG W0046 00  | 5LB W0045 00 |
| 5CG W0046 20  | 5XT W0045 00 |

**Competitor X Ref**

|               |               |            |               |
|---------------|---------------|------------|---------------|
| <b>Dunlop</b> | <b>Ferodo</b> | <b>SBS</b> | <b>Vesrah</b> |
| DP420         | FDB2083       | 728        | VD265         |

| MATERIAL AVAILABILITY AND PART NO. |         |   |     |     |
|------------------------------------|---------|---|-----|-----|
| STD                                | OPTIONS |   |     |     |
| FA                                 | HH      | R | MXS | GFA |
| FA275                              | FA275HH | - | -   | -   |

# GFA276HH 95.8 x 47.5 x 8.4mm

**Race use only**

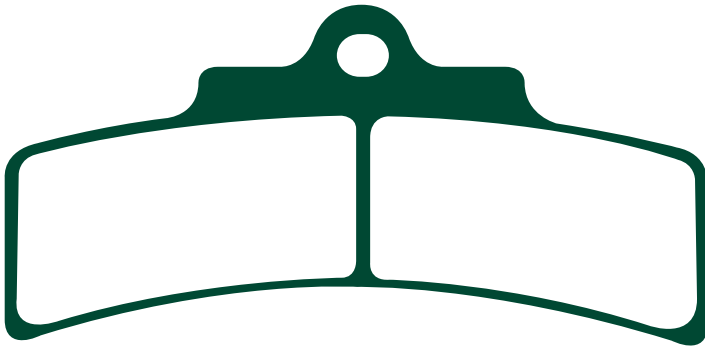

**PVM**  
6 piston

**Equivalents OE #**

|   |
|---|
| - |
|---|

**Competitor X Ref**

|               |               |            |               |
|---------------|---------------|------------|---------------|
| <b>Dunlop</b> | <b>Ferodo</b> | <b>SBS</b> | <b>Vesrah</b> |
| -             | -             | -          | VD9027        |

| MATERIAL AVAILABILITY AND PART NO. |         |   |     |          |
|------------------------------------|---------|---|-----|----------|
| STD                                | OPTIONS |   |     |          |
| FA                                 | HH      | R | MXS | GFA      |
| -                                  | -       | - | -   | GFA276HH |

# FA281 115.6 x 41 x 9.3mm

**Equivalents OE #**

|               |
|---------------|
| 06455 KFG 016 |
| 06455 KFG 641 |
| 06455 KPB 406 |
| 119 481 00    |
| 754808        |

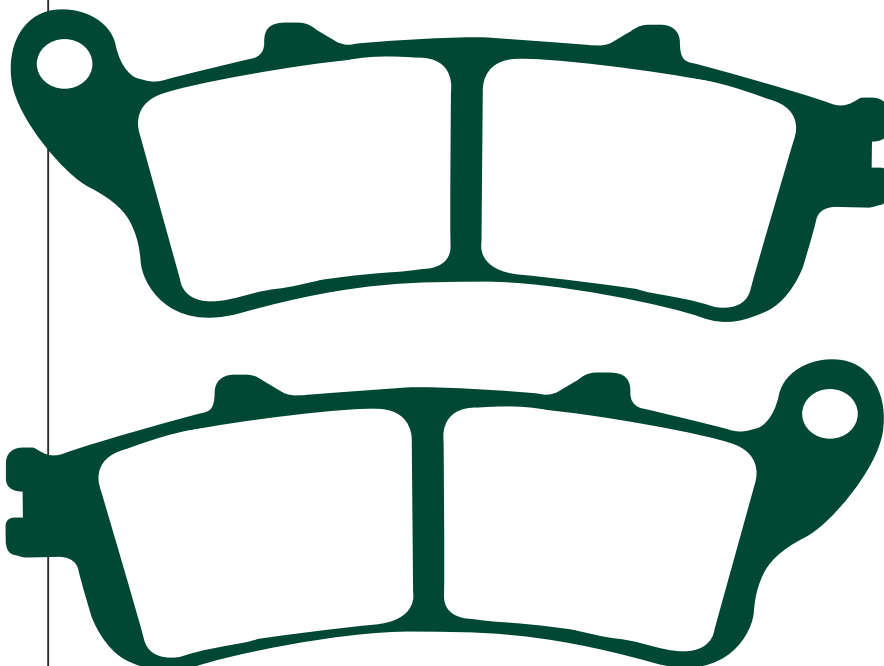

**GARELLI**

Skyнет 250/400 02 F

**HONDA**

FES 125 W/Y/1/2/3/4/5/6/7 Pantheon 98-07 F

FES 150 W/Y/1/2/3/4/5 Pantheon 98-06 F

FES 250 W/X/Y/1/2/5 Foresight 98-05 F

NSS 250 Y/AY/1/A1/A3/3 Forza/Forza-S /Forza-T/Forza-ST/Jazz/Reflex (MF04/MF06) 00-04 F

FJS 400 2 (NF01) Silverwing 400 01-02 F

FJS 400 D6 Silverwing 06 F

600 Silverwing Scooter FJS 600 1/2/A3/D3 /A4/D4/A5/D5/A6/D6/A7 01-07 F

**PEUGEOT**

SV 250 01-02 F

**Competitor X Ref**

| MATERIAL AVAILABILITY AND PART NO. |         |   |     |     |
|------------------------------------|---------|---|-----|-----|
| STD                                | OPTIONS |   |     |     |
| FA                                 | HH      | R | MXS | GFA |
| FA281                              | FA261HH | - | -   | -   |

|               |               |            |               |
|---------------|---------------|------------|---------------|
| <b>Dunlop</b> | <b>Ferodo</b> | <b>SBS</b> | <b>Vesrah</b> |
| DP124         | FDB2075       | 722        | -             |

# FA282R 31.25 x 35.85 x 5.12mm



## HUSQVARNA

Husky Boy 50

98-99 F&R

## HYOSUNG

TE 50

05-07 R

TE 90

05-07 R

TE 100

05-07 R

### Equivalents OE #

59300 21000

### Competitor X Ref

| MATERIAL AVAILABILITY AND PART NO. |         |        |     |     |
|------------------------------------|---------|--------|-----|-----|
| STD                                | OPTIONS |        |     |     |
| FA                                 | HH      | R      | MXS | GFA |
| -                                  | -       | FA282R | -   | -   |

| Dunlop | Ferodo | SBS | Vesrah |
|--------|--------|-----|--------|
| -      | -      | -   | -      |

# FA283 53.5 x 44.7 x 8.6mm

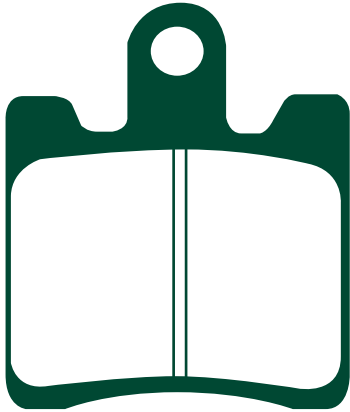

**NOTE:**  
2 sets  
required to  
replace one  
caliper set

## KAWASAKI

SC 250 A1 Epsilon

02-03 F

## SUZUKI

AN 250 W/X/Y Burgman

98-00 F

AN 250 K1/K2 Burgman

01-02 F

AN 400 X/Y/K1/K2 Burgman

99-02 F

AN 400 K3-K6

03-06 F

## SYM

GTS 250 Joymax

07 F

GT 500

04 F

### Equivalents OE #

|             |             |
|-------------|-------------|
| 59300 14870 | 59301 14810 |
| 59300 14880 | 59301 14820 |
| 43082 S002  |             |

### Competitor X Ref

| Dunlop | Ferodo  | SBS | Vesrah |
|--------|---------|-----|--------|
| DP219  | FDB2085 | 740 | VD353  |

| MATERIAL AVAILABILITY AND PART NO. |         |   |     |     |
|------------------------------------|---------|---|-----|-----|
| STD                                | OPTIONS |   |     |     |
| FA                                 | HH      | R | MXS | GFA |
| FA283                              | FA283HH | - | -   | -   |

# FA291 43.8 x 56.8 x 6.45mm

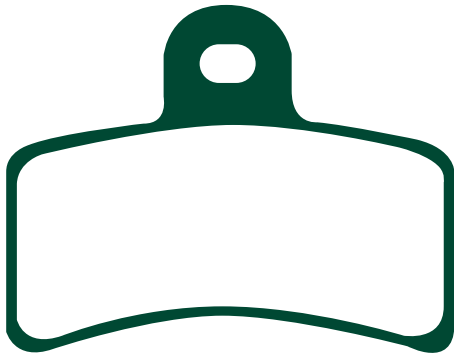

## FANTIC

Trial 50

06 F&R

## GAS GAS

Cross MC 50

06 F

125/200/249/270/280/321 TXT

99-03 F&R

50/80 TXT

01-02 F&R

50 EC Rookie

01-02 R

50 EC Boy

01 F&R

TXT Boy 50/280

01 F&R

EC Boy 50

01 F&R

EC 50 (Boy)

01-04 F&R

EC 50 (Rookie)

01-04 R

EC 50

05 R

TXT 50 (Boy)

01 F&R

TXT 50/80 (Rookie)

02-03 F&R

SM 50 (Rookie)

01-04 R

SM 50

05 R

Pampera 125/250/280

04 R

Pampera 250

02 R

SM 50 Rookie

01-02 R

TXT Rookie 50/80 Trail

06-07 F

TXT 200/270/321

99 F&R

TXT 125/200/249/280/321

00-03 F&R

Pampera 250

02-03 R

## BETA

RR Enduro Alu/Motard Alu

03- R

### Competitor X Ref

| Dunlop | Ferodo  | SBS | Vesrah |
|--------|---------|-----|--------|
| DP640  | FDB2103 | 815 | -      |

### Equivalents OE #

BT-27922065  
BT-280022065

| MATERIAL AVAILABILITY AND PART NO. |         |   |     |     |
|------------------------------------|---------|---|-----|-----|
| STD                                | OPTIONS |   |     |     |
| FA                                 | HH      | R | MXS | GFA |
| FA291                              | -       | - | -   | -   |

**FA293S = Green**  
**FA293 = Blue**

**A. 22Ø x 5.95mm (Plain pin)**  
**B. 22Ø x 5.95mm (Thread pin)**

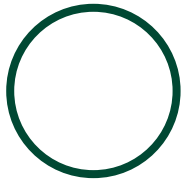

**MINI MOTO**  
Pasini/Polini/GRC  
**HRD**  
SX 50 Mini Cross

F&R

**Equivalents OE #**

143 750 009

| MATERIAL AVAILABILITY AND PART NO. |         |   |     |     |
|------------------------------------|---------|---|-----|-----|
| STD                                | OPTIONS |   |     |     |
| FA                                 | HH      | R | MXS | GFA |
| FA293                              | -       | - | -   | -   |
| FA293S (Green)                     | -       | - | -   | -   |

**Competitor X Ref**

| Dunlop | Ferodo | SBS | Vesrah |
|--------|--------|-----|--------|
| -      | -      | -   | -      |

**FA294HH 81 x 45.9 x 7.7mm**

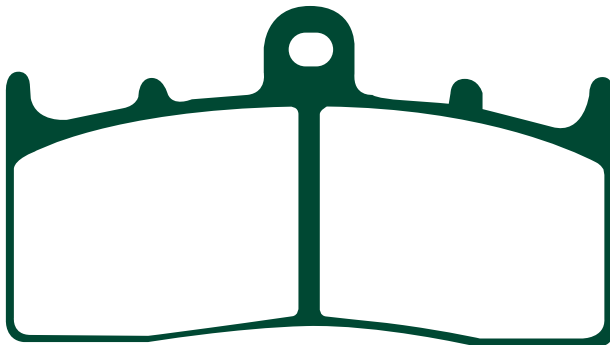

**BMW**

|                                   |          |   |
|-----------------------------------|----------|---|
| R 850 R                           | 04-06    | F |
| R 1100 S (with integral ABS)      | 12/00-06 | F |
| R 1150 R/RS                       | 01-06    | F |
| R 1150 R Rockster                 | 03-06    | F |
| R 1150 Rockster Edition 80        | 04       | F |
| R 1150 GS Adventure               | 03-06    | F |
| K 1200 LT                         | 11/00-07 | F |
| K 1200 R                          | 05-07    | F |
| R 1200 CL                         | 03-04    | F |
| R 1200 C Independent (Cast wheel) | 03-04    | F |
| R 1200 C Montauk                  | 04       | F |
| R 1200 C Classic                  | 03-04    | F |
| R 1200 R Sport                    | 06-07    | F |
| K 1200 R Sport                    | 07       | F |

**KAWASAKI**

|                        |       |   |
|------------------------|-------|---|
| ZRX 400 (ZR 400 E4-E7) | 98-01 | F |
|------------------------|-------|---|

**Equivalents OE #**

34 11 7 658 386  
34 11 7 655 898  
43082 1217

**Competitor X Ref**

| Dunlop | Ferodo  | SBS     | Vesrah |
|--------|---------|---------|--------|
| DP639  | FDB2124 | 743/778 | VD439  |

**MATERIAL AVAILABILITY AND PART NO.**

| STD | OPTIONS |   |     |     |
|-----|---------|---|-----|-----|
| FA  | HH      | R | MXS | GFA |
| -   | FA294HH | - | -   | -   |

**GFA295HH 77.6 x 44 x 10.4mm**

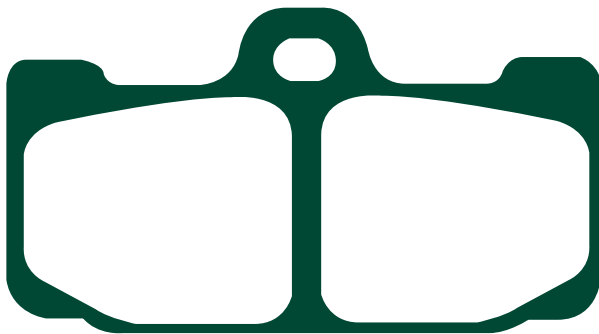

**Race use only**

**BREMBO**

P4 32/36 X 97.37.80/81

**Equivalents OE #**

**Competitor X Ref**

| Dunlop | Ferodo | SBS | Vesrah |
|--------|--------|-----|--------|
| -      | -      | 741 | VD9021 |

**MATERIAL AVAILABILITY AND PART NO.**

| STD | OPTIONS |   |     |          |
|-----|---------|---|-----|----------|
| FA  | HH      | R | MXS | GFA      |
| -   | -       | - | -   | GFA295HH |

# FA296HH 74.75 x 55.4 x 7.6mm (No shim fitted)

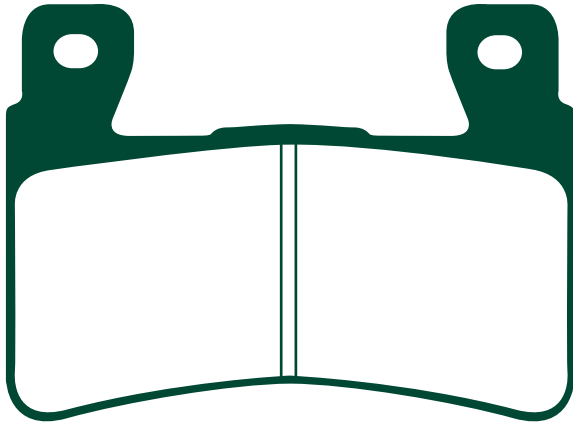

## HONDA

|  |       |   |
|--|-------|---|
| CB 400 SFX/SFY/SF1/SF2/SF3 Super Four  | 99-03 | F |
| CB 400 SBS                             | 05    | F |
| CB 400 SF4/5/S5                        | 04-05 | F |
| CBR 600 FX/FY                          | 99-00 | F |
| CBR 600 F1/F2/ CBR 600 FS1/FS2 'Sport' | 01-02 | F |
| CBR 600 F3/F4/F5/F6/F7                 | 03-07 | F |
| CBR 600 RR3/RR4                        | 03-04 | F |
| CB 1300 F3/F13                         | 03-04 | F |
| CB 1300 5/6 (Superfour)                | 05-06 | F |
| CB 1300 A5/A6 (Superfour ABS)          | 05-06 | F |
| CB 1300 S5                             | 05    | F |
| CB 1300 SA5/SA6 Super Bol-Dor          | 05-06 | F |

### Equivalents OE #

|               |
|---------------|
| 06455 MBW 006 |
| 06455 MBW E11 |

### Competitor X Ref

| Dunlop | Ferodo  | SBS | Vesrah |
|--------|---------|-----|--------|
| DP127  | FDB2079 | 734 | VD166  |

### MATERIAL AVAILABILITY AND PART NO.

| STD | OPTIONS |   |     |          |
|-----|---------|---|-----|----------|
| FA  | HH      | R | MXS | GFA      |
| -   | FA296HH | - | -   | GFA296HH |

# FA297 A. 105 x 43.6 x 7.84mm B. 66 x 36.5 x 12.7mm

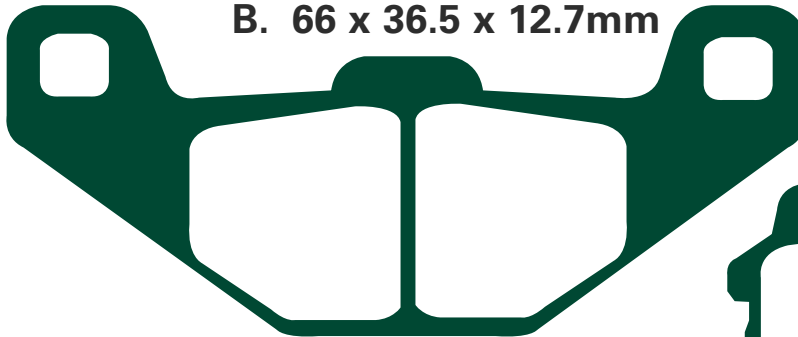

## SYM

|                |       |   |
|----------------|-------|---|
| Huskey 125/150 | 99-05 | F |
| CT 125         | 03-04 | F |



### Equivalents OE #

|                 |
|-----------------|
| 45105 N02 001 A |
|-----------------|

### Competitor X Ref

| Dunlop | Ferodo  | SBS | Vesrah |
|--------|---------|-----|--------|
| -      | FDB2129 | 745 | VD9019 |

### MATERIAL AVAILABILITY AND PART NO.

| STD   | OPTIONS |   |     |     |
|-------|---------|---|-----|-----|
| FA    | HH      | R | MXS | GFA |
| FA297 | -       | - | -   | -   |

# FA298 50.96 x 53.40 x 9.5mm



## APRILIA

|                                   |       |   |
|-----------------------------------|-------|---|
| SR 50 (All models with rear disc) | 00-07 | R |
| Scarabeo 50 (Di-Tech)             | 01-04 | R |
| Atlantic 125/200/250              | 03-06 | R |
| RS 125 (Radial Caliper model)     | 06-07 | R |
| Leonardo 250 ST/SP                | 00-04 | R |
| Scarabeo 125/150/200              | 99-02 | R |
| Scarabeo 125/200                  | 03    | R |
| Scarabeo 125/150/250 GT           | 04-06 | R |
| Scarabeo 125/200                  | 07    | R |
| Scarabeo 250                      | 06    | R |
| Scarabeo 250 ie                   | 07    | R |
| Leonardo 300                      | 05-06 | R |
| Sport City 125/200                | 04-07 | R |
| Sport City 250 ie                 | 07    | R |
| Atlantic 400 Sprint               | 07    | R |
| Scarabeo 400 ie                   | 07    | R |
| Atlantic 500                      | 02-04 | R |
| Atlantic 500 Sprint               | 05-07 | R |
| Scarabeo 500                      | 03-06 | R |

|                            |       |   |
|----------------------------|-------|---|
| Scarabeo 500 ie            | 07    | R |
| Scarabeo 500 Light         | 07    | R |
| <b>BENELLI</b>             |       |   |
| Velvet 250                 | 99-07 | R |
| Velvet 400                 | 03-04 | R |
| <b>BETA</b>                |       |   |
| Eikon 125/150              | 00-06 | R |
| <b>DERBI</b>               |       |   |
| Boulevard S125             | 07    | R |
| <b>MALAGUTI</b>            |       |   |
| Madison T125/150/R180/S250 | 99-03 | R |
| F18 Warrior 125/150        | 00-03 | R |
| Phantom Max 125/200        | 04-07 | R |
| Phantom Max 250            | 04-07 | R |
| Spider Max GT 500          | 04-07 | R |
| R 125 Madison              | 03-07 | R |
| Madison S 200              | 04    | R |
| 250 Madison                | 04-07 | R |
| Madison K 400              | 02-06 | R |
| Password 250               | 05-07 | R |

### Equivalents OE #

|             |          |         |
|-------------|----------|---------|
| 811 3869    | 11948600 | 8213577 |
| 119 491 00  | 8213506  | 8133726 |
| 2525371000  | 8133539  | 8133946 |
| R44440161A0 | 8133946  |         |

### Competitor X Ref

| Dunlop | Ferodo  | SBS | Vesrah |
|--------|---------|-----|--------|
| -      | FDB2090 | 747 | -      |

### MATERIAL AVAILABILITY AND PART NO.

| STD   | OPTIONS |   |     |     |
|-------|---------|---|-----|-----|
| FA    | HH      | R | MXS | GFA |
| FA298 | -       | - | -   | -   |

# FA299

A. 92.9 x 65.15 x 7.5mm  
B. 92.9 x 65.15 x 7.5mm



**Replaced by  
FA400**

**Competitor X Ref**

| Dunlop | Ferodo  | SBS | Vesrah |
|--------|---------|-----|--------|
| DP918  | FDB2097 | 750 | VD971  |

**Will be replaced by FA400  
when stocks exhausted**

| MATERIAL AVAILABILITY AND PART NO. |         |   |     |     |
|------------------------------------|---------|---|-----|-----|
| STD                                | OPTIONS |   |     |     |
| FA                                 | HH      | R | MXS | GFA |
| FA299                              | FA299HH | - | -   | -   |

**Equivalents OE #**

|          |
|----------|
| 44082-00 |
|----------|

**HARLEY DAVIDSON**

New 4 piston caliper 2000-2004 models F&R  
Check page 39/40 for application details.

**IMPORTANT NOTE:**

This pad fits 04 and prior models only.  
See also FA400 which has similar  
shape but larger friction area.  
**DO NOT ATTEMPT TO FIT THIS PAD IN  
MODELS AFTER 05.**  
Always compare old pad shape.



**If you still have stock  
of FA299/299HH refer to  
note opposite**

# FA301

53.90 x 50.75 x 8.00mm

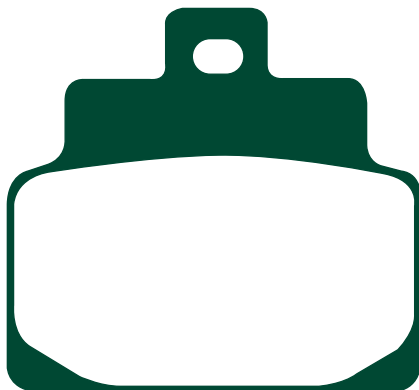

**APRILIA**

|                          |       |   |
|--------------------------|-------|---|
| Scarabeo 100             | 00-02 | F |
| Habana 125               | 00-02 | F |
| Leonardo 125/150 ST/SP   | 99-04 | F |
| Leonardo 125             | 05-06 | F |
| SR 125/150               | 99-02 | F |
| Mojito/Mojito Custom 125 | 03-07 | F |

**Equivalents OE #**

|         |
|---------|
| 8213460 |
| 8213462 |

**Competitor X Ref**

| Dunlop | Ferodo  | SBS | Vesrah |
|--------|---------|-----|--------|
| -      | FDB2095 | 748 | -      |

| MATERIAL AVAILABILITY AND PART NO. |         |   |     |     |
|------------------------------------|---------|---|-----|-----|
| STD                                | OPTIONS |   |     |     |
| FA                                 | HH      | R | MXS | GFA |
| FA301                              | -       | - | -   | -   |



**FA302** A. 67.65 x 36.52 x 7.58mm  
B. 51.90 x 40.10 x 7.62mm

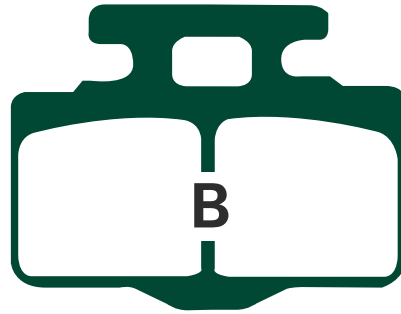
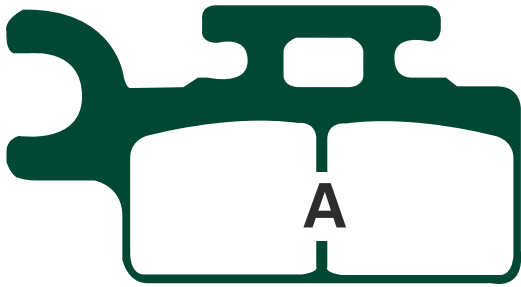

**KAWASAKI**

KX 65 A1/A2/A3/A4/A5/A6/A6F/A7F 00-07 F

**SUZUKI**

RM 65 K3/K4/K5 03-05 F

**Competitor X Ref**

|                        |                          |                   |                        |
|------------------------|--------------------------|-------------------|------------------------|
| <b>Dunlop</b><br>DP328 | <b>Ferodo</b><br>FDB2110 | <b>SBS</b><br>752 | <b>Vesrah</b><br>VD440 |
|------------------------|--------------------------|-------------------|------------------------|

**Equivalents OE #**

|            |             |
|------------|-------------|
| 43082-1242 | K4308-21242 |
| 43082-0042 |             |

**MATERIAL AVAILABILITY AND PART NO.**

| STD     | OPTIONS |        |     |     |
|---------|---------|--------|-----|-----|
| FA      | HH      | R      | MXS | GFA |
| FA302TT | -       | FA302R | -   | -   |

**FA303** 49.95 x 43.85 x 5.9mm



**AJP**

PR4-Enduro 125/200 04-07 R  
PR4-Supermotard 125/200 04-07 R

**BETA**

Rev 3 125/200 00-06 F&R  
Rev3 125/200 06 F  
Rev 3 250/270 00-04 F&R  
Rev 3 250/270 05-07 F  
RR Enduro Alu 03- F

**GAS-GAS**

TXT 125/200/250/280/300 (TXT PRO) 04-07 F  
EC 50 Boy (LC) 05 F  
TXT 80 Rookie 04-05 F

**SHERCO**

1.25 06-07 F  
2.5/2.9 01-07 F  
3.2 (320 4T) 05-07 F  
Trials 0.8 06-07 F

**HONDA/MONTESA**

315R 01-04 F  
250 4RT Cota 05-07 F

**SCORPA**

SY 125 F Trials 03-05 F  
SY 175 F 06 F  
SY 250 F 06-07 F  
SY 250 Long Ride 04-07 F  
SY 250 00-07 F

**Equivalents OE #**

|               |            |              |
|---------------|------------|--------------|
| 45105 NN3 830 | 2525352000 | 00TRS01A0027 |
| 6211          | C389       |              |

**Competitor X Ref**

|                    |                          |                   |                    |
|--------------------|--------------------------|-------------------|--------------------|
| <b>Dunlop</b><br>- | <b>Ferodo</b><br>FDB2109 | <b>SBS</b><br>802 | <b>Vesrah</b><br>- |
|--------------------|--------------------------|-------------------|--------------------|

**MATERIAL AVAILABILITY AND PART NO.**

| STD   | OPTIONS |   |     |     |
|-------|---------|---|-----|-----|
| FA    | HH      | R | MXS | GFA |
| FA303 | -       | - | -   | -   |

**FA304** 75.05 x 54.90 x 8.97mm



**BMW**

R 1200 CL 03-04 R  
K 1200 LT (All models) 97-07 R

**Equivalents OE #**

|                 |
|-----------------|
| 34 2 17 671 246 |
| 34 2 17 657 492 |
| 34 2 12 333 337 |

**Competitor X Ref**

|                        |                          |                   |                    |
|------------------------|--------------------------|-------------------|--------------------|
| <b>Dunlop</b><br>DP637 | <b>Ferodo</b><br>FDB2102 | <b>SBS</b><br>746 | <b>Vesrah</b><br>- |
|------------------------|--------------------------|-------------------|--------------------|

**MATERIAL AVAILABILITY AND PART NO.**

| STD   | OPTIONS |   |     |     |
|-------|---------|---|-----|-----|
| FA    | HH      | R | MXS | GFA |
| FA304 | FA304HH | - | -   | -   |

# FA305

A 84.95 x 43.5 x 8.60mm  
B 63.95 x 36 x 10.96mm

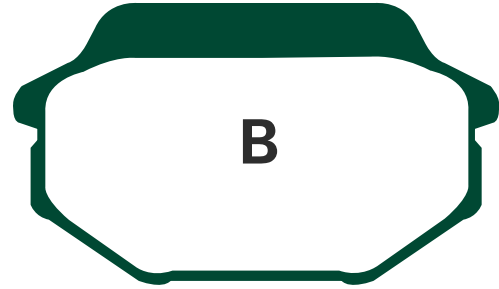

**Equivalents OE #**

|                 |            |
|-----------------|------------|
| 8900539         | 43082 Y001 |
| 45105 KFA6 3050 |            |

**LAVERDA**

|                          |       |   |
|--------------------------|-------|---|
| Phoenix 125/150/200      | 01-04 | R |
| <b>KYMCO</b>             |       |   |
| People 50/125/150        | 99-06 | F |
| People S 50/125/200      | 05-07 | F |
| Super 9 50 (LC)          | 01-07 | R |
| Mxer 50 (Quad)           | 00-07 | R |
| Mxer 150 Quad            | 02-07 | R |
| MXU 50/150               | 05-06 | R |
| Maxxer 90                | 05-06 | R |
| People S125/200 (BA40BA) | 05-06 | F |

**SYM**

|                     |       |   |
|---------------------|-------|---|
| HD 125/200          | 04-07 | F |
| Joyride 125/150/200 | 01-07 | R |
| SK 125              | 03-04 | R |
| GT 500              | 04    | R |

**Competitor X Ref**

| Dunlop | Ferodo  | SBS | Vesrah |
|--------|---------|-----|--------|
| -      | FDB2096 | 749 | -      |

**MATERIAL AVAILABILITY AND PART NO.**

| STD   | OPTIONS |        |     |     |
|-------|---------|--------|-----|-----|
| FA    | HH      | R      | MXS | GFA |
| FA305 | -       | FA305R | -   | -   |

# FA306

70.13 x 41.85 x 8.07mm

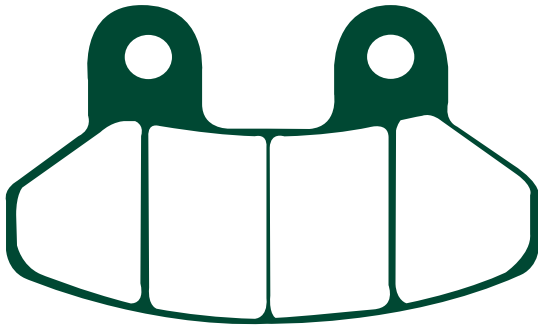

**LAVERDA**

|                     |       |   |
|---------------------|-------|---|
| Phoenix 125/150/200 | 01-04 | F |
|---------------------|-------|---|

**SYM**

|                     |       |   |
|---------------------|-------|---|
| RS 50               | 04-07 | F |
| Shark 50            | 99-03 | F |
| RS 125              | 04-06 | F |
| Euro MX 125/150     | 02-06 | F |
| SK 125              | 03-04 | F |
| Shark 125/150       | 99-02 | F |
| Shark 4VR 125       | 01-02 | F |
| Joyride 125/150/200 | 01-07 | F |
| VS 125/150          | 06-07 | F |
| RS 150              | 06    | F |
| Euro MX125          | 06    | F |

**Equivalents OE #**

|                |
|----------------|
| 45105 HA3A 000 |
| 8900239        |

**Competitor X Ref**

| Dunlop | Ferodo  | SBS | Vesrah |
|--------|---------|-----|--------|
| -      | FDB2108 | 749 | -      |

**MATERIAL AVAILABILITY AND PART NO.**

| STD   | OPTIONS |   |     |     |
|-------|---------|---|-----|-----|
| FA    | HH      | R | MXS | GFA |
| FA306 | -       | - | -   | -   |

# FA307 A 82.08 x 40.85 x 9.46mm

# B 62.03 x 40.80 x 9.46mm

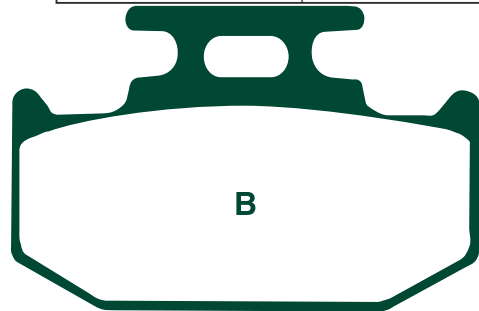
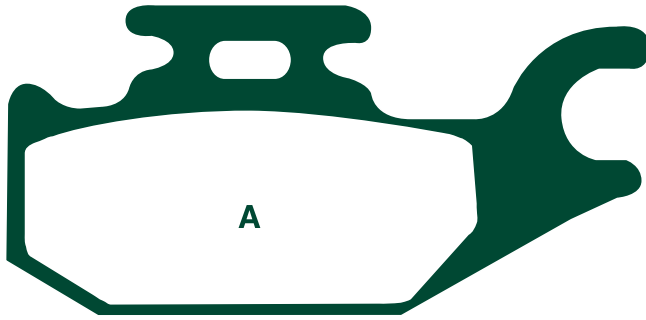

### Equivalents OE #

|              |             |
|--------------|-------------|
| 5GH W0046 00 | 705 600 398 |
| 705 600 014  | 705 600 349 |
| ID9 W0046 00 |             |

### YAMAHA

|                               |       |   |
|-------------------------------|-------|---|
| YFM 400 FAM/FAN               | 00-01 | R |
| YFM 400 FWT (Big Bear)        | 05    | R |
| YFM 400 FGW Grizzly           | 07    | R |
| YFM 450 FAR/FAS               | 03-04 | R |
| YFM 450 FAT/FAHT/FAV (Kodiak) | 05-06 | R |
| YFM 450 FXV Wolverine         | 06    | R |
| YFM 450 FGW Grizzly           | 07    | R |

### BOMBARDIER

|                                     |       |           |
|-------------------------------------|-------|-----------|
| Most models (see application pages) | 01-06 | F(left)&R |
|-------------------------------------|-------|-----------|

### CAN-AM

|  |    |           |
|--|----|-----------|
| Rally 200 (4A7A/B/C/D/E/F)                       | 07 | R         |
| Outlander 400 (4x4 STD) (2D7A/B/C/D/E/F/G/H)     | 07 | F(left)&R |
| Outlander 400 (XT 4x4) (2E7A/B/C/D/E/F)          | 07 | F(left)&R |
| Outlander Max 400 (STD 4x4) (2F7B/C/D/E/F/G/H/J) | 07 | F(left)&R |
| Outlander Max 400 (XT 4x4) (2G7A/B/C/D/E)        | 07 | F(left)&R |

|   |    |           |
|---|----|-----------|
| Outlander 500 (STD 4x4) (2T7A/B/C/D) (2W7A/B/C)                         | 07 | F(left)&R |
| Outlander 500 (XT 4x4) (2O7A/B/C/D)                                     | 07 | F(left)&R |
| Outlander Max 500 (XT 4x4) (2X7A/B/C)                                   | 07 | F(left)&R |
| DS 650 X (3B7A/B)   | 07 | F(left)&R |
| Outlander 650 (4x4 STD) (2N7A/B/C/D/E/F/G/H)                            | 07 | F(left)&R |
| Outlander 650 (XT 4x4) (2P7A/B/C/D/E/F)                                 | 07 | F(left)&R |
| Outlander Max 650 (STD 4x4) (2R7A/B/C/D/E/F/G/H/J/K)                    | 07 | F(left)&R |
| Outlander Max 650 (XT 4x4) (2S7A/B/C/D/E/F)                             | 07 | F(left)&R |
| Outlander 800 (STD 4x4) (2H7A/B/C/D/E/F/G/H)                            | 07 | F(left)&R |
| Outlander Max 800 (Ltd 4x4) (2M7A/B/C) (STD 4x4) (2K7A/B/C/D/E/F/G/H/J) | 07 | F(left)&R |
| Outlander (XT 4x4) (2J7A/B/C/D/E/F)                                     | 07 | F(left)&R |

### CANNONDALE

|   |       |           |
|---|-------|-----------|
| All quads (check main application pages for fitments) | 01-04 | F(left)&R |
|---|-------|-----------|

### JOHN DEERE ATV

|                                     |       |           |
|-------------------------------------|-------|-----------|
| Most models (see application pages) | 04-05 | F(left)&R |
|-------------------------------------|-------|-----------|

### Competitor X Ref

| Dunlop | Ferodo  | SBS | Vesrah |
|--------|---------|-----|--------|
| DP327  | FDB2148 | 754 | VD266  |

### MATERIAL AVAILABILITY AND PART NO.

| STD<br>FA | OPTIONS |        |     |     |
|-----------|---------|--------|-----|-----|
|           | HH      | R      | MXS | GFA |
| FA307TT   | -       | FA307R | -   | -   |

# FA313R 123.5 x 55 x 9.25mm

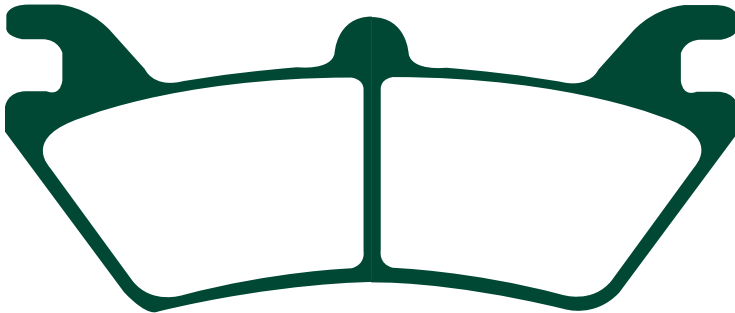

### POLARIS

|                       |       |   |
|-----------------------|-------|---|
| Sportsman 6x6         | 00-03 | R |
| PTV (6x6)             | 03    | R |
| PPS/PTV 6x6/Series 10 |       | R |
| PPS LUH 6x6           | 02    | R |

### Equivalents OE #

|         |
|---------|
| 2201685 |
| 2201749 |

### Competitor X Ref

| Dunlop | Ferodo  | SBS | Vesrah |
|--------|---------|-----|--------|
| -      | FDB2177 | 757 | -      |

### MATERIAL AVAILABILITY AND PART NO.

| STD<br>FA | OPTIONS |        |     |     |
|-----------|---------|--------|-----|-----|
|           | HH      | R      | MXS | GFA |
| -         | -       | FA313R | -   | -   |

# FA314R 90.3 x 41.05 x 8.2mm



### Equivalents OE #

|         |
|---------|
| 2201871 |
| 2202414 |
| 1911129 |

### POLARIS

|                          |       |   |
|--------------------------|-------|---|
| Magnum 325/500           | 02-03 | R |
| Xpedition 325            | 02    | R |
| Magnum 330 (2x4/HDS)     | 03-04 | R |
| Magnum 330 (4x4/HDS)     | 03-04 | R |
| Sportsman 400            | 03    | R |
| Sportsman 400            | 03-04 | R |
| ATV Pro 500 4x4 TPS      | 02    | R |
| Magnum 500 HDS           | 02-03 | R |
| Magnum 500 (2x4/4x4 HDS) | 02    | R |
| Sportsman 500 HP         | 03-04 | R |
| Sportsman 600 4x4        | 03-04 | R |
| Sportsman 700 (4x4)      | 02-04 | R |
| Sportsman MV 700         | 05    | R |
| Sportsman 800            | 05    | R |
| PPS/PTV 4x4/Series 10    |       | R |
| Sportsman 500 X2         | 06    | R |

### Competitor X Ref

| Dunlop | Ferodo  | SBS | Vesrah |
|--------|---------|-----|--------|
| DP932  | FDB2176 | 787 | -      |

### MATERIAL AVAILABILITY AND PART NO.

| STD<br>FA | OPTIONS |        |     |     |
|-----------|---------|--------|-----|-----|
|           | HH      | R      | MXS | GFA |
| -         | -       | FA314R | -   | -   |

# FA317 A 82.08 x 40.85 x 9.46mm

# B 62.03 x 40.80 x 9.46mm

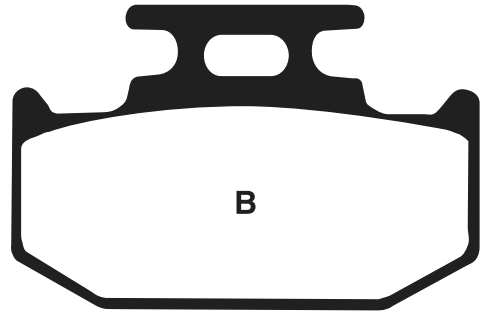
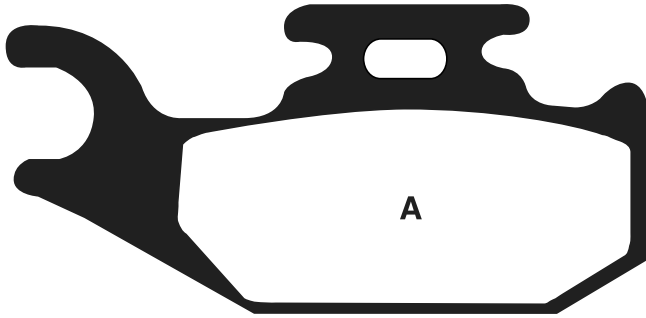

**SUZUKI**

LT-A 500 FK2 Vision 4WD 02 R

**BOMBARDIER**

Most models (see application pages) 01-06 F(right)&R

**CAN-AM**

- Outlander 400 (4x4 STD) (2D7A/B/C/D/E/F/G/H) 07 F(right)
- Outlander 400 (XT 4x4) (2E7A/B/C/D/E/F) 07 F(right)
- Outlander Max 400 (STD 4x4) (2F7B/C/D/E/F/G/H/J) 07 F(right)
- Outlander Max 400 (XT 4x4) (2G7A/B/C/D/E) 07 F(right)
- Outlander 500 (STD 4x4) (2T7A/B/C/D) 07 F(right)
- Outlander 500 (XT 4x4) (2U7A/B/C/D) 07 F(right)
- Outlander Max 500 (STD 4x4) (2W7A/B/C) 07 F(right)
- Outlander Max 500 (XT 4x4) (2X7A/B/C) 07 F(right)
- DS 650 X (3B7A/B) 07 F(right)
- Outlander 650 (4x4 STD) (2N7A/B/C/D/E/F/G/H) 07 F(right)
- Outlander 650 (XT 4x4) (2P7A/B/C/D/E/F) 07 F(right)
- Outlander Max 650 (STD 4x4) (2R7A/B/C/D/E/F/G/H/J/K) 07 F(right)
- Outlander Max 650 (XT 4x4) (2S7A/B/C/D/E/F) 07 F(right)
- Outlander 800 (STD 4x4) (2H7A/B/C/D/E/F/G/H) 07 F(right)
- Outlander 800 (XT 4x4) (2J7A/B/C/D/E/F) 07 F(right)
- Outlander Max 800 (Ltd 4x4) (2M7A/B/C) 07 F(right)
- Outlander Max 800 (STD 4x4) (2K7A/B/C/D/E/F/G/H/J) 07 F(right)
- Outlander Max 800 (XT 4x4) (2L7A/B/C/D/E/F) 07 F(right)

**CANNONDALE**

All quads (check main application pages for fitments) 01-04 F(Right)

**JOHN DEERE ATV**

Most models (see application pages) 01-05 F(right)&R

**Equivalents OE #**

|             |              |
|-------------|--------------|
| 705 600 004 | 5UG W0045 00 |
| 69100 03840 | 705 600 350  |
| 705 600 150 | 1S3 W0046 00 |

**Competitor X Ref**

| Dunlop | Ferodo  | SBS | Vesrah |
|--------|---------|-----|--------|
| DP920  | FDB2149 | 767 | -      |

**MATERIAL AVAILABILITY AND PART NO.**

| STD     | OPTIONS |        |     |     |
|---------|---------|--------|-----|-----|
| FA      | HH      | R      | MXS | GFA |
| FA317TT | -       | FA317R | -   | -   |

# FA319 99.95 x 36.25 x 11.95mm

# FA319/2 99.95 x 36.25 x 9.5mm



**Equivalents OE # FA319**

5GJ W0045 00

**Equivalents OE # FA319/2**

|              |              |
|--------------|--------------|
| 5JW W0046 00 | 3P6 W0046 50 |
| 5PS W0046 00 | 1D7 W0046 00 |

**FA319 - YAMAHA**

XP 500 N/P/R T-Max 01-03 R

**FA319/2 - YAMAHA**

TDM 900 P/R/S/T/V 02-06 R

TDM 900 AT/AV/AW (ABS) 05-07 R

FJR 1300 N/P/R/AR/S/AS/AT (ABS) 01-05 R

FJR 1300 AV/ASV (3P61/2/3) (ABS) 06-07 R

FJR 1300 AS (2D21) 06-07 R

XVS 1300 A Midnight Star 07 R

XV 1700 PCR 03-05 R

XV 1900 A Mldnight Star 06-07 R

**HYOSUNG**

GV 650 04-05 R

**SYM**

Voyager 250 05 R

**Competitor X Ref FA319**

| Dunlop | Ferodo | SBS | Vesrah |
|--------|--------|-----|--------|
| DP423  | FB2126 | 768 | VD269  |

**MATERIAL AVAILABILITY AND PART NO.**

| STD   | OPTIONS |   |     |     |
|-------|---------|---|-----|-----|
| FA    | HH      | R | MXS | GFA |
| FA319 | FA319HH | - | -   | -   |

**Competitor X Ref FA319/2**

| Dunlop | Ferodo | SBS | Vesrah  |
|--------|--------|-----|---------|
| DP423  | FB2156 | 769 | VD269/2 |

**MATERIAL AVAILABILITY AND PART NO.**

| STD     | OPTIONS   |   |     |     |
|---------|-----------|---|-----|-----|
| FA      | HH        | R | MXS | GFA |
| FA319/2 | FA319/2HH | - | -   | -   |

# FA320HH 69.75 x 42.6 x 7.45mm

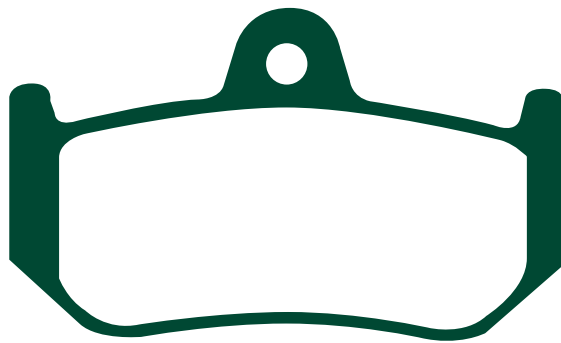

## M.V. AGUSTA

|                                   |       |   |
|-----------------------------------|-------|---|
| F4 750                            | 99-03 | R |
| Brutale 750 S                     | 03-06 | R |
| F4 1000                           | 04-06 | R |
| F4 1000 R                         | 07    | R |
| F4 1000 R1&1                      | 07    | R |
| F4 1000 CC                        | 07    | R |
| F4 1000 (Brembo 4 piston caliper) | 06    | R |
| Brutale 910 S                     | 05-06 | R |
| Brutale 910 R                     | 05-07 | R |
| Brutale 910 Standard              | 05-07 | R |
| Brutale 910 R Italia              | 07    | R |
| F4 1000 Senna                     | 06    | R |

### Equivalents OE #

8000 82748

### Competitor X Ref

| <u>Dunlop</u> | <u>Ferodo</u> | <u>SBS</u> | <u>Vesrah</u> |
|---------------|---------------|------------|---------------|
| DP958         | FDB2198       | 763        | -             |

### MATERIAL AVAILABILITY AND PART NO.

| <u>STD</u> | <u>OPTIONS</u> |          |            |            |
|------------|----------------|----------|------------|------------|
| <u>FA</u>  | <u>HH</u>      | <u>R</u> | <u>MXS</u> | <u>GFA</u> |
| -          | FA320HH        | -        | -          | -          |

# FA321 55.5 x 49 x 7.5mm

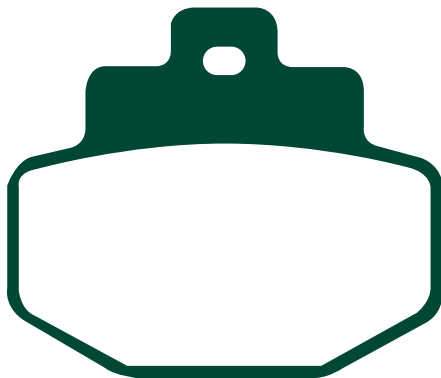

## BENELLI

Adiva 125/150 01-04 R

## GILERA

125 VX 4T/180/VXR 200 4T 01-05 R

DNA 125/180 01-03 R

VX 125 Runner (4T) 05-07 R

VXR 200 Runner (4T) 02-07 R

## PIAGGIO/VESPA

Super Hexagon GTX 125/180 12" wheels 01-03 R

Super Hexagon GTX 250 00-02 R

GT 125 L Granturismo 03-06 R

GTV 125 07 R

GT 200 L Granturismo 03-06 R

GTS 250 iE/ABS 05-07 R

GT 60 (Special Anniversary Model) (GTV 250) 06 R

GTV 250 ie 07 R

### Equivalents OE #

|        |             |
|--------|-------------|
| 497002 | R44440181A0 |
| 497348 | 647161      |

### Competitor X Ref

| <u>Dunlop</u> | <u>Ferodo</u> | <u>SBS</u> | <u>Vesrah</u> |
|---------------|---------------|------------|---------------|
| DP327         | -             | 772        | -             |

### MATERIAL AVAILABILITY AND PART NO.

| <u>STD</u> | <u>OPTIONS</u> |          |            |            |
|------------|----------------|----------|------------|------------|
| <u>FA</u>  | <u>HH</u>      | <u>R</u> | <u>MXS</u> | <u>GFA</u> |
| FA321      | -              | -        | -          | -          |

# FA322/4HH 35 x 40.53mm x 7.4mm

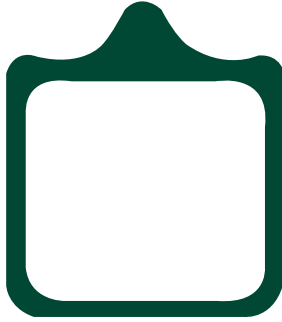

**NOTE:- Pads are sold as 4pcs - i.e. one caliper set**

**APRILIA**

RSV Mille/Mille R (inc radial mount calipers) 01-07 F  
 1000 Tuono (Factory) 02-07 F  
 Tornado LE/Tornado TRE Novecento/RS 03-05 F  
 TNT 1130 Cafe Racer 06-07 F

**BENELLI**

TNT 1130 Sport/Sport Evo 04-07 F  
 TNT 1130 Titanium 06 F  
 Tornado Tre 1130 06 F  
 2-UE (750cc) 07 F

**BIMOTA**

Elirio 06 F  
 DB5 (All models) 06-07 F  
 DB5R 06-07 F  
 DB6 Delirio (992cc Ducati engine) 07 F  
 SB8K Santamonica (996cc Suzuki engine) 07 F

**BREMBO**

20 7850 11/21 (P434A) 4 piston wire clip pad retention  
 20 8343 35/45 11/21 (P4 34B) Radial goldline  
 mount wire clip pad retention

**CAGIVA**

Raptor X3 1000 03-04 F

**DERBI**

Mulhacen 659 06-07 F  
 Mulhacen 650 Hot Bob 07 F  
 Mulhacen 659 Cafe 07 F  
 Mulhacen 659 X Vision 07 F

**DUCATI**

748 R 01-02 F  
 748 RS 01 F  
 749/749 S/749 R 03-06 F  
 749 Dark 04-06 F  
 998 S 02 F  
 998 R 02 F  
 999/999 S/999 R 03-06 F  
 S4RS (998cc) 06 F  
 S4R (998cc) Testasretta 07 F  
 999 R (Xerox) 06 F

**HUSQVARNA**

SMR 450 RR Radial caliper 06-07 F  
 SM 450 R Radial caliper 07 F  
 SM 510 R (Radial caliper) 06-07 F  
 SM 610 S (Radial caliper) 06 F  
 SM 610 ie 07 F  
 STR 650 CRC 07 F

**KTM**

690 SM Prestige 07 F  
 SM 950 Supermoto 05-06 F  
 990 Superduke 05-07 F  
 990 Superduke R 07 F

**LAVERDA**

SFC 1000 03-04 F

**MONDIAL**

Piega 1000 03-04 F  
 EVO 04 F

**MOTO GUZZI**

MGS 01 03 F  
 MGS-01 Corsa 07 F  
 Griso 04 F  
 Fionda 1100 05 F

**M.V. AGUSTA**

F4 100 Senna 06 F  
 Brutale 910 R 05-07 F  
 Brutale 910 R Italia 07 F  
 F4 1000 (Brembo 4 piston calipers) 06 F  
 F4 1000 R 07 F  
 F4 1000 R1&1 07 F

**PETRONAS**

FP1 05 F

**TM**

SMX 450 F 05-07 F  
 SMX 530 F 05-07 F  
 SMX 660 F 05-07 F

**VOXAN**

Charade Racing 06 F

**Equivalents OE #**

|                 |                |           |
|-----------------|----------------|-----------|
| 613 403 01A     | 610 13 030 000 | 862697    |
| 613 40391 A     | 8000A2040      | 8000A7417 |
| 8223972         | 69177          |           |
| R 180 100 12600 | 862486         |           |

**Competitor X Ref**

| Dunlop | Ferodo  | SBS | Vesrah |
|--------|---------|-----|--------|
| DP638  | FDB2120 | 762 | VD986  |

**MATERIAL AVAILABILITY AND PART NO.**

| STD | OPTIONS   |   |     |            |
|-----|-----------|---|-----|------------|
| FA  | HH        | R | MXS | GFA        |
| -   | FA322/4HH | - | -   | GFA322/4HH |

# FA323 81 x 42 x 9.3mm

# FA323/2 81 x 42 x 6.9mm

# FA323/3 81 x 42 x 8.2mm

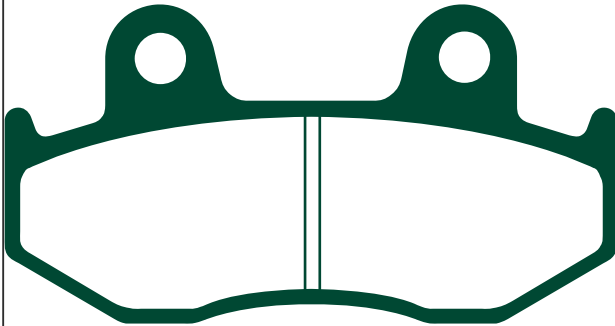

**Competitor X Ref FA323**

| Dunlop | Ferodo  | SBS | Vesrah |
|--------|---------|-----|--------|
| -      | FDB2119 | -   | -      |

**Competitor X Ref FA323/2**

| Dunlop | Ferodo  | SBS | Vesrah |
|--------|---------|-----|--------|
| -      | FDB2119 | -   | -      |

**Competitor X Ref FA323/3**

| Dunlop | Ferodo  | SBS | Vesrah |
|--------|---------|-----|--------|
| -      | FDB2119 | 781 | -      |

## FA323

### HONDA

|                                     |       |   |
|-------------------------------------|-------|---|
| NES 125 Y/1/2/3/4/5 (@ 125 Scooter) | 00-05 | F |
| PS 125 i 6/7                        | 06-07 | F |
| SH 125 1/3/4/5/6i                   | 01-07 | F |
| NES 150 Y/1/2/3/4/5 " @150 Scooter" | 01-05 | F |
| SH 150 1/3/4/5/6i/7i                | 01-07 | F |
| SES 125/150 2/3/4 Dylan             | 02-07 | F |

### ITALJET

|              |    |     |
|--------------|----|-----|
| Torpedo 125  | 07 | F   |
| Jack 125/150 | 07 | F&R |

### MZ

|               |       |   |
|---------------|-------|---|
| Mantizz 125 S | 05-07 | F |
|---------------|-------|---|

### YAMAHA

|             |       |   |
|-------------|-------|---|
| YFZ 450 V/W | 06-07 | R |
|-------------|-------|---|

## FA323/2

### HONDA

|                    |       |   |
|--------------------|-------|---|
| CH 250 F/G "Spacy" | 85-86 | F |
|--------------------|-------|---|

## FA323/3

### SUZUKI

|                        |       |   |
|------------------------|-------|---|
| AN 250 W/X/Y 'Burgman' | 98-00 | R |
| AN 400 X/Y 'Burgman'   | 99-00 | R |

### KAWASAKI

|                         |       |   |
|-------------------------|-------|---|
| SC 250 A1 (Epsilon 250) | 02-03 | R |
|-------------------------|-------|---|

**MATERIAL AVAILABILITY AND PART NO.**

| STD   | OPTIONS |        |     |     |
|-------|---------|--------|-----|-----|
| FA    | HH      | R      | MXS | GFA |
| FA323 | -       | FA323R | -   | -   |

**MATERIAL AVAILABILITY AND PART NO.**

| STD     | OPTIONS |   |     |     |
|---------|---------|---|-----|-----|
| FA      | HH      | R | MXS | GFA |
| FA323/2 | -       | - | -   | -   |

**MATERIAL AVAILABILITY AND PART NO.**

| STD     | OPTIONS |   |     |     |
|---------|---------|---|-----|-----|
| FA      | HH      | R | MXS | GFA |
| FA323/3 | -       | - | -   | -   |

Equivalents OE # - FA323    06455 GCS 006    5TG W0046 10

Equivalents OE # - FA323/3

|             |
|-------------|
| 69100 14840 |
| 69100 14860 |
| 43082 S003  |

Equivalents OE # - FA323/2

|               |               |
|---------------|---------------|
| 45105 KM1 004 | 45105 KM1 712 |
| 45105 KM1 007 | 45105 KM1 710 |
| 45105 KM1 711 |               |

# FA324 117.5 x 41.3 x 8.6mm



**Equivalents OE #**

|            |         |
|------------|---------|
| 119 481 00 | 8133761 |
| 81133603   |         |

**Competitor X Ref**

| Dunlop | Ferodo  | SBS | Vesrah |
|--------|---------|-----|--------|
| -      | FDB2105 | 761 | VD9017 |

## APRILIA

|                         |       |   |
|-------------------------|-------|---|
| Atlantic 125/200/250    | 03-07 | F |
| Atlantic 400 Sprint     | 07    | F |
| Atlantic 500 Sprint     | 05-07 | F |
| Scarabeo 125/150/250 GT | 04-06 | F |
| Scarabeo 125/200        | 07    | F |
| Scarabeo 250 ie         | 07    | F |

## MALAGUTI

|               |       |   |
|---------------|-------|---|
| Madison S 250 | 99-03 | F |
| Madison K 400 | 02-06 | F |

## PEUGEOT

|                |       |   |
|----------------|-------|---|
| LOOXOR 125/150 | 03-06 | F |
|----------------|-------|---|

**MATERIAL AVAILABILITY AND PART NO.**

| STD   | OPTIONS |   |     |     |
|-------|---------|---|-----|-----|
| FA    | HH      | R | MXS | GFA |
| FA324 |         |   |     |     |

# FA325R 43.45 x 25.2 x 5mm



**Equivalents OE #**

451 13 030 000

## HUSQVARNA

|                          |       |     |
|--------------------------|-------|-----|
| CR 50 Senior Pro         | 05    | R   |
| <b>LEM</b>               |       |     |
| R2/R3 (Hydraulic System) | 03-05 | F&R |
| <b>KTM</b>               |       |     |
| CR 50 Senior Pro         | 05    | R   |
| 50 SX Pro Senior LC      | 02-03 | F   |
| 50 SX Senior Adventure   | 02-07 | F   |
| 50 SX Pro Senior LC      | 04-07 | F&R |
| 50 Supermoto             | 06    | F&R |
| 65 SX                    | 04-07 | R   |
| <b>TOMOS</b>             |       |     |
| MC 50 Senior             | 05    | F&R |

**Competitor X Ref**

| MATERIAL AVAILABILITY AND PART NO. |         |        |     |     |
|------------------------------------|---------|--------|-----|-----|
| STD                                | OPTIONS |        |     |     |
| FA                                 | HH      | R      | MXS | GFA |
| FA325TT                            | -       | FA325R | -   | -   |

| Dunlop | Ferodo  | SBS | Vesrah |
|--------|---------|-----|--------|
| DP923  | FDB2183 | 794 | -      |

# FA335HH 77.2 x 51.45 x 8.55mm

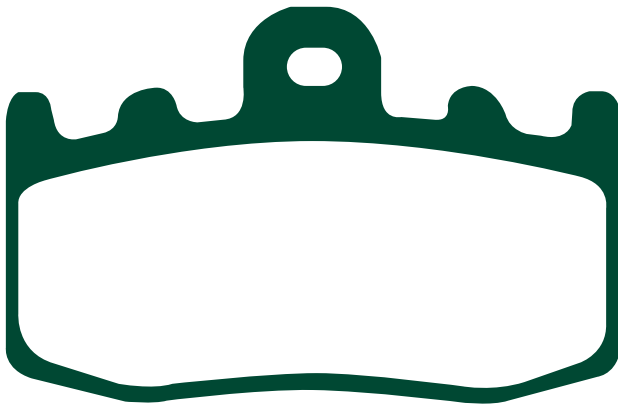

## BMW

|                                   |          |         |
|-----------------------------------|----------|---------|
| R 850 RT                          | 06       | F       |
| R 1100 S (Non ABS)                | 12/00-03 | F       |
| R 1150 GS                         | 12/01-04 | F       |
| R 1150 RT (Integral ABS)          | 00-04    | F       |
| R 1200 GS                         | 04-07    | F       |
| K 1200 RS/R/S                     | 01-05    | F       |
| K 1200 GT (K41)                   | 03-06    | F       |
| K 1200 GT (K44)                   | 06-07    | F(left) |
| K 1200 S (K40)                    | 05-07    | F       |
| R 1200 RT (K26)                   | 03-07    | F       |
| R 1200 ST (K28)                   | 03-07    | F       |
| R 1200 S                          | 06-07    | F       |
| HP2 Megamoto                      | 07       | F       |
| R 1200 GS Adventure (Spoke wheel) | 07       | F       |

**Equivalents OE #**

34 11 7 660 448  
34 11 7 671 780

**Competitor X Ref**

| MATERIAL AVAILABILITY AND PART NO. |         |   |     |     |
|------------------------------------|---------|---|-----|-----|
| STD                                | OPTIONS |   |     |     |
| FA                                 | HH      | R | MXS | GFA |
| -                                  | FA335HH | - | -   | -   |

| Dunlop | Ferodo  | SBS | Vesrah |
|--------|---------|-----|--------|
| DP641  | FDB2125 | 796 | -      |

# FA336 77.85 x 46.5 x 7.05mm

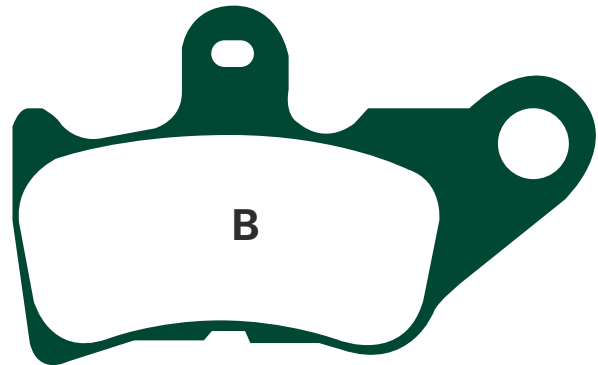
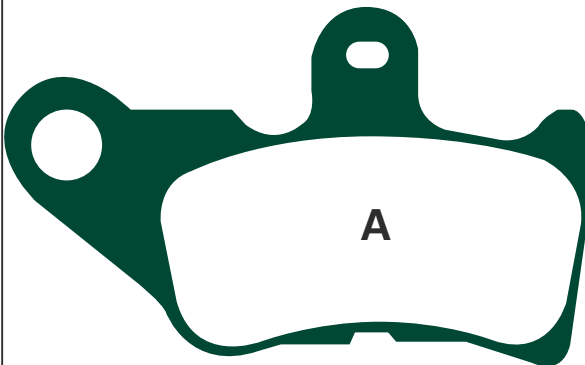

## YAMAHA

|                               |       |   |
|-------------------------------|-------|---|
| CV 50 ZR (5PT1) Evolution     | 01-02 | F |
| CV 50 (5KN1/2) Jog-Cool Style | 00-02 | F |
| MI0 (113cc)                   | 05-07 | F |
| MI0 Sporty (113cc)            | 05-07 | F |
| Nuovo-Z (113cc)               | 06-07 | F |

**Equivalents OE #**

5KN W0045 00

**Competitor X Ref**

| MATERIAL AVAILABILITY AND PART NO. |         |   |     |     |
|------------------------------------|---------|---|-----|-----|
| STD                                | OPTIONS |   |     |     |
| FA                                 | HH      | R | MXS | GFA |
| FA336                              | -       | - | -   | -   |

| Dunlop | Ferodo | SBS | Vesrah |
|--------|--------|-----|--------|
| -      | 764    | 764 | VD267  |



# FA337 35.2 x 51.5 x 6mm

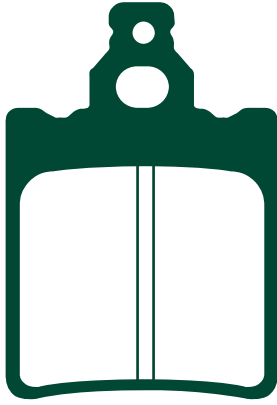

## APRILIA

280 R Climber

92-93 R

## BETA

M4 350 Supermotard

04-06 R

## JCM

240 Europa

89- R

## KTM

60 SX

00 R

65 SX

00-03 R

### Equivalents OE #

460 13 090 000

### Competitor X Ref

| MATERIAL AVAILABILITY AND PART NO. |         |        |     |     |
|------------------------------------|---------|--------|-----|-----|
| STD                                | OPTIONS |        |     |     |
| FA                                 | HH      | R      | MXS | GFA |
| FA337TT                            | -       | FA337R | -   | -   |

| Dunlop | Ferodo | SBS | Vesrah |
|--------|--------|-----|--------|
| -      | -      | -   | -      |

# FA342R A. 26.1 x 119.55 x 7.1mm

B. 35.6 x 94.54 x 7.8mm

### Equivalents OE #

43082 1255

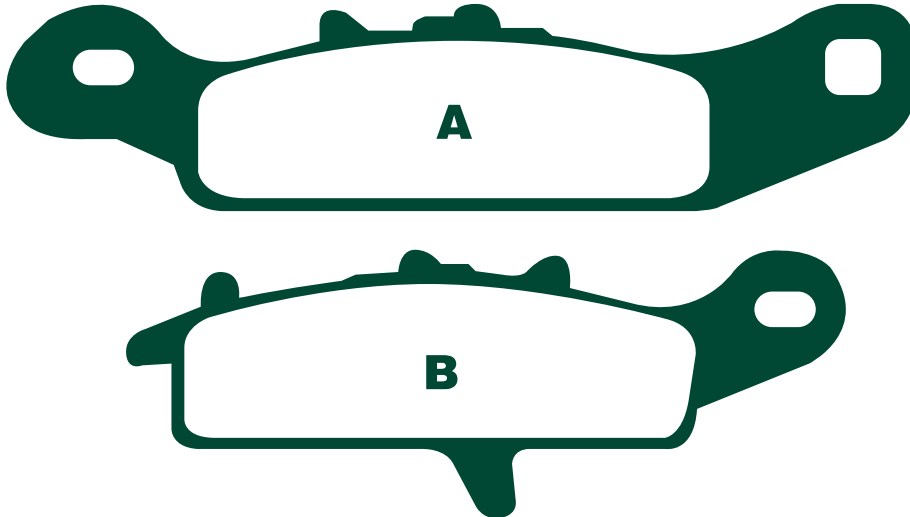

## KAWASAKI

KFX 450 R Quad

07

F(Left)

KVF 650 A1/A2 Prairie

02-03

F(Left)

KVF 650 D1/D6F Brute Force 4x4

05-06

F(Left)

KVF 650 E1/E6F Brute Force 4x4

Hardwoods Green HD

05-06

F(Left)

KSV 700 A1/B1/A2/A6F/B2/B6F (KFX 700)

04-06

F(Left)

KVF 700 A1/B1/A2/A6F/B2/B6F 4x4 (Prairie)

04-06

F(Left)

KVF 700 D1 Team Green

05

F(Left)

## SUZUKI

LT-V 700 FK4/FK5 Twin Peaks

04-05

F(Left)

### Competitor X Ref

| MATERIAL AVAILABILITY AND PART NO. |         |        |     |     |
|------------------------------------|---------|--------|-----|-----|
| STD                                | OPTIONS |        |     |     |
| FA                                 | HH      | R      | MXS | GFA |
| -                                  | -       | FA342R | -   | -   |

| Dunlop | Ferodo  | SBS | Vesrah |
|--------|---------|-----|--------|
| DP929  | FDB2188 | 801 | VD441  |

# FA343 A. 107 x 41 x 10mm B. 91.6 x 40.6 x 10mm

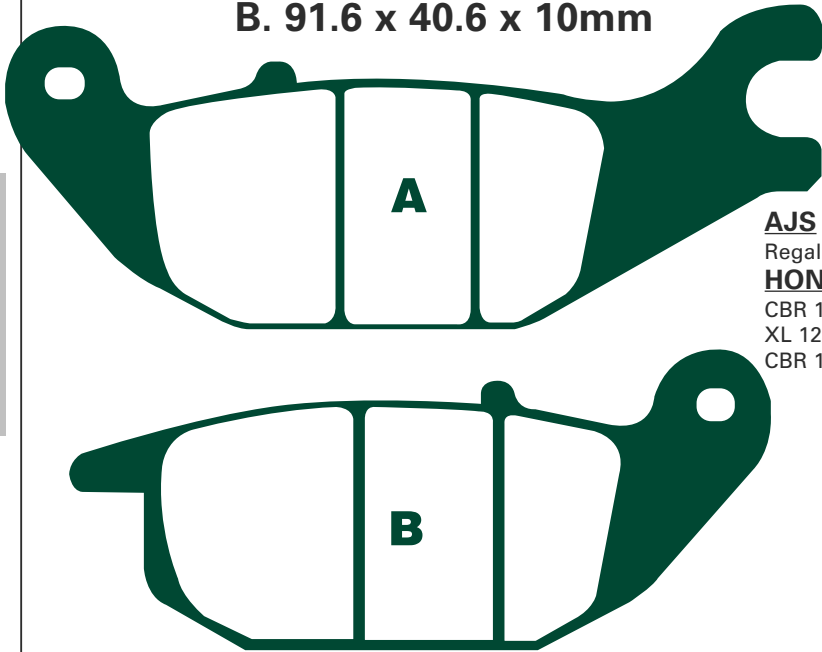

|              |                                      |       |   |
|--------------|--------------------------------------|-------|---|
| <b>AJS</b>   | Regal Raptor CR3-125                 | 06    | R |
| <b>HONDA</b> | CBR 125 RR4/RR5/RS5/RW5/RR6/R7       | 04-07 | R |
|              | XL 125 V1/V2/V3/V4/V5/V6/V7 Varadero | 01-07 | R |
|              | CBR 150 R                            | 00-03 | R |

**Equivalents OE #**

|               |
|---------------|
| 06435 KPC 641 |
| 06435 KPP 901 |

**Competitor X Ref**

| MATERIAL AVAILABILITY AND PART NO. |         |   |     |     |
|------------------------------------|---------|---|-----|-----|
| STD                                | OPTIONS |   |     |     |
| FA                                 | HH      | R | MXS | GFA |
| FA343                              | -       | - | -   | -   |

| Dunlop | Ferodo  | SBS | Vesrah |
|--------|---------|-----|--------|
| DP129  | FDB2143 | 784 | -      |

# FA344 65.5 x 44.75 x 11.65mm

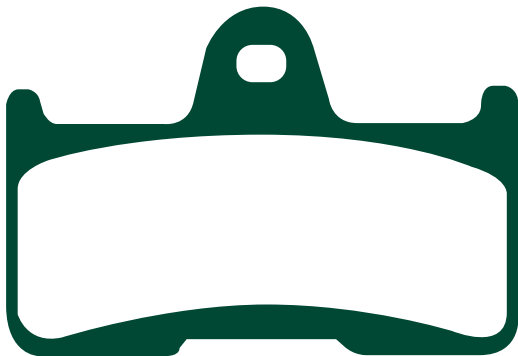

|               |  |       |   |
|---------------|--|-------|---|
| <b>YAMAHA</b> | YFM 660 FWAP/FWAR/FWAS/FWAT/FWAW/FGW Grizzly | 02-07 | R |
|               | YFM 660 FR/FS/FT Grizzly                     | 03-05 | R |

**Equivalents OE #**

|              |
|--------------|
| 5KM W0046 00 |
|--------------|

**Competitor X Ref**

| Dunlop | Ferodo  | SBS | Vesrah |
|--------|---------|-----|--------|
| DP930  | FDB2193 | 799 | VD270  |

| MATERIAL AVAILABILITY AND PART NO. |         |        |     |     |
|------------------------------------|---------|--------|-----|-----|
| STD                                | OPTIONS |        |     |     |
| FA                                 | HH      | R      | MXS | GFA |
| FA344TT                            | -       | FA344R | -   | -   |

# FA345HH 91.7 x 49.3 x 8.1mm



**NOTE:  
REFIT ORIGINAL HEAT SHIM  
TO NEW EBC PADS**

|              |                 |       |   |
|--------------|-----------------|-------|---|
| <b>BUELL</b> | XB9R            | 02-07 | F |
|              | XB9S            | 03-07 | F |
|              | XB9SX           | 05-07 | F |
|              | XB 12 S         | 04-07 | F |
|              | XB 12 R         | 04-07 | F |
|              | XB 12 SS        | 06-07 | F |
|              | XB 12 SCG       | 06-07 | F |
|              | XB 12 X Ulysses | 06-07 | F |

**Equivalents OE #**

|            |
|------------|
| H0300-02A8 |
|------------|

**Competitor X Ref**

| MATERIAL AVAILABILITY AND PART NO. |         |   |     |          |
|------------------------------------|---------|---|-----|----------|
| STD                                | OPTIONS |   |     |          |
| FA                                 | HH      | R | MXS | GFA      |
| -                                  | FA345HH | - | -   | GFA345HH |

| Dunlop | Ferodo  | SBS | Vesrah |
|--------|---------|-----|--------|
| DP926  | FDB2145 | 795 | -      |

# FA346 60 x 44.8 x 11mm

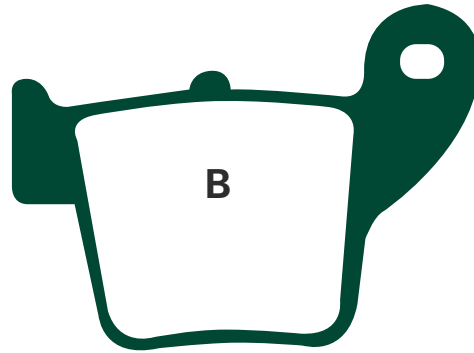
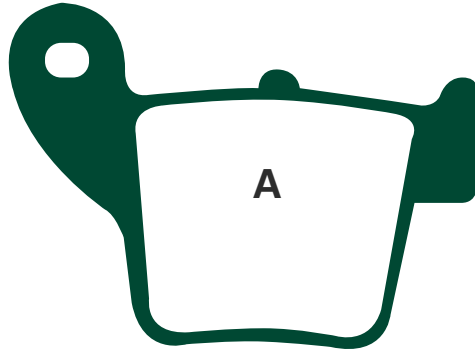

### HONDA

|                        |       |   |
|------------------------|-------|---|
| CR 125 R2/R3/R4/R5/R6  | 02-06 | R |
| CRF 150 RB7/R7         | 07    | R |
| CR 250 R2/R3/R4/R5/R6  | 02-06 | R |
| CRF 250 R4/R5/R6       | 04-06 | R |
| CRF 250 X4/X5/X6       | 04-06 | R |
| CRF 450 R2/R3/R4/R5/R6 | 02-06 | R |
| CRF 450 X5/X6          | 05-06 | R |

### HONDA-DALL'ARA

|               |    |   |
|---------------|----|---|
| XR 250 SM     | 04 | R |
| XR 400/440 R  | 04 | R |
| XR 400/440 SM | 04 | R |

### HONDA-HM (ITALY)

|                         |       |   |
|-------------------------|-------|---|
| CRE 125 R Supermotard   | 02-03 | R |
| CRE 125 R Enduro        | 04-06 | R |
| CR 125 Motard           | 04    | R |
| CRE 125 R Enduro        | 02-03 | R |
| CRM 125 R Supermoto     | 07    | R |
| CR 150 R/R2             | 07    | R |
| CR 230 Easy Trail       | 04    | R |
| CRF 230 Easy Enduro     | 04    | R |
| CRF 230 Easy Motard     | 04    | R |
| CRE 250                 | 02    | R |
| CRE 250 R Supermotard   | 02-03 | R |
| CRE 250 R Enduro        | 02-06 | R |
| CRE 250 X               |       | R |
| CRM 250 X Supermoto     | 07    | R |
| CR 250 R Moto           | 04    | R |
| CRE 250 F Enduro        | 04    | R |
| CRF 250 Motard          | 04    | R |
| CRE F 290 X             | 07    | R |
| CRE 450 F Enduro        | 02-06 | R |
| CRE 450 F               | 02    | R |
| CRF 450 Motard          | 04    | R |
| CRE 450 F Supermoto     | 02-03 | R |
| CRE 450 X               |       | R |
| CRM F 450 R/X Supermoto | 07    | R |
| CRE F 490 X             | 07    | R |
| CRM F 490 X Supermoto   | 07    | R |

### Equivalents OE #

|               |               |
|---------------|---------------|
| 06435 KZ4 J41 | 06434 KRN 711 |
|---------------|---------------|

### Competitor X Ref

| MATERIAL AVAILABILITY AND PART NO. |         |        |        |          |
|------------------------------------|---------|--------|--------|----------|
| STD                                | OPTIONS |        |        |          |
| FA                                 | HH      | R      | MXS    | GFA      |
| FA346TT                            | -       | FA346R | MXS346 | GFA346HH |

| Dunlop | Ferodo  | SBS | Vesrah |
|--------|---------|-----|--------|
| DP921  | FDB2139 | 777 | VD168  |

# FA347HH 69.5 x 49.55 x 7mm

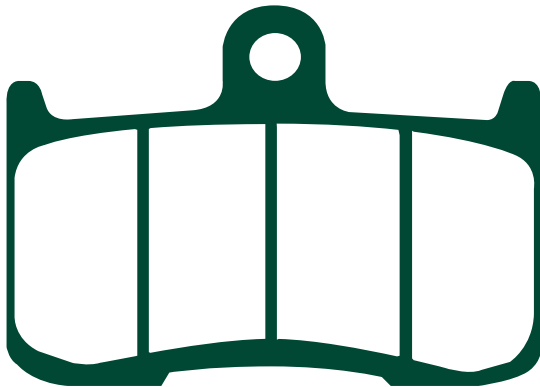

### KAWASAKI

|                           |       |   |
|---------------------------|-------|---|
| ZX9R (ZX 900 F1/F2)       | 02-04 | F |
| Z 1000 (ZR 1000 A1/A2/A3) | 03-05 | F |

### TRIUMPH

|                               |       |   |
|-------------------------------|-------|---|
| Speed Triple (Radial caliper) | 06-07 | F |
| Daytona 675                   | 06    | F |
| Tiger 1050 (radial caliper)   | 07    | F |

### YAMAHA

|                         |       |   |
|-------------------------|-------|---|
| TZ 250 (Radial Caliper) | 03-05 | F |
|-------------------------|-------|---|

### Equivalents OE #

|              |            |
|--------------|------------|
| 43082 1290   | T 2020 329 |
| 43082 0002   | T 2020 475 |
| 5XE W0045 00 |            |

### Competitor X Ref

| MATERIAL AVAILABILITY AND PART NO. |         |   |     |          |
|------------------------------------|---------|---|-----|----------|
| STD                                | OPTIONS |   |     |          |
| FA                                 | HH      | R | MXS | GFA      |
| -                                  | FA347HH | - | -   | GFA347HH |

| Dunlop | Ferodo  | SBS | Vesrah |
|--------|---------|-----|--------|
| DP922  | FDB2158 | 782 | VD443  |

# FA348 63.35 x 60.32 x 8.9mm



## YAMAHA

|  |       |   |
|--|-------|---|
| FZS 1000 Fazer   | 01-05 | R |
| XJR 1300 N/P /5EAP/5EAR/5EAS/5EAT/5EAW<br>/5EAV/5EAY) (298mm front disc) | 01-02 | R |
| XJR 1300 R/S 5WM1/5WM3/5WM5<br>/5WM6/5WM7/5WM9                           | 03-04 | R |
| XJR 1300 T/V/W 5WMA/5WMC<br>/5WMD/5WMF                                   | 05-07 | R |

### Equivalents OE #

5LV W0046 50

### Competitor X Ref

| Dunlop | Ferodo  | SBS | Vesrah |
|--------|---------|-----|--------|
| -      | FDB2150 | 770 | VD268  |

| MATERIAL AVAILABILITY AND PART NO. |         |   |     |     |
|------------------------------------|---------|---|-----|-----|
| STD                                | OPTIONS |   |     |     |
| FA                                 | HH      | R | MXS | GFA |
| FA348                              | FA348HH | - | -   | -   |

# FA349R A. 26.1 x 119.55 x 7.1mm

B. 35.6 x 94.54 x 7.8mm

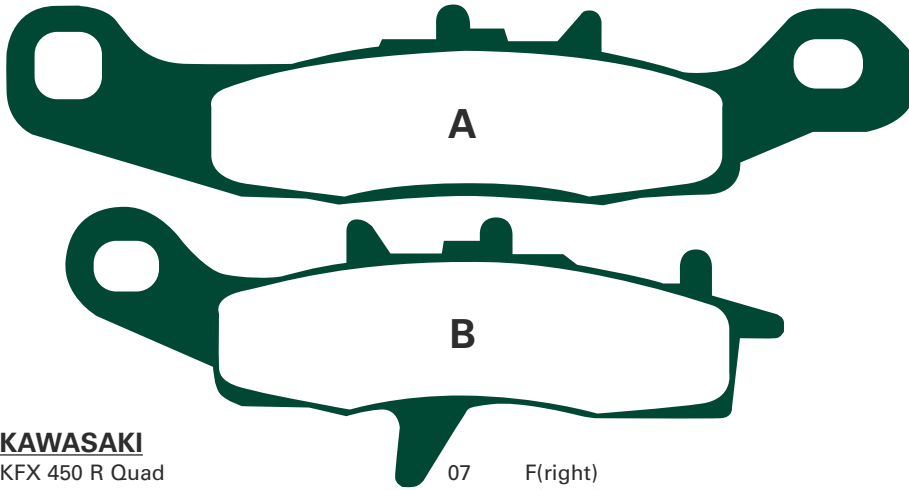

### Equivalents OE #

43082 1273

## KAWASAKI

|  |       |          |
|--|-------|----------|
| KFX 450 R Quad                                       | 07    | F(right) |
| KVF 650 A1/A2 Prairie                                | 02-03 | F(right) |
| KVF 650 D1/D6F Brute Force 4x4                       | 05-06 | F(right) |
| KVF 650 E1/E6F Brute Force 4x4<br>Hardwoods Green HD | 05-06 | F(right) |
| KSV 700 A1/A2/A6F/B2/B6F (KFX 700)                   | 04-06 | F(right) |
| KVF 700 A1/B1/A2/A6F/B2/B6F 4x4 (Prairie)            | 04-06 | F(right) |
| KVF 700 D1 Team Green                                | 05    | F(right) |

## SUZUKI

|                             |       |          |
|-----------------------------|-------|----------|
| LT-V 700 FK4/FK5 Twin Peaks | 04-05 | F(right) |
|-----------------------------|-------|----------|

### Competitor X Ref

| Dunlop | Ferodo | SBS | Vesrah |
|--------|--------|-----|--------|
| -      | -      | 798 | VD442  |

| MATERIAL AVAILABILITY AND PART NO. |         |        |     |     |
|------------------------------------|---------|--------|-----|-----|
| STD                                | OPTIONS |        |     |     |
| FA                                 | HH      | R      | MXS | GFA |
| -                                  | -       | FA349R | -   | -   |

# FA350 50.1 x 47.4 x 6.8mm

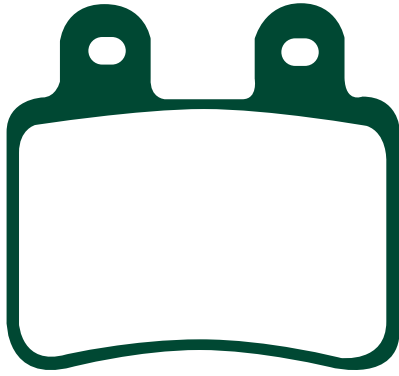

## DERBI

|                       |       |     |
|-----------------------|-------|-----|
| Rambla 50             | 06    | F&R |
| Rambla 125            | 06    | F&R |
| Boulevard 125/150/200 | 03-07 | F   |
| Terra 125             | 07    | F   |
| Freexter 125          | 07    | R   |

## HONDA HM (Italy)

|                          |       |   |
|--------------------------|-------|---|
| CRE 50 Baja/Six/Derapage | 03-06 | R |
|--------------------------|-------|---|

## PEUGEOT

|  |       |   |
|--|-------|---|
| Elyseo 125/150   | 01-03 | R |
| Elystar 125/150 (All models)                             | 02-07 | R |
| Elystar 50 TSDi Advantage                                | 02-07 | R |
| Jet Force 125 (All models)                               | 03-07 | R |
| Satelis 125 4V Executive/Premium/City (4 stroke/4 valve) | 06-07 | R |
| Satelis 125 Compressor 4 stroke all models               | 06-07 | R |
| Geopolis 250 (AJP Caliper)                               | 06-07 | R |
| Satelis 250 (AJP Calipers)                               | 07    | R |

## ITALJET

|                       |       |   |
|-----------------------|-------|---|
| Jet Set 50/125/150    | 02-03 | F |
| Millenium 100/125/150 | 02-04 | F |

## MBK

|                   |       |     |
|-------------------|-------|-----|
| X-Limit Enduro    | 03-06 | F&R |
| X-Limit Supermoto | 03-06 | R   |

## YAMAHA

|          |       |     |
|----------|-------|-----|
| DT 50 R  | 02-07 | F&R |
| DT 50 X  | 04-07 | R   |
| XT 125 R | 05-07 | F&R |
| XT 125 X | 05-07 | R   |

### Equivalents OE #

|         |              |             |
|---------|--------------|-------------|
| 745658  | 00G01202221  | 00H01304931 |
| 4722090 | 3D6 F5811 00 | K01303070   |
| 755981  | 1D4 F5742 00 | 7588626     |

### Competitor X Ref

| Dunlop | Ferodo  | SBS | Vesrah |
|--------|---------|-----|--------|
| -      | FDB2128 | 773 | -      |

| MATERIAL AVAILABILITY AND PART NO. |         |   |     |     |
|------------------------------------|---------|---|-----|-----|
| STD                                | OPTIONS |   |     |     |
| FA                                 | HH      | R | MXS | GFA |
| FA350                              | -       | - | -   | -   |

# FA351 36 x 39 x 6mm

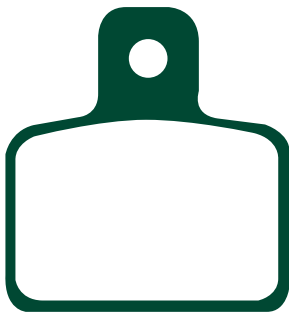

## APRILIA

|                       |    |   |
|-----------------------|----|---|
| Mini RX 50 Experience | 04 | F |
|-----------------------|----|---|

## BETA

|                          |       |     |
|--------------------------|-------|-----|
| Minicross Pro Race 12/10 | 04-06 | F&R |
| Pro Race 50              | 05    | R   |

## FACTORY

|                  |    |   |
|------------------|----|---|
| Phantom R14 Agua | 04 | F |
|------------------|----|---|

## GAS-GAS

|                                   |       |     |
|-----------------------------------|-------|-----|
| Cross MC 50                       | 06    | R   |
| Cross MC 65                       | 06    | F&R |
| TXT Cadet 80                      | 06    | F&R |
| TXT Rookie 50/80 Trail            | 06-07 | R   |
| TXT 125/200/250/280/300 (TXT PRO) | 04-07 | R   |
| EC 50 Boy (Air cooled)            | 05    | R   |
| EC 50 Boy (LC)                    | 05-07 | R   |
| MC 65                             | 05    | F   |
| TXT 80 Rookie                     | 04-05 | R   |

## HONDA HM (Italy)

|                    |       |     |
|--------------------|-------|-----|
| Baja 10/10 JR & SR | 99-07 | F&R |
| Baja 12/14 MX      | 99-07 | F&R |

## HUSQVARNA

|                  |    |   |
|------------------|----|---|
| CR 50 Senior Pro | 05 | F |
| CR 50 Junior     | 05 | F |
| TE 100           | 05 | F |

## SHERCO

|                     |       |   |
|---------------------|-------|---|
| All models 0.8      | 01-05 | R |
| 1.25                | 06-07 | R |
| All models 2.5/2.90 | 01-06 | R |
| 3.2 (320 4T)        | 05    | R |
| Trials 0.8          | 06    | R |
| 2.5i Enduro (4T)    | 06    | R |

## MONTESA/HONDA

|              |       |   |
|--------------|-------|---|
| Honda 315 R  | 01-04 | R |
| 250 4RT Cota | 05-07 | R |

## SCORPA

|                  |       |   |
|------------------|-------|---|
| SY 125 F Trials  | 03-06 | R |
| SY 250           | 00-07 | R |
| SY 250 Long Ride | 04-07 | R |
| TYS 125 F        | 06-07 | R |
| SY 175 F         | 06    | R |
| TY-S 175 F       | 06    | R |
| SY 250 F         | 06-07 | R |
| Roadster 660     | 07    | R |

## TOMOS

|                  |       |     |
|------------------|-------|-----|
| MC 50 Senior Pro | 05-07 | F&R |
|------------------|-------|-----|

### Equivalents OE #

|               |             |
|---------------|-------------|
| 43105 NN3 820 | BT280222068 |
| 7040          | KM0961320   |
| C390          |             |

### Competitor X Ref

| Dunlop | Ferodo  | SBS | Vesrah |
|--------|---------|-----|--------|
| -      | FDB2127 | 803 | -      |

| MATERIAL AVAILABILITY AND PART NO. |         |   |     |     |
|------------------------------------|---------|---|-----|-----|
| STD                                | OPTIONS |   |     |     |
| FA                                 | HH      | R | MXS | GFA |
| FA351                              | -       | - | -   | -   |

# FA352 37.55 x 31.3 x 5.55mm

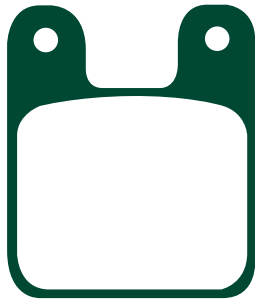

## MINI MOTO

Polini/Pasini/GRC Calipers (Square 2 pin type) F & R

### Equivalents OE #

144 750 008

| MATERIAL AVAILABILITY AND PART NO. |         |   |     |     |
|------------------------------------|---------|---|-----|-----|
| STD                                | OPTIONS |   |     |     |
| FA                                 | HH      | R | MXS | GFA |
| FA352                              | -       | - | -   | -   |

### Competitor X Ref

| Dunlop | Ferodo | SBS | Vesrah |
|--------|--------|-----|--------|
| DP951  | -      | -   | -      |

# FA353 A. 96.8 x 39.35 x 9.3mm B. 77 x 42 x 9.3mm

**NOTE: HENG TONG CALIPER**

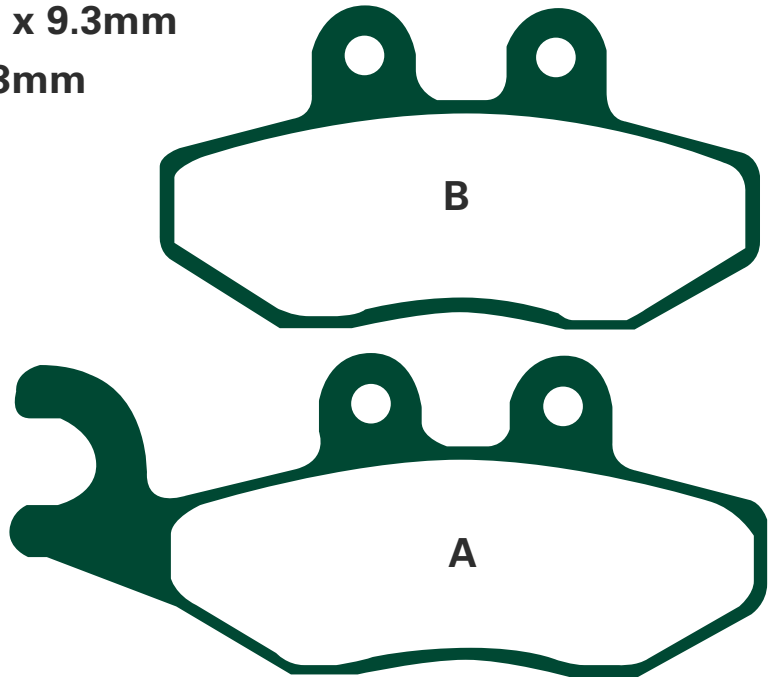

### Equivalents OE #

|        |
|--------|
| 497072 |
| 497116 |
| 647078 |

### Competitor X Ref

| Dunlop | Ferodo | SBS | Vesrah |
|--------|--------|-----|--------|
| -      | -      | -   | -      |

| MATERIAL AVAILABILITY AND PART NO. |         |   |     |     |
|------------------------------------|---------|---|-----|-----|
| STD                                | OPTIONS |   |     |     |
| FA                                 | HH      | R | MXS | GFA |
| FA353                              | -       | - | -   | -   |

## GILERA

|                               |       |     |
|-------------------------------|-------|-----|
| DNA 50 (Heng Tong Caliper)    | 01-05 | F   |
| 125 VX/180 VXR (4T)           | 01-04 | F   |
| Runner 125/180 FX/FXR/SP (2T) | 99-02 | F   |
| Runner 50 PJ/SP               | 06-07 | F   |
| VXR 200 Runner (4T)           | 02-04 | F   |
| Nexus 125                     | 07    | F&R |
| Nexus 250 ie                  | 07    | F&R |
| VX 125 Runner (4T)            | 05-07 | F   |
| VX 200 Runner (4T)            | 05-07 | F   |

## KEEWAY

|                |    |     |
|----------------|----|-----|
| K2 125/150/250 | 07 | F&R |
|----------------|----|-----|

## PIAGGIO/VESPA

|  |       |     |
|--|-------|-----|
| Fly 50 (2T/4T)                         | 05-07 | F   |
| Fly 100                                | 07    | F   |
| Beverley 125                           | 07    | F   |
| Beverly B125                           | 02-06 | F&R |
| Beverley S 125                         | 07    | f&r |
| Fly 125/150                            | 05-07 | F   |
| GT 125 L Granturismo Heng Tong Caliper | 03-06 | F   |
| GTV 125                                | 07    | F   |
| Skipper ST 125/150 4T                  | 00-04 | F   |
| Super Hexagon GTX 125/180 (11" wheels) | 00    | F   |
| Super Hexagon 125/180 (12" wheels)     | 01-03 | F   |

|   |       |         |
|---|-------|---------|
| X8 125                                      | 04-06 | F       |
| X8 125 ie                                   | 07    | F       |
| X8 125/Street                               | 07    | F       |
| X9 125                                      | 06-07 | F(left) |
| X8 150 Street                               | 07    | F       |
| Beverly B 200                               | 02-05 | F&R     |
| GT 200 L Granturismo Heng Tong Caliper      | 03-06 | F       |
| X8 200                                      | 04-05 | F       |
| Beverly 250                                 | 06    | F&R     |
| Beverley 250 ie                             |       | F&R     |
| Beverley S 250 ie                           | 07    | F&R     |
| GTS 250 ie/ABS                              | 05-07 | F       |
| GTV 250 ie                                  | 07    | F       |
| GT 60 (Special Anniversary Model) (GTV 250) | 06    | F       |
| X8 250 ie                                   | 05-06 | F       |
| X8 2560 ie                                  | 07    | F       |
| X9 250                                      | 05-06 | F(left) |
| Beverley 400 ie                             | 07    | R       |
| X8 400 ie                                   | 07    | F       |

# FA354R 97 x 51.7 x 6.95mm

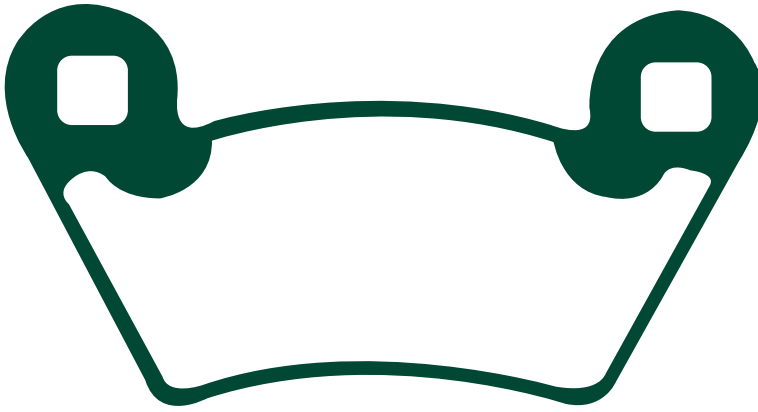

## POLARIS

|  |       |     |
|--|-------|-----|
| Ranger (2x4/4x4)                         | 02-04 | F&R |
| UTV 2x4 (Utility task vehicle series 10) | 03    | F&R |
| PPS/UTV/Series 10 2x4                    |       | F&R |
| PPS/UTV/Series 10 4x6                    |       | F&R |
| PPS/Series II UTV 1500 2x4               |       | F&R |
| Ranger Series 10                         |       | F&R |
| Ranger Series 10 "500 6x6"               |       | F&R |
| Ranger Series 11                         |       | F&R |
| PPS/Series 11 2x4/4x4                    |       | F&R |
| PPS/Series 11 6x6                        |       | F&R |
| Ranger 6x6                               | 04-05 | F&R |
| Ranger TM                                | 04-05 | F&R |
| Ranger XP                                | 05    | F&R |
| Ranger 2x4/4x4                           | 04-06 | R   |
| Ranger 500 (2x4/4x4)                     | 06    | F&R |
| Ranger 500 (4x4 EFi)                     | 06    | F&R |
| Ranger 6x6 EFi 700                       | 06    | F&R |
| Ranger XP 700 4x4                        | 06    | F&R |
| Ranger TM                                | 06    | F&R |

### Equivalents OE #

|          |
|----------|
| 191 0514 |
| 2202413  |

### Competitor X Ref

| MATERIAL AVAILABILITY AND PART NO. |         |        |     |     |
|------------------------------------|---------|--------|-----|-----|
| STD                                | OPTIONS |        |     |     |
| FA                                 | HH      | R      | MXS | GFA |
| -                                  | -       | FA354R | -   | -   |

| Dunlop | Ferodo | SBS | Vesrah |
|--------|--------|-----|--------|
| -      | -      | 800 | VD9024 |

# FA355 44.9 x 50.75 x 7mm

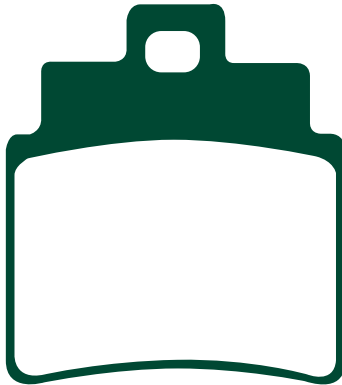

## ARCTIC CAT

DVX 250 06 R

## KYMCO

|                       |       |   |
|-----------------------|-------|---|
| Grand Dink 250        | 01-06 | F |
| KXR 250 Mongoose Quad | 04-07 | R |
| MXU 250               | 04-07 | R |
| Urban Quad 250        | 06    | R |
| Maxxer 300            | 06-07 | R |

## GILERA

Oregon 250 Quad 07 R

## MASAI

|            |       |   |
|------------|-------|---|
| A 300 Quad | 05-07 | R |
| A 450 Quad | 05-07 | R |

## SYM

|             |    |   |
|-------------|----|---|
| Voyager 250 | 05 | F |
| Voymax 250  | 06 | F |

### Equivalents OE #

|                 |          |
|-----------------|----------|
| 45105 HMA 000A  | 00156924 |
| 45106 KKC4 9000 |          |

### Competitor X Ref

| MATERIAL AVAILABILITY AND PART NO. |         |        |     |     |
|------------------------------------|---------|--------|-----|-----|
| STD                                | OPTIONS |        |     |     |
| FA                                 | HH      | R      | MXS | GFA |
| FA355                              | -       | FA355R | -   | -   |

| Dunlop | Ferodo | SBS | Vesrah |
|--------|--------|-----|--------|
| -      | -      | 775 | -      |

# FA356 55.5 x 46 x 7.1mm

**KYMCO**

Grand Dink 250

01-06 R

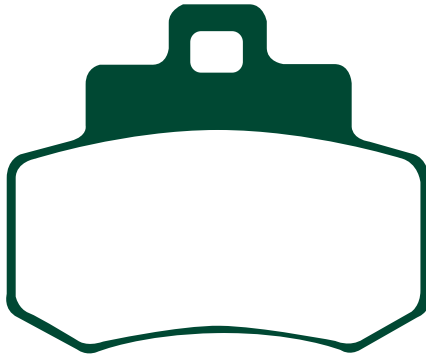

**Equivalents OE #**

43105 KKC4 9000

**Competitor X Ref**

| MATERIAL AVAILABILITY AND PART NO. |         |   |     |     |
|------------------------------------|---------|---|-----|-----|
| STD                                | OPTIONS |   |     |     |
| FA                                 | HH      | R | MXS | GFA |
| FA356                              | -       | - | -   | -   |

| Dunlop | Ferodo | SBS | Vesrah |
|--------|--------|-----|--------|
| -      | -      | 776 | -      |

# FA357 62.1 x 31.4 x 6.55mm

**KTM**

65 SX  
SX 85

02-07 F  
03-07 F&R

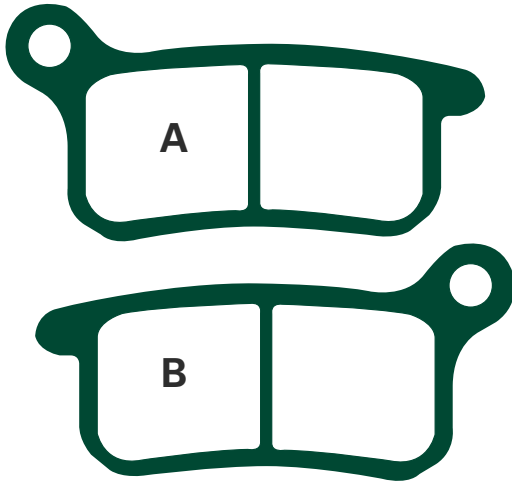

**Equivalents OE #**

461 13 030 000  
470 13 090 000

**Competitor X Ref**

| MATERIAL AVAILABILITY AND PART NO. |         |        |     |     |
|------------------------------------|---------|--------|-----|-----|
| STD                                | OPTIONS |        |     |     |
| FA                                 | HH      | R      | MXS | GFA |
| FA357TT                            | -       | FA357R | -   | -   |

| Dunlop | Ferodo  | SBS | Vesrah |
|--------|---------|-----|--------|
| DP924  | FDB2157 | 783 | -      |



# FA358 A. 86.1 x 40 x 8.9mm

B. 86.1 x 40 x 8.9mm

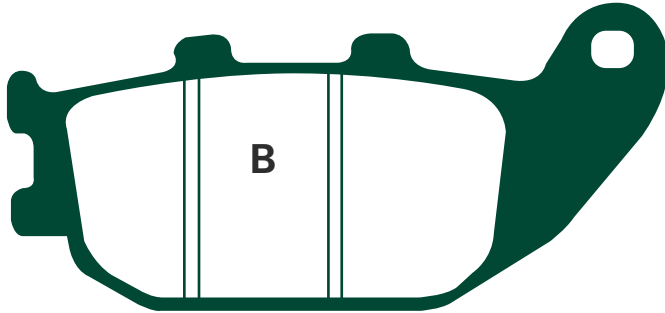
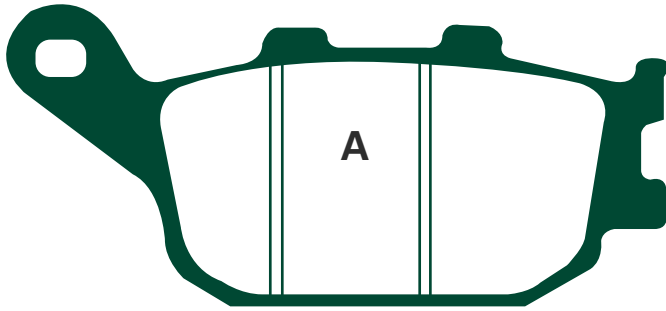

## HONDA

NSS 250 Y/AY/1/A1/A3/3 Forza/Forza-S  
/Forza-T/Forza-ST/Jazz/Reflex  
(MF04/MF06)

00-04 R

### Equivalents OE #

06435 KPB 016

| MATERIAL AVAILABILITY AND PART NO. |         |   |     |     |
|------------------------------------|---------|---|-----|-----|
| STD                                | OPTIONS |   |     |     |
| FA                                 | HH      | R | MXS | GFA |
| FA358                              | -       | - | -   | -   |

### Competitor X Ref

| Dunlop | Ferodo | SBS | Vesrah |
|--------|--------|-----|--------|
| DP928  | -      | 753 | VD169  |

# FA363 A. 94 x 37.3 x 8.6mm

B. 94 x 37.3 x 10.1mm



## BMW

|                                   |       |   |
|-----------------------------------|-------|---|
| R 850 C                           | 97-00 | R |
| R 850 GS                          | 96-00 | R |
| R 850 R                           | 94-06 | R |
| R 850 RT                          | 96-01 | R |
| R 850 RT                          | 06    | R |
| R 1100 GS                         | 93-99 | R |
| R 1100 R                          | 93-01 | R |
| R 1100 S                          | 96-06 | R |
| R 1100 RT                         | 94-01 | R |
| R 1150 GS                         | 98-04 | R |
| R 1150 R                          | 01-06 | R |
| R 1150 RS                         | 01-04 | R |
| R 1150 RT                         | 00-04 | R |
| R 1150 R Rockster                 | 03-06 | R |
| HP2 1200 Enduro                   | 05-07 | R |
| R 1200                            | 00-02 | R |
| R 1200 C                          | 96-04 | R |
| R 1200 GS                         | 04-06 | R |
| K 1200 S (K40)                    | 05-06 | R |
| K 1200 R                          | 05-06 | R |
| R 1200 ST (K28)                   | 03-07 | R |
| R 1200 RT (K26)                   | 03-07 | R |
| R 1200 S                          | 06-07 | R |
| R 1200 R Sport                    | 06-07 | R |
| K 1200 R Sport                    | 07    | R |
| HP2 Megamoto                      | 07    | R |
| R 1200 GS Adventure (Spoke wheel) | 07    | R |

### Equivalents OE #

34 21 2 314 947  
34 21 2 335 465  
34 21 2 330 633  
34 21 7 660 281

| MATERIAL AVAILABILITY AND PART NO. |         |   |     |     |
|------------------------------------|---------|---|-----|-----|
| STD                                | OPTIONS |   |     |     |
| FA                                 | HH      | R | MXS | GFA |
| FA363                              | FA363HH | - | -   | -   |

### Competitor X Ref

| Dunlop | Ferodo  | SBS | Vesrah |
|--------|---------|-----|--------|
| -      | FDB2039 | 742 | -      |

# FA366 69.8 x 46.7 x 13.05mm

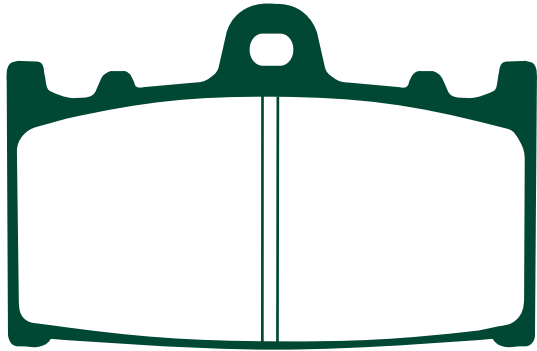

## SUZUKI

VL 1500 K2/K3/K5 Intruder 02-03/05 R  
 VL 1600 K5/K6/K7 (C 1500 Intruder) 05-07 R

### Equivalents OE #

69100 10820

| MATERIAL AVAILABILITY AND PART NO. |         |   |     |     |
|------------------------------------|---------|---|-----|-----|
| STD                                | OPTIONS |   |     |     |
| FA                                 | HH      | R | MXS | GFA |
| FA366TT                            | -       | - | -   | -   |

### Competitor X Ref

| Dunlop | Ferodo  | SBS | Vesrah |
|--------|---------|-----|--------|
| -      | FDB2163 | 789 | -      |

# FA367 66.9 x 36.1 x 10.75mm



1 pad left  
/ 1 pad right

### Equivalents OE #

|              |               |             |
|--------------|---------------|-------------|
| 5UN W0046 00 | K4308 0006    | 69100 35810 |
| 5UN W0046 50 | IC3 W0046 10  | 43082 0048  |
| 5UN W0046 51 | 25.25362.0.00 | 9100797     |
| 43082 0006   | 0631          | 2525345000  |

## APRILIA

RXV 450/550 Enduro 06-07 R  
 SVX 450/550 Supermotard 06-07 R  
 SXV 450 07 R  
 SXV 459 07 R

## BETA

RR 125 (All models) 06-07 R  
 RR 250/400/450/525 Enduro 05-07 R  
 M4 350 Motard 07 R

## KAWASAKI

KX 250 F (KX 250 N1/N2) 04-05 R  
 KX 250 F (T6F/T7F) 06-07 R  
 KX 450 F (D6F/D7F) 06-07 R  
 KLX 450 R (A8F) 07 R

## SHERCO

4.5i (450 SM/LT) 04-07 R  
 4.5i Enduro (4T) 06-07 R  
 5.1i Enduro 06-07 R  
 5.1i Supermotard 06-07 R

## SUZUKI

RM-Z 250 K4/K5/K6/K7 04-07 R  
 RM-Z 450 K5/K6/K7 05-07 R

## TM

SMX 660 06 R

## YAMAHA

YZ 125 R/S/T/V/W 03-07 R  
 YZ 250 R/S/T/V/W 03-07 R  
 YZ 250 FR/FS/FT/FV/FW 03-07 R  
 WR 250 FR/FS/FT/FV/FW 03-07 R  
 WR 450 FR/FS/FT/FV/FW 03-07 R  
 YZ 450 FR/FS/FT/FV 03-06 R

### Competitor X Ref

| MATERIAL AVAILABILITY AND PART NO. |         |        |        |          | Dunlop | Ferodo  | SBS | Vesrah |
|------------------------------------|---------|--------|--------|----------|--------|---------|-----|--------|
| STD                                | OPTIONS |        |        |          |        |         |     |        |
| FA                                 | HH      | R      | MXS    | GFA      |        |         |     |        |
| FA367TT                            | -       | FA367R | MXS367 | GFA367HH | DP940  | FDB2162 | 790 | VD271  |

# FA368 A. 64 x 41.6 x 9.25mm

## B. 64 x 41.6 x 9.25mm



### Equivalents OE #

|                |
|----------------|
| 548 13 090 000 |
| 548 13 090 100 |
| 8000A2790      |
| 548 13 090 300 |

### Competitor X Ref

| Dunlop | Ferodo  | SBS | Vesrah |
|--------|---------|-----|--------|
| DP935  | FDB2165 | 791 | -      |

| MATERIAL AVAILABILITY AND PART NO. |         |        |        |          |
|------------------------------------|---------|--------|--------|----------|
| STD                                | OPTIONS |        |        |          |
| FA                                 | HH      | R      | MXS    | GFA      |
| FA368TT                            | -       | FA368R | MXS368 | GFA368HH |

### HUSQVARNA

|                             |       |   |
|-----------------------------|-------|---|
| CR 125                      | 05-07 | R |
| WR 125                      | 06-07 | R |
| CR 250                      | 05    | R |
| TC 250                      | 05-07 | R |
| TE 250                      | 06-07 | R |
| WR 250                      | 06-07 | R |
| TE 410                      | 06    | R |
| SMR 450 RR (Radial caliper) | 06-07 | R |
| SM 450 R Radial Caliper     | 07    | R |
| TC 450                      | 05-07 | R |
| TE 450                      | 06-07 | R |
| SM 510 R (Radial caliper)   | 06-07 | R |
| TC 510                      | 05-07 | R |
| TE 510                      | 06-07 | R |

### KTM

|                   |       |   |
|-------------------|-------|---|
| SX 125            | 04-07 | R |
| EXC 125           | 04-07 | R |
| EXC 200           | 04-07 | R |
| SX 250            | 03-07 | R |
| SX-F 250          | 06-07 | R |
| EXC 250           | 04-07 | R |
| EXC 250 Racing    | 06    | R |
| EXC-F 250         | 06-07 | R |
| EXC 300           | 04-07 | R |
| EXC 400 Racing    | 06-07 | R |
| EXC 450 Racing    | 06-07 | R |
| SMR 450           | 04-06 | R |
| SX-F 450          | 03-07 | R |
| EXC 450           | 04-05 | R |
| SMR 450           | 07    | R |
| SX-F 505          | 07    | R |
| SMR 525           | 04    | R |
| SX 525            | 03-06 | R |
| EXC 525           | 04-05 | R |
| XC 525 Racing     | 06-07 | R |
| SMR 560           | 07    | R |
| SXC 625           | 05-06 | R |
| SMR 650 Supermoto | 06    | R |
| SMR 525           | 05    | R |

### YAMAHA

|           |    |   |
|-----------|----|---|
| YZ 450 FW | 07 | R |
|-----------|----|---|

# FA369/4HH 49.2 x 38.6 x 7.75mm

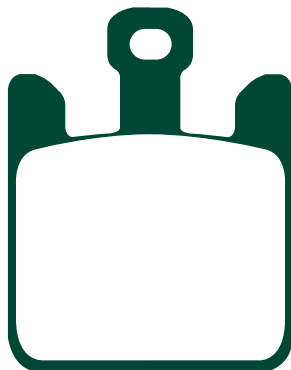

### KAWASAKI

|                                 |       |   |
|---------------------------------|-------|---|
| ZX-6RR (ZX 600 K1/M1/N1/N6F)    | 03-06 | F |
| ZX6R (ZX 636 B1/B2/C1/C6F)      | 03-06 | F |
| ZX 10 R (ZX 1000 C1/C2/D6F/D7F) | 04-07 | F |
| ZX 12 R (ZX 1200 B3/B4/B6F)     | 04-06 | F |
| VN 1600 B2H/B6F (Mean Streak)   | 05-06 | F |

### SUZUKI

|                              |    |   |
|------------------------------|----|---|
| GSXR 1000 K3                 | 03 | F |
| VZ 1600 K5 (M 1600 Intruder) | 05 | F |

### Equivalents OE #

|             |            |            |
|-------------|------------|------------|
| 59100 18851 | 43082 0019 | 43082 0037 |
| 43082 1293  | 43082 0021 |            |
| 43082 0018  | 43082 0031 |            |

### Competitor X Ref

| MATERIAL AVAILABILITY AND PART NO. |           |   |     |            | Dunlop | Ferodo  | SBS | Vesrah |
|------------------------------------|-----------|---|-----|------------|--------|---------|-----|--------|
| STD                                | OPTIONS   |   |     |            | DP942  | FDB2164 | 788 | VD354  |
| FA                                 | HH        | R | MXS | GFA        |        | FDB2203 |     |        |
| -                                  | FA369/4HH | - | -   | GFA369/4HH |        |         |     |        |

# FA372R

A. 37 x 55.5 x 10.94mm  
B. 85 x 35 x 8.7mm

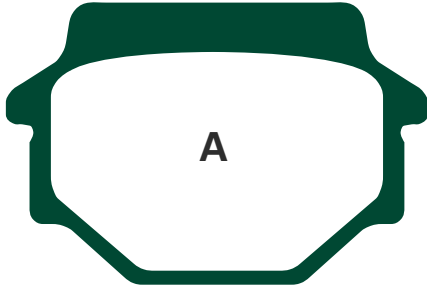

**SUZUKI**

LT-A 500 FK3/FK4/FK5/FK6/FK7 Vinson 4WD Auto 03-07 R  
LT-F 500 FK3/FK4/FK5/FK6/FK7 03-07 R

**Equivalents OE #**

|             |
|-------------|
| 69100 03850 |
| 69100 03860 |

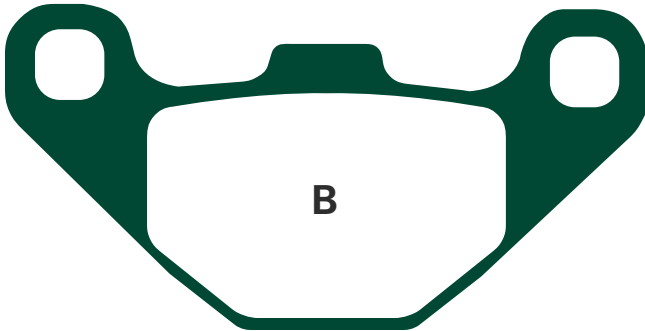

**Competitor X Ref**

| MATERIAL AVAILABILITY AND PART NO. |         |        |     |     |
|------------------------------------|---------|--------|-----|-----|
| STD                                | OPTIONS |        |     |     |
| FA                                 | HH      | R      | MXS | GFA |
| -                                  | -       | FA372R | -   | -   |

| Dunlop | Ferodo | SBS | Vesrah |
|--------|--------|-----|--------|
| -      | -      | -   | -      |

# FA373R

75.35 x 39.35 x 11.75mm

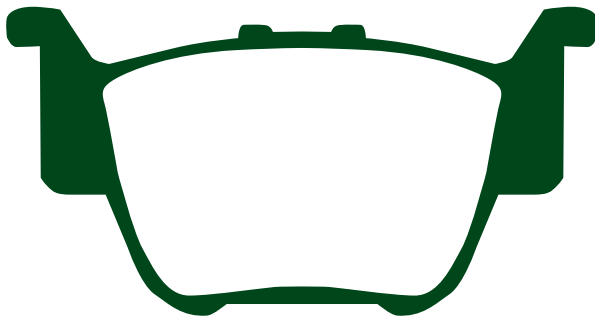

**Equivalents OE #**

|               |
|---------------|
| 06435 HN8 006 |
| 06435 HP1 006 |

**HONDA**

TRX 450 R4/R5/R6/ER6/R7/ER7 04-07 R  
TRX 650 FA3/FA4/FA5 Rincon 03-05 R  
TRX 680 FGA6/FA6/7 Fourtrax Rincon 06-07 R

**Competitor X Ref**

| MATERIAL AVAILABILITY AND PART NO. |         |        |     |     |
|------------------------------------|---------|--------|-----|-----|
| STD                                | OPTIONS |        |     |     |
| FA                                 | HH      | R      | MXS | GFA |
| -                                  | -       | FA373R | -   | -   |

| Dunlop | Ferodo  | SBS | Vesrah |
|--------|---------|-----|--------|
| DP944  | FDB2182 | 813 | VD171  |

# FA374 A. 95.5 x 42 x 8mm

B. 77 x 42 x 8mm

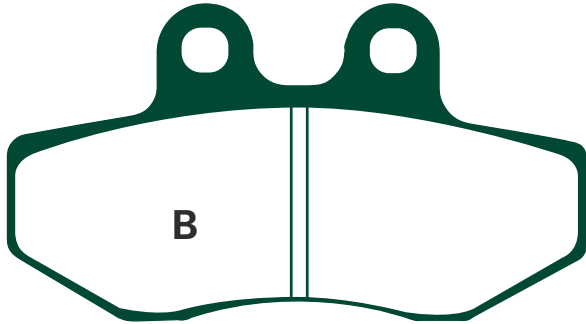
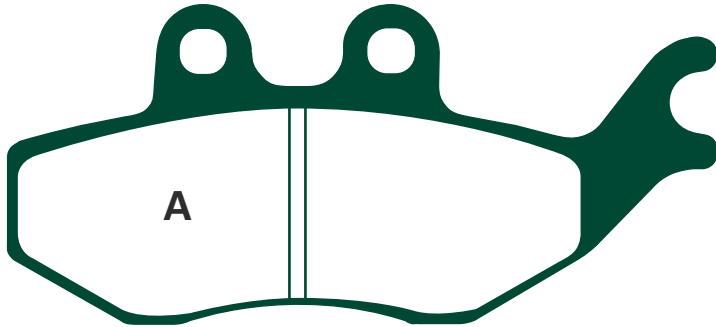

### ITALJET

Jupiter 250

02-03 R

### RIEJU

NKD 50

07 F

RS2 Matrix (50cc)

02-07 F

RS2 125

06-07 F

125 NKD

06-07 F

### Equivalents OE #

|             |
|-------------|
| 4716610     |
| 00009307000 |

### Competitor X Ref

| Dunlop | Ferodo  | SBS | Vesrah |
|--------|---------|-----|--------|
| -      | FDB2147 | 780 | VD9013 |

### MATERIAL AVAILABILITY AND PART NO.

| STD   | OPTIONS |   |     |     |
|-------|---------|---|-----|-----|
| FA    | HH      | R | MXS | GFA |
| FA374 | -       | - | -   | -   |

# FA375 A. 110.6 x 34.6 x 7.6mm

B. 98.7 x 33.5 x 7.5mm

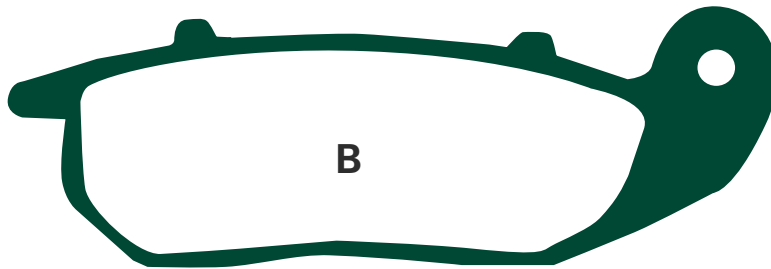
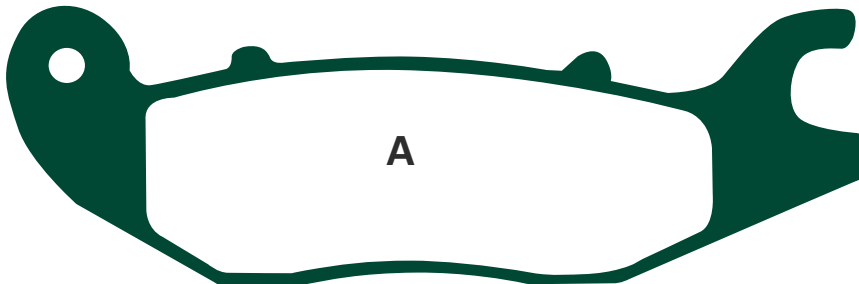

### AJS

Regal Raptor CR3-125

06 F

### HONDA

ANF 125 3/S/T5/6/7

03-07 F

CBR 125 RR4/RR5/RS5/RWS

/RR6/RS6/R7

04-07 F

FS 125 Sonic

03-04 R

CBR 150 R

00-03 F

### LIFAN

Smart 50/125

F

### SUPERBYKE

CQ 50 Road Classic

F

CU 125 Road Classic

F

### Equivalents OE #

|               |
|---------------|
| 06455 KPH 951 |
| 06455 KPP 901 |

### Competitor X Ref

| Dunlop | Ferodo  | SBS | Vesrah |
|--------|---------|-----|--------|
| -      | FDB2169 | 797 | -      |

### MATERIAL AVAILABILITY AND PART NO.

| STD   | OPTIONS |   |     |     |
|-------|---------|---|-----|-----|
| FA    | HH      | R | MXS | GFA |
| FA375 | -       | - | -   | -   |

# FA377 A. 94 x 46 x 8.5mm B. 73 x 46 x 11mm

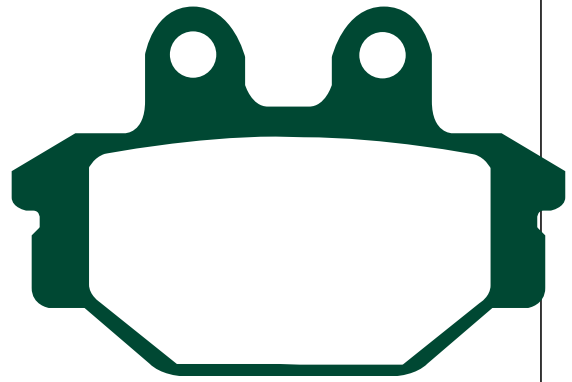
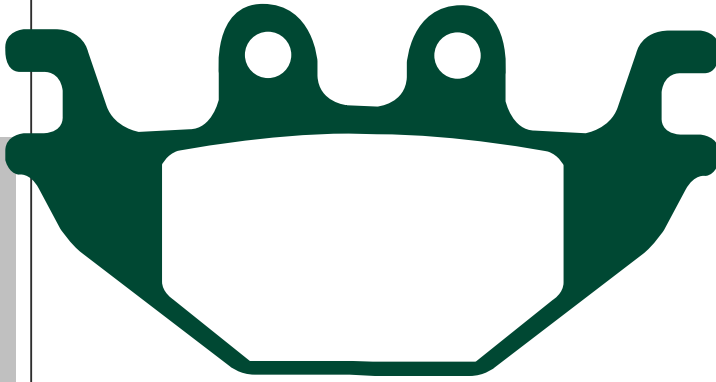

|                                       |       |     |
|---------------------------------------|-------|-----|
| <b>ADLY</b><br>Interceptor 300        | 06    | F   |
| <b>ARCTIC CAT</b><br>DVX 250          | 06    | F   |
| <b>BOMBARDIER</b><br>DS 250           | 06    | F&R |
| <b>CAN-AM</b><br>DS 250 (3J7A/B)      | 07    | F&R |
| <b>CPI</b><br>XS 250 Quad             | 06-07 | F   |
| <b>KYMCO</b><br>KXR 250 Mongoose Quad | 04-07 | F   |
| MXU 250                               | 04-07 | F   |
| Urban Quad 250                        | 06    | F   |
| MXU 300                               | 06-07 | F&R |
| Maxxer 300                            | 06-07 | F   |
| MXU 500 (4x4)                         | 06-07 | F&R |
| <b>PGO</b><br>BR-500i Racer           | 07    | R   |
| <b>SYM</b><br>Trackrunner 200 Quad    | 05-07 | F   |
| Quadlander 250                        | 05-07 | F   |
| Outlander 300 S                       | 07    | F&R |
| Citymax 300 Quad                      | 06    | F   |
| Quadraider 600                        | 06    | R   |
| <b>TGB</b><br>Outback 425 Quad        | 07    | F&R |

**Equivalents OE #**

|                 |              |
|-----------------|--------------|
| 45105 LB17 3050 | S4311ARCA000 |
| 00157056        | 515049       |
| S4511ARCA000    | 515050       |

**Competitor X Ref**

| Dunlop | Ferodo  | SBS | Vesrah |
|--------|---------|-----|--------|
| DP967  | FDB2184 | 810 | VD9026 |

**MATERIAL AVAILABILITY AND PART NO.**

| STD   | OPTIONS |        |     |     |
|-------|---------|--------|-----|-----|
| FA    | HH      | R      | MXS | GFA |
| FA377 |         | FA377R |     |     |

# FA379HH 71.45 x 49.9 x 7.76mm

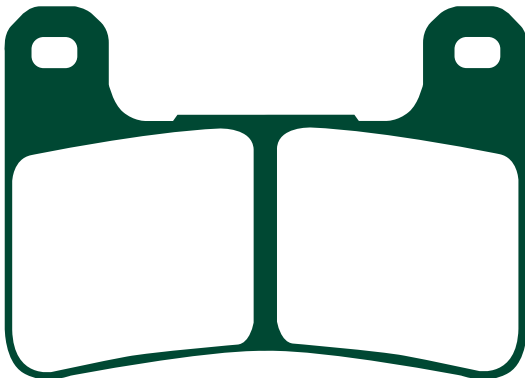

**SUZUKI**

|                                    |       |   |
|------------------------------------|-------|---|
| GSXR 600 K4/K5/K6/K7               | 04-07 | F |
| GSXR 750 K4/K5/K6/K7               | 04-07 | F |
| GSXR 1000 K4/K5/K6/K7              | 04-07 | F |
| VZR 1800 K6/K7 (M 1800 R Intruder) | 06-07 | F |

**Equivalents OE #**

|             |
|-------------|
| 59100-29820 |
| 59100-29840 |
| 59100 29850 |

**Competitor X Ref**

| Dunlop | Ferodo             | SBS | Vesrah |
|--------|--------------------|-----|--------|
| DP947  | FDB2178<br>FDB2204 | 306 | VD355  |

**MATERIAL AVAILABILITY AND PART NO.**

| STD | OPTIONS |   |     |          |
|-----|---------|---|-----|----------|
| FA  | HH      | R | MXS | GFA      |
| -   | FA379HH |   |     | GFA379HH |

# FA380HH 50.4 x 69 x 8.7mm

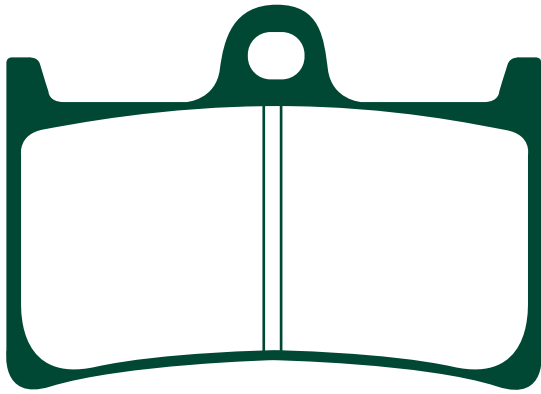

### YAMAHA

|                                       |       |   |
|---------------------------------------|-------|---|
| FZ6 Fazer S2 (ABS) (4 piston caliper) | 07    | F |
| YZF R6                                | 04-07 | F |
| YZF R6S                               | 07    | F |
| YZF R1                                | 04-06 | F |
| FZ1-N/NV (Naked) (1000cc) (2D11/2/3)  | 06-07 | F |
| FZ1-S/FZ1-SV                          | 06-07 | F |
| MT-01 (1670cc)                        | 05-06 | F |
| YZF-R1SP                              | 06    | F |

Equivalents OE # 5VY W0045 00

### Competitor X Ref

| Dunlop | Ferodo | SBS | Vesrah    |
|--------|--------|-----|-----------|
| DP418  | FDB605 | 634 | VD248/274 |

| MATERIAL AVAILABILITY AND PART NO. |         |   |     |          |
|------------------------------------|---------|---|-----|----------|
| STD                                | OPTIONS |   |     |          |
| FA                                 | HH      | R | MXS | GFA      |
| -                                  | FA380HH |   |     | GFA380HH |

# FA381 103 x 48 x 10.9mm

Total thickness with refitted O/E shim & insulator  
(size of pad on its own 8.9mm)

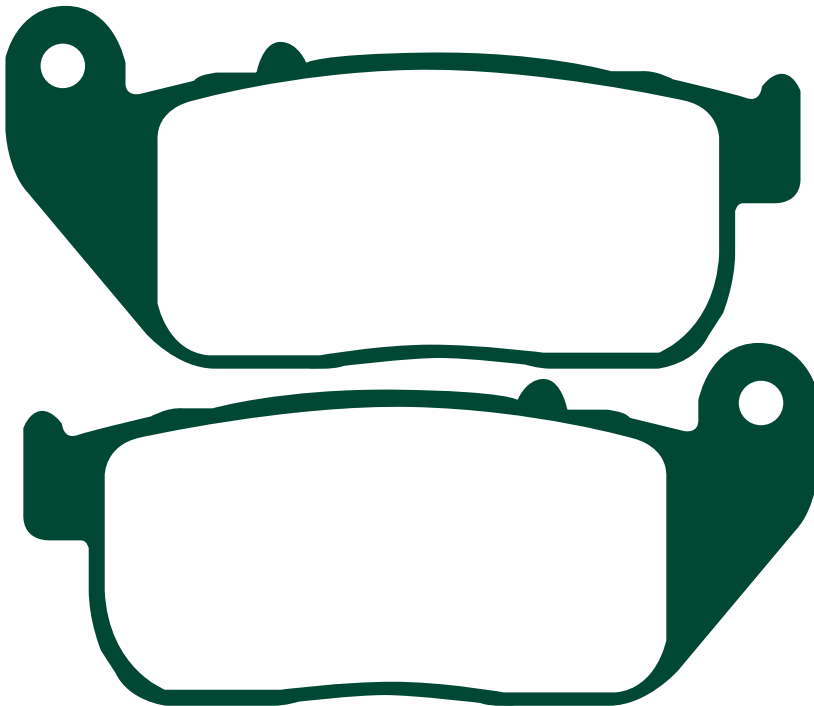

**NOTE: Only refit shim & insulator to HH pads**

### HARLEY DAVIDSON

|                                  |       |   |
|----------------------------------|-------|---|
| XL 50 50th Anniversary Sportster | 07    | F |
| XL 883 Sportster STD             | 04-07 | F |
| XL 883C Sportster Custom         | 04-07 | F |
| XL 883 R Sportster               | 05-07 | F |
| XL 1200 C Sportster Custom       | 04-07 | F |
| XL 1200 R Sportster Roadster     | 04-07 | F |
| XL 1200 L Sportster Low          | 07    | F |

### Equivalents OE #

42831-04

### MATERIAL AVAILABILITY AND PART NO.

| STD   | OPTIONS |   |     |     |
|-------|---------|---|-----|-----|
| FA    | HH      | R | MXS | GFA |
| FA381 | FA381HH |   |     |     |

### Competitor X Ref

| Dunlop | Ferodo  | SBS | Vesrah   |
|--------|---------|-----|----------|
| DP948  | FDB2179 | 807 | VD9009JL |

**FA382** A. 85.12 x 42.70 x 7.4mm  
B. 56 x 34.75 x 9.6mm

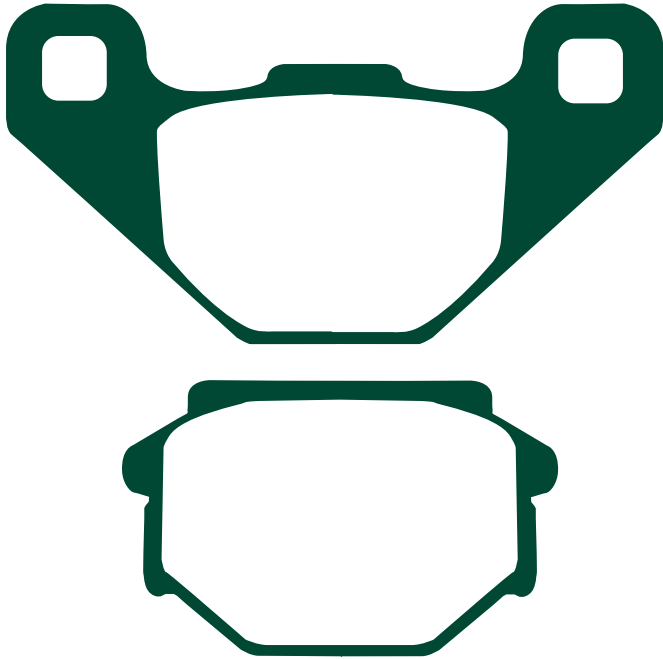

**APRILIA**

|                        |       |   |
|------------------------|-------|---|
| MX 125                 | 04-06 | R |
| Tuareg Rally 125       | 89-93 | R |
| Tuareg Rally 125 (L/M) | 90-91 | R |
| RX 125                 | 92-01 | R |
| Pegaso 125             | 91    | R |
| Pegaso 125 KAT         | 94-95 | R |
| Pegaso 600             | 91    | R |
| Tuareg Wind 600        | 89    | R |

**BETA (Street)**

|         |    |   |
|---------|----|---|
| ALP 4.0 | 04 | R |
|---------|----|---|

**HONDA HM (Italy)**

|   |       |     |
|---|-------|-----|
| CRE 50 Six                                  | 01-02 | R   |
| CRE 50 Six/Baja/Derapae                     | 95-02 | R   |
| CRE 50 Six/Baja/Derapage<br>Grimeca caliper | 95-02 | F&R |

**MZ**

|               |       |   |
|---------------|-------|---|
| 660 Supermoto | 06-07 | R |
|---------------|-------|---|

**SACHS**

|                    |       |   |
|--------------------|-------|---|
| XTC 125 Supersport | 00-07 | R |
| X Road 125         | 06    | R |
| Roadster 650       | 01-04 | R |

**YAMAHA**

|                            |       |   |
|----------------------------|-------|---|
| DT 50 R-L (SM-5VB1/VG55BK) | 02-03 | F |
|----------------------------|-------|---|

**Equivalents OE #**

|              |
|--------------|
| 5VB W0045 00 |
| 8113375      |
| KA3497506    |

**Competitor X Ref**

| Dunlop | Ferodo | SBS | Vesrah |
|--------|--------|-----|--------|
| -      | -      | 682 | -      |

**MATERIAL AVAILABILITY AND PART NO.**

| STD   | OPTIONS |   |     |     |
|-------|---------|---|-----|-----|
| FA    | HH      | R | MXS | GFA |
| FA382 |         |   |     |     |

**FA384** A. 99 x 42.5 x 8mm  
B. 77.1 x 40.8 x 8.95mm

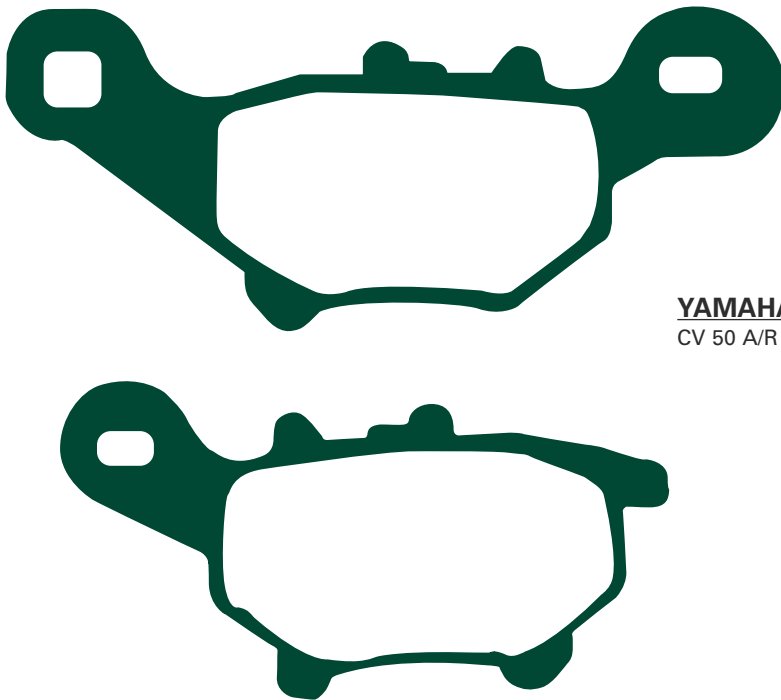

**YAMAHA**

|                        |    |   |
|------------------------|----|---|
| CV 50 A/R Jog (5SU1/2) | 03 | F |
|------------------------|----|---|

**Equivalents OE #**

|              |
|--------------|
| 5SU W0045 00 |
|--------------|

**Competitor X Ref**

| Dunlop | Ferodo | SBS | Vesrah |
|--------|--------|-----|--------|
| -      | -      | -   | -      |

**MATERIAL AVAILABILITY AND PART NO.**

| STD   | OPTIONS |   |     |     |
|-------|---------|---|-----|-----|
| FA    | HH      | R | MXS | GFA |
| FA384 |         |   |     |     |



# FA387 87 x 50 x 10.4mm (Note refit o/e shim to HH pads only)



**Equivalents OE #**

42836-04

**HARLEY DAVIDSON**

|                                  |       |   |
|----------------------------------|-------|---|
| XL 50 50th Anniversary Sportster | 07    | R |
| XL 883 Sportster Standard        | 04-07 | R |
| XL 883 (XL53X) Sportster Custom  | 04-07 | R |
| XL 883 R Sportster               | 05-07 | R |
| XL 1200 C Sportster Custom       | 04-07 | R |
| XL 1200 R Sportster Roadster     | 04-07 | R |
| XL 1200 L Sportster Low          | 07    | R |

**Competitor X Ref**

|                        |                          |                   |                           |
|------------------------|--------------------------|-------------------|---------------------------|
| <b>Dunlop</b><br>DP949 | <b>Ferodo</b><br>FDB2180 | <b>SBS</b><br>808 | <b>Vesrah</b><br>VD9010JL |
|------------------------|--------------------------|-------------------|---------------------------|

**MATERIAL AVAILABILITY AND PART NO.**

| STD   | OPTIONS |   |     |     |
|-------|---------|---|-----|-----|
| FA    | HH      | R | MXS | GFA |
| FA387 | FA387HH |   |     |     |

# FA388HH 118 x 47 x 8.3mm (Refit O/E shim)

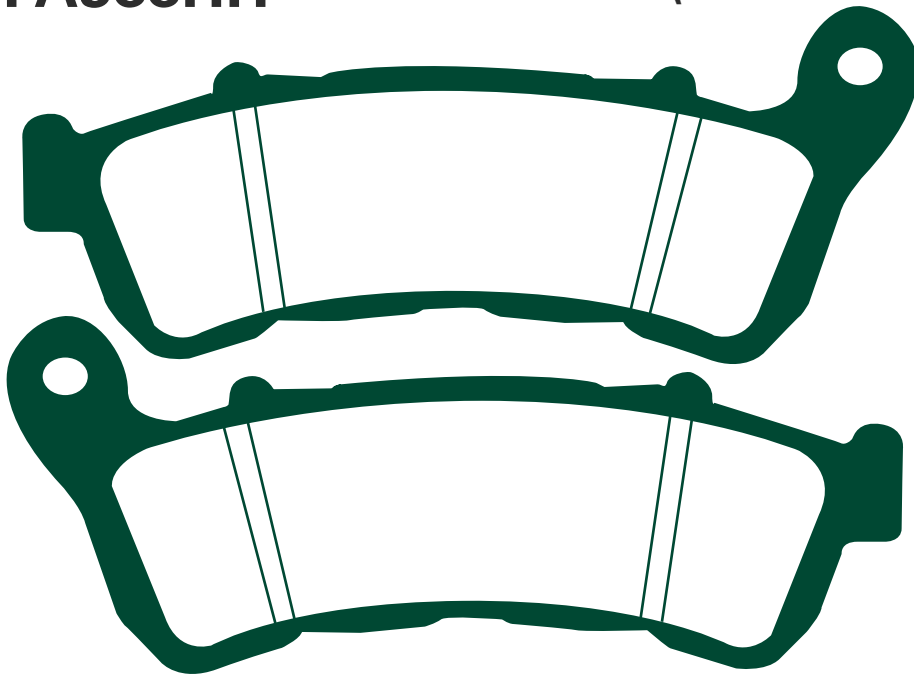

**Equivalents OE #**

|               |
|---------------|
| 06455 MBT D51 |
| 06455 MET 651 |
| 06455 KSV J03 |
| 06455 KSV J41 |
| 06455 KSV J01 |
| 06455 MCW H01 |
| 06456 MCW H01 |
| 06455 MFA D11 |
| 06455 KTW 901 |

**HONDA**

|                                  |       |   |
|----------------------------------|-------|---|
| NSS 250 EX5/EX6 (ABS) Forza EX   | 05-06 | F |
| NSS 250 AX5/AX6/A7 (ABS) Forza Z | 05-07 | F |
| PS 250 5/6 Big Ruckus            | 05-06 | F |
| SH 300i A7                       | 07    | F |
| CBF 500 A4/A5/A6 (ABS)           | 04-07 | F |
| CB 600 AF7 Hornet (ABS)          | 07    | F |

|  |       |     |
|--|-------|-----|
| NT 700 V6/VA7 Deauville                | 06-07 | F   |
| VFR 800 6/7/A6/A7                      | 06-07 | F   |
| CBF 1000 FA6/FA7 (ABS Model)           | 06-07 | F&R |
| XL 1000 VA4/VA5/VA6/VA7 Varadero (ABS) | 04-07 | F   |

**SUZUKI**

|                   |    |   |
|-------------------|----|---|
| UH 125 K7 Burgman | 07 | F |
| UH 200 K7 Burgman | 07 | F |

**Competitor X Ref**

|                        |                          |                   |                        |
|------------------------|--------------------------|-------------------|------------------------|
| <b>Dunlop</b><br>DP954 | <b>Ferodo</b><br>FDB2196 | <b>SBS</b><br>828 | <b>Vesrah</b><br>VD172 |
|------------------------|--------------------------|-------------------|------------------------|

**MATERIAL AVAILABILITY AND PART NO.**

| STD   | OPTIONS |   |     |     |
|-------|---------|---|-----|-----|
| FA    | HH      | R | MXS | GFA |
| FA388 | FA388HH | - | -   | -   |

# FA389 USE FA185TT

## FA390 75 x 48 x 8mm



### HONDA

|                                      |       |   |
|--------------------------------------|-------|---|
| CBF 600 N7 (Radial Caliper)          | 07    | F |
| CBR 600 RR5/RR6/RR7 (Radial Caliper) | 05-07 | F |
| CBR 1000 RR4/RR5/RR6/RR7 Fireblade   | 04-07 | F |

### Equivalents OE #

|               |
|---------------|
| 06455 MEL 003 |
| 06455 MFJ D01 |

### Competitor X Ref

| Dunlop | Ferodo             | SBS | Vesrah |
|--------|--------------------|-----|--------|
| DP950  | FDB2181<br>FDB2205 | 809 | VD170  |

| MATERIAL AVAILABILITY AND PART NO. |         |   |     |          |
|------------------------------------|---------|---|-----|----------|
| STD                                | OPTIONS |   |     |          |
| FA                                 | HH      | R | MXS | GFA      |
|                                    | FA390HH |   |     | GFA390HH |

## FA393 77 x 42 x 9.3mm

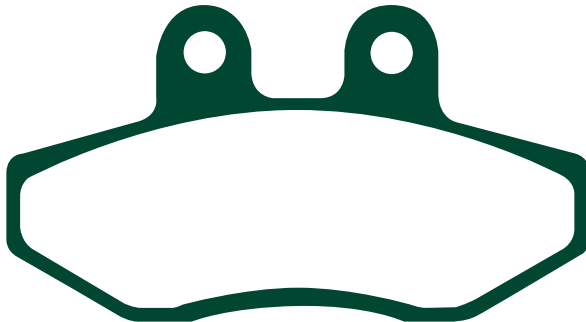

### YAMAHA

XC 125 Cygnus X 04-07 F

### MBK

YP 125 Flamex 04-06 F

### Equivalents OE #

|              |
|--------------|
| 5NW W0045 00 |
|--------------|

### Competitor X Ref

| Dunlop | Ferodo | SBS | Vesrah |
|--------|--------|-----|--------|
| -      | -      | 823 | VD273  |

| MATERIAL AVAILABILITY AND PART NO. |         |   |     |     |
|------------------------------------|---------|---|-----|-----|
| STD                                | OPTIONS |   |     |     |
| FA                                 | HH      | R | MXS | GFA |
| FA393                              | -       | - | -   | -   |

## FA395 95 x 48 x 7mm



### ARCTIC CAT

|                      |       |     |
|----------------------|-------|-----|
| 250 (2x4/4x4)        | 05    | F&R |
| 300 (4x4)            | 05    | F&R |
| 400 FIS/4x4 FIS      | 05    | F&R |
| 500 FIS              | 05    | F&R |
| 500 TRV              | 05    | F&R |
| 650 H1 (4x4 Auto)    | 05    | F&R |
| 650 H1 Auto          | 06    | F&R |
| 650 V-Twin Auto FI5  | 06    | F&R |
| 650 V-Twin 4x4 FI5   | 04-05 | F&R |
| 700 4x4 Auto FI5/EFI | 06-07 | F&R |

### PIAGGIO

Trackmaster 400 Quad 06 F&R

### Equivalents OE #

|          |
|----------|
| 0502-604 |
| 0502-875 |
| 2203045  |

### Competitor X Ref

| Dunlop | Ferodo | SBS | Vesrah |
|--------|--------|-----|--------|
| DP956  | -      | 822 | VD9023 |

| MATERIAL AVAILABILITY AND PART NO. |         |        |     |     |
|------------------------------------|---------|--------|-----|-----|
| STD                                | OPTIONS |        |     |     |
| FA                                 | HH      | R      | MXS | GFA |
| FA395TT                            |         | FA395R |     |     |

# FA396 A. 99.00 x 44.10 x 7.56mm B. 75.50 x 37.90 x 8.26

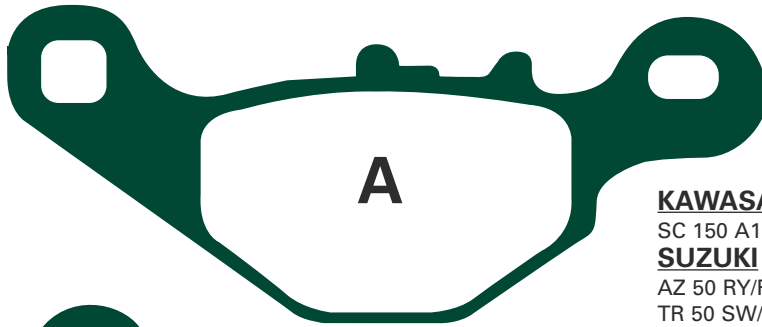

**A**

**KAWASAKI**

SC 150 A1 (Epsilon 150) 02-03 F

**SUZUKI**

AZ 50 RY/RK2 (ZZ Inch Up Sport) 00-02 F  
 TR 50 SW/SX 98-00 F  
 UG 110 W/SW/Y/SY/SK1 Hokuto/Address 98-02 F  
 AN 125 S/T/V/W/XX 95-00 F  
 UC 125 X/Y 'Epicuro' 99-02 F  
 UZ 125 K5/GK5 (CF46A) (V126G) 05 F

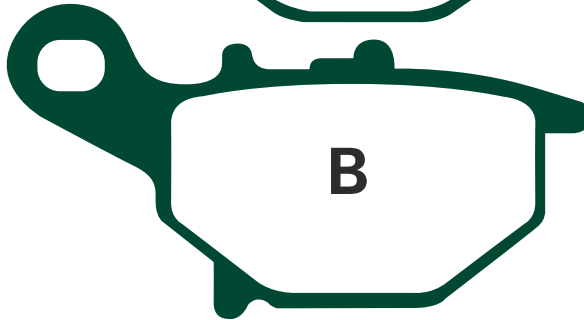

**B**

**Equivalents OE #**

|             |             |
|-------------|-------------|
| 43082 S001  | 59300 20830 |
| 59300 20841 | 59300 20880 |
| 59300 20890 | 59300 20890 |

**Competitor X Ref**

| Dunlop | Ferodo | SBS | Vesrah |
|--------|--------|-----|--------|
| DP218  | -      | 702 | -      |

**MATERIAL AVAILABILITY AND PART NO.**

| STD   | OPTIONS |   |     |     |
|-------|---------|---|-----|-----|
| FA    | HH      | R | MXS | GFA |
| FA396 |         |   |     |     |

# FA398R 95.4 x 39.55 x 6.85mm

**JOHN DEERE**

Gator HPX All models 04-05 F&R



**Equivalents OE #**

|           |
|-----------|
| VGA 12182 |
|-----------|

**Competitor X Ref**

| Dunlop | Ferodo | SBS | Vesrah |
|--------|--------|-----|--------|
| -      | -      | -   | -      |

**MATERIAL AVAILABILITY AND PART NO.**

| STD | OPTIONS |        |     |     |
|-----|---------|--------|-----|-----|
| FA  | HH      | R      | MXS | GFA |
| -   | -       | FA398R | -   | -   |

# FA399 69.65 x 51.55 x 7.25mm

**BLATA**

Enduro 125 07 F  
 Motard 125 07 F

**CONTI**

RX 356 V3 (12" wheels) 05-06 F  
 RX 356 V3 (17" wheels) 05-06 F

**DERBI**

GPR 125/Nude (Radial caliper) 04-06 F  
 Freexter 125 07 F

**GILERA**

SC 125 06-07 F

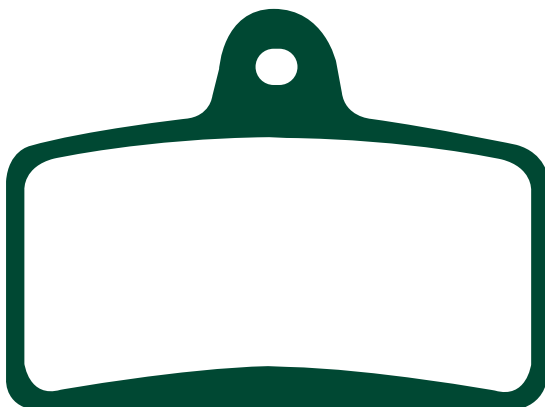

**Competitor X Ref**

| Dunlop | Ferodo  | SBS | Vesrah |
|--------|---------|-----|--------|
| -      | FDB2201 | 821 | -      |

**Equivalents OE #**

|             |
|-------------|
| 00H01201221 |
|-------------|

**MATERIAL AVAILABILITY AND PART NO.**

| STD   | OPTIONS |   |     |     |
|-------|---------|---|-----|-----|
| FA    | HH      | R | MXS | GFA |
| FA399 | -       | - | -   | -   |

# FA400 A. 97.54 x 64.2 x 7.5mm B. 97.54 x 64.2 x 7.5mm

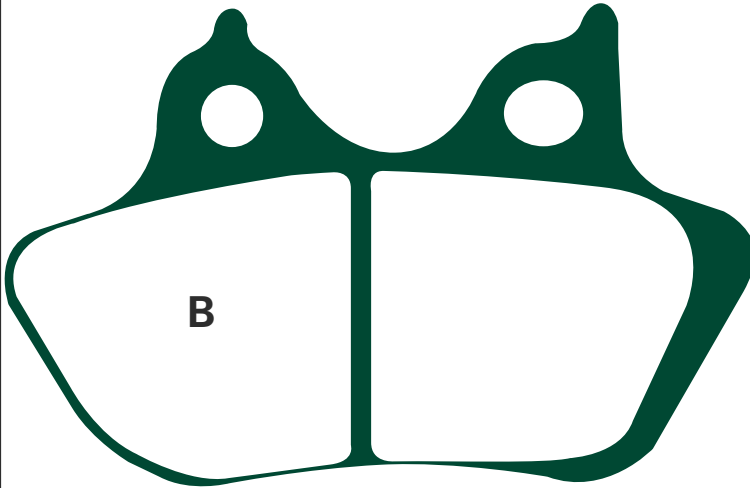

**NOTE: THIS PAD REPLACES  
FA299/299HH**

**HARLEY DAVIDSON**

Most models  
Check application listings for details

06-07 F&R

**Equivalents OE #**

44082 00C

**Competitor X Ref**

|                        |                    |                   |                         |
|------------------------|--------------------|-------------------|-------------------------|
| <b>Dunlop</b><br>DP957 | <b>Ferodo</b><br>- | <b>SBS</b><br>826 | <b>Vesrah</b><br>VD9022 |
|------------------------|--------------------|-------------------|-------------------------|

**MATERIAL AVAILABILITY AND PART NO.**

| STD   | OPTIONS |   |     |     |
|-------|---------|---|-----|-----|
| FA    | HH      | R | MXS | GFA |
| FA400 | FA400HH | - | -   | -   |

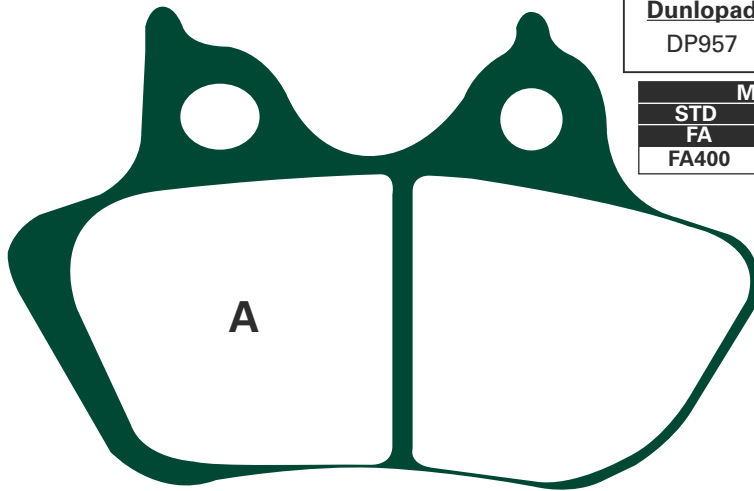

**CHECK PAD SHAPE TO  
CONFIRM CORRECT PAD  
HAS BEEN SELECTED**

# FA401 A. 99 x 40.1 x 7.56mm B. 75.5 x 37.9 x 8.26mm

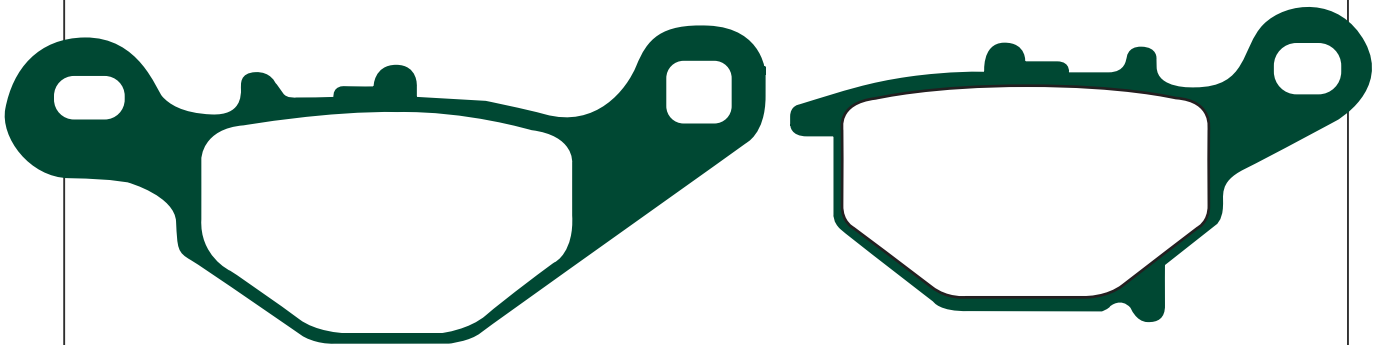

**Equivalents OE #**

69100 03880

**Competitor X Ref**

|                        |                          |                   |                        |
|------------------------|--------------------------|-------------------|------------------------|
| <b>Dunlop</b><br>DP953 | <b>Ferodo</b><br>FDB2197 | <b>SBS</b><br>820 | <b>Vesrah</b><br>VD358 |
|------------------------|--------------------------|-------------------|------------------------|

**SUZUKI**

RM 85 LK5/K5/LK6/K6/LK7/K7

05-07 R

**MATERIAL AVAILABILITY AND PART NO.**

| STD     | OPTIONS |        |     |     |
|---------|---------|--------|-----|-----|
| FA      | HH      | R      | MXS | GFA |
| FA401TT | -       | FA401R | -   | -   |

# FA403 41.1 x 44.7 x 6.45mm



**BETA**

REV 3 125/200  
REV 3 250/270

06 R  
05-07 R

**Equivalents OE #**

25 25-363 0 00

**Competitor X Ref**

| MATERIAL AVAILABILITY AND PART NO. |         |   |     |     |
|------------------------------------|---------|---|-----|-----|
| STD                                | OPTIONS |   |     |     |
| FA                                 | HH      | R | MXS | GFA |
| FA403                              | -       | - | -   | -   |

| <u>Dunlop</u> | <u>Ferodo</u> | <u>SBS</u> | <u>Vesrah</u> |
|---------------|---------------|------------|---------------|
| -             | -             | -          | -             |

# MXS405 76.35 x 49.4 x 7.9mm



**APRILIA**

SVX 450/550 Supermotard 06-07 F

**BEHRINGER**

4 Piston radial 05 F

**FTE**

4 Piston Radial Supermoto

**HUSABERG**

FS 450 C 06 F

FS 450 E 06 F

FS 550 E Supermoto 05-07 F

FS 650 C 06-07 F

FS 650 E Supermoto 05-07 F

**KTM**

SMR 450 05-06 F

SMR 525 05

SMR 650 Supermoto 06 F

**Equivalents OE #**

586 13 030 100  
9100906  
1200 S/R2

**Competitor X Ref**

| MATERIAL AVAILABILITY AND PART NO. |         |   |        |          |
|------------------------------------|---------|---|--------|----------|
| STD                                | OPTIONS |   |        |          |
| FA                                 | HH      | R | MXS    | GFA      |
| -                                  | -       | - | MXS405 | GFA405HH |

| <u>Dunlop</u> | <u>Ferodo</u> | <u>SBS</u> | <u>Vesrah</u> |
|---------------|---------------|------------|---------------|
| -             | -             | -          | VD9030        |

# MXS406 102.2 x 47.8 x 7.9mm

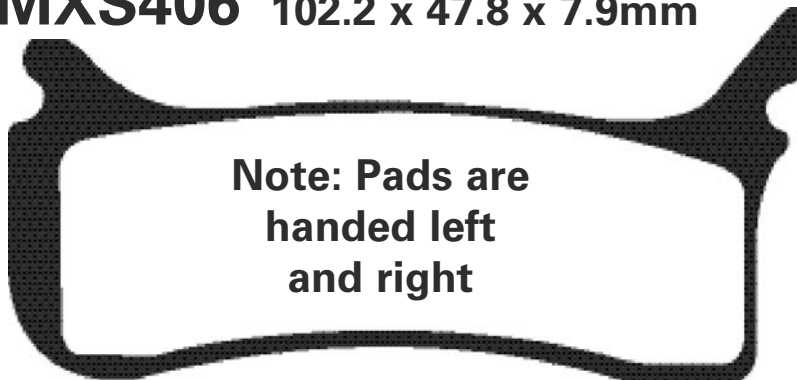

**Equivalents OE #**

800 13 030 000  
1100 S/R2

**BEHRINGER**

6 Piston (Supermoto)

**HUSABERG**

FS Supermotard Models 04- F

**KTM**

SMR 450/525 04 F

**Competitor X Ref**

| MATERIAL AVAILABILITY AND PART NO. |         |   |        |          |
|------------------------------------|---------|---|--------|----------|
| STD                                | OPTIONS |   |        |          |
| FA                                 | HH      | R | MXS    | GFA      |
| -                                  | -       | - | MXS406 | GFA406HH |

| <u>Dunlop</u> | <u>Ferodo</u> | <u>SBS</u> | <u>Vesrah</u> |
|---------------|---------------|------------|---------------|
| -             | -             | -          | -             |

# FA407 100.10 x 57.20 x 8.40mm



INCLUDES CLIP AND RIVET

**BMW**

|              |          |   |
|--------------|----------|---|
| K 100 RS     | 89-92    | F |
| K 1          | 88-93    | F |
| K 1100 LT    | 89-07/93 | F |
| KL 1100 LT   | 89-99    | F |
| K 1100 RS    | 92-96    | F |
| K 1200 RS    | 96-00    | F |
| K 1200 LT    | 97-10/00 | F |
| R 80 Mystic  | 94-95    | F |
| R 80 R       | 91-94    | F |
| R 850 C      | 97-00    | F |
| R 850 GS     | 96-00    | F |
| R 850 R      | 94-02    | F |
| R 850 RT     | 96-01    | F |
| R 100 Mystic | 93-96    | F |
| R 100 R      | 91-95    | F |
| R 1100 GS    | 93-99    | F |
| R 1100 R     | 93-01    | F |
| R 1100 RS    | 92-01    | F |
| R 1100 S     | 96-11/00 | F |
| R 1100 RT    | 94-01    | F |
| R 1150 GS    | 97-11/01 | F |
| R 1200       | 00-02    | F |
| R 1200 C     | 96-02    | F |

**Equivalents OE #**

|                 |                 |                 |
|-----------------|-----------------|-----------------|
| 34 11 2 314 996 | 34 11 7 655 687 | 34 11 7 658 156 |
| 34 11 2 310 983 | 34 11 2 331 173 | 34 11 2 333 045 |
| 34 11 7 663 764 | 34 11 2 314 512 |                 |

**NOTE: THIS PAD REPLACES  
FA246**

**Competitor X Ref**

| Dunlop | Ferodo  | SBS | Vesrah |
|--------|---------|-----|--------|
| DP625  | FDB2050 | 703 | VD959  |

**MATERIAL AVAILABILITY AND PART NO.**

| STD   | OPTIONS |   |     |     |
|-------|---------|---|-----|-----|
| FA    | HH      | R | MXS | GFA |
| FA407 | FA407HH | - | -   | -   |

# FA408 99.84 x 38.52 x 11.8mm

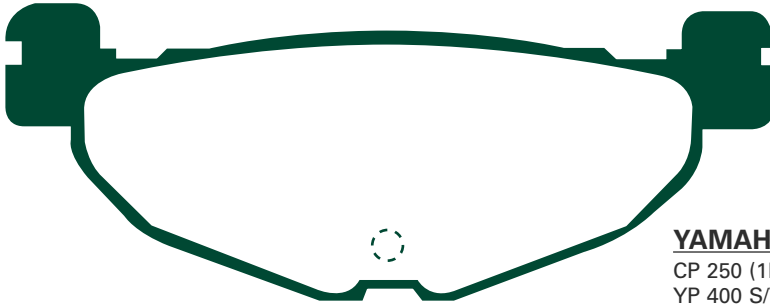

**YAMAHA**

|                             |        |   |
|-----------------------------|--------|---|
| CP 250 (1B71) Maxam         | 05     | R |
| YP 400 S/T Majesty (5RU1/3) | 04     | R |
| YP 400 T/V/W Majesty        | 05-07  | R |
| XP 500 T-Max (5VU1/2)       | 04-07R |   |

**MBK**

|                 |    |   |
|-----------------|----|---|
| YP 400 Skyliner | 04 | R |
|-----------------|----|---|

**Equivalents OE #**

|              |              |
|--------------|--------------|
| 5VU W0046 01 | 1B7 W0046 00 |
|--------------|--------------|

**Competitor X Ref**

| MATERIAL AVAILABILITY AND PART NO. |         |   |     |     |
|------------------------------------|---------|---|-----|-----|
| STD                                | OPTIONS |   |     |     |
| FA                                 | HH      | R | MXS | GFA |
| FA408                              | -       | - | -   | -   |

| Dunlop | Ferodo  | SBS | Vesrah |
|--------|---------|-----|--------|
| -      | FDB2200 | 812 | VD275  |

# FA409HH 91.95 x 56 x 7.05mm

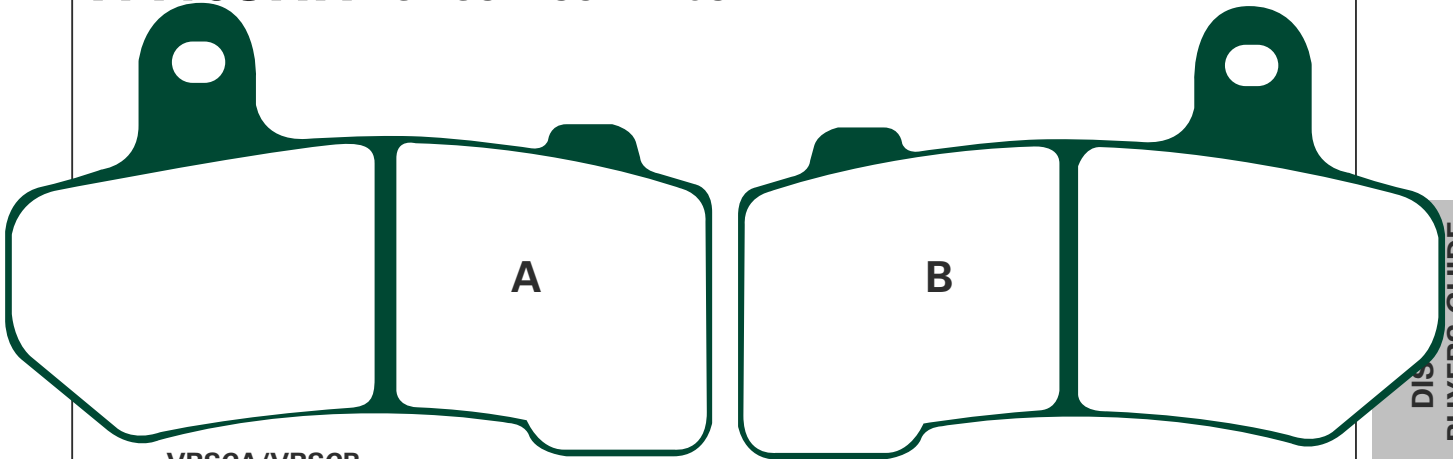

### VRSCA/VRSCB

|                          |       |     |
|--------------------------|-------|-----|
| VRSCR Street Rod         | 05-07 | F&R |
| VRSCD Night Road         | 05-07 | F&R |
| VRSCAW VRod              | 07    | F&R |
| VRSCDX Night Rod Special | 07    | F&R |
| VRSCX VRod               | 07    | F&R |

### Equivalents OE #

42850-06

### Competitor X Ref

| MATERIAL AVAILABILITY AND PART NO. |         |   |     |     |
|------------------------------------|---------|---|-----|-----|
| STD                                | OPTIONS |   |     |     |
| FA                                 | HH      | R | MXS | GFA |
| FA409                              | FA409HH | - | -   | -   |

| Dunlop | Ferodo | SBS | Vesrah |
|--------|--------|-----|--------|
| DP962  | -      | 830 | VD9025 |

# FA410 81.8 x 38.45 x 10.15mm

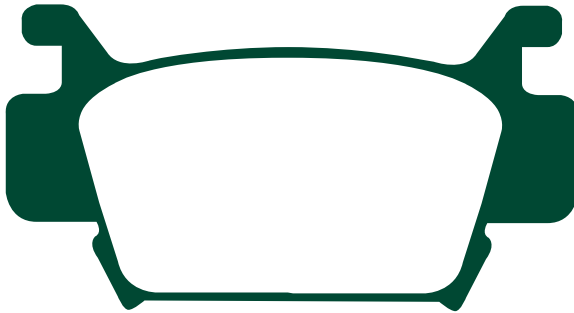

### HONDA

|                                     |       |   |
|-------------------------------------|-------|---|
| TRX 500 FA5/FA6/FA7/FGA5/6/7        | 05-07 | F |
| TRX 680 FGA6/FA6/7 Fourtrack Rincon | 06-07 | F |

### Equivalents OE #

06451 HPO A01  
06452 HPO A01

### Competitor X Ref

| MATERIAL AVAILABILITY AND PART NO. |         |        |     |     |
|------------------------------------|---------|--------|-----|-----|
| STD                                | OPTIONS |        |     |     |
| FA                                 | HH      | R      | MXS | GFA |
| FA410TT                            | -       | FA410R | -   | -   |

| Dunlop | Ferodo | SBS | Vesrah |
|--------|--------|-----|--------|
| 959    | -      | 829 | VD175  |

# FA411 81 x 42 x 8.3mm

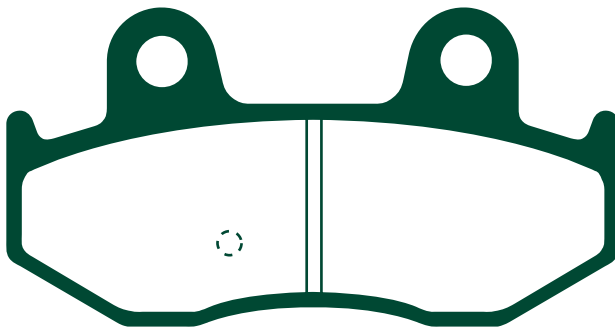

### SUZUKI

|                      |       |   |
|----------------------|-------|---|
| AN 400 K1-K6         | 01-06 | R |
| AN 250 K1/K2 Burgman | 01-02 | R |

### Equivalents OE #

69100 14860  
69100 14890

### Competitor X Ref

| MATERIAL AVAILABILITY AND PART NO. |         |   |     |     |
|------------------------------------|---------|---|-----|-----|
| STD                                | OPTIONS |   |     |     |
| FA                                 | HH      | R | MXS | GFA |
| FA411                              | FA411HH | - | -   | -   |

| Dunlop | Ferodo | SBS | Vesrah |
|--------|--------|-----|--------|
| -      | -      | 781 | VD356  |

# FA412 87.9 x 41.1 x 8.4mm

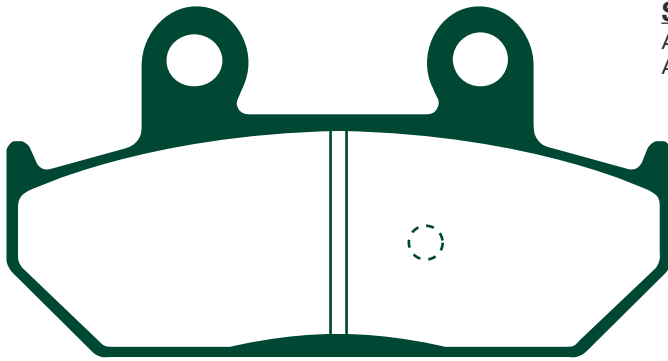

**SUZUKI**

AN 400 K7 Burgman 07 R  
AN 650 K3/K4/AK4/AK5/K5/AK6A/AK7 Burgman 03-07 R

**Equivalents OE #**

|             |
|-------------|
| 69100 10840 |
| 69100 10860 |

**Competitor X Ref**

| MATERIAL AVAILABILITY AND PART NO. |         |   |     |     |
|------------------------------------|---------|---|-----|-----|
| STD                                | OPTIONS |   |     |     |
| FA                                 | HH      | R | MXS | GFA |
| FA412                              | FA412HH | - | -   | -   |

| Dunlop | Ferodo | SBS | Vesrah |
|--------|--------|-----|--------|
| DP968  | -      | 804 | VD357  |

# FA413 A. 82 x 40.85 x 8.22mm B. 62 x 40.8 x 8.6mm

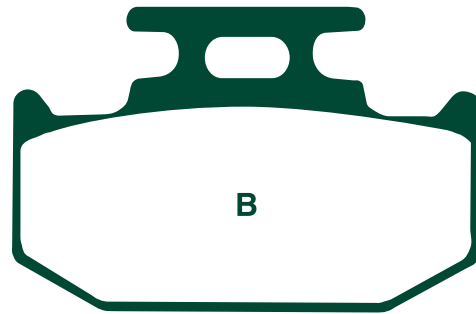
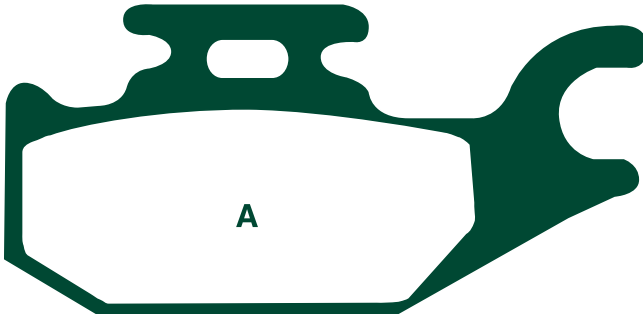

**SUZUKI**

LT-A 450 XK7 07 F(left)  
LT-A 700 XK5/XCK6/XK6/XK7 Kingquad 05-07 F(left)

**Equivalents OE #**

|             |
|-------------|
| 59100 31860 |
|-------------|

**Competitor X Ref**

| MATERIAL AVAILABILITY AND PART NO. |         |        |     |     |
|------------------------------------|---------|--------|-----|-----|
| STD                                | OPTIONS |        |     |     |
| FA                                 | HH      | R      | MXS | GFA |
| FA413TT                            | -       | FA413R | -   | -   |

| Dunlop | Ferodo | SBS | Vesrah  |
|--------|--------|-----|---------|
| DP920  | -      | 835 | VD266/2 |

# FA414 A. 82 x 40.85 x 8.22mm B. 62 x 40.8 x 8.6mm

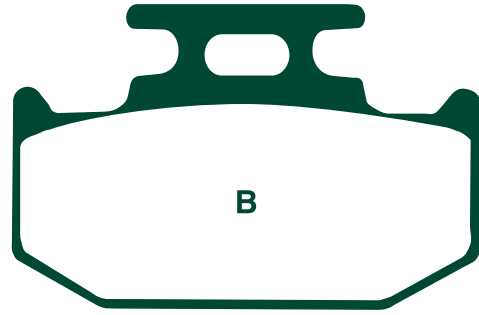
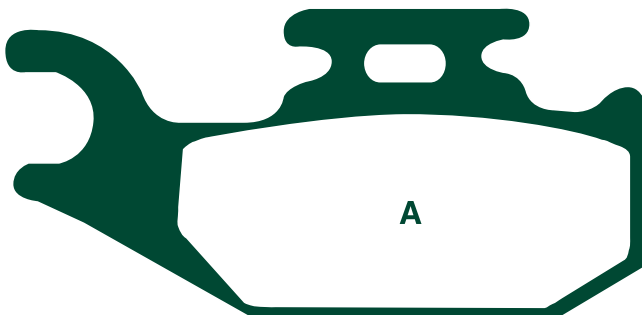

**SUZUKI**

LT-A 450 XK7 07 F(right)  
LT-A 700 XK5/XCK6/XK6/XK7 Kingquad 05-07 F(right)

**Equivalents OE #**

|             |
|-------------|
| 59100 31850 |
|-------------|

**Competitor X Ref**

| MATERIAL AVAILABILITY AND PART NO. |         |        |     |     |
|------------------------------------|---------|--------|-----|-----|
| STD                                | OPTIONS |        |     |     |
| FA                                 | HH      | R      | MXS | GFA |
| FA414TT                            | -       | FA414R | -   | -   |

| Dunlop | Ferodo | SBS | Vesrah  |
|--------|--------|-----|---------|
| DP919  | -      | 836 | VD979/2 |



# FA415 37.35 x 81.7 x 8.95mm - Refit O/E shim

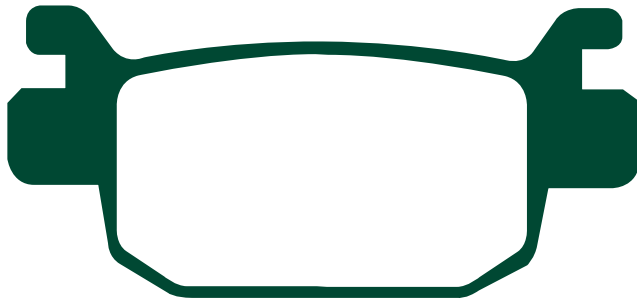

### HONDA

|                               |       |   |
|-------------------------------|-------|---|
| NSS 250 EX5/EX6 Forza EX      | 05-06 | R |
| NSS 250 AX5/AX6 (ABS) Forza Z | 05-06 | R |
| SH 300 i A7                   | 07    | R |

### Equivalents OE #

|               |
|---------------|
| 06435 KSV J01 |
| 06435 KSV J02 |
| 43251 KTW 901 |

### Competitor X Ref

| MATERIAL AVAILABILITY AND PART NO. |         |   |     |     |
|------------------------------------|---------|---|-----|-----|
| STD                                | OPTIONS |   |     |     |
| FA                                 | HH      | R | MXS | GFA |
| FA415                              | FA415HH | - | -   | -   |

| Dunlop | Ferodo | SBS | Vesrah |
|--------|--------|-----|--------|
| -      | -      | 832 | VD173  |

# FA416 A. 85 x 37 x 7.9mm B. 31.8 x 48.1 x 10.2mm



### PGO

|                   |       |   |
|-------------------|-------|---|
| BR 150 E Buggy    | 04-07 | F |
| BR-200 Buggy      | 07    | F |
| BR 250 Buggy E    | 05-07 | F |
| Buggy 50 (Buggie) | 06    | F |

### QUADZILLA

|                    |       |   |
|--------------------|-------|---|
| XRV 250 (Off road) | 06-07 | F |
| XRV 250 E          | 06-07 | F |

### Equivalents OE #

|  |
|--|
|  |
|--|

### Competitor X Ref

| MATERIAL AVAILABILITY AND PART NO. |         |        |     |     |
|------------------------------------|---------|--------|-----|-----|
| STD                                | OPTIONS |        |     |     |
| FA                                 | HH      | R      | MXS | GFA |
| FA416TT                            | -       | FA416R | -   | -   |

| Dunlop | Ferodo | SBS | Vesrah |
|--------|--------|-----|--------|
| -      | -      | -   | -      |

# FA417/4HH 49.85 x 37.75 x 7.78mm

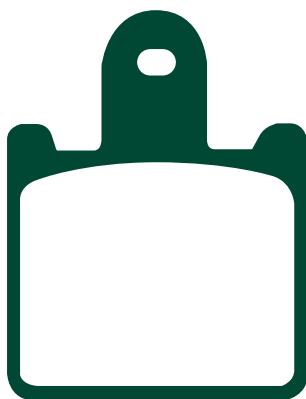

### KAWASAKI

|                            |       |   |
|----------------------------|-------|---|
| ZX6R (ZX 600 P7F)          | 07    | F |
| Z 1000 (ZR 1000 B7F)       | 07    | F |
| Z 1000 ABS (ZR 1000 C7F)   | 07    | F |
| GTR 1400 (ZG 1400 A8F)     | 07    | F |
| ZZR 1400 (ZX 1400 A6F/A7F) | 06-07 | F |
| ZZR 1400 ABS (ZX 1400 B7F) | 07    | F |

### Equivalents OE #

|            |
|------------|
| 43082 0053 |
|------------|

### Competitor X Ref

| MATERIAL AVAILABILITY AND PART NO. |           |   |     |            |
|------------------------------------|-----------|---|-----|------------|
| STD                                | OPTIONS   |   |     |            |
| FA                                 | HH        | R | MXS | GFA        |
| -                                  | FA417/4HH | - | -   | GFA417/4HH |

| Dunlop | Ferodo | SBS | Vesrah |
|--------|--------|-----|--------|
| DP964  | -      | 838 | VD354  |

# FA418 A. 96.8 x 39.35 x 9.3mm B. 77 x 42 x 9.3mm

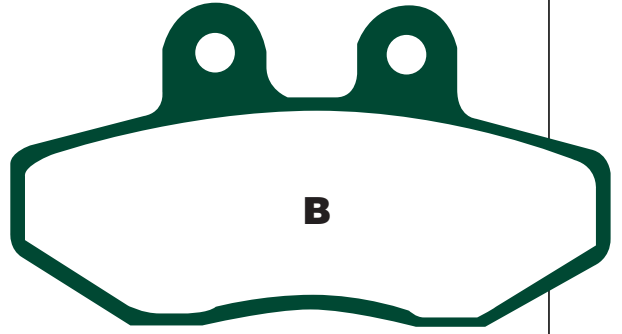
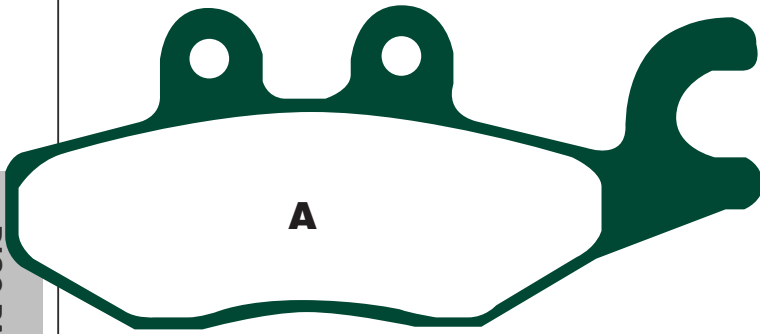

**PIAGGIO**

X9 125 06-07 F(right)  
X9 250 05-06 F(right)

**Equivalents OE #**

|        |
|--------|
| 497395 |
|        |

**Competitor X Ref**

| MATERIAL AVAILABILITY AND PART NO. OPTIONS |    |   |     |     |
|--|----|---|-----|-----|
| STD  | HH | R | MXS | GFA |
| FA   |    |   |     |     |
| FA418                                      | -  | - | -   | -   |

| Dunlop | Ferodo | SBS | Vesrah |
|--------|--------|-----|--------|
| -      | -      | 818 | -      |

# FA419 A. 89.25 x 40.65 x 9.75mm B. 89.25 x 40.65 x 9.75mm

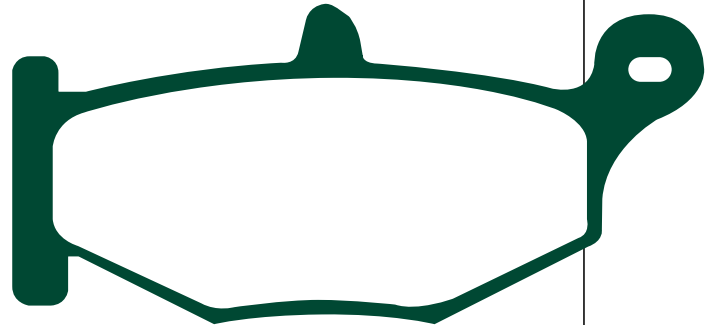
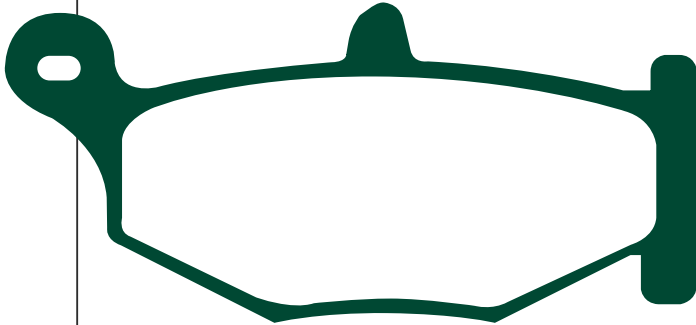

**SUZUKI**

GSR 400 K6 06 R  
GSR 600 K6/AK7 06-07 R  
GSXR 600 K6/K7 06-07 R  
GSXR 750 K6/K7 06-07 R  
GSXR 1000 K7 07 R

**Equivalents OE #**

|             |
|-------------|
| 69101 44810 |
|             |

**Competitor X Ref**

| MATERIAL AVAILABILITY AND PART NO. OPTIONS |         |   |     |     |
|--|---------|---|-----|-----|
| STD  | HH      | R | MXS | GFA |
| FA   |         |   |     |     |
| FA419                                      | FA419HH | - | -   | -   |

| Dunlop | Ferodo | SBS | Vesrah |
|--------|--------|-----|--------|
| DP963  | -      | 833 | SD359  |

# FA420 69.28 x 50.5 x 7.9mm

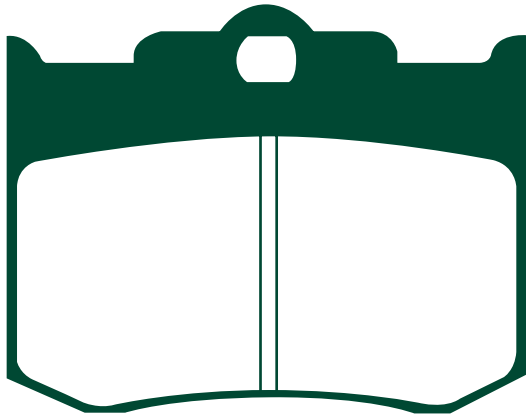

**PERFORMANCE MACHINE**

137X4

06

**Equivalents OE #**

|         |
|---------|
| 137 X 4 |
|---------|

**Competitor X Ref**

| MATERIAL AVAILABILITY AND PART NO. OPTIONS |         |   |     |     |
|--|---------|---|-----|-----|
| STD  | HH      | R | MXS | GFA |
| FA   |         |   |     |     |
| -  | FA420HH | - | -   | -   |

| Dunlop | Ferodo | SBS | Vesrah |
|--------|--------|-----|--------|
| -      | -      | -   | -      |

# FA423/4HH 44.7 x 53.5 x 8.45mm

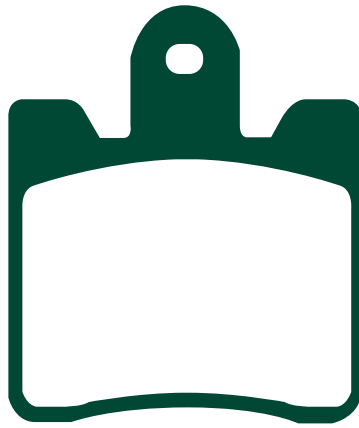

## YAMAHA

FJR 1300 AV/ASV (ABS) (3P61/2/3)  
FJR 1300 AS (2D21)

06-07 F  
06-07 F

### Equivalents OE #

3P6 W0045 00

### Competitor X Ref

| MATERIAL AVAILABILITY AND PART NO. |           |   |     |     |
|------------------------------------|-----------|---|-----|-----|
| STD                                | OPTIONS   |   |     |     |
| FA                                 | HH        | R | MXS | GFA |
| -                                  | FA423/4HH | - | -   | -   |

| Dunlop | Ferodo | SBS | Vesrah |
|--------|--------|-----|--------|
| DP965  | -      | 740 | VD353  |

# FA424 91.6 x 39.1 x 8.2mm

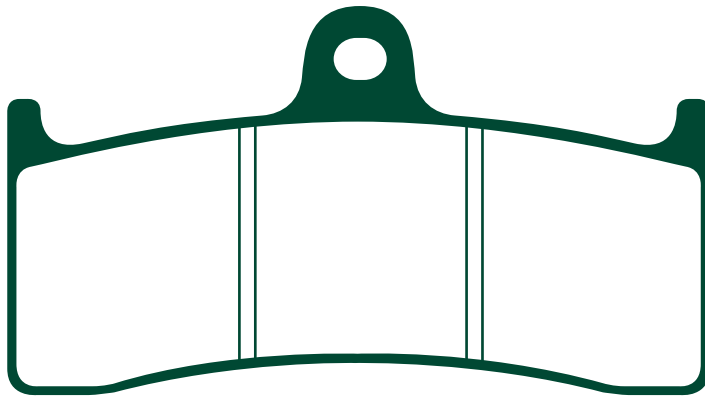

## HONDA

CB 1300 FW/FX/FY (SC40)

98-00 F

## KAWASAKI

ZX-7RR (ZX750 N1/N2)

96-99 F

## YAMAHA

YZF-R7 750 '0W02' (Race version)

99-01 F

## M.V. AGUSTA (Nissin Calipers)

F4 750

99-03 F

Brutale 750 S

03-06 F

F4 1000

04-06 F

Brutale 910 S

05-07 F

Brutale 910 Standard

05-07 F

## MONDIAL

Piega 1000

02 F

## BUELL

X1 Lightning

99-02 F

M2 Cyclone

98-02 F

S1 Lightning

98-00 F

S1 Whitelighting

98-00 F

S3 Thunderbolt

98-00 F

S3T Thunderbolt

98-00 F

### Equivalents OE #

43082 1181

800094024

### Competitor X Ref

| MATERIAL AVAILABILITY AND PART NO. |         |   |     |            |
|------------------------------------|---------|---|-----|------------|
| STD                                | OPTIONS |   |     |            |
| FA                                 | HH      | R | MXS | GFA        |
| FA424                              | FA424HH | - | -   | GFA424HHLC |

| Dunlop | Ferodo | SBS | Vesrah |
|--------|--------|-----|--------|
| -      | -      | -   | -      |

# FA425 55.5 x 54.5 x 8mm

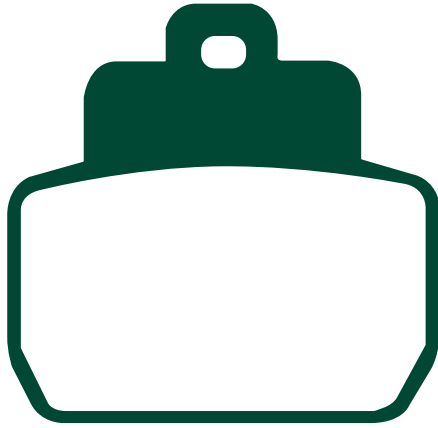

**GILERA**

|                         |       |   |
|-------------------------|-------|---|
| Fuoco 500 ie            | 07    | R |
| <b>PIAGGIO</b>          |       |   |
| MP3 125 (All models)    | 06-07 | R |
| X8 125                  | 05-06 | R |
| X8 125 ie               | 07    | R |
| X8 125/Street           | 07    | R |
| X9 125                  | 06    | R |
| X8 150 Street           | 07    | R |
| MP3 250 ie (All models) | 06-07 | R |
| X8 250 ie               | 05-07 | R |
| X9 250                  | 05-07 | R |
| MP3 400 ie (All models) | 07    | R |
| X8 400 ie               | 07    | R |
| Beverly 500             | 06    | R |

**Equivalents OE #**

|        |
|--------|
| 497429 |
| 647080 |
| 647400 |

**Competitor X Ref**

| MATERIAL AVAILABILITY AND PART NO. |         |   |     |     |
|------------------------------------|---------|---|-----|-----|
| STD                                | OPTIONS |   |     |     |
| FA                                 | HH      | R | MXS | GFA |
| FA425                              | -       | - | -   | -   |

| Dunlop | Ferodo | SBS | Vesrah |
|--------|--------|-----|--------|
| -      | -      | 831 | -      |

# FA426 64 x 48 x 7.8mm

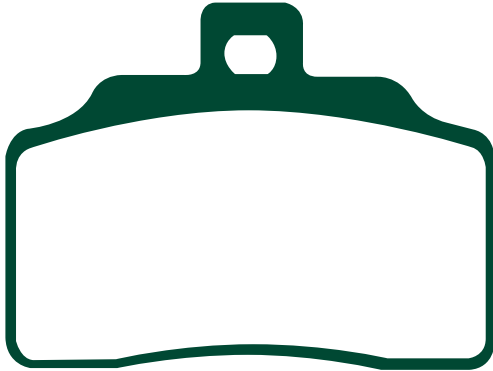

**BETA**

|                    |       |   |
|--------------------|-------|---|
| M4 350 Supermotard | 04-07 | F |
|--------------------|-------|---|

**Equivalents OE #**

|           |
|-----------|
| 252524600 |
|-----------|

**Competitor X Ref**

| MATERIAL AVAILABILITY AND PART NO. |         |   |     |     |
|------------------------------------|---------|---|-----|-----|
| STD                                | OPTIONS |   |     |     |
| FA                                 | HH      | R | MXS | GFA |
| FA426                              | -       | - | -   | -   |

| Dunlop | Ferodo | SBS | Vesrah |
|--------|--------|-----|--------|
| -      | -      | -   | -      |

# FA427 94 x 36.1 x 10.3mm

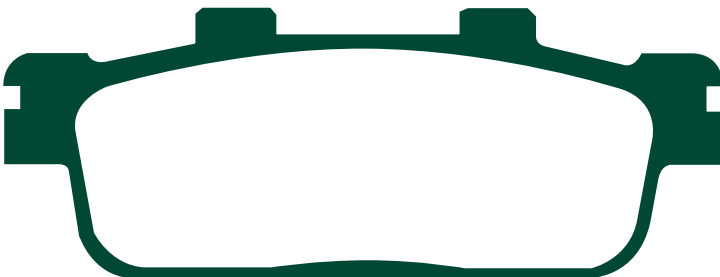

**CPI**

|                    |       |   |
|--------------------|-------|---|
| ST 250 Sector Quad | 05-06 | R |
|--------------------|-------|---|

**E-TON**

|                      |       |   |
|----------------------|-------|---|
| RXL 150 Vector       | 07    | R |
| VXL 250 ST Vector    | 06-07 | R |
| VXL 250 Vector       | 06-07 | R |
| VXL 300 Vector       | 07    | R |
| VXL 300 ST Vector ST | 07    | R |
| VTX 300 Vortex       | 07    | R |
| VTX 300 ST Vortex ST | 07    | R |

**SYM**

|                      |       |     |
|----------------------|-------|-----|
| HD 200 S Evo         | 07    | R   |
| GTS 250 Joymax       | 07    | R   |
| Trackrunner 200 Quad | 05-07 | R   |
| Quadlander 250       | 05-07 | R   |
| GTS 125/200 Voyager  | 06-07 | F&R |
| H200SE               | 06    | R   |
| Joymax 250 GTS       | 06-07 | R   |
| Citymax 300 Quad     | 06    | R   |

**Equivalents OE #**

|                |
|----------------|
| G7131 LRAO 000 |
| 812111         |

**Competitor X Ref**

| MATERIAL AVAILABILITY AND PART NO. |         |        |     |     |
|------------------------------------|---------|--------|-----|-----|
| STD                                | OPTIONS |        |     |     |
| FA                                 | HH      | R      | MXS | GFA |
| FA427                              | -       | FA427R | -   | -   |

| Dunlop | Ferodo | SBS | Vesrah |
|--------|--------|-----|--------|
| -      | -      | -   | -      |

# FA428 A. 82.08 x 40.85 x 9.5mm B. 62.03 x 40.8 x 9.5mm

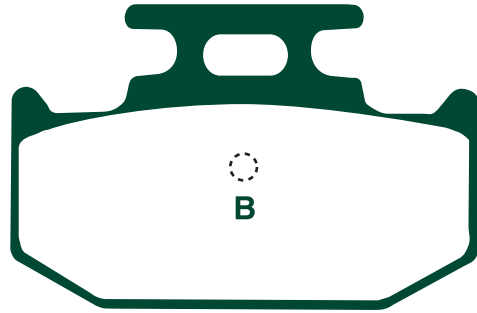
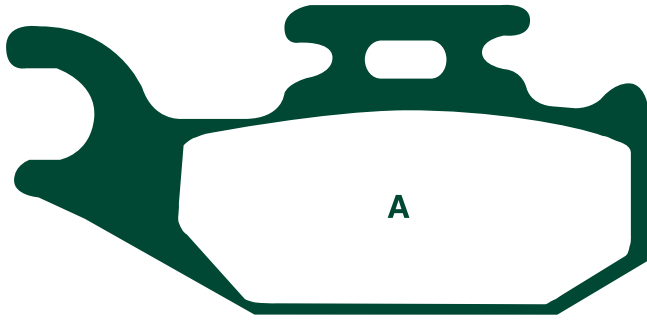

**YAMAHA**

YXR 66 FAS/FAT/FAV Rhino 4x4 Side x Side  
YFM 700 RV/RW Raptor

04-06 R  
06-07 R

**Equivalents OE #**

1S3 W0046 00  
5UG W0046 00

| MATERIAL AVAILABILITY AND PART NO. |         |        |     |     |
|------------------------------------|---------|--------|-----|-----|
| STD                                | OPTIONS |        |     |     |
| FA                                 | HH      | R      | MXS | GFA |
| FA428TT                            | -       | FA428R | -   | -   |

**Competitor X Ref**

| Dunlop | Ferodo | SBS | Vesrah |
|--------|--------|-----|--------|
| -      | -      | 816 | VD276  |

# FA430 A. 94.5 x 40 x 7.5mm B. 94.5 x 40 x 7.5mm

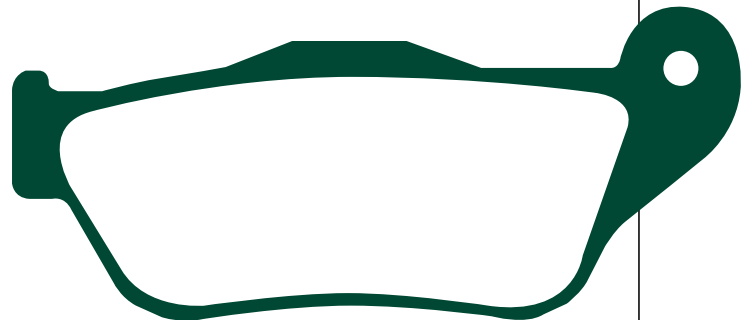
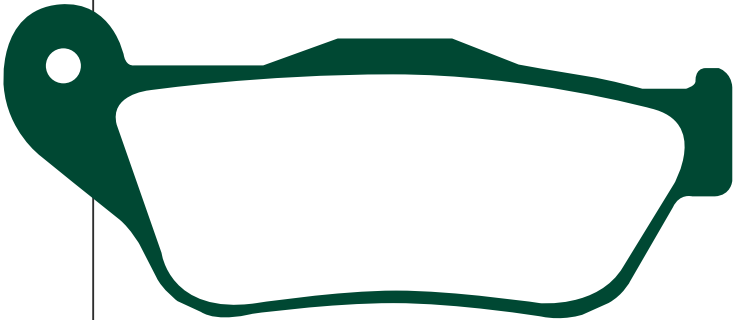

**YAMAHA**

YP 125 X-Max  
YP 250 (X-Max)

06-07 F  
05-07 F

**Equivalents OE #**

1B9 W0045 00

| MATERIAL AVAILABILITY AND PART NO. |         |   |     |     |
|------------------------------------|---------|---|-----|-----|
| STD                                | OPTIONS |   |     |     |
| FA                                 | HH      | R | MXS | GFA |
| FA430                              | -       | - | -   | -   |

**Competitor X Ref**

| Dunlop | Ferodo | SBS | Vesrah |
|--------|--------|-----|--------|
| -      | -      | 837 | -      |

# FA431TT A. 103.5 x 42.6 x 9mm B. 62.95 x 34.5 x 5.4mm

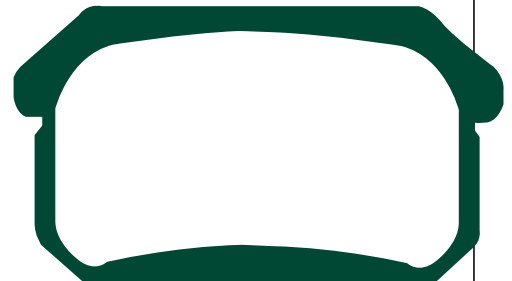

**CPI**

XS 250 Power Quad

07 R

**QUADZILLA**

XRV 250 (Off road)

06-07 R

XRV 250 E

06-07 R

**PGO**

BR-200 Bugdrider

07 R

250 E Bugdrider

05-07 R

**Equivalents OE #**

|  |
|--|
|  |
|  |

**Competitor X Ref**

| MATERIAL AVAILABILITY AND PART NO. |         |        |     |     |
|------------------------------------|---------|--------|-----|-----|
| STD                                | OPTIONS |        |     |     |
| FA                                 | HH      | R      | MXS | GFA |
| FA431TT                            | -       | FA431R | -   | -   |

| Dunlop | Ferodo | SBS | Vesrah |
|--------|--------|-----|--------|
| -      | -      | -   | -      |

# FA432 68 x 55 x 9mm



**APRILIA**

RS 125 (Radial Caliper)  
 SL 750 Shiver  
 NS 850 Mana

06 F  
 07 F  
 07 F

**Equivalents OE #**

8133943

**Competitor X Ref**

| MATERIAL AVAILABILITY AND PART NO. |         |   |     |     |
|------------------------------------|---------|---|-----|-----|
| STD                                | OPTIONS |   |     |     |
| FA                                 | HH      | R | MXS | GFA |
| FA432                              | FA432HH | - | -   | -   |

| Dunlop | Ferodo | SBS | Vesrah |
|--------|--------|-----|--------|
| -      | -      | 844 | -      |

# FA433/4HH

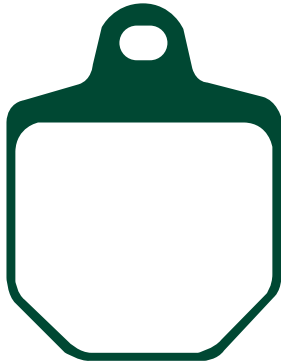

**APRILIA**

MXV 450 Magura Calipers

07 F

**HONDA HM (Italy)**

CRM 125 R Supermoto  
 CRM 250 X Supermoto  
 CRM 450 R/X Supermoto  
 CRM F 490 X Supermoto

07 F  
 07 F  
 07 F  
 07 F

**KTM**

SMR 450  
 SMR 560

07 F  
 07 F

**MAGURA**

4 piston radial supermoto caliper

**Equivalents OE #**

0722189  
 072223

SINTERED  
 CARBON

**Competitor X Ref**

| MATERIAL AVAILABILITY AND PART NO. |           |   |     |     |
|------------------------------------|-----------|---|-----|-----|
| STD                                | OPTIONS   |   |     |     |
| FA                                 | HH        | R | MXS | GFA |
| FA433/4                            | FA433/4HH | - | -   | -   |

| Dunlop | Ferodo | SBS | Vesrah |
|--------|--------|-----|--------|
| -      | -      | 843 | -      |

# FA434HH A. 97.54 x 64.2 x 8mm B. 97.54 x 64.2 x 8mm



**NOTE:  
DOUBLE CHECK PAD  
SHAPE. DO NOT  
CONFUSE WITH FA400.**

DISC PADS  
BUYERS GUIDE

**HARLEY DAVIDSON**

|  |       |   |
|--|-------|---|
| FXST/FXSTi/FXSTS/FXSTS <i>i</i> Softail Standard | 06-07 | R |
| FXSTB/FXSTBi Night Train                         | 06-07 | R |
| FLSTSC/FLSTSC <i>i</i> Springer Softail          | 06-07 | R |
| FXSTS/FXSTS <i>i</i> Springer Softail            | 06    | R |

**Equivalents OE #**

|          |
|----------|
| 46721-06 |
|----------|

**Competitor X Ref**

| MATERIAL AVAILABILITY AND PART NO. |         |   |     |     |
|------------------------------------|---------|---|-----|-----|
| STD                                | OPTIONS |   |     |     |
| FA                                 | HH      | R | MXS | GFA |
| FA434                              | FA434HH | - | -   | -   |

| Dunlop | Ferodo | SBS | Vesrah |
|--------|--------|-----|--------|
| DP971  | -      | -   | -      |

# GFA435/4HHLC 43.5 x 49 x 9.5mm

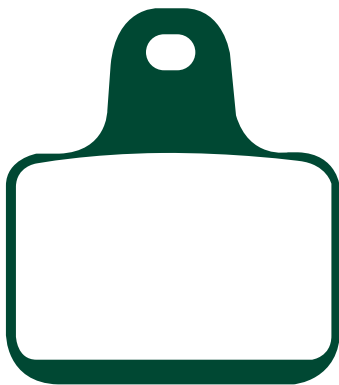

**BREMBO**

X 99.04 Raidal mount caliper 4 piston/4 pad  
**PVM**  
 4 Piston Radial Mount Caliper F

**Equivalents OE #**

|            |
|------------|
| 07 7874 24 |
|------------|

**Competitor X Ref**

| MATERIAL AVAILABILITY AND PART NO. |         |   |     |            |
|------------------------------------|---------|---|-----|------------|
| STD                                | OPTIONS |   |     |            |
| FA                                 | HH      | R | MXS | GFA        |
| -                                  | -       | - | -   | GFA435HHLC |

| Dunlop | Ferodo | SBS | Vesrah |
|--------|--------|-----|--------|
| -      | -      | 805 | -      |

# FA436 77.5 x 42.5 x 8.8mm

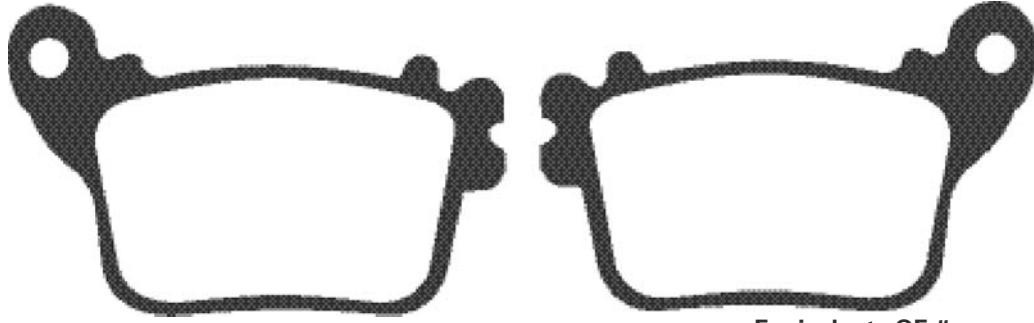

**HONDA**

CB 600 F7 Hornet  
CBR 600 RR7  
CBR 1000 RR6/RR7

07 R  
07 R  
06-07 R

**Equivalents OE #**

|               |
|---------------|
| 06435 MEL D21 |
| 06435 MFG D02 |

**Competitor X Ref**

| MATERIAL AVAILABILITY AND PART NO. |         |   |     |     |
|------------------------------------|---------|---|-----|-----|
| STD                                | OPTIONS |   |     |     |
| FA                                 | HH      | R | MXS | GFA |
| FA436                              | FA436HH | - | -   | -   |

| Dunlop | Ferodo | SBS | Vesrah |
|--------|--------|-----|--------|
| DP973  | -      | 834 | -      |

# FA438HH A. 102.9 x 37.3 x 8.52mm B. 102.9 x 37.3 x 8.45mm

**NOTE: Need to order new wear lead Part no. MWL002**

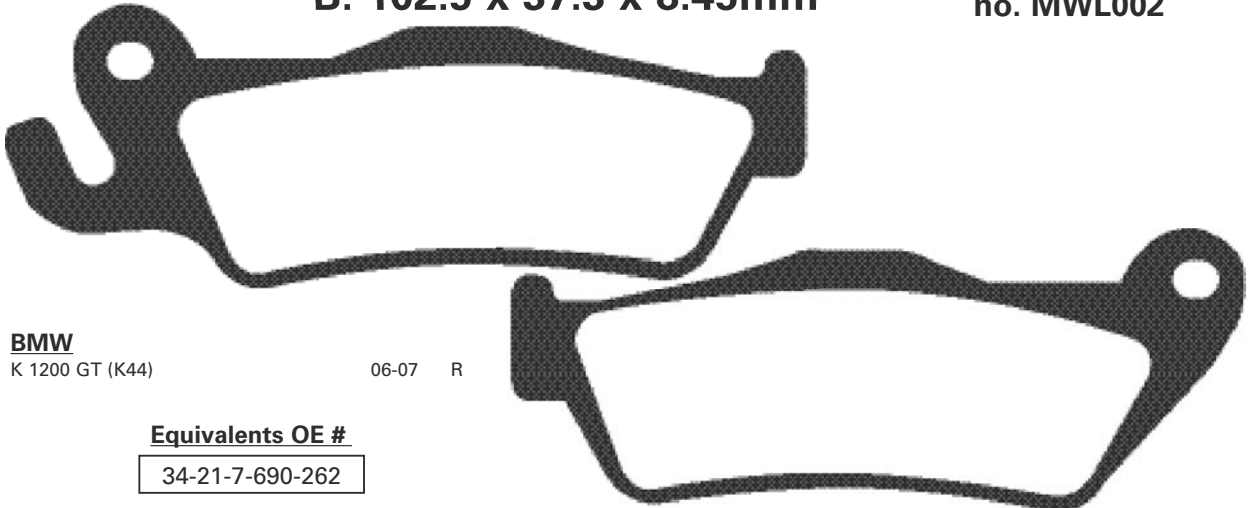

**BMW**

K 1200 GT (K44)

06-07 R

**Equivalents OE #**

|                 |
|-----------------|
| 34-21-7-690-262 |
|-----------------|

**Competitor X Ref**

| MATERIAL AVAILABILITY AND PART NO. |         |   |     |     |
|------------------------------------|---------|---|-----|-----|
| STD                                | OPTIONS |   |     |     |
| FA                                 | HH      | R | MXS | GFA |
| -                                  | FA438HH | - | -   | -   |

| Dunlop | Ferodo | SBS | Vesrah |
|--------|--------|-----|--------|
| -      | -      | -   | -      |

# FA441HH A. 77.3 x 51.45 x 8.55mm B. 77.3 x 51.45 x 8.55mm

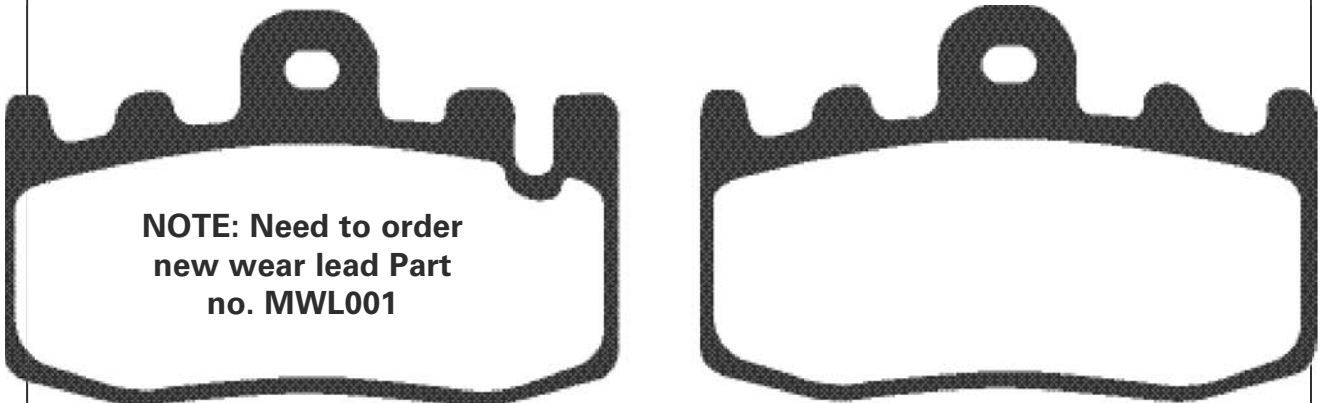

**NOTE: Need to order new wear lead Part no. MWL001**

**Equivalents OE #**

|                 |
|-----------------|
| 34-22-7-690-259 |
|-----------------|

**BMW**

K 1200 GT (K44)

06-07 F(right)

**Competitor X Ref**

| MATERIAL AVAILABILITY AND PART NO. |         |   |     |     |
|------------------------------------|---------|---|-----|-----|
| STD                                | OPTIONS |   |     |     |
| FA                                 | HH      | R | MXS | GFA |
| -                                  | FA441HH | - | -   | -   |

| Dunlop | Ferodo | SBS | Vesrah |
|--------|--------|-----|--------|
| -      | -      | -   | -      |



# FA442/4HH A. 61.85 x 44.25 x 8.1mm B. 48 x 30.8 x 8.1mm

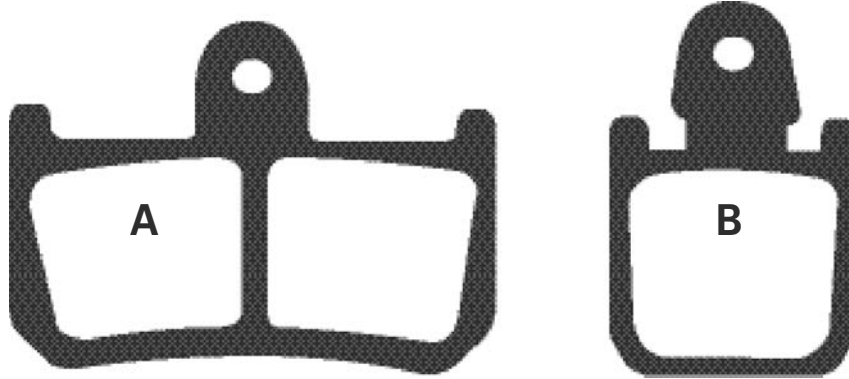

**Equivalents OE #**  
 4C8 W0045 00

**YAMAHA**  
 YZF R1 (6 piston radial caliper)  
 MT-01 (6 piston radial caliper)

07 F  
 07 F

**Competitor X Ref**

| MATERIAL AVAILABILITY AND PART NO. |           |   |     |            |
|------------------------------------|-----------|---|-----|------------|
| STD                                | OPTIONS   |   |     |            |
| FA                                 | HH        | R | MXS | GFA        |
| FA442/4                            | FA442/4HH | - | -   | GFA442/4HH |

| Dunlop | Ferodo | SBS | Vesrah |
|--------|--------|-----|--------|
| DP977  | -      | 839 | -      |

# FA443TT A. 107 x 33.75 x 8mm B. 91.66 x 38.2 x 8mm

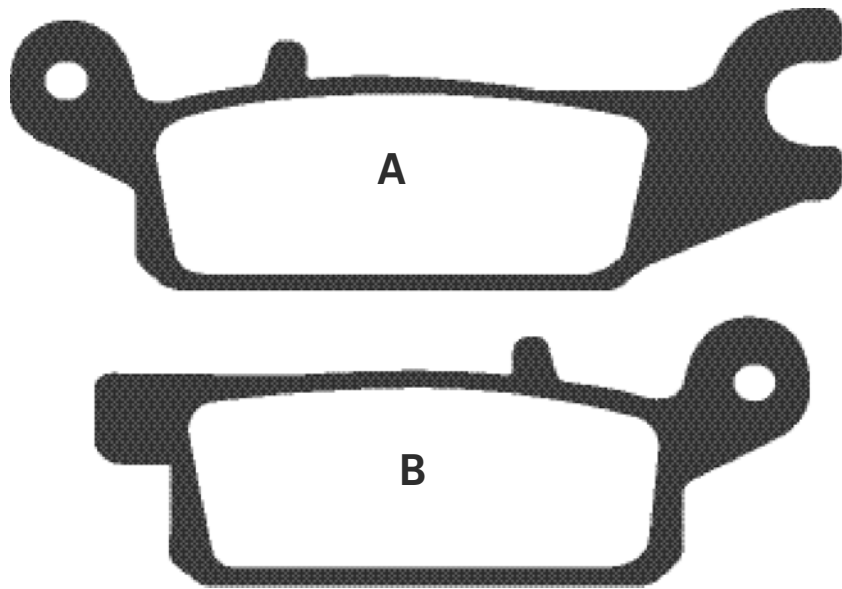

**YAMAHA**  
 YFM 700 FGPW Grizzly

07 F(left)

**Equivalents OE #**  
 3B4 W0045 00

**Competitor X Ref**

| MATERIAL AVAILABILITY AND PART NO. |         |        |     |     |
|------------------------------------|---------|--------|-----|-----|
| STD                                | OPTIONS |        |     |     |
| FA                                 | HH      | R      | MXS | GFA |
| FA443TT                            | -       | FA443R | -   | -   |

| Dunlop | Ferodo | SBS | Vesrah |
|--------|--------|-----|--------|
| DP979  | -      | -   | -      |

# FA444TT A. 107 x 33.75 x 8mm B. 91.66 x 38.2 x 8mm

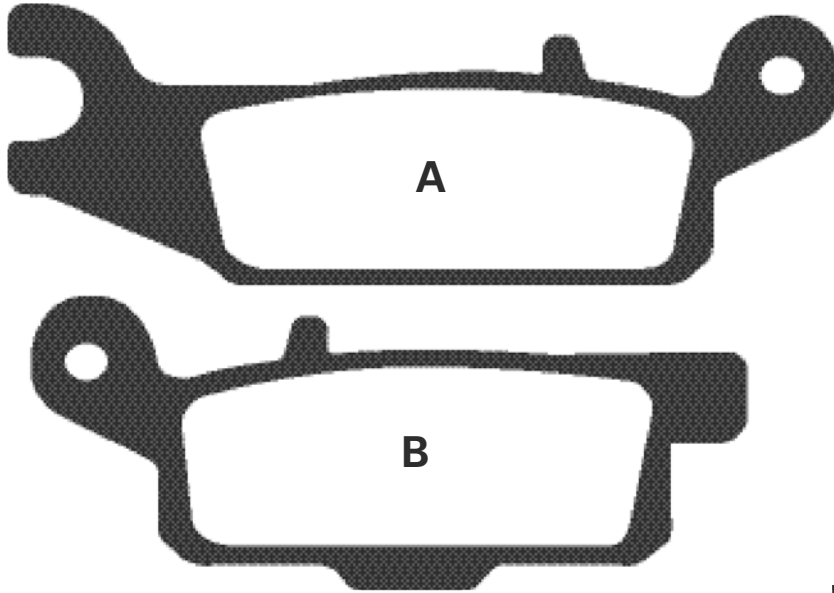

**Equivalents OE #**

3B4 W0045 10

**YAMAHA**

YFM 700 FGPW Grizzly

07 F(right)

**Competitor X Ref**

| MATERIAL AVAILABILITY AND PART NO. |         |        |     |     |
|------------------------------------|---------|--------|-----|-----|
| STD                                | OPTIONS |        |     |     |
| FA                                 | HH      | R      | MXS | GFA |
| FA444TT                            | -       | FA444R | -   | -   |

| Dunlop | Ferodo | SBS | Vesrah |
|--------|--------|-----|--------|
| DP980  | -      | -   | -      |

# FA445TT A. 107 x 33.75 x 8mm B. 91.66 x 38.2 x 8mm

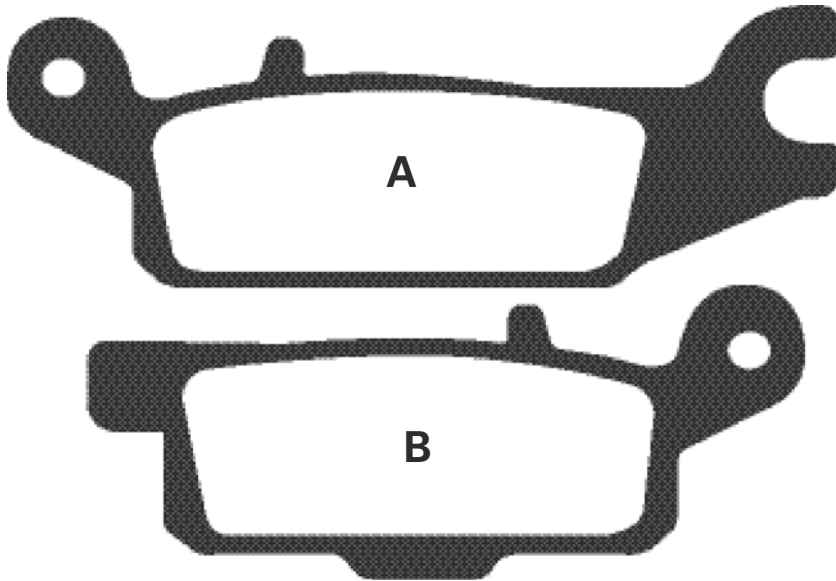

**Equivalents OE #**

3B4 W0046 00

**YAMAHA**

YFM 700 FGPW Grizzly

07 R(left)

**Competitor X Ref**

| MATERIAL AVAILABILITY AND PART NO. |         |        |     |     |
|------------------------------------|---------|--------|-----|-----|
| STD                                | OPTIONS |        |     |     |
| FA                                 | HH      | R      | MXS | GFA |
| FA445TT                            | -       | FA445R | -   | -   |

| Dunlop | Ferodo | SBS | Vesrah |
|--------|--------|-----|--------|
| DP981  | -      | -   | -      |

# FA446TT A. 107 x 33.75 x 8mm B. 91.66 x 38.2 x 8mm

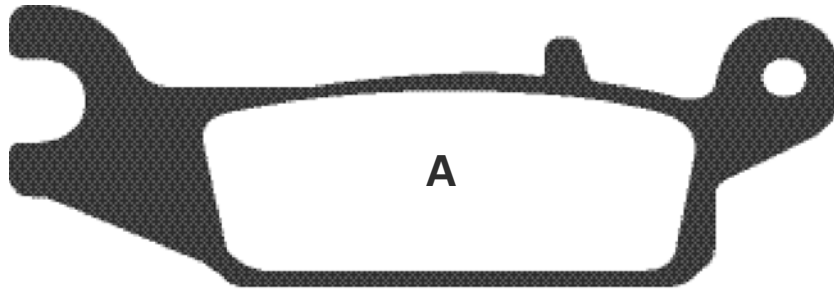

A

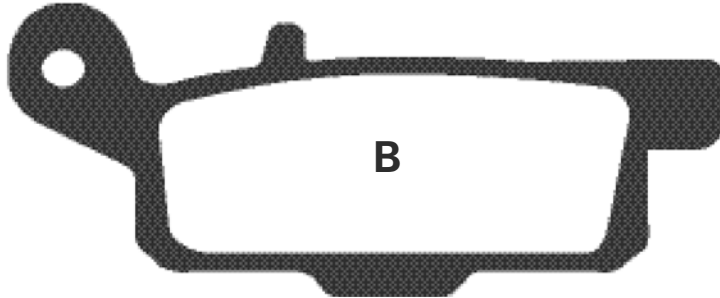

B

**Equivalents OE #**

3B4 W0046 10

**YAMAHA**

YFM 700 FGPW Grizzly

07 R(right)

**Competitor X Ref**

| MATERIAL AVAILABILITY AND PART NO. |         |        |     |     |
|------------------------------------|---------|--------|-----|-----|
| STD                                | OPTIONS |        |     |     |
| FA                                 | HH      | R      | MXS | GFA |
| FA446TT                            | -       | FA446R | -   | -   |

| Dunlop | Ferodo | SBS | Vesrah |
|--------|--------|-----|--------|
| DP982  | -      | -   | -      |

# FA447HH 102.25 x 42.25 x 7.5mm

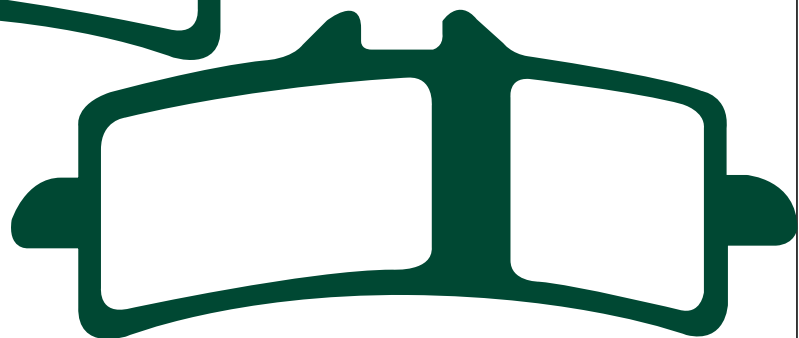

**BREMBO**

Monobloc M4 Radial Mount (1 pc pad)

**DUCATI**

Desmosedici RR (D16RR) (989cc)

1098

1098 S

1098 Tricolore

Hypermotard

**MV AGUSTA**

F4 1000 CC

07 F  
07 F  
07 F  
07 F  
07 F  
07 F

**Equivalents OE #**

61340791A  
07 9882 10

**Competitor X Ref**

| MATERIAL AVAILABILITY AND PART NO. |         |   |     |          |
|------------------------------------|---------|---|-----|----------|
| STD                                | OPTIONS |   |     |          |
| FA                                 | HH      | R | MXS | GFA      |
| -                                  | FA447HH | - | -   | GFA447HH |

| Dunlop | Ferodo | SBS | Vesrah |
|--------|--------|-----|--------|
| DP978  | -      | 841 | -      |

# FA448 58.1 x 33.35 x 6mm



**ELSTARS (PIT BIKES)**

Various models (Check parts before fitting)

F&R

**ITALJET**

Pit Jet 125 4T

07

F&R

**Equivalents OE #**

**Competitor X Ref**

| MATERIAL AVAILABILITY AND PART NO. |         |   |     |     |
|------------------------------------|---------|---|-----|-----|
| STD                                | OPTIONS |   |     |     |
| FA                                 | HH      | R | MXS | GFA |
| FA448                              | -       | - | -   | -   |

| Dunlop | Ferodo | SBS | Vesrah |
|--------|--------|-----|--------|
| -      | -      | -   | -      |

# FA450TT 94.2 x 31.8 x 7.2mm



**YAMAHA**

YZ 250 FW

07 F

**Equivalents OE #**

5XC W0045 00

**Competitor X Ref**

| MATERIAL AVAILABILITY AND PART NO. |         |        |        |     |
|------------------------------------|---------|--------|--------|-----|
| STD                                | OPTIONS |        |        |     |
| FA                                 | HH      | R      | MXS    | GFA |
| FA450TT                            | -       | FA450R | MXS450 | -   |

| Dunlop | Ferodo | SBS | Vesrah |
|--------|--------|-----|--------|
| DP983  | -      | 840 | -      |

# DISC BRAKE PAD COMPETITOR INTERCHANGE LIST

| BREMBO   | EBC          | BREMBO   | EBC     | BREMBO    | EBC      | BREMBO   | EBC     |
|----------|--------------|----------|---------|-----------|----------|----------|---------|
| 07BB0106 | FA47         | 07BB24SA | FA407HH | 07HD16SA  | FA400HH  | 07HO31SP | FA196HH |
| 07BB0109 | FA47/3       | 07BB2507 | FA304   | 07HD16SP  | FA400HH  | 07HO3405 | FA196   |
| 07BB0110 | FA47         | 07BB2607 | FA335HH | 07HO0130  | FA13     | 07HO34SP | FA196HH |
| 07BB0111 | FA47         | 07BB26SA | FA335HH | 07HO0229  | FA12     | 07HO3509 | FA124   |
| 07BB01SP | FA47HH       | 07BB2750 | FA368   | 07HO0307  | FA30     | 07HO35SA | FA124HH |
| 07BB0210 | FA208/213    | 07BB27SD | FA368R  | 07HO0411  | FA32     | 07HO3607 | FA174   |
| 07BB0250 | FA208R/213HH | 07BB27SX | FA368R  | 07HO0531  | FA43     | 07HO36SP | FA174HH |
| 07BB-2SD | FA208/213    | 07GR0101 | FA50    | 07HO0631  | FA40     | 07HO3907 | FA189   |
| 07BB02SX | FA208R/213HH | 07GR0204 | FA76    | 07HO0712  | FA45     | 07HO39SA | FA189HH |
| 07BB02TT | FA208/213    | 07GR1001 | FA98    | 07HO0831  | FA52     | 07HO39SP | FA189HH |
| 07BB0306 | FA209/2      | 07GR1406 | FA167   | 07HO0906  | FA54     | 07HO4008 | FA197   |
| 07BB0310 | FA209/2      | 07GR1506 | FA166   | 07HO09SD  | FA54HH   | 07HO4108 | FA196   |
| 07BB0311 | FA209/2      | 07GR1705 | FA156   | 07HO09SX  | FA54R    | 07HO41SA | FA196HH |
| 07BB0350 | FA209/2HH    | 07GR2106 | FA177   | 07HO09TT  | FA54TT   | 07HO4206 | FA281   |
| 07BB03SA | FA209/2HH    | 07GR35SP | FA320HH | 07HO1010  | FA69/3   | 07HO42SA | FA261HH |
| 07BB0410 | FA181        | 07GR4804 | FA351   | 07HO10SA  | FA69/3HH | 07HO4308 | FA281   |
| 07BB0450 | FA181HH/R    | 07GR49SD | FA307TT | 07HO10SP  | FA69/3HH | 07HO43SA | FA261HH |
| 07BB04SA | FA245HH      | 07GR49SX | FA307R  | 07HO1118  | FA83     | 07HO43SP | FA261HH |
| 07BB04SD | FA245HH      | 07GR50SD | FA317TT | 07HO1212  | FA29     | 07HO4507 | FA296HH |
| 07BB04SP | FA363HH      | 07GR50SX | FA317R  | 07HO1406  | FA80     | 07HO45RC | FA296HH |
| 07BB04SX | FA245HH      | 07GR5105 | FA291   | 07HO1505  | FA92TT   | 07HO45SA | FA296HH |
| 07BB04TT | FA245        | 07GR5209 | FA377   | 07HO15SD  | FA92R    | 07HO45SC | FA296HH |
| 07BB0510 | FA322/4HH    | 07GR52SD | FA377R  | 07HO15SX  | FA92R    | 07HO4607 | FA153   |
| 07BB05RC | FA322/4HH    | 07GR52SX | FA377R  | 07HO15TT  | FA92TT   | 07HO48SD | FA346R  |
| 07BB05SA | FA322/4HH    | 07GR53SD | FA395R  | 07HO1609  | FA90     | 07HO48SX | FA346R  |
| 07BB05SC | FA322/4HH    | 07GR54SD | FA271R  | 07HO1708  | FA80/2   | 07HO48TT | FA346TT |
| 07BB0606 | FA120        | 07GR54SX | FA271R  | 07HO1807  | FA69/2   | 07HO4905 | FA343   |
| 07BB0708 | FA251        | 07GR55SD | N/A     | 07HO018SP | N/A      | 07HO50RC | FA390HH |
| 07BB0810 | FA268        | 07GR5605 | FA126   | 07HO1912  | FA109    | 07HO50SA | FA390HH |
| 07BB0907 | FA134        | 07GR56SC | FA126HH | 07HO20SD  | FA84/3R  | 07HO50SC | FA390HH |
| 07BB1205 | FA115        | 07GR5705 | FA164   | 07HO20TT  | FA84TT   | 07HO55SD | FA373R  |
| 07BB12TT | FA115        | 07GR5804 | FA303   | 07HO2107  | FA121    | 07HO5606 | FA375   |
| 07BB1305 | FA60         | 07GR5915 | FA22    | 07HO21SA  | FA121HH  | 07HO57SA | FA388HH |
| 07BB1310 | FA60         | 07GR6007 | FA57    | 07HO21SC  | FA121HH  | 07HO58SD | FA410R  |
| 07BB13SD | FA337R       | 07GR6207 | FA188   | 07HO2205  | FA84/3TT | 07KA0122 | FA73    |
| 07BB1408 | FA18         | 07GR62SA | FA188HH | 07HO22SD  | FA84/3R  | 07KA0223 | FA55    |
| 07BB1410 | FA18         | 07GR6319 | FA56    | 07HO22SX  | FA84/3R  | 07KA0328 | N/A     |
| 07BB14SP | FA18HH       | 07GR6407 | FA132   | 07HO22TT  | FA84/3TT | 07KA0414 | FA62    |
| 07BB1507 | FA95         | 07GR64TT | FA132   | 07HO2307  | FA124    | 07KA0506 | FA68    |
| 07BB1510 | FA95         | 07GR6527 | FA48    | 07HO23SA  | FA124HH  | 07KA0608 | FA68    |
| 07BB1511 | FA95         | 07GR6610 | FA16    | 07HO23SP  | FA124HH  | 07KA0717 | FA83TT  |
| 07BB15RC | FA95         | 07GR6706 | FA107A  | 07HO2408  | FA122    | 07KA07SD | FA83HH  |
| 07BB15SA | FA95HH       | 07GR68SA | FA345HH | 07HO2506  | FA125TT  | 07KA07SX | FA83R   |
| 07BB15SC | FA95HH       | 07GR69SD | FA357R  | 07HO25SD  | FA125R   | 07KA0808 | FA85    |
| 07BB1606 | FA163        | 07GR69SX | FA357R  | 07HO25SX  | FA125R   | 07KA08SA | FA85HH  |
| 07BB1710 | FA193        | 07GR70SD | FA325R  | 07HO25TT  | FA125TT  | 07KA08SP | FA85HH  |
| 07BB1750 | FA193HH      | 07GR70SX | FA325R  | 07HO2608  | FA131TT  | 07KA0933 | FA129   |
| 07BB1810 | FA193        | 07GR71SD | FA355R  | 07HO26SD  | FA131R   | 07KA09SA | FA129HH |
| 07BB1811 | FA193        | 07GR71SX | FA355R  | 07HO26SX  | FA131R   | 07KA09SP | FA129HH |
| 07BB1907 | FA244        | 07HD0105 | FA24/2  | 07HO26TT  | FA131TT  | 07KA10TT | FA130   |
| 07BB1910 | FA244        | 07HD0202 | FA71    | 07HO2711  | FA140    | 07KA1117 | FA141   |
| 07BB1950 | FA244HH      | 07HD0303 | FA72    | 07HO27SP  | FA140HH  | 07KA11SA | N/A     |
| 07BB19RC | FA244        | 07HD0413 | FA78    | 07HO2807  | FA187    | 07KA11SP | N/A     |
| 07BB19SA | FA244        | 07HD0507 | FA79    | 07HO28RC  | FA187    | 07KA12SD | FA152R  |
| 07BB19SC | FA244HH      | 07HD0614 | FA94    | 07HO28SA  | FA187HH  | 07KA12SX | FA152R  |
| 07BB2010 | FA266        | 07HD0910 | FA201   | 07HO28SC  | FA187HH  | 07KA12TT | FA152TT |
| 07BB2050 | FA266HH      | 07HD1011 | FA200   | 07HO2911  | FA143    | 07KA1306 | FA158   |
| 07BB2107 | FA171        | 07HD1109 | FA210   | 07HO29SP  | N/A      | 07KA13RC | FA158   |
| 07BB21SA | FA171HH      | 07HD1210 | FA400   | 07HO3005  | FA142    | 07KA13SA | FA158HH |
| 07BB2207 | FA407        | 07HD12SA | FA400HH | 07HO30RC  | FA142    | 07KA13SC | FA158HH |
| 07BB22SA | FA407HH      | 07HD12SP | FA400HH | 07HO30SA  | FA142HH  | 07KA1406 | FA180   |
| 07BB2307 | FA77         | 07HD13SA | FA381HH | 07HO30SC  | FA142HH  | 07KA14SA | FA180HH |
| 07BB2407 | FA407        | 07HD14SP | FA387HH | 07HO3109  | FA196    | 07KA14SC | FA180HH |

# DISC BRAKE PAD COMPETITOR INTERCHANGE LIST

DISC PADS  
BUYERS GUIDE

| BREMBO   | EBC       | BREMBO   | EBC       | BREMBO   | EBC       | BREMBO  | EBC      |
|----------|-----------|----------|-----------|----------|-----------|---------|----------|
| 07KA1617 | FA192     | 07SU1121 | FA128TT   | 07YA16SX | FA119R    | 07008   | FA99     |
| 07KA16SP | FA192HH   | 07SU11SD | FA128R    | 07YA1711 | FA123     | 07009   | FA116    |
| 07KA1705 | FA185TT   | 07SU11SX | FA128R    | 07YA17SA | FA123HH   | 07010   | FA131/2  |
| 07KA17SD | FA185R    | 07SU1215 | FA228     | 07YA17SP | FA123HH   | 07011   | FA131/3  |
| 07KA17SX | FA185R    | 07SU12SD | FA228HH   | 07YA1809 | FA118     | 07012   | FA194    |
| 07KA17TT | FA185TT   | 07SU12SX | FA135R    | 07YA18SA | N/A       | 07012ST | FA194HH  |
| 07KA1807 | FA231     | 07SU12TT | FA135TT   | 07YA1909 | FA136     | 07013   | FA186    |
| 07KA18RC | FA231     | 07SU1407 | FA236     | 07YA2008 | FA215/2   | 07013ST | N/A      |
| 07KA18SA | FA231HH   | 07SU14RC | FA236     | 07YA20SP | FA215/2HH | 07014   | FA382    |
| 07KA18SC | FA231HH   | 07SU14SA | FA236HH   | 07YA2106 | FA197     | 07015   | FA382    |
| 07KA1907 | FA229     | 07SU14SC | FA236HH   | 07YA21SA | FA197HH   | 07016   | FA234    |
| 07KA19RC | FA229     | 07SU1509 | FA147     | 07YA21SD | FA197HH   | 07017   | FA255    |
| 07KA19SA | FA229HH   | 07SU15SA | FA147R    | 07YA21SX | FA135R    | 07018   | FA235    |
| 07KA19SC | FA229HH   | 07SU15TT | FA147     | 07YA21TT | FA135TT   | 07018ST | N/A      |
| 07KA2009 | FA424     | 07SU1718 | FA157     | 07YA2206 | FA228     | 07019   | FA260    |
| 07KA20RC | FA424     | 07SU17SP | FA157R    | 07YA22SA | FA228HH   | 07019ST | FA260HH  |
| 07KA20SA | FA424HH   | 07SU17TT | FA157     | 07YA22SD | FA228HH   | 07020   | FA298    |
| 07KA20SC | FA424HH   | 07SU18SD | FA152/2R  | 07YA22TT | FA165TT   | 07020ST | N/A      |
| 07KA2107 | FA254     | 07SU18TT | FA152/2TT | 07YA2307 | FA252     | 07021   | FA321    |
| 07KA22SD | FA258TT   | 07SU1907 | FA188     | 07YA23RC | FA252     | 07021ST | N/A      |
| 07KA2305 | N/A       | 07SU19RC | FA188     | 07YA23SA | FA252HH   | 07022   | FA305    |
| 07KA23RC | N/A       | 07SU19SA | FA188HH   | 07YA23SC | FA252HH   | 07022ST | FA305R   |
| 07KA23A  | FA347HH   | 07SU19SC | FA188HH   | 07YA2409 | FA160     | 07023   | FA297    |
| 07KA23SC | FA347HH   | 07SU2007 | FA222     | 07YA24SA | FA160HH   | 07024   | FA257    |
| 07KA24SD | FA342R    | 07SU20SP | N/A       | 07YA24SC | FA160HH   | 07024ST | N/A      |
| 07KA25SX | FA349R    | 07SU22SA | FA236HH   | 07YA2508 | FA172TT   | 07025   | FA69/3   |
| 07KA26SA | FA294HH   | 07SU25SP | FA254HH   | 07YA25SA | FA172R    | 07025ST | FA69/3HH |
| 07KA27SD | FA302TT   | 07SU26RC | N/A       | 07YA25SC | FA172R    | 07026   | FA83TT   |
| 07KA27SX | FA302R    | 07SU26SA | FA369/4HH | 07YA2609 | FA182     | 07027   | FA167    |
| 07KS0124 | FA55      | 07SU26SC | FA369/4HH | 07YA26SA | FA182HH   | 07028   | FA131/3  |
| 07KS0207 | FA36      | 07SU27RC | N/A       | 07YA26SC | FA182HH   | 07028ST | N/A      |
| 07KS0321 | FA39      | 07SU27SA | FA379HH   | 07YA2709 | FA179     | 07029   | FA140    |
| 07KS0432 | FA67      | 07SU27SC | FA379HH   | 07YA27SA | FA179HH   | 07029ST | FA140HH  |
| 07KS04SD | FA67HH    | 07SU2906 | FA137TT   | 07YA3108 | FA191     | 07030   | FA174    |
| 07KS04SX | FA67R     | 07SU29SD | FA137R    | 07YA3208 | FA190     | 07031   | FA151    |
| 07KS04TT | FA67TT    | 07SU29SX | FA137R    | 07YA32SA | FA190HH   | 07032   | FA257    |
| 07KS0507 | FA63      | 07SU31SD | FA401R    | 07YA32SC | FA190HH   | 07033   | FA197    |
| 07KS05RC | FA63      | 07SU32SP | FA419HH   | 07YA3408 | FA199     | 07033ST | FA197HH  |
| 07KS05SP | FA63HH    | 07YA0113 | FA28      | 07YA34SA | FA199HH   | 07034   | FA281    |
| 07PO0106 | FA159TT   | 07YA0207 | FA11      | 07YA3509 | FA123     | 07034ST | FA261HH  |
| 07PO01SD | FA159R    | 07YA0309 | FA34      | 07YA35SA | FA123HH   | 07035   | FA228    |
| 07PO01SX | FA159R    | 07YA0413 | FA41      | 07YA3707 | FA275     | 07035ST | FA228HH  |
| 07PO02SD | FA159R    | 07YA0527 | FA42      | 07YA37SP | FA275HH   | 07036   | FA396    |
| 07PO03SD | FA232R    | 07YA0609 | FA64      | 07YA3807 | FA267     | 07036ST | N/A      |
| 07PO03SX | FA232R    | 07YA0713 | FA61      | 07YA38SP | FA267HH   | 07037   | FA283    |
| 07PO04SD | FA270R    | 07YA0809 | FA70      | 07YA3908 | FA319/2   | 07037ST | FA283HH  |
| 07PO04SX | FA270R    | 07YA1011 | FA81      | 07YA39SP | FA319/2HH | 07038   | FA323    |
| 07PO05SX | FA313R    | 07YA1107 | FA88      | 07YA4007 | FA348     | 07038ST | FA323HH  |
| 07PO06SD | FA314R    | 07YA11SA | FA88HH    | 07YA40SP | FA348HH   | 07039   | FA101    |
| 07PO06SX | FA314R    | 07YA11SP | FA88HH    | 07YA41SD | FA367R    | 07039ST | N/A      |
| 07PO07SD | FA354R    | 07YA1207 | FA104     | 07YA41SX | FA367R    | 07041   | FA169    |
| 07PO08SD | FA237R    | 07YA12SA | FA104HH   | 07YA44SD | FA155R    | 07041ST | FA169HH  |
| 07SU0125 | FA35      | 07YA12SP | FA104HH   | 07YA45SD | FA344R    | 07042   | FA199    |
| 07SU0220 | FA38      | 07YA13SD | FA105R    | 07001ST  | FA181TT   | 07042ST | FA199HH  |
| 07SU0312 | FA51      | 07YA13SX | FA105R    | 0700S    | FA193     | 07043   | FA275    |
| 07SU0412 | FA65      | 07YA13TT | FA105TT   | 07002ST  | FA193HH   | 07043ST | FA275HH  |
| 07SU0526 | FA46      | 07YA1407 | FA101     | 07003ST  | FA193HH   | 07045   | FA324    |
| 07SU0607 | FA103     | 07YA14SD | FA101R    | 07004    | FA266     | 07045ST | FA336    |
| 07SU0707 | FA102     | 07YA14SX | FA101R    | 07004ST  | FA266HH   | 07047   | FA321    |
| 07SU0808 | FA106/2TT | 07YA14TT | FA101TT   | 07005    | FA264     | 07048   | FA350    |
| 07SU08TT | FA106/2TT | 07YA1519 | FA21      | 07006    | FA256     | 07049   | FA194    |
| 07SU0904 | FA106TT   | 07YA1605 | FA119TT   | 07006ST  | FA256HH   | 07050   | FA355    |
| 07SU1005 | FA110     | 07YA16SD | FA119R    | 07007    | FA256     | 07051   | FA356    |

# DISC BRAKE PAD COMPETITOR INTERCHANGE LIST

| BREMBO  | EBC     | DUNLOPAD | EBC     | DUNLOPAD | EBC     | DUNLOPAD | EBC       |
|---------|---------|----------|---------|----------|---------|----------|-----------|
| 07052   | FA319   | DP101    | FA30    | DP315    | FA152   | DP626    | FA218     |
| 07052ST | FA319HH | DP102    | FA29    | DP316    | FA141   | DP627    | FA243     |
| 07053   | FA358   | DP103    | FA45    | DP317    | FA158   | DP628    | FA245     |
| 07054   | FA374   | DP104    | FA69/2  | DP318    | FA161   | DP629    | FA263     |
| 07055   | FA411   | DP105    | FA69    | DP319    | FA180   | DP630    | FA244     |
| 07056   | FA353   | DP106    | FA80    | DP320    | FA192   | DP631    | FA266     |
| 07057   | FA256   | DP107    | FA54    | DP321    | FA185   | DP633    | FA193     |
| 07058   | FA412   | DP108    | FA113   | DP322    | FA229   | DP634    | FA206     |
| 07059   | FA408   | DP109    | FA124   | DP323    | FA231   | DP635    | FA260     |
| 07059ST | N/A     | DP110    | FA121   | DP324    | FA249   | DP637    | FA304     |
| 07060   | FA418   | DP111    | FA86    | DP326    | FA258   | DP638    | FA322     |
| 07061   | FA425   | DP112    | FA187   | DP327    | FA307   | DP639    | FA294     |
| 07061ST | N/A     | DP113    | FA143   | DP328    | FA302   | DP640    | FA291     |
| 07062   | FA306   | DP114    | FA92/2  | DP400    | FA11    | DP641    | FA335     |
| 07063   | FA388   | DP115    | FA140   | DP401    | FA34    | DP701    | FA18      |
| 07064   | FA415   | DP116    | FA124/2 | DP402    | FA70    | DP811    | FA84      |
|         |         | DP117    | FA142   | DP403    | FA81    | DP812    | FA92      |
|         |         | DP118    | FA196   | DP404    | FA88    | DP813    | FA111     |
|         |         | DP119    | FA151   | DP405    | FA105   | DP814    | FA125     |
|         |         | DP120    | FA153   | DP406    | FA101   | DP815    | FA131     |
|         |         | DP121    | FA174   | DP407    | FA104   | DP816    | FA84/3    |
|         |         | DP122    | FA189   | DP408    | FA119   | DP817    | FA137     |
|         |         | DP123    | GFA239  | DP409    | FA123   | DP821    | FA67/2    |
|         |         | DP124    | FA281   | DP410    | FA160   | DP841    | FA21      |
|         |         | DP125    | FA261   | DP411    | FA135   | DP842    | FA20      |
|         |         | DP126    | FA261   | DP412    | FA165/2 | DP843    | FA155     |
|         |         | DP127    | FA265   | DP413    | FA172   | DP900    | FA94      |
|         |         | DP128    | FA261   | DP414    | FA179   | DP901    | FA78      |
|         |         | DP129    | FA343   | DP415    | FA182   | DP902    | FA159     |
|         |         | DP200    | FA55    | DP416    | FA190   | DP903    | FA54/2    |
|         |         | DP201    | FA55    | DP417    | FA136   | DP904    | FA201     |
|         |         | DP203    | FA36    | DP418    | FA252   | DP905    | FA200     |
|         |         | DP204    | FA141   | DP419    | FA267   | DP906    | FA24/2    |
|         |         | DP205    | FA51    | DP420    | FA275   | DP907    | FA71      |
|         |         | DP206    | FA65    | DP421    | FA199   | DP908    | FA72      |
|         |         | DP207    | FA63    | DP422    | FA268   | DP909    | FA232     |
|         |         | DP208    | FA106   | DP423    | FA319   | DP911    | FA216     |
|         |         | DP209    | FA106/2 | DP424    | FA275   | DP912    | FA210     |
|         |         | DP210    | FA103   | DP500    | FA16    | DP913    | FA216     |
|         |         | DP211    | FA135   | DP501    | FA196   | DP914    | FA271R    |
|         |         | DP212    | FA146   | DP600    | FA18    | DP915    | FA270R    |
|         |         | DP213    | FA145   | DP601    | FA47    | DP916    | FA32      |
|         |         | DP214    | FA147   | DP602    | FA99    | DP917    | FA76      |
|         |         | DP215    | FA157   | DP604    | FA126   | DP918    | FA299     |
|         |         | DP216    | FA188   | DP605    | FA134   | DP919    | FA307     |
|         |         | DP217    | FA222   | DP606    | FA132   | DP920    | FA317     |
|         |         | DP218    | FA230   | DP607    | FA115   | DP921    | FA346     |
|         |         | DP219    | FA283   | DP608    | FA171   | DP922    | FA347     |
|         |         | DP220    | FA254   | DP609    | FA164   | DP923    | FA357     |
|         |         | DP300    | FA33    | DP610    | FA116   | DP924    | FA325R    |
|         |         | DP302    | FA73    | DP611    | FA60    | DP926    | FA345     |
|         |         | DP303    | FA62    | DP612    | FA166   | DP927    | FA323/3   |
|         |         | DP304    | FA36    | DP613    | FA167   | DP928    | FA358     |
|         |         | DP305    | FA73    | DP614    | FA95    | DP929    | FA342R    |
|         |         | DP307    | FA58    | DP615    | FA170   | DP930    | FA344     |
|         |         | DP308    | FA68    | DP617    | FA181   | DP931    | FA348     |
|         |         | DP309    | FA68    | DP618    | FA163   | DP932    | FA314R    |
|         |         | DP310    | FA67    | DP620    | FA77    | DP935    | FA368     |
|         |         | DP310-C  | FA67    | DP621    | FA131/2 | DP936    | FA351     |
|         |         | DP311    | FA85    | DP622    | FA208   | DP937    | FA303     |
|         |         | DP312    | FA83    | DP623    | FA209   | DP940    | FA367     |
|         |         | DP313    | FA130   | DP624    | FA107A  | DP942    | FA369/4HH |
|         |         | DP314    | FA129   | DP625    | FA246   | DP944    | FA373R    |

DISC PADS  
BUYERS GUIDE

# DISC BRAKE PAD COMPETITOR INTERCHANGE LIST

DISC PADS  
BUYERS GUIDE

| DUNLOPAD | EBC     | FERODO   | EBC    | FERODO   | EBC     | FERODO   | EBC     |
|----------|---------|----------|--------|----------|---------|----------|---------|
| DP946    | FA366   | FDB 88   | FA27   | FDB 384  | FA93    | FDB 665  | FA69/3  |
| DP947    | FA379HH | FDB 108  | FA18   | FDB 386  | FA104   | FDB 666  | FA160   |
| DP948    | FA381   | FDB 108R | FA18   | FDB 386R | FA104   | FDB 672  | FA131/3 |
| DP949    | FA381   | FDB 119  | FA13   | FDB 389  | FA103   | FDB 673  | FA106/2 |
| DP950    | FA379HH | FDB 132  | FA33   | FDB 389R | FA103   | FDB 677  | FA194   |
| DP951    | FA352   | FDB 134R | FA32   | FDB 390  | FA102   | FDB 680  | FA193   |
| DP952    | FA194   | FDB 148  | FA18   | FRP 403  | FA11    | FDB 694  | FA60    |
| DP953    | FA401   | FDB 148R | FA18   | FDB 404  | FA106   | FDB 695  | FA74    |
| DP954    | FA388   | FDB 150  | FA35   | FRP 405  | FA115   | FDB 696  | FA98    |
| DP956    | FA395   | FDB 151R | FA36   | FRP 408  | FA95    | FDB 697  | FA116   |
| DP957    | FA400   | FDB 155  | FA22   | FRP 410  | GFA107A | FDB 698  | N/A     |
| DP958    | FA320   | FDB 157  | FA11   | FDB 411  | FA105   | FDB 699  | FA166   |
| DP959    | FA410   | FDB 177  | FA34   | FRP 415  | FA175   | FDB 705  | FA47    |
| DP961    | FA373   | FDB 177R | FA34   | FRP 418  | GFA217  | FDB 706  | FA167   |
| DP962    | FA409   | FDB 178  | FA38   | FRP 419  | FA95/2  | FDB 731  | FA67/2  |
| DP963    | FA419   | FDB 181R | FA37   | FDB 436  | FA99    | FDB 736  | FA171   |
| DP964    | FA417   | FDB 182  | FA30   | FDB 437  | FA110   | FDB 737  | FA172   |
| DP965    | FA423/4 | FDB 183  | FA45   | FDB 438  | FA113   | FDB 741  | FA180   |
| DP966    | FA411   | FDB 184  | FA41   | FDB 449  | FA123   | FDB 754  | FA174   |
| DP967    | FA377   | FDB 185  | FA24/2 | FDB 449R | FA123   | FDB 781  | FA179   |
| DP968    | FA412   | FDB 185R | FA24/2 | FDB 452  | FA124   | FDB 782  | FA177   |
| DP971    | FA434   | FDB 204  | FA77   | FDB 452R | FA124   | FDB 783  | FA131/2 |
| DP973    | FA436   | FDB 204R | FA77   | FDB 453  | FA119   | FDB 784  | FA186   |
| DP976    | FA442   | FDB 207  | FA47   | FDB 462  | FA121   | FDB 828  | FA173   |
| DP977    | FA435   | FDB 207R | FA47   | FDB 475  | FA101   | FDB 831  | FA150   |
| DP978    | FA447   | FDB 213  | FA76   | FDB 481  | FA129   | FDB 847  | FA210   |
| DP979    | FA443   | FRP 213  | FA16   | FDB 481R | FA129   | FDB 851  | FA142   |
| DP980    | FA444   | FDB 217  | FA65   | FDB 485  | FA201   | FDB 858  | FA187   |
| DP981    | FA445   | FDB 218  | FA51   | FDB 494  | FA130   | FDB 864  | FA190   |
| DP982    | FA446   | FDB 220  | FA62   | FDB 495  | FA125   | FDB 865  | FA191   |
| DP983    | FA450   | FDB 244  | FA69   | FDB 496  | FA143   | FDB 866  | FA156   |
|          |         | FDB 244R | FA69   | FDB 497  | FA135   | FDB 873  | FA188   |
|          |         | FDB 247  | FA61   | FDB 498  | FA126   | FDB 889  | FA206   |
|          |         | FDB 248  | FA42   | FDB 499  | FA134   | FDB 892  | FA185   |
|          |         | FDB 250  | FA54   | FDB 508  | FA141   | FDB 2001 | FA200   |
|          |         | FDB 277  | FA70   | FDB 521  | FA200   | FDB 2002 | FA189   |
|          |         | FDB 298  | FA68   | FDB 529  | FA163   | FDB 2003 | FA199   |
|          |         | FDB 298R | FA68   | FDB 531  | FA140   | FDB 2005 | FA208   |
|          |         | FDB 299  | FA68   | FDB 533  | FA187   | FDB 2006 | FA209   |
|          |         | FDB 310  | FA80   | FDB 538  | FA69/2  | FDB 2007 | FA218   |
|          |         | FDB 310R | FA80   | FDB 539  | FA131   | FDB 2008 | FA211   |
|          |         | FDB 311  | FA81   | FDB 557  | FA145   | FDB 2012 | FA192   |
|          |         | FDB 312  | FA86   | FDB 561  | FA132   | FDB 2013 | FA128   |
|          |         | FDB 313  | FA83   | FDB 568  | FA153   | FDB 2014 | FA21    |
|          |         | FDB 314  | FA67   | FDB 569  | FA146   | FDB 2015 | FA119   |
|          |         | FDB 333  | FA71   | FDB 570  | FA142   | FDB 2016 | FA137   |
|          |         | FDB 334  | FA72   | FDB 574  | FA158   | FDB 2017 | FA155   |
|          |         | FDB 334R | FA72   | FDB 583  | FA118   | FDB 2018 | FA181   |
|          |         | FDB 335  | FA78   | FDB 591  | FA136   | FDB 2019 | FA208   |
|          |         | FDB 335R | FA78   | FDB 592  | FA120   | FDB 2022 | FA196   |
|          |         | FDB 337  | FA88   | FDB 605  | FA252   | FDB 2031 | FA243   |
|          |         | FDB 337R | FA88   | FDB 606  | FA147   | FDB 2033 | FA361HH |
|          |         | FDB 338  | FA63   | FDB 607  | FA157   | FDB 2034 | FA362HH |
|          |         | FDB 338R | FA63   | FDB 625  | FA178   | FDB 2036 | FA249   |
|          |         | FDB 339  | FA85   | FDB 631  | FA165   | FDB 2037 | FA255   |
|          |         | FDB 339R | FA85   | FDB 636  | FA169   | FDB 2039 | FA245   |
|          |         | FDB 342  | FA16   | FDB 637  | FA182   | FDB 2040 | FA216   |
|          |         | FDB 342R | FA16   | FDB 657  | FA170   | FDB 2041 | FA216/2 |
|          |         | FDB 352  | FA94   | FDB 659  | FA152   | FDB 2042 | FA244   |
|          |         | FDB 352R | FA94   | FDB 661  | FA84/3  | FDB 2043 | FA263   |
|          |         | FDB 381  | FA84   | FDB 662  | FA123   | FDB 2044 | FA107A  |
|          |         | FDB 382  | FA92   | FDB 663  | FA124/2 | FDB 2048 | FA231   |
|          |         | FDB 383  | FA101  | FDB 664  | FA196   | FDB 2049 | FA229   |



# DISC BRAKE PAD COMPETITOR INTERCHANGE LIST

| FERODO   | EBC     | FERODO   | EBC      | LOCKHEED | EBC    | LOCKHEED | EBC     |
|----------|---------|----------|----------|----------|--------|----------|---------|
| FDB 2050 | FA246   | FDB 2142 | FA353    | LMP100   | FA28   | LMP161   | FA90    |
| FDB 2053 | FA201   | FDB 2143 | FA343    | LMP101   | FA13   | LMP162   | FA84    |
| FDB 2054 | FA232   | FDB 2144 | FA188    | LMP102   | FA12   | LMP166   | FA95    |
| FDB 2055 | FA159   | FDB 2145 | FA345    | LMP103   | FA55   | LMP170   | FA104   |
| FDB 2056 | FA255   | FDB 2146 | FA256    | LMP104   | FA11   | LMP171   | FA80/2  |
| FDB 2057 | FA260   | FDB 2147 | FA374    | LMP105   | FA27   | LMP172   | FA69/2  |
| FDB 2058 | FA222   | FDB 2148 | FA307    | LMP106   | FA18   | LMP173   | FA109   |
| FDB 2059 | FA196   | FDB 2149 | FA317    | LMP107   | FA34   | LMP174   | FA60    |
| FDB 2060 | FA256   | FDB 2150 | FA348    | LMP108   | FA29   | LMP175   | FA101   |
| FDB 2062 | FA268   | FDB 2153 | N/A      | LMP109   | FA32   | LMP176   | FA21    |
| FDB 2073 | FA261   | FDB 2155 | N/A      | LMP110   | *FA33/ | LMP177   | FA103   |
| FDB 2074 | FA266   | FDB 2156 | FA319/2  |          | FA73   | LMP178   | FA102   |
| FDB 2075 | FA261   | FDB 2157 | FA357    | LMP111   | FA35   | LMP179   | FA94    |
| FDB 2079 | FA265   | FDB 2158 | FA347    | LMP112   | FA36   | LMP180   | FA105   |
| FDB 2080 | FA258   | FDB 2162 | FA367    | LMP113   | FA24   | LMP181   | FA106   |
| FDB 2081 | FA47    | FDB 2163 | FA366    | LMP114   | FA37   | LMP182   | FA106/2 |
| FDB 2083 | FA275   | FDB 2164 | FA369/4  | LMP115   | FA38   | LMP183   | FA47/2  |
| FDB 2084 | FA267   | FDB 2165 | FA368    | LMP116   | FA39   | LMP184   | FA84/2  |
| FDB 2085 | FA283   | FDB 2166 | GFA435/4 | LMP117   | *FA30/ | LMP185   | FA93    |
| FDB 2086 | FA323/3 | FDB 2167 | GF263    |          | FA31   | LMP187   | FA110   |
| FDB 2087 | FA197   | FDB 2168 | N/A      | LMP118   | NONE   | LMP188   | FA113   |
| FDB 2090 | FA298   | FDB 2169 | FA375    | LMP119   | FA47   | LMP189   | FA119   |
| FDB 2091 | FA515   | FDB 2170 | N/A      | LMP120   | FA22   | LMP190   | FA123   |
| FDB 2095 | FA301   | FDB 2171 | N/A      | LMP121   | FA43   | LMP191   | FA67/2  |
| FDB 2096 | FA305   | FDB 2178 | FA412    | LMP122   | FA48   | LMP192   | FA84    |
| FDB 2097 | FA299   | FDB 2175 | FA271    | LMP123   | FA16   | LMP193   | FA121   |
| FDB 2098 | FA261   | FDB 2176 | FA314    | LMP124   | FA56   | LMP194   | FA120   |
| FDB 2099 | FA244   | FDB 2177 | FA313    | LMP125   | FA40   | LMP195   | FA99    |
| FDB 2100 | FA186   | FDB 2178 | FA379    | LMP126   | FA45   | LMP196   | FA118   |
| FDB 2101 | FA234   | FDB 2179 | FA381    | LMP127   | FA57   | LMP197   | FA129   |
| FDB 2102 | FA304   | FDB 2180 | FA387    | LMP128   | FA41   | LMP198   | FA122   |
| FDB 2103 | FA291   | FDB 2181 | FA390    | LMP129   | FA52   | LMP199   | RFA107  |
| FDB 2105 | FA324   | FDB 2182 | FA373    | LMP130   | FA62   | LMP200   | FA124   |
| FDB 2106 | FA194   | FDB 2183 | FA325    | LMP131   | FA42   | LMP201   | FA126   |
| FDB 2107 | FA115   | FDB 2184 | FA377    | LMP132   | FA50   | LMP202   | FA130   |
| FDB 2108 | FA306   | FDB 2185 | FA426    | LMP133   | FA51   | LMP203   | FA125   |
| FDB 2109 | FA303   | FDB 2186 | FA418    | LMP134   | FA65   | LMP204   | FA131   |
| FDB 2110 | FA302   | FDB 2187 | FA142    | LMP135   | FA64   | LMP205   | FA98    |
| FDB 2111 | FA254   | FDB 2188 | FA342    | LMP136   | FA54   | LMP206   | FA111   |
| FDB 2113 | FA203   | FDB 2189 | N/A      | LMP137   | FA71   | LMP207   | FA116   |
| FDB 2114 | FA296   | FDB 2190 | FA264    | LMP138   | FA46   | LMP208   | FA134   |
| FDB 2115 | FA321   | FDB 2191 | FA235    | LMP139   | FA68   | LMP209   | FA201   |
| FDB 2116 | FA323   | FDB 2192 | FA151    | LMP140   | FA68   | LMP210   | FA111   |
| FDB 2120 | FA322HH | FDB 2193 | FA344    | LMP141   | FA67/2 | LMP211   | FA135   |
| FDB 2121 | FA270R  | FDB 2194 | FA162    | LMP142   | FA69   | LMP212   | FA200   |
| FDB 2122 | N/A     | FDB 2196 | FA388    | LMP143   | FA72   | LMP213   | FA123   |
| FDB 2123 | FA295   | FDB 2197 | FA401    | LMP144   | FA83   | LMP214   | FA140   |
| FDB 2124 | FA294HH | FDB 2198 | FA320    | LMP145   | FA61   | LMP215   | FA141   |
| FDB 2125 | FA335HH | FDB 2200 | FA408    | LMP146   | FA67   | LMP216   | FA136   |
| FDB 2126 | FA319   | FDB 2201 | FA399    | LMP147   | FA70   | LMP217   | FA20    |
| FDB 2127 | FA351   | FDB 2203 | FA369/4  | LMP148   | FA83/2 | LMP218   | FA151   |
| FDB 2128 | FA350   | FDB 2204 | FA379    | LMP149   | FA78   | LMP219   | FA169   |
| FDB 2129 | FA297   | FDB 2205 | FA390    | LMP150   | FA81   | LMP220   | FA146   |
| FDB 2130 | FA358   |          |          | LMP151   | FA86   | LMP221   | FA132   |
| FDB 2131 | FA196   | FRP 213  | FA16     | LMP152   | FA80   | LMP222   | FA144   |
| FDB 2132 | FA323/3 | FRP 219  | FA95/2   | LMP153   | FA79   | LMP223   | FA143   |
| FDB 2133 | FA230   | FRP 405  | FA115    | LMP154   | FA77   | LMP224   | FA145   |
| FDB 2134 | FA227   | FRP 408  | FA95     | LMP155   | FA88   | LMP225   | FA204   |
| FDB 2135 | N/A     | FRP 410  | FA107A   | LMP156   | FA63   | LMP226   | FA147   |
| FDB 2136 | N/A     | FRP 415  | FA175    | LMP157   | FA85   | LMP227   | FA142   |
| FDB 2139 | FA346   | FRP 416  | FA47/3   | LMP158   | FA92   | LMP228   | FA151   |
| FDB 2140 | FA356   | FRP 417  | FA183    | LMP159   | FA115  | LMP229   | FA153   |
| FDB 2141 | FA357   | FRP 419  | FA95     | LMP160   | FA76   | LMP230   | FA196   |

# DISC BRAKE PAD COMPETITOR INTERCHANGE LIST

DISC PADS  
BUYERS GUIDE

| LOCKHEED | EBC     | SBS | EBC    | SBS | EBC     | SBS | EBC     |
|----------|---------|-----|--------|-----|---------|-----|---------|
| LMP231   | FA158   | 500 | FA28   | 563 | FA75/2  | 628 | FA151   |
| LMP232   | FA152   | 501 | FA13   | 565 | FA89    | 629 | FA153   |
| LMP233   | FA165   | 502 | FA12   | 566 | FA95    | 630 | FA196   |
| LMP234   | FA252   | 503 | FA55   | 568 | FA96    | 631 | FA158   |
| LMP235   | FA157   | 504 | FA11   | 569 | FA149/2 | 632 | FA152   |
| LMP236   | FA164   | 505 | FA27   | 570 | FA104   | 633 | FA165   |
| LMP238   | FA165   | 506 | FA18   | 571 | FA80/2  | 634 | FA252   |
| LMP239   | FA220   | 507 | FA34   | 572 | FA69/2  | 635 | FA157   |
| LMP240   | FA171   | 508 | FA29   | 573 | FA109   | 636 | FA164   |
| LMP242   | FA159   | 509 | FA32   | 574 | FA60    | 637 | FA155   |
| LMP243   | FA178   | 510 | FA33   | 575 | FA101   | 638 | FA165   |
| LMP244   | FA170   | 511 | FA35   | 576 | FA21    | 639 | FA220   |
| LMP245   | FA160   | 512 | FA36   | 577 | FA103   | 640 | FA171   |
| LMP246   | FA47/3  | 513 | FA24/2 | 578 | FA102   | 641 | FA163   |
| LMP247   | FA124/2 | 514 | FA37   | 579 | FA94    | 642 | FA159   |
| LMP248   | FA152   | 515 | FA38   | 580 | FA105   | 643 | FA54    |
| LMP296   | FA113   | 516 | FA39   | 581 | FA106   | 644 | FA170   |
| LMP297   | FA193   | 517 | FA31   | 582 | FA106/2 | 645 | FA123   |
| LMP298   | FA16    | 519 | FA47   | 583 | FA47/2  | 646 | FA47/3  |
| LMP299   | FA198   | 520 | FA22   | 584 | FA84/2  | 647 | FA124/2 |
| LMP300   | FA196   | 521 | FA43   | 585 | FA93    | 648 | FA152   |
| LMP301   | FA222   | 522 | FA48   | 586 | FA67    | 649 | FA137   |
| LMP302   | FA230   | 523 | FA16   | 587 | FA110   | 650 | FA172   |
| LMP303   | FA246   | 524 | FA56   | 588 | FA113   | 651 | FA173   |
| LMP304   | FA231   | 525 | FA40   | 589 | FA119   | 652 | FA167   |
| LMP305   | FA229   | 526 | FA45   | 590 | FA123   | 653 | FA166   |
| LMP306   | FA244   | 527 | FA57   | 591 | FA128   | 654 | FA196   |
| LMP307   | FA263   | 528 | FA41   | 592 | FA84    | 655 | FA184   |
| LMP308   | FA264   | 529 | FA52   | 593 | FA121   | 656 | FA175   |
| LMP309   | FA92/3  | 530 | FA62   | 594 | FA120   | 657 | FA174   |
| LMP310   | FA234   | 531 | FA48   | 595 | FA99    | 658 | FA210   |
| LMP311   | FA218/2 | 532 | FA50   | 596 | FA118   | 659 | FA162   |
| LMP312   | FA255   | 533 | FA51   | 597 | FA129   | 660 | GFA217  |
| LMP313   | FA228   | 534 | FA65   | 598 | FA122   | 661 | FA107A  |
| LMP314   | FA145   | 535 | FA64   | 599 | FA107   | 662 | FA95    |
| LMP315   | FA254   | 536 | FA54   | 600 | FA124   | 663 | FA179   |
| LMP316   | FA159   | 537 | FA71   | 601 | FA126   | 664 | N/A     |
| LMP317   | FA232   | 538 | FA46   | 602 | FA130   | 665 | FA182   |
| LMP318   | FA47    | 539 | FA66   | 603 | FA125   | 666 | FA180   |
| LMP319   | N/A     | 540 | FA68   | 604 | FA131   | 667 | FA193   |
| LMP320   | N/A     | 541 | FA67/2 | 605 | FA98    | 668 | FA201   |
| LMP321   | FA261   | 542 | FA69   | 606 | FA111   | 669 | FA200   |
| LMP322   | FA261   | 543 | FA72   | 607 | FA116   | 670 | FA257   |
|          |         | 544 | FA83   | 608 | FA134   | 671 | FA181   |
|          |         | 545 | FA61   | 609 | FA201   | 672 | FA156   |
|          |         | 546 | FA67   | 610 | FA117   | 673 | FA131/2 |
|          |         | 547 | FA70   | 611 | FA135   | 676 | FA249   |
|          |         | 548 | FA83/2 | 612 | FA200   | 677 | FA183   |
|          |         | 549 | FA78   | 613 | FA123   | 678 | FA95    |
|          |         | 550 | FA81   | 614 | FA140   | 679 | FA26    |
|          |         | 551 | FA86   | 615 | FA141   | 680 | FA116   |
|          |         | 552 | FA80   | 616 | FA136   | 681 | FA177   |
|          |         | 553 | FA79   | 617 | FA20    | 682 | FA191   |
|          |         | 554 | FA77   | 618 | FA151   | 683 | FA190   |
|          |         | 555 | FA88   | 619 | FA169   | 684 | FA173   |
|          |         | 556 | FA63   | 620 | FA146   | 685 | FA189   |
|          |         | 557 | FA85   | 621 | FA132   | 686 | FA188   |
|          |         | 558 | FA92   | 622 | FA187   | 687 | FA192   |
|          |         | 559 | FA115  | 623 | FA143   | 688 | FA197   |
|          |         | 560 | FA76   | 624 | FA145   | 689 | FA194   |
|          |         | 561 | FA90   | 625 | N/A     | 690 | FA131/3 |
|          |         | 562 | FA84   | 626 | FA147   | 691 | FA199   |
|          |         | 563 | FA75   | 627 | FA142   | 692 | FA67    |

# DISC BRAKE PAD COMPETITOR INTERCHANGE LIST

DISC PADS  
BUYERS GUIDE

| SBS | EBC    | SBS | EBC      | SBS | EBC     | VESRAH   | EBC     |
|-----|--------|-----|----------|-----|---------|----------|---------|
| 694 | FA185  | 758 | FA271R   | 834 | FA436   | VD-101   | FA12    |
| 695 | FA218  | 760 | N/A      | 835 | FA413   | VD-102   | FA13    |
| 696 | FA113  | 761 | FA324    | 836 | FA414   | VD-103   | FA13    |
| 697 | FA193  | 762 | FA322HH  | 837 | FA430   | VD-104   | FA13    |
| 698 | FA16   | 763 | FA320    | 838 | FA417/4 | VD-105   | FA13    |
| 699 | FA198  | 764 | FA336    | 839 | FA442/4 | VD-106   | FA13    |
| 700 | FA196  | 765 | FA254    | 840 | FA450   | VD-107   | FA29    |
| 701 | FA222  | 766 | N/A      | 841 | FA447   | VD-108   | FA32    |
| 702 | FA230  | 767 | FA317    | 842 | FA405   | VD-109   | FA40    |
| 703 | FA246  | 768 | FA319    | 843 | FA433/4 | VD-110   | FA43    |
| 704 | FA231  | 769 | FA319/2  | 844 | FA432   | VD-111   | FA40    |
| 705 | FA229  | 770 | FA348    |     |         | VD-112   | FA31    |
| 706 | FA244  | 771 | FA193    |     |         | VD-112/2 | FA29    |
| 707 | FA263  | 777 | FA346    |     |         | VD-112/3 | FA30    |
| 708 | FA264  | 778 | FA294    |     |         | VD-113   | FA45    |
| 709 | FA92/3 | 779 | FA249/2  |     |         | VD-114   | FA29    |
| 710 | FA234  | 781 | FA411    |     |         | VD-115   | FA30    |
| 711 | FA255  | 782 | FA347    |     |         | VD-116   | FA32    |
| 712 | FA255  | 783 | FA357    |     |         | VD-117   | FA45    |
| 713 | FA228  | 785 | N/A      |     |         | VD-118   | FA30    |
| 714 | FA145  | 787 | FA314    |     |         | VD-119   | FA52    |
| 715 | FA254  | 788 | FA369    |     |         | VD-120   | FA54    |
| 716 | FA159  | 789 | FA366    |     |         | VD-122   | FA83/2  |
| 717 | FA232  | 790 | FA367    |     |         | VD-123   | FA69    |
| 718 | FA47   | 791 | FA368    |     |         | VD-123/2 | FA69/2  |
| 719 | FA272  | 793 | FA256    |     |         | VD-123/3 | FA69/3  |
| 720 | N/A    | 794 | FA325R   |     |         | VD-123/4 | FA69/3  |
| 721 | FA261  | 795 | FA345    |     |         | VD-124   | FA69/2  |
| 722 | FA261  | 796 | FA335    |     |         | VD-125   | FA29    |
| 723 | FA235  | 797 | FA375    |     |         | VD-126   | FA130   |
| 724 | FA260  | 798 | FA349    |     |         | VD-127   | FA84/3  |
| 725 | FA193  | 799 | FA344    |     |         | VD-127/2 | FA84    |
| 726 | FA258  | 800 | FA354    |     |         | VD-127/3 | FA84/2  |
| 727 | FA244  | 801 | FA342    |     |         | VD-128   | FA84    |
| 728 | FA275  | 802 | FA303    |     |         | VD-129   | FA80/2  |
| 729 | FA249  | 803 | FA351    |     |         | VD-129   | FA197   |
| 730 | FA266  | 804 | FA412    |     |         | VD-129/2 | FA80    |
| 731 | FA258  | 805 | GFA435/4 |     |         | VD-130   | FA90    |
| 732 | N/A    | 806 | FA379    |     |         | VD-131   | FA86    |
| 733 | FA267  | 807 | FA381    |     |         | VD-132   | FA69    |
| 734 | FA265  | 808 | FA387    |     |         | VD-133   | FA69/3  |
| 735 | FA261  | 809 | FA390    |     |         | VD-134   | FA92    |
| 736 | FA261  | 810 | FA377    |     |         | VD-135   | FA80    |
| 737 | FA47   | 812 | FA408    |     |         | VD-136   | FA92/2  |
| 738 | FA196  | 813 | FA373    |     |         | VD-137   | FA176   |
| 740 | FA283  | 814 | FA86     |     |         | VD-138   | FA111   |
| 741 | FA295  | 815 | FA291    |     |         | VD-138/2 | FA111/2 |
| 742 | FA363  | 816 | FA428    |     |         | VD-139   | FA125   |
| 743 | FA294  | 817 | FA167    |     |         | VD-139/2 | FA143   |
| 744 | FA206  | 818 | FA418    |     |         | VD-140   | FA109   |
| 745 | FA297  | 819 | FA115    |     |         | VD-141   | FA121   |
| 746 | FA304  | 820 | FA401    |     |         | VD-142   | FA121   |
| 747 | FA298  | 821 | FA399    |     |         | VD-143   | FA124   |
| 748 | FA301  | 822 | FA395    |     |         | VD-143/2 | FA124/2 |
| 749 | FA305  | 823 | FA393    |     |         | VD-144   | FA131   |
| 750 | FA299  | 824 | FA47     |     |         | VD-144/2 | FA131   |
| 751 | N/A    | 825 | N/A      |     |         | VD-146   | FA122   |
| 752 | FA302  | 826 | FA400    |     |         | VD-147   | FA140   |
| 753 | FA174  | 829 | FA410    |     |         | VD-150   | FA151   |
| 754 | FA307  | 830 | FA409    |     |         | VD-152   | FA113   |
| 755 | FA270R | 831 | FA425    |     |         | VD-153   | FA153   |
| 756 | FA273R | 832 | FA415    |     |         | VD-154   | FA187   |
| 757 | FA313R | 833 | FA419    |     |         | VD-156   | FA142   |

# DISC BRAKE PAD COMPETITOR INTERCHANGE LIST

DISC PADS  
BUYERS GUIDE

| VESRAH   | EBC     | VESRAH   | EBC     | VESRAH   | EBC     | VESRAH   | EBC    |
|----------|---------|----------|---------|----------|---------|----------|--------|
| VD-156/2 | FA196   | VD-259   | FA199   | VD-342/2 | FA83/2  | VD-903   | FA71   |
| VD-160   | N/A     | VD-260   | FA199   | VD-343   | FA158   | VD-904   | FA27   |
| VD-161   | FA185   | VD-261   | FA155   | VD-344   | FA158   | VD-906   | FA16   |
| VD-162   | FA257   | VD-262   | FA244   | VD-344/2 | FA158   | VD-907   | FA18   |
| VD-163   | FA174   | VD-263   | N/A     | VD-345   | FA146   | VD-907/2 | FA18   |
| VD-164   | FA189   | VD-264   | FA267   | VD-345/2 | FA146   | VD-908   | FA71   |
| VD-165   | FA261   | VD-265   | FA275   | VD-346   | FA93    | VD-909   | FA72   |
| VD-166   | FA265   | VD-266   | FA307   | VD-347   | FA147   | VD-910   | FA22   |
| VD-166/2 | FA265   | VD-266/2 | FA413   | VD-348   | FA157   | VD-911   | FA47   |
| VD-168   | FA346   | VD-267   | FA336   | VD-349   | FA188   | VD-911/2 | FA47/3 |
| VD-169   | FA358   | VD-268   | FA348   | VD-350   | FA222   | VD-912   | FA50   |
| VD-170   | FA390   | VD-269   | FA319   | VD-351   | FA230   | VD-913   | FA18   |
| VD-171   | FA373   | VD-269/2 | FA319/2 | VD-352   | FA231   | VD-915   | FA24/2 |
| VD-172   | FA388   | VD-270   | FA344   | VD-353   | FA283   | VD-916   | N/A    |
| VD-173   | FA415   | VD-271   | FA367   | VD-354   | FA369/4 | VD-917   | FA79   |
| VD-174   | FA436   | VD-272   | FA384   | VD-354   | FA423/4 | VD-918   | FA78   |
| VD-175   | FA410   | VD-273   | FA393   | VD-355   | FA379   | VD-919   | FA94   |
| VD-201   | FA11    | VD-274   | FA380   | VD-356   | FA411   | VD-920   | FA60   |
| VD-202   | FA28    | VD-275   | FA408   | VD-357   | FA412   | VD-921   | N/A    |
| VD-203   | FA28    | VD-276   | FA428   | VD-358   | FA401   | VD-922   | FA201  |
| VD-204   | FA11    | VD-277   | FA442/4 | VD-359   | FA419   | VD-923   | FA200  |
| VD-205   | FA34    | VD-301   | FA55    | VD-401   | FA55    | VD-924   | FA120  |
| VD-206   | FA34    | VD-302   | FA55    | VD-402   | FA55    | VD-925   | FA115  |
| VD-207   | FA34    | VD-303   | FA55    | VD-403   | N/A     | VD-926   | FA204  |
| VD-208   | FA34    | VD-304   | FA55    | VD-404   | FA33    | VD-927   | FA163  |
| VD-209   | FA34    | VD-305   | FA35    | VD-405   | FA37    | VD-928   | FA76   |
| VD-210   | FA34    | VD-306   | FA36    | VD-406   | FA36    | VD-929   | FA134  |
| VD-211   | FA34    | VD-306/2 | RFA36/2 | VD-408   | FA33    | VD-930   | FA98   |
| VD-212   | FA34    | VD-307   | FA38    | VD-409   | FA33    | VD-931   | FA111  |
| VD-213   | FA42    | VD-308   | FA38    | VD-410   | FA39    | VD-932   | FA99   |
| VD-214   | FA34    | VD-309   | FA39    | VD-411   | FA33    | VD-933   | FA77   |
| VD-215   | FA41    | VD-310   | FA38    | VD-412   | FA37    | VD-934   | FA171  |
| VD-216   | FA61    | VD-311   | FA36    | VD-413   | FA48    | VD-935   | FA57   |
| VD-221   | FA64    | VD-312   | FA56    | VD-414   | FA33    | VD-936   | FA132  |
| VD-222   | FA20    | VD-313   | FA35    | VD-415   | FA36/2  | VD-937   | FA116  |
| VD-228   | FA70    | VD-314   | FA46    | VD-416   | FA161   | VD-938   | FA164  |
| VD-231   | FA81    | VD-315   | FA38    | VD-417   | FA73    | VD-939   | FA54/2 |
| VD-234   | FA21    | VD-316   | FA38    | VD-419   | N/A     | VD-940   | FA159  |
| VD-235   | FA81    | VD-318   | FA35    | VD-420   | FA68    | VD-941   | FA170  |
| VD-236   | FA88    | VD-320   | FA38    | VD-420/2 | FA68    | VD-942   | FA134  |
| VD-237   | FA38A   | VD-322   | FA51    | VD-421   | FA68    | VD-943   | FA126  |
| VD-238   | FA89    | VD-323   | FA51    | VD-422   | FA83    | VD-945   | FA95   |
| VD-239   | FA101   | VD-324   | FA65    | VD-423   | FA62    | VD-947   | FA245  |
| VD-240   | FA104   | VD-325   | FA67    | VD-424   | FA85    | VD-948   | FA193  |
| VD-241   | FA105   | VD-327   | FA63    | VD-425   | FA173   | VD-950   | FA232  |
| VD-242   | FA123   | VD-327/2 | FA161   | VD-426   | FA85    | VD-953   | FA208  |
| VD-242/2 | FA123   | VD-328   | FA102   | VD-427   | FA129   | VD-955   | FA255  |
| VD-244   | FA119   | VD-329   | FA106   | VD-428   | FA130   | VD-956   | FA201  |
| VD-245   | FA118   | VD-329/2 | FA106/2 | VD-430   | FA141   | VD-957   | FA200  |
| VD-246   | FA136   | VD-330   | FA103   | VD-432   | FA152   | VD-958   | FA209  |
| VD-247   | FA169   | VD-331   | FA103   | VD-432/2 | FA152/2 | VD-959   | FA246  |
| VD-248   | FA252   | VD-331/2 | FA150   | VD-433   | FA180   | VD-960   | FA268  |
| VD-249   | FA220   | VD-332   | FA67/2R | VD-434   | FA192   | VD-961   | GFA263 |
| VD-250   | FA214   | VD-333   | FA54    | VD-435   | FA259   | VD-962   | FA234  |
| VD-250/2 | FA215/2 | VD-334   | FA84/2  | VD-437   | FA249   | VD-963   | FA270  |
| VD-251   | FA160   | VD-335   | FA110   | VD-438   | FA258   | VD-964   | FA266  |
| VD-252   | FA172   | VD-336   | FA84    | VD-439   | FA294   | VD-965   | FA271  |
| VD-253   | FA169   | VD-337   | FA106/2 | VD-440   | FA302   | VD-967   | FA194  |
| VD-254   | FA115   | VD-338   | FA103   | VD-441   | FA342   | VD-968   | FA260  |
| VD-255   | FA179   | VD-339   | FA83    | VD-442   | FA349   | VD-967   | FA194  |
| VD-256   | FA206   | VD-340   | FA214   | VD-443   | FA347   | VD-968   | FA260  |
| VD-257   | FA182   | VD-341   | FA137   | VD-901   | FA26    | VD-969/2 | FA295  |
| VD-258   | FA190   | VD-342   | FA83    | VD-902   | FA24/2  | VD-971   | FA299  |

# DISC BRAKE PAD COMPETITOR INTERCHANGE LIST

| VESRAH   | EBC      | VESRAH | EBC | VESRAH | EBC | VESRAH | EBC |
|----------|----------|--------|-----|--------|-----|--------|-----|
| VD-972   | FA304    |        |     |        |     |        |     |
| VD-973   | FA313    |        |     |        |     |        |     |
| VD-974   | FA298    |        |     |        |     |        |     |
| VD-975   | FA210    |        |     |        |     |        |     |
| VD-976   | FA301    |        |     |        |     |        |     |
| VD-977   | -        |        |     |        |     |        |     |
| VD-978   | -        |        |     |        |     |        |     |
| VD-979/2 | FA414    |        |     |        |     |        |     |
| VD-981   | FA321    |        |     |        |     |        |     |
| VD-982   | FA177    |        |     |        |     |        |     |
| VD-983   | FA353    |        |     |        |     |        |     |
| VD-984   | -        |        |     |        |     |        |     |
| VD-986   | FA322/4  |        |     |        |     |        |     |
| VD-987   | FA355    |        |     |        |     |        |     |
| VD-988   | FA356    |        |     |        |     |        |     |
| VD-991   | FA325    |        |     |        |     |        |     |
| VD-992   | FA314    |        |     |        |     |        |     |
| VD-993   | FA345    |        |     |        |     |        |     |
| VD-994   | FA306    |        |     |        |     |        |     |
| VD-995   | FA305    |        |     |        |     |        |     |
| VD-996   | FA235    |        |     |        |     |        |     |
| VD-997   | FA368    |        |     |        |     |        |     |
| VD-998   | FA320    |        |     |        |     |        |     |
| VD-999   | FA350    |        |     |        |     |        |     |
| VD-9000  | FA335    |        |     |        |     |        |     |
| VD-9001  | FA303    |        |     |        |     |        |     |
| VD-9002  | FA352    |        |     |        |     |        |     |
| VD-9003  | FA351    |        |     |        |     |        |     |
| VD-9006  | FA357    |        |     |        |     |        |     |
| VD-9007  | FA167    |        |     |        |     |        |     |
| VD-9009  | FA381    |        |     |        |     |        |     |
| VD-9010  | FA387    |        |     |        |     |        |     |
| VD-9011  | TBA      |        |     |        |     |        |     |
| VD-9012  | FA264    |        |     |        |     |        |     |
| VD-9013  | FA374    |        |     |        |     |        |     |
| VD-9015  | FA194    |        |     |        |     |        |     |
| VD-9017  | FA324    |        |     |        |     |        |     |
| VD-9019  | FA297    |        |     |        |     |        |     |
| VD-9020  | FA294    |        |     |        |     |        |     |
| VD-9022  | FA400    |        |     |        |     |        |     |
| VD-9023  | FA395    |        |     |        |     |        |     |
| VD-9024  | FA354    |        |     |        |     |        |     |
| VD-9025  | FA409    |        |     |        |     |        |     |
| VD-9026  | FA377    |        |     |        |     |        |     |
| VD-9027  | GFA183HH |        |     |        |     |        |     |
| VD-9030  | MXS405   |        |     |        |     |        |     |

DISC PADS  
BUYERS GUIDE

# BRAKE SHOE BUYERS GUIDE

| Part No.         | Make/Model                            | Year  |     | Part No.          | Make/Model                       | Year  |     |
|------------------|---------------------------------------|-------|-----|-------------------|----------------------------------|-------|-----|
| <b>H301</b>      | <b>HONDA</b>                          |       |     | <b>H303 Cont.</b> | <b>HONDA Cont.</b>               |       |     |
| 06430 GAB 003    | CRF 50 F4/F5/F6/F7                    | 04-07 | F&R |                   | SH 100 T/W/X/Y/1 Scoopy          | 96-01 | R   |
| 06430 GA8 003    | NB 50 ME Aero                         | 84    | F   |                   | SJ 100 T 'Bali Ex'               | 96-99 | R   |
| 06430 GZ9 003    | NB 50 MF/MG/TH 'Vision'               | 86-88 | F   |                   | CT 110 K/M/P                     | 89-93 | F   |
| 06450 147 671    | NE 50 MF/MG 'Vision'                  | 86-87 | F   |                   | SL 125 'K1A'                     | 76    | F&R |
| 43120 GK8 305    | NC 50 K1/KZ 'Express'                 | 79-82 | F&R |                   | CB 125 S                         | 75-79 | F&R |
| 43120 GZ9 003    | NC 50 C 'Express 2'                   | 82    | F   |                   | CG 125 K/B/C/E                   | 77-84 | F&R |
| 45120 044 003    | NC 50 A/B 'Express 3 Delux'           | 82    | F   |                   | CG 125 BR-K/BR-T                 | 85-97 | R   |
| 45120 063 003    | NP 50 D 'Melody Mini'                 | 83    | F   |                   | CH 125 D/E/G 'Spacy'             | 84-86 | F&R |
| 45120 147 010    | NS 50 'Melody'/MSB 'Melody Delux'     | 82    | F   |                   | CH 125 J/L/M/N/P/R/T Spacy       | 88-96 | F&R |
| 45120 147 671    | NT 50 F/G/H 'Melody Mini'             | 85-87 | F&R |                   | NH 125 MD-D 'Lead'               | 83    | F&R |
| 45120 147 672    | NX 50 A/B/MB 'Caren'                  | 80-82 | F   |                   | NH 125 "Lead 125"                | 86-87 | R   |
| 45120 GE8 003    | PC 50 K1                              | 79    | F&R |                   | NS 125 FG/FH/RH                  | 86-90 | R   |
| 45120 GE8 505    | QR 50 D/E/F                           | 83-87 | F   |                   | NX 125 K/S/F Transcity           | 89-97 | R   |
|                  | QR 50 M/R/V/W/Y                       | 93-03 | F   |                   | Passing 125                      | 93-97 | R   |
|                  | XR 50 R1/R2/R3                        | 01-03 | F&R |                   | TRX 125 J                        | 88    | F   |
|                  | Z 50 R 'All models'                   | 79-86 | F&R |                   | XL 125 K3/K4                     | 79    | F   |
|                  |                                       |       |     |                   | XL 125 L Paris-Dakar             | 85    | R   |
| <b>H302</b>      | <b>HONDA</b>                          |       |     |                   | ATC 125 ME/MG                    | 84-85 | F   |
| 06430 GE8 405    | NB 50 ME 'Aero'                       | 82    | R   |                   | ATC 185 A/SB                     | 80-81 | F   |
| 06430 187 003    | NB 50 MF/MG/TH 'Vision'               | 86-88 | R   |                   | ATC 200 B/ESE/ESF/SE             | 81-84 | F   |
| 06430 GA7 405    | NE 50 MF/MG 'Vision'                  | 86-87 | R   |                   | XL 200 L/R                       | 85    | R   |
| 06430 GE8 003    | NC 50 C 'Express 2'                   | 82    | R   |                   | <b>CPI</b>                       |       |     |
| 06430 GE8 405    | NC 50 A/B 'Express 3 Delux'           | 82    | R   |                   | 50 Hussar                        | 01    | R   |
| 43120 187 003    | ND 50 C/ML 'Melody 2 Delux'           | 82    | R   |                   | 50 Mars                          | 01    | R   |
| 43120 187 005    | NH 50 "Lead 50 SS"                    | 84    | R   |                   | <b>E-TON QUADS</b>               |       |     |
| 43120 187 009    | NH 50 "Lead AF01/D716"                | 84-85 | R   |                   | CXL 150 Challenger               | 02-07 | F   |
| 43120 GA6 003    | NP 50 D 'Melody Mini'                 | 83    | R   |                   | RXL 150 Viper R                  | 05    | F   |
| 43120 GA6 005    | NS 50 'Melody'                        | 82    | R   |                   | RXL 150 Viper                    | 07    | F   |
| 43120 GA7 003    | NU 50 MC 'Runaway'                    | 82    | R   |                   | RXL 150 Yukon                    | 00-02 | F   |
| 43120 GA7 005    | NV 50 MSD 'Stream'                    | 84    | F&R |                   | <b>KM</b>                        |       |     |
| 43120 GA7 305    | NX 50 A/B/MB 'Caren'                  | 80-82 | R   |                   | Badboy 50/100 CX                 | 05    | R   |
| 43120 GE8 003    | NH 80 MD-D/MD-G                       | 83-86 | R   |                   | <b>MOTO ROMA</b>                 |       |     |
| 43120 GE8 405    | NH 80 Lead 80                         | 85    | R   | 45120 101 000     | Wasp 50                          | 99-03 | F   |
| 43120 GA8 003    | PX 50                                 | 82-83 | R   |                   | <b>PEUGEOT</b>                   |       |     |
| 43120 GC8 003    | QR 50 D/E/F                           | 83-87 | R   | 725436            | Streetboard/Trekker (All models) | 00-06 | R   |
| 43120 GC8 004    | <b>KYMCO</b> DJ 50 Refind             |       | R   | 727730            | Ludix 50cc One                   | 04-07 | F&R |
| 43120 GC8 005    | <b>QUADZILLA</b> Buzz 50              | 03-06 | R   | 739653            | Ludix Snake 50cc                 | 04-07 | R   |
| 43120 GF8 003    | <b>SYM</b> Fiddle 50                  | 99-05 | R   | 757782            | Ludix Bullet 50cc                | 04    | R   |
| 43120 GC2 003    |                                       |       |     |                   | Ludix Trend 50cc                 | 04-07 | R   |
| 43120 GK1 000    |                                       |       |     |                   | Ludix Elegance 50c               | 04-07 | R   |
|                  |                                       |       |     |                   | Ludix Ambition 125cc             | 04    | R   |
| <b>H303</b>      | <b>HONDA</b>                          |       |     |                   | Ludix Classic (14" wheels)       | 04-05 | F&R |
| 06430 GN2 730    | C 50 (All Models)                     | 75-93 | F&R |                   | Ludix Urban Track                | 06-07 | R   |
| 06430 HF7J20     | C 50 N (Single seat model)            | 95    | F   |                   | Ludix Red Zone                   | 06    | R   |
| 06430 KEE 630    | C 50 P/S/V/X/Y/1/2                    | 96-02 | F   |                   | Ludix Acid                       | 06    | R   |
| 06450 001 405    | CF 50 'Chaly'                         | 79    | F&R |                   | Ludix Blaster                    | 05-07 | R   |
| 06450 096 651    | PK 50 Wallaro All models              | 90-01 | R   |                   | Vivacity 50/100                  | 04-06 | R   |
| 06450 096 652    | SFX 50 S/T/V/X/Y/1                    | 95-04 | R   |                   | Metal X 50                       | 02-03 | R   |
| 06450 178 932    | SGX 50 V/W/X/Y/1                      | 97-03 | R   |                   | SV 50 J (Fromt drum model)       | 91-95 | F&R |
| 06430 GAG 003    | SH 50 E/H/K/M/P/DP 'City Express'     | 85-96 | F   |                   | Elyseo 50/100                    | 98-02 | R   |
| 06430 KS3 921    | SH 50 T 'Fifty/Scoopy W/X/Y/1'        | 97-03 | R   |                   | SV 50/80/125                     | 91-95 | R   |
| 06450 096 405    | SJ 50 P/R/S/T/V/W/X 'Bali'            | 93-99 | R   |                   | Buxy/M/RM                        | 94-97 | R   |
| 06450 968 681    | SRX 50 T/W/X Joker/Shadow             | 97-99 | R   |                   | Speed Fight (50/100) A/C         | 97-07 | R   |
| 06450 GAG 003    | SS 50 ZK2                             | 75-77 | F&R |                   | Speedake                         | 95-97 | R   |
| 06450 GBY 911    | SS 50 ZB2                             | 77-80 | R   |                   | Squab                            | 95-97 | R   |
| 43120 383 900    | ST 50 'Dax' J/K                       | 78-93 | F&R |                   | Zenith LS                        | 96-99 | R   |
| 43120 GB0 900    | SXR 50 W/S/X/SX                       | 98-99 | R   |                   | Zenith M/N                       | 96-00 | F&R |
| 43120 KB1 910    | TC 50 M/P/V "Gyro Canopy"             | 96-00 | F   |                   | Vivacity 50/100 (All models)     | 99-07 | R   |
| 43120 KG1 920    | C 70 (All models)                     | 75-85 | F&R |                   | LOOXOR 50                        | 01-05 | R   |
| 43120 KG8 003    | CF 70/C                               | 77-78 | F&R |                   | SV 100 L                         |       | R   |
| 43120 KG8 005    | NF 75                                 | 79    | F&R |                   | Fox/Fox L 50                     | 94-98 | F&R |
| 43120 KG8 006    | SA 75 Vision                          | 89-   | F   |                   | TKR (All)                        | 06-07 | R   |
| 43120 KS8 901    | SH 75 Scoopy H/K/M/P/DP/S/DS          | 87-95 | F   |                   | <b>KYMCO</b>                     |       |     |
| 43120 KS8 921    | XR 75 K4                              | 75-78 | R   |                   | Agility 50                       | 05-07 | R   |
| 43120 KS3 901    | XR 75 K5                              | 79    | F&R | 45120 E60 000     | Bet & Win 50/Dink Sports 50      | 02-06 | R   |
| 43120 KS3 921    | NH 80 MD-D/MD-G                       | 83-86 | F   | 45120 096 6520 M2 | Calypso 50/125                   | 99    | R   |
| 43120 KV7 671    | NH 80 MDR                             | 94-   | F   | 43121 A F01 000   | Super 9 (A/C)                    | 00-07 | R   |
| 43120 178 932    | NH 80 Lead 80                         | 85    | R   | 45120 GC8 000     | Cobra Racer                      | 00-06 | R   |
| 45110 GJ3 604    | C 90 (All models)                     | 75-92 | F&R | 43120 KXC 9000    | Cobra 50 Cross                   | 00-06 | R   |
| 45120 096 651    | EZ 90 'Cub'                           | 91-95 | F&R | 4312A LAB4 90B    | Cobra 100 Racer                  | 99-03 | R   |
| 45120 096 652    | NH 90 M/P/R Yuppy                     | 91-94 | R   | 5312A KXCX900     | Fever ZX 50/Scout                | 99-03 | R   |
| 45120 096 653    | SRX 90 Shadow T/W/X                   | 97-99 | R   |                   | Dink 50/Spacer 50/Yager 50       | 98-07 | R   |
| 45120 096 654    | TRX 90 Fourtrax/Sportrax (all models) | 93-06 | F   |                   | Dink Classic Euro 2 50           | 03    | R   |
| 45120 001 010/20 | TRX 90 EX                             | 07    | F   |                   | DJW 50 World                     | 95-97 | F   |
| 45120 107 000    | Astrea Supra NF100                    | 99    | R   |                   | DJX 50                           | 91-92 | F   |
| 45120 383 900    | Astrea Grand/Supra                    | 97-98 | F&R |                   |                                  |       |     |
| 45120 968 681    | H 100 A/SD/SG/SJ                      | 82-92 | F&R |                   |                                  |       |     |

| Part No.      | Make/Model                       | Year  |     | Part No.       | Make/Model                            | Year  |     |
|---------------|----------------------------------|-------|-----|----------------|---------------------------------------|-------|-----|
| <b>H303</b>   | <b>KYMCO Contd.</b>              |       |     | <b>H304</b>    | <b>HONDA Contd.</b>                   |       |     |
|               | DJY 50 Refined                   | 93-06 | F   |                | CT 110 K/M/P                          | 89-93 | R   |
|               | K12 Sport 50                     | 95-00 | R   |                | CT 110 X                              |       | F   |
|               | KB 50                            | 95-00 | R   |                | CB 125 J                              | 79    | R   |
|               | Sniper 50                        | 93    | R   |                | CBX 125 Custom                        | 88-   | R   |
|               | CX 50                            | 93    | F   |                | CG 125 S/T/W/M1                       | 98-02 | R   |
|               | Heroism 50                       | 95-97 | R   |                | CLR 125 W 'City Fly'                  | 98-02 | R   |
|               | Grand King 125/150               |       | F&R |                | CLR 125 X/W/Y                         | 99-   | R   |
|               | Filly 50                         | 98-00 | F&R |                | CR 125 M2/M4                          | 76-78 | F&R |
|               | Filly LX 50                      | 00-06 | R   |                | CT 125 C                              | 85    | F&R |
|               | KB 50 Scout                      | 97    | R   |                | MBX 125 FE                            | 84-86 | R   |
|               | Looping 50                       | 98    | R   |                | MTX 125 RWD                           | 83-84 | F&R |
|               | MXU 50                           | 05-06 | F   |                | MTX 125 RWE/RWF/RWH/RWL               | 85-95 | R   |
|               | Mxer 50/150 (Quad)               | 00-07 | F   |                | SL 125 K1D/E/F/G/K2A                  | 76-80 | F&R |
|               | Spacer 50                        | 99-06 | R   |                | TL 125                                | 76    | F&R |
|               | Top Boy 50                       | 97-06 | R   |                | XL 125 K2                             | 78    | F&R |
|               | Vitality 50 (2T&4T)              | 04-07 | R   |                | XL 125 K3/K4                          | 79    | R   |
|               | Yager 50                         | 07    | R   |                | XL 125 SZ/SA/SB/SC/RC                 | 79-82 | F&R |
|               | Agility 50 Basic                 | 07    | F&R |                | XL 125 RF/RH                          | 85-86 | R   |
|               | Yup 50                           | 01-07 | R   |                | XLR 125 RW                            | 98-99 | R   |
|               | ZX 50 Super Fever/Scout          | 99-06 | R   |                | XR 125 L3/L4/L5/L6/L7                 | 03-07 | R   |
|               | Cobra 100 Racer                  | 99-03 | R   |                | CRF 150 F3/F4/F5/F6/F7                | 03-07 | R   |
|               | KB 100 Manboy                    | 97-00 | R   |                | XL 185 SZ/SA/SB                       | 80-82 | F&R |
|               | Top Boy 100                      | 97    | R   |                | CTX 200/CTA 200 A Bushlander          | 04-05 | R   |
|               | Activ 50/110/125                 | 04-06 | R   |                | MTX 200 RWD                           | 83-84 | F&R |
|               | Agility 125                      | 06-07 | R   |                | MTX 200 RWF                           | 85    | R   |
|               | Heroism 125                      | 95-99 | R   |                | TL 200 J/Y 'Colin Seeley'             | 76-78 | F&R |
|               | Mxer 50/150 Quad                 | 02-07 | F   |                | TLR 200 G/H                           | 86-87 | F   |
|               | Vitality Cross                   | 07    | R   |                | XR 200 R                              | 81-02 | F&R |
|               | Vitality Sports                  | 07    | R   |                | XR 200                                | 80-84 | F&R |
|               | <b>LIFAN</b>                     |       |     |                | CRF 230 F4/F5/F6/F7                   | 04-06 | R   |
|               | LF 50 QGY                        |       | R   |                | CBX 250                               | 84-98 | R   |
|               | LF 50 QGY 1/2                    |       | F&R |                | RTL 250 SG                            | 86    | F&R |
|               | <b>SYM Red Devil</b>             | 99-05 | R   |                | TL 250 K1                             | 79    | F&R |
|               | Cinderella 50/100                | 99-00 | R   |                | TLM 250 RJ                            | 89    | F&R |
|               | Jungle 50                        | 99-02 | R   |                | TLR 250 F                             | 85    | F&R |
|               | Jet 50/Euro XS                   | 99-05 | R   |                | XR 250 RE/RF/RG/RH/RJ/RK              | 84-89 | R   |
|               | Jet 50 Basix 50                  | 06-07 | R   |                | XR 350 RD/RE                          | 83-84 | R   |
|               | Jet Euro X 50/100                | 06-07 | R   |                | XR 500 RD/RE                          | 84-85 | R   |
|               | Mio 50/100                       | 05-07 | R   |                | XR 600 RF/RG/RH/RJ/RK/RL              | 85-90 | R   |
|               | Fiddle 50                        | 99-05 | F   |                | <b>HARTFORD</b>                       |       |     |
|               | City Hopper 50                   | 99-02 | R   |                | VR 125 Z Velo Sport                   | 00-03 | R   |
|               | Mask 50                          | 00-05 | R   |                | VR 125 X/H Velo Cross                 | 00-03 | R   |
|               | Super Fancy 50                   | 96-02 | R   |                | <b>HONDA HM (ITALY)</b>               |       |     |
|               | Jet 100 (G100P-6)                | 99-00 | R   |                | CRF 230 F Easy Trial (All models)     | 04-07 | R   |
|               |                                  |       |     |                | <b>LIFAN</b>                          |       |     |
|               |                                  |       |     |                | LF 50 QGY                             |       | R   |
|               |                                  |       |     |                | LF 50 QGY 1/2                         |       | F&R |
|               |                                  |       |     |                | Smart 50/125                          |       | R   |
|               |                                  |       |     |                | LF 100 A                              |       | R   |
| <b>H304</b>   | <b>HONDA</b>                     |       |     | <b>H305</b>    | <b>use H333</b>                       |       |     |
| 06430 GBJ J10 | C 50 N (Single seat model)       | 95    | R   |                |                                       |       |     |
| 06430 GCE 900 | C 50 P/S/V/X/Y/1/2 (Single seat) | 96-02 | R   |                |                                       |       |     |
| 06430 KK0 405 | CB 50 J                          | 81    | R   |                |                                       |       |     |
| 06430 365 305 | CD 50 ST/SV/SW/SX Benley 50 S    | 96-99 | F&R |                |                                       |       |     |
| 06430 365 306 | CL 50 V/X Benley CL50            | 97-99 | R   |                |                                       |       |     |
| 06430 365 405 | CRM 50 RN/RP/RR/RT               | 93-96 | R   |                |                                       |       |     |
| 06430 365 674 | MB 5 S                           | 80-82 | R   |                |                                       |       |     |
| 06430 MN1 671 | MBX 50 SD/SF                     | 83-85 | R   |                |                                       |       |     |
| 06430 KB9 005 | MG 50 S/X/1/3 Magna 50           | 95-03 | R   | <b>H306</b>    | <b>HONDA</b>                          |       |     |
| 06430 KT0 305 | MP 50 3/DX3 (AC17) Solo          | 03    | F&R | 06430 968 681  | TRX 90 Fourtrax/Sportrax (All models) | 93-06 | R   |
| 06450 121 630 | MRX 50                           | 88-   | R   | 06430 HF1 911  | TRX 90 EX                             | 07    | R   |
| 06450 121 730 | MT 50 SA/SE/SG/SJ/SL             | 80-93 | F&R | 06430 HF7 A30  | ATC 110 (All models)                  | 79-84 | R   |
| 43120 110 670 | MTX 50 SC                        | 83-84 | F&R | 43120 283 010  | TRX 125 J                             | 88    | R   |
| 43120 121 751 | NSR 50 FP/FR/FS                  | 93-95 | R   | 43120 942 000  | ATC 125 ME/MG                         | 84-85 | R   |
| 43120 167 892 | NSR 50 SK/SP/SR/SS               | 89-95 | R   | 43120 961 000  | Wolf 125/150 Scooter                  | 00    | F   |
| 43120 331 670 | TC 50 Y/2 Gyro Canopy            | 00-02 | F   | 43120 961 010  | CD 175 (All models)                   | 71-78 | F   |
| 43120 331 671 | XZ 50 1/2 APE-AC16               | 01-02 | F&R | 43120 968 405  | ATC 185 A/SB                          | 80-81 | R   |
| 43120 365 671 | CRM 75 RK/RL/RM/RP/RR            | 89-94 | R   | 43120 968 681  | ATC 200 B/ESE/ESF/SE                  | 81-84 | R   |
| 43120 365 672 | XR 75 K4                         | 75-78 | F&R | 43120 968 682  | TRX 200 L/M/DM/DN                     | 90-93 | R   |
| 43120 365 673 | CR 80 RA/RB                      | 80-81 | F&R | 45120 230 000  | ATC 250 RB/RC                         | 81-82 | R   |
| 43120 365 647 | CR 80 RC                         | 82    | F   | 45120 303 690  | ATC 250 ESF/ESG/ESH/ESJ               | 85-88 | F   |
| 43120 365 307 | CR 80 R2F/R2G                    | 85-86 | F&R | 45120 HA0 003  | FL 250 Odyssey                        | 77-84 | R   |
| 43120 KB9 005 | MB 80 (MB8)                      | 80-   | R   | 45120 HA0 006  | <b>POLARIS</b>                        |       |     |
| 43120 KB9 015 | MBX 80 FWDD/FEDF                 | 83-86 | R   |                | Phoenix 200                           | 05    | R   |
| 43120 KF0 005 | MCX 80                           | 82-   | R   |                |                                       |       |     |
| 43120 MN1 641 | MTX 80 RFD/RFF                   | 83-84 | F&R | <b>H307</b>    | <b>HONDA</b>                          |       |     |
| 43120 MN1 642 | NSR 80                           | 86    | R   | 0450434        | Wolf 125/150 Scooter                  | 00    | R   |
| 43120 MN1 643 | XR 80 Z/A/B                      | 80-81 | F&R | 43120 230 000  | CD 175 (All models)                   | 71-78 | R   |
| 43120 MN1 671 | C 90 All models                  | 93-03 | F&R | 43120 303 690  | <b>ARCTIC CAT</b>                     |       |     |
| 431A2 365 672 | CB 100 N                         | 78-80 | R   | 43120 303 305  | 50 Y-6 Youths (2x4)                   | 04-05 | F   |
| 45120 365 671 | XL 100 (All Models)              | 78-82 | F&R | 4312A B06 000  | 90 Y-12 Youths (2T & 4T Models)       | 02-05 | F   |
| 45120 365 672 | XZ 100 2 APE-HC07                | 02    | F&R | 3301-183       | <b>KYMCO</b>                          |       |     |
| 45120 365 673 |                                  |       |     | 4312A LBD4 900 | Maxxer 50                             | 05-06 | R   |
| 45120 KB9 005 |                                  |       |     |                | <b>POLARIS</b>                        |       |     |
| 45120 KB9 015 |                                  |       |     |                |                                       |       |     |
| 45120 KK0 005 |                                  |       |     |                |                                       |       |     |
| 451A2 KK0 305 |                                  |       |     |                |                                       |       |     |

| Part No.  | Make/Model  | Year   |   | Part No.   | Make/Model  | Year   |   |
|---|---|--|---|--|---|--|---|
| <b>H307</b>   | <b>POLARIS Contd.</b><br>Predator 50 (2 stroke)<br>Scrambler 50<br>Predator 90<br>Scrambler 90/90 X<br>Sportsman 90<br><b>ROXON</b><br>Fox 50 (Quad)<br><b>SYM</b><br>125 Attila<br>Super Duke 125/150<br>KXR 50/90 Mongoose  | 04<br>01-03<br>03-04<br>01-03<br>01-04   | R<br>R<br>R<br>R<br>R   | <b>H315</b><br>06430 HC4 901<br>06430 HC4 671<br>43120 286 000<br>43120 369 670<br>43120 HC4 671<br>43120 HC4 405<br>43120 KC4 000<br>43120 KG4 003<br>43120 KG4 006<br>431A2 KG4 006  | <b>HONDA</b><br>ATC 250 ESF/ESG/ESH/ESJ<br>CB 250 K3-K5<br>CB 250 G5<br>CJ 250 T<br>MXV 250 F (MC92)<br>TRX 250 F/G/H<br>TRX 300 FWJ/K/L/T/V/W/X/Y<br>TRX 300 J/K/L/T/V/W/X<br>CB 350 K4<br>CB 360 G5<br>CJ 360 T<br>CB 400 F/F1/F2   | 85-88<br>73-75<br>75<br>77<br>83-88<br>85-87<br>88-00<br>88-99<br>74<br>75<br>78<br>75-79                                | R<br>R<br>R<br>R<br>R<br>R<br>R<br>R<br>R<br>R<br>R           |
| <b>H308</b><br>45120 235 000<br>45120 354 670   | <b>HONDA</b><br>CB 125 K1 to K5<br>CB 175 (All models)  | 72-76<br>74-76   | F<br>F  | <b>H316</b><br>43120 216 000<br>43120 216 670<br>43120 283 000<br>43120 458 670<br>43120 283 670<br>43120 404 003<br>43120 458 305<br>43120 485 670  | <b>HONDA</b><br>CB 500 T<br>CB 500 K1/K2/F<br>CB 550 F/F1/F2/K3   | 75-77<br>75-77<br>78-80  | R<br>R<br>R   |
| <b>H309</b><br>06430 354 405<br>43120 354 405<br>43120 354 670<br>43120 473 003<br>431A2 354 670<br>45120 240 000<br>45120 240 010<br>06430 354 670<br>43120 354 405<br>43120 354 670<br>43120 473 003<br>431A2 354 670<br>45120 240 000<br>45120 240 010 | <b>HONDA</b><br>CB 175 (All models)<br>CB 200 B<br>CB 250 RSA/RSD<br>CL 250 SC<br>CBR 250 FG/FGYA (MC14)<br>VT 250 FD<br>VTZ 250 H/J/K<br>XL 500 SB   | 74-76<br>76-79<br>81-84<br>81<br>86<br>83<br>86-88<br>81   | R<br>R<br>R<br>R<br>R<br>R<br>R<br>R                          | <b>H318</b><br>06430 429 000<br>06430 429 405<br>06430 GBJ 740<br>06430 GBJ 742<br>06430 GBJ K20<br>06430 MMG 780<br>43120 429 000<br>43120 429 010<br>43120 429 405<br>43120 MM9 600<br>43120 MM9 780<br>43120 MM9 781<br>431A2 429 010 | <b>HONDA</b><br>CA 125 S/T/V/W/X/1<br>CBX 125 F<br>NES 125 Y (@ 125 Scooter)<br>VT 125 CX/CY/C1/C21/C3<br>/C4/C7 'Shadow'<br>XL 250 SB<br>CBX 250 RSE<br>CMX 250 CT/CV/CW/CX 'Rebel'<br>GB 250 E/H Clubman<br>GB 250 J/L/P/S/V "Clubman"<br>XL 500 SZ<br>XL 500 RC<br>XR 500 SZ/SA<br>XR 500 RB<br>XL 600 RD/LD/RE/LE/RF/RG/RH<br>XL 600 LM-F<br>XL 600 VH/VJ/VK 'Transalp' | 95-01<br>84-<br>00-01<br>99-07<br>82<br>84<br>96-00<br>84-87<br>88-97<br>80<br>82<br>79-80<br>81<br>83-87<br>85<br>87-90 | R<br>R<br>R<br>R<br>R<br>R<br>R<br>R<br>R<br>R<br>R<br>R<br>R |
| <b>H310</b><br>06430 KC1 690<br>06430 KC1 750<br>06430 362 000<br>06430 362 405<br>06430 KBG 702<br>06430 KEW 900<br>43120 240 000<br>43120 240 670<br>43120 362 000<br>43120 362 405<br>43120 362 670<br>43120 957 000<br>43120 957 305<br>431A2 362 000 | <b>HONDA</b><br>ATC 70 (All models)<br>CB 125 K1 to K5<br>CB 125 K6/S2<br>CB 125 T/T2<br>CB 125 RS<br>CB 125 TDC/TDE/TDJ<br>CBX 125 TS Custom<br>CD 125 TC<br>CM 125 CC/CF<br>CD 185 T<br>CD 200 TA/TB<br>CM 200 TA/TB<br>CD 250 UJ<br>CB 250 N/T/W/X/Y/1/4 'Two fifty' | 78-85<br>72-76<br>76<br>78-79<br>83<br>83-89<br>82-<br>78<br>82-85<br>78<br>79-80<br>79-80<br>89-92<br>92-05 | R<br>R<br>R<br>R<br>R<br>R<br>R<br>R<br>R<br>R<br>R<br>R<br>R | <b>H319</b><br>43120 KA4 003<br>43120 KA4 005  | <b>HONDA</b><br>CR 125 RC<br>CR 450 RB  | 82<br>81   | F<br>R  |
| <b>H311</b><br>45120 329 000<br>45120 329 670   | <b>HONDA</b><br>XL 250 K3/K4  | 78-79  | F   | <b>H320</b><br>43120 300 010<br>43120 393 003<br>43120 393 006<br>43120 393 305<br>431A2 393 006   | <b>HONDA</b><br>CB 650 Z/B<br>CB 650 SCC 'Night Hawk'<br>CB 750 K0-K6<br>CB 750 K7<br>CB 750 KZ   | 79-81<br>82<br>69-77<br>78<br>80   | R<br>R<br>R<br>R<br>R   |
| <b>H312</b><br>06430 329 305<br>06430 329 670<br>06450 KBG 000<br>06450 KC2 681<br>43120 329 000<br>43120 329 306<br>43120 329 670<br>45120 473 003<br>45120 473 006  | <b>HONDA</b><br>CD 125 TC<br>CM 125 CC/CF<br>CD 185 T<br>CD 200 TA/TB<br>CM 200 TA/TB<br>CL 250 SC<br>XL 250 S/SZ/SA/SB<br>XR 250 SZ/SA<br>XL 250 K3/K4<br>XL 500 SZ  | 78<br>82-85<br>78<br>79-80<br>79-80<br>81<br>78-82<br>79-80<br>78-79<br>80                                   | F<br>F<br>F<br>F<br>F<br>F<br>F<br>R<br>R<br>F                | <b>H321</b><br>06430 415 000<br>06430 MR1 611<br>06430 MW3 671<br>43120 415 000<br>43120 MW3 671<br>431A2 415 006<br>43120 KED9 900  | <b>HONDA</b><br>VT 250 CR/CT/CV "Magna"<br>NV 400 CJ/CK "Steed"<br>NV 400 CS/CV Steed<br>CB 450 SG/SJ<br>CB 500 R/T<br>CX 500 CA/CB/Z/A/B<br>CX 500 CC<br>GL 500 DC<br>VT 600 CN/CR/CS/CT/CV/CW<br>Shadow Custom<br>GL 650 D2-E<br>VF 750 SC<br>VF 750 S "Sabre"<br><b>KYMCO</b><br>Venox 250 (RA 50 AA)  | 95-97<br>92-93<br>95-97<br>86-88<br>94-96<br>79-81<br>82<br>82<br>93-99<br>84<br>82<br>82-83<br>00-06                    | R<br>R<br>R<br>R<br>R<br>R<br>R<br>R<br>R<br>R<br>R<br>R      |
| <b>H313</b><br>06430 413 405<br>43120 413 000<br>43120 413 003<br>43120 413 006<br>43120 413 405<br>431A2 413 006   | <b>HONDA</b><br>CB 250 T/N/NA/NB/ND/NDB/NDC<br>CM 250 TB<br>CB 350 SG/SJ<br>CB 400 A 'Honda-matic'<br>CB 400 T<br>CB 400 N/NA/NB/NC<br>CMX 450 CH/CJ Rebel<br>VT 500 ED/EF  | 78-82<br>81<br>86-90<br>79<br>78<br>78-82<br>87-88<br>83-85  | R<br>R<br>R<br>R<br>R<br>R<br>R<br>R                          | <b>H322</b><br>450-09-030-000<br>45120 GE8 003<br>45120 GE8 505<br>43120 GZ9 003<br>45120 093 003<br>43120 148 305<br>43120 148 670<br>43120 KED9 900<br>45130 148 670<br>752789<br>NY1-W2534-00<br>45009 035 000                        | <b>HONDA</b><br>PA 50 'Camino'<br>PF 50 M 'Novio'<br>PX 50<br><b>KREIDLER</b><br>50 MF2<br>50 MF4 later models<br>50 Flory MF 20/22<br>50 MP1 later models  | 80<br>75<br>82-84  | F&R<br>F&R<br>F<br>F&R<br>F&R<br>F&R<br>F&R                   |
| <b>H314</b><br>45120 286 000<br>45120 369 670<br>45120 369 305  | <b>HONDA</b><br>CB 250 K3-K5<br>CB 350 K4   | 73-75<br>74  | F<br>F  |  |   |  |   |



| Part No.                     | Make/Model                             | Year  |               | Part No.                     | Make/Model                              | Year         |       |     |
|------------------------------|--|-------|---------------|------------------------------|---|--------------|-------|-----|
| <b>H322</b><br><b>Contd.</b> | <b>KTM</b>                             |       |               | <b>H330</b><br><b>Contd.</b> | <b>E-TON Contd.</b>                     |              |       |     |
|                              | 50 SX/SXR Pro Junior/Senior /Adventure | 96-03 | F&R           |                              | Viper EXL 150 ST Quad                   | 05-07        | R     |     |
|                              | 50 SX Mini Adventure                   | 04-07 | F&R           |                              | EXL 150 Yukon ST                        | 05-07        | R     |     |
|                              | 50 SX Pro Senior LC                    | 02-03 | R             |                              | <b>BOMBARDIER</b>                       |              |       |     |
|                              | 50 SX Pro Senior LC                    | 02-07 | R             |                              | DS 50 (2 stroke)                        | 02-04        | R     |     |
|                              | 50 SX Mini Senior Adventure            | 02-07 | R             |                              | Quest 50                                | 03-04        | R     |     |
|                              | <b>MOTOBECANE</b>                      |       |               |                              | DS 90 (2 stroke/4 stroke)               | 02-04        | R     |     |
|                              | 50 all mod. Atom hub                   | 88-   | F             |                              | Quest 90 (2 stroke/4 stroke)            | 03-04        | R     |     |
|                              | 50 all mod. Leleu hub                  | 88-   | F             |                              |   |              |       |     |
|                              | 51 VLM                                 |       | R             |                              | <b>H331</b>                             | <b>HONDA</b> |       |     |
|                              | <b>PEUGEOT</b>                         |       |               |                              | 43120 KA3 305                           | CR 125 RD    | 83    | F&R |
|                              | Most Mofas/Mopeds                      |       | F&R           |                              | 43120 KA3 711                           | CR 125 RE/RF | 84-85 | R   |
| 103 Pro, SP 3                |  | F&R   | 43120 KA3 731 | CR 250 RD/RE/RF              | 83-85                                   | R            |       |     |
| <b>PUCH</b>                  |  |       | 43120 KA3 732 | XR 350 RD                    | 83                                      | F            |       |     |
| Maxi (Spoke wheels)          | All                                    | F&R   | 43120 KA3 831 | CR 480 RD                    | 83                                      | R            |       |     |
| Monza 4 SL/GP                |  | F&R   | 43120 KA3 832 | CR 500 RE/RF                 | 84-85                                   | R            |       |     |
| Imola X/GX                   |  | R     | 45120 KA4 711 |                              |   |              |       |     |
| Cobra 80/80-6/80-6 GT/GTL    |  | R     | 45120 KA4 712 | <b>H332</b>                  | <b>HONDA</b>                            |              |       |     |
|                              |  |       |               | 45120 MC4 005                | XL 500 RC                               | 82           | F     |     |
|                              |  |       |               | 45120 MC4 405                |   |              |       |     |
|                              |  |       |               | 06450 MC4 415                |   |              |       |     |
| <b>H323</b>                  | <b>HONDA</b>                           |       |               | <b>H333</b>                  | <b>HONDA</b>                            |              |       |     |
| 06430 KBR 003                | NX 250 J/K/L/M/P/2P                    | 87-93 | R             | 06430 GCW 000                | CHF 50-1/Scoopy 50                      | 01-05        | F&R   |     |
| 06430 428 003                | XL 250 Degree (MD26)                   |       | R             | 06430 GE1 405                | SA 50 J/M/P/R/S 'Vision Met-in'         | 88-95        | F&R   |     |
| 43120 428 003                | XL 250 S/SZ/SA                         | 78-81 | R             | 06430 GE1 670                | CR 50 RE/RF                             | 84-85        | F&R   |     |
| 43120 428 005                | XL 250 RC                              | 82    | R             | 06430 GE1 671                | NJ 50 MDY/M2/MD2 Gyro-X                 | 00-02        | F&R   |     |
| 43120 428 013                | XL 250 RE/RF                           | 84-85 | R             | 06430 GET 000                | NU 50 MC 'Runaway'                      | 82           | F     |     |
| 43120 428 015                | XLR 250 Baja MK1 (MD22)                |       | R             | 06430 GCW 000                | NPC 50 2/3 (AF59) Bite                  | 02-03        | F&R   |     |
| 43120 428 405                | XR 250 SZ/SA                           | 79-80 | R             | 06430 GY1 922                | NPS 50 1/2/3/5/6/7 (AF58) Zoomer        | 01-07        | F&R   |     |
| 43120 KW3 611                | XR 250 RB/RC/RD                        | 81-83 | R             | 06430 GN1 730                | NVS 50 1SH2 Today 50                    | 01-05        | F     |     |
| 43120 KW3 612                |  |       |               | 06430 GC4 405                | PK 50 Wallaro All models                | 90-01        | F     |     |
| 431A2 428 013                |  |       |               | 06450 KJ2 405                | SK 50 MM/MM-YA/MM-YC                    |              |       |     |
|                              |  |       |               | 06450 KJ2 305                | /MN/MN-YA/MN-YB/MP                      |              |       |     |
|                              |  |       |               | 06450 GT8 B41                | /MP-YA/MMR/MMR (AF27) Dio               |              | F&R   |     |
|                              |  |       |               | 06450 GT8 B40                | SK 50 MM-II/MM-YD/MN-II                 |              |       |     |
|                              |  |       |               | 43120 GC4 003                | /MPLI (AF28) Dio SR                     |              | R     |     |
|                              |  |       |               | 43120 GC4 005                | SK 50 MN-III/MP-III/MP-IV (AF28) Dio-ZX |              | R     |     |
|                              |  |       |               | 43120 GC4 006                | SK 50 MMR-II/MMT (AF28) Dio XR          |              | R     |     |
|                              |  |       |               | 43120 GE1 671                | SN 50 N/R/S "Giorno"                    | 94           | F&R   |     |
|                              |  |       |               | 43120 GM9 003                | Tact 50                                 |              | R     |     |
|                              |  |       |               | 43120 GM9 711                | TC 50 M/P/V "Gyro Canopy"               | 96-00        | R     |     |
|                              |  |       |               | 43120 GY1 921                | TC 50 Y/2 Gyro Canopy                   | 00-02        | R     |     |
|                              |  |       |               | 43120 KJ2 003                | TLM 50 F                                | 85           | F&R   |     |
|                              |  |       |               | 43120 KJ2 004                | QR 50 M/R/V/W/Y                         | 93-03        | R     |     |
|                              |  |       |               | 431A2 KJ2 004                | CR 60 RF/RF                             | 85-86        | F&R   |     |
|                              |  |       |               | 45120 GC1 003                | CRF 70 F4/F5/F6/F7                      | 04-07        | F&R   |     |
|                              |  |       |               | 45120 GC1 006                | XR 70 RV/RW/RX/RV/R1/R2/R3              | 97-03        | F&R   |     |
|                              |  |       |               | 45120 GC2 003                | SA 75 Vision                            | 89-          | R     |     |
|                              |  |       |               | 45120 GC2 004                | CR 80 RC                                | 82           | R     |     |
|                              |  |       |               | 45120 GC2 405                | CR 80 RD/RE                             | 83-84        | F&R   |     |
|                              |  |       |               | 45120 GY1 921                | CR 80 RF                                | 85           | F     |     |
|                              |  |       |               | 45120 GY1 922                | CRF 80 F4/F5/F6/F7                      | 04-07        | F&R   |     |
|                              |  |       |               | 45120 KJ2 000                | XR 80 R                                 | 87-88        | F&R   |     |
|                              |  |       |               | 45120 KJ2 003                | NH 80 MDR                               | 94-          | R     |     |
|                              |  |       |               | 45120 KJ2 004                | NH 80 Lead 80 SS                        | 85           |       |     |
|                              |  |       |               | 451A2 KJ2 003                | Lead 90                                 | 88-          | R     |     |
|                              |  |       |               | 43120 KJ2 405                | CRF 100 R4/R5/R6/R7                     | 04-07        | F&R   |     |
|                              |  |       |               | 43120 GY1 922                | XR 100 RP/RR/RS/RT/RV/RW/RX/RV/R1-R3    | 93-03        | F&R   |     |
|                              |  |       |               | 43120 GE1 6720 M1            | TLR 200 D/E                             | 83-85        | F&R   |     |
|                              |  |       |               | 43128 KC 9000                | TLR 200 G/H                             | 86-87        | R     |     |
|                              |  |       |               | 43120 E22 000                | <b>KYMCO</b>                            |              |       |     |
|                              |  |       |               | 4312A E22 000                | CX 50                                   | 93           | R     |     |
|                              |  |       |               |                              | CX 50 Super                             | 94-97        | R     |     |
|                              |  |       |               |                              | DJW 50 World                            | 94-00        | R     |     |
|                              |  |       |               |                              | DJX 50                                  | 91-92        | R     |     |
|                              |  |       |               |                              | DJY 50 Refined                          | 93-06        | R     |     |
|                              |  |       |               |                              | <b>SYM</b>                              |              |       |     |
|                              |  |       |               |                              | DD 50 City Trek                         | 02-07        | R     |     |
|                              |  |       |               |                              |   |              |       |     |
|                              |  |       |               | <b>H334</b>                  | <b>HONDA</b>                            |              |       |     |
|                              |  |       |               | 43120 GE9 003                | PXR 50                                  | 84           | F     |     |
|                              |  |       |               | 43130 GE9 003                |   |              |       |     |
|                              |  |       |               | <b>H335</b>                  | <b>HONDA</b>                            |              |       |     |
|                              |  |       |               | 45120 GB7 305                | PXR 50                                  | 84           | R     |     |
|                              |  |       |               | 45120 GB7 851                |   |              |       |     |
|                              |  |       |               | 45130 GB7 851                |   |              |       |     |
|                              |  |       |               | 45120 GB7 852                |   |              |       |     |
|                              |  |       |               | 45130 GB7 852                |   |              |       |     |



| Part No.  | Make/Model   | Year   |   | Part No.   | Make/Model  | Year   |  |  |  |  |  |       |   |
|---|--|--|---|--|---|--|--|--|--|--|--|-------|---|
| <b>H351 Contd.</b>  | <b>HONDA Contd.</b><br>Rancher 4x4 & 2x4/FEY/1-5<br>CB 400 SS (CB 400 SS2-J<br>/SS2-3J-NC41)<br>TRX 400 FWS/T/V/W/X/Y<br>TRX 400 FA4/5/6/7 Fourtrax AT<br>TRX 400 FGA4/5/6/7 Fourtrax<br>Rancher AT Gscape<br>TRX 420 FET/TE7 Fourtrax<br>Rancher<br>TRX 420 FM7/TM7 Fourtrax<br>Rancher<br>TRX 450 ESW/ESX/ESY/ES1<br><b>PEUGEOT</b><br>SV 250  | 00-05  | R   | <b>K706</b><br>41048 020<br>41048 1058<br>41048 1062<br>41048 1069<br>41048 1142 | <b>KAWASAKI</b><br>KLF 185 A1<br>KLF A1-A10<br>KLF 220 A1-A15<br>BJ 250 E1-E4A Estrella-RS Custom<br>BJ 250 D1-D7 Estrella Custom<br>BJ 250 F1/F2 (250 TR)<br>BJ 250 F1/F2 (250 TR)<br>EL 250 D1-D5<br>EL 250 Eliminator<br>ER 250 B1/B2/B3 (Z 250 T Scorpion)<br>KLF 250 A1/A2/A3/A6F Bayou<br>Z 250 B1/B2<br>EL 252 F2/F5<br>KLF 300 A1/A2/B1-B17 'Bayou'<br>GPZ 305 A1/B1-B10<br>Z 400 B1/B2<br>Z 400 G1<br>ZR 400 A1/B1 (Z 400 F)<br>Z 440 A2/C1<br>Z 440 C2<br>Z 440 D4/D5/D6 (LTD)<br>Z 440 H1/H2<br>GPZ 500 S (EX 500 A1-A6)<br>GPZ 500 S (EX 500 B1-B5)<br>ER-5 (ER 500 A1/A2/A3/A4/C1-C5P)<br>ZR 550 A1/A2 (Z 550 F)<br>W 650 (EJ 650 -A1/C3-C7) | 87   | R  |  |  |  |  |       |   |
|   |  | 01   | R   |  |   | 88-97  | R  |  |  |  |  |       |   |
|   |  | 95-  | R   |  |   | 88-02  | R  |  |  |  |  |       |   |
|   |  | 04-07  | F   |  |   | 96-99  | R  |  |  |  |  |       |   |
|   |  | 04-07  | F   |  |   | 96-02  | R  |  |  |  |  |       |   |
|   |  | 07   | R   |  |   | 92-03  | R  |  |  |  |  |       |   |
|   |  | 07   | R   |  |   | 02   | R  |  |  |  |  |       |   |
|   |  | 07   | R   |  |   | 90-94  | R  |  |  |  |  |       |   |
|   |  | 07   | R   |  |   | 87-89  | R  |  |  |  |  |       |   |
|   |  | 98-01  | R   |  |   | 83-88  | R  |  |  |  |  |       |   |
|   |  | 01-02  | R   |  |   | 80-83  | R  |  |  |  |  |       |   |
| <b>H352</b><br>06430 GBJ K20<br>06430 GBJ K10<br>06430 KG1 900<br>06430 KRP 980<br>06430 KGA 900<br>06430 GCE 930 | <b>HONDA</b><br>SCV 100-3/F5 Lead<br>CT 110 X<br>CG 125-ES4<br>CG 125 Job<br>PS 125i 6/7<br>SH 125 1/3/4/5/6/7<br>NES 125 Y1-5 @ 125 Scooter<br>NXR 125 Bros ES/KS<br>SES 125/150 2/3/4 Dylan<br>CG 150 ESD Titan<br>CG 150 KS/ES Titan<br>NES 150 Y1-5 @ 150 Scooter<br>SH 150 1/3/4/5/6/7<br>CBX 200 Strada<br>FTR 223 Y2/A2 (MC34)<br>XL 230 2 (MC36)<br>CBF 250 4/7<br>CBX 250 Twister<br>XR 250 Tornado | 03-07  | F&R   | <b>K708</b><br>41048 1122<br>42019 003   | <b>KAWASAKI</b><br>250 S1B<br>KH 250 B1-B5<br>KH 400 'All models'   | 75   | R  |  |  |  |  |       |   |
|   |  | 04-07  | R   |  |   | 77-82  | R  |  |  |  |  |       |   |
|   |  | 05   | F   |  |   | 76-81  | R  |  |  |  |  |       |   |
|   |  | 06-07  | R   |  |   | <b>K709</b><br>41048 1059<br>41048 1070<br>42019 012 | <b>KAWASAKI</b><br>ZL 400 A 'Eliminator'<br>ZL 400 B 'Eliminator' 400 SE<br>Z 400 J1/J2/J3<br>LTD 450 (EN 450 A1-A5)<br>EN 500 A1-A3/B1-B2/C1-C9<br>Z 550 A1<br>Z 550 A2/A3/C1/C2/LTD<br>GT 550 G1-G9<br>ZL 600 B1 Eliminator<br>Z 650 B1-B3/F1-F4<br>VN 700 A1 'Vulcan'<br>VN 750 A2-A5/A10<br>Z 750 Y1 (LTD)<br>VN 800 A1/A2/A3<br>VN 800 B1-B10/B6F 'Classic' | 86-87  | R  |  |  |       |   |
|   |  | 01-07  | R   |  |   |  |  | 88   | R  |  |  |       |   |
|   |  | 00-05  | R   |  |   |  |  | 80-83  | R  |  |  |       |   |
|   |  | 05   | F   |  |   |  |  | 86-89  | R  |  |  |       |   |
|   |  | 02-07  | R   |  |   |  |  | 86-89  | R  |  |  |       |   |
|   |  | 04-05  | R   |  |   |  |  | 90-04  | R  |  |  |       |   |
|   |  | 04-05  | R   |  |   |  |  | 80   | R  |  |  |       |   |
|   |  | 01-05  | R   |  |   |  |  | 81-84  | R  |  |  |       |   |
|   |  | 01-07  | R   |  |   |  |  | 83-01  | R  |  |  |       |   |
|   |  | 97-01  | R   |  |   |  |  | 95-97  | R  |  |  |       |   |
|   |  | 00-02  | R   |  |   |  |  | 79-83  | R  |  |  |       |   |
|   |  | 02   | F&R   |  |   |  |  | 85   | R  |  |  |       |   |
|   |  | 04-07  | R   |  |   |  |  | 86-94  | R  |  |  |       |   |
|   |  | 05   | R   |  |   |  |  | 82   | R  |  |  |       |   |
|   |  | <b>H353</b><br>06430 KPH 900                         | <b>HONDA</b><br>ANF 125-3/5/T5/6/7 Innova<br>CG 125 Job<br>NXR 125 Bros ES/KS           |  |   |  |  | 03-07  | R  | <b>K710</b><br>41048 013<br>41048 1071<br>41048 1082<br>41048 1097<br>41048 1127 | <b>KAWASAKI</b><br>H1D/E/F<br>KLF 300 C1-C17 "Bayou"<br>KVF 300 A1-A4 (Prairie 4x4)<br>KVF 300 B1-B4 (Prairie 2x4)<br>KVF 400 C1-C4 (Prairie 4x4)<br>KVF 400 D1-D4 (Prairie 2x4)<br>KLF 400 B1-B7 Bayou<br>KVF 400 A1/A2/B1 'Prairie'<br>KH 500 A8 | 73-75 | R |
| 05  | R  |  |   | 89-05  | R   |  |  |  |  |  |  |       |   |
| 05  | R  |  |   | 99-02  | R   |  |  |  |  |  |  |       |   |
| <b>K701</b><br>41048 1011<br>41048 1021<br>41048 1109   | <b>KAWASAKI</b><br>KX 80 B1/B2/D1/D2   | 79-83  | F&R   | <b>K711</b><br>41048 004<br>41048 019<br>41048 044<br>41048 1014<br>41048 1090   | <b>KAWASAKI</b><br>250 S1B<br>Z 250 B1/B2/C1/C2/G1/G2   |  |  | 75   | F  |  |  |       |   |
|   |  | <b>K702</b><br>41048 1063<br>41048 1097<br>42019 013 | <b>KAWASAKI</b><br>KH 125 A1-A4<br>KX 125 B2/C1/D1<br>KDX 200 A1/A2/A3<br>KDX 200 C1-C3 |  |   | 77-81  | R  | 80-83  | F  |  |  |       |   |
|   |  |  |   |  |   | 83-85  | R  | <b>K713</b><br>41048 012<br>41048 014<br>41048 016<br>41048 1092 | <b>KAWASAKI</b><br>Z 900 Z1A/Z1B<br>Z 900 A4   | 74-76  | R  |       |   |
|   |  |  |   |  |   | 83-85  | R  |  |  | 77   | R  |       |   |
| 86-88   | R  | <b>K714</b><br>41048 1023<br>41048 1102              | <b>KAWASAKI</b><br>KX 80 E1   | 83   | F   |  |  |  |  |  |  |       |   |
| <b>K703</b><br>41048 1012<br>41048 1056<br>41048 1084   | <b>KAWASAKI</b><br>KE 175 D2/D3/D4/D5<br>KDX 200 A1/A2/A3<br>KL 250 A3/A4/C1/C2<br>KLR 250 D2-D22  |  |   | 79-83  | R   | <b>K705</b><br>41048 018<br>41048 1017<br>41048 1068 | <b>KAWASAKI</b><br>KLT 200 C1/C2/A1/A4A<br>KLF 200 A1-A10<br>KLF 220 A1-A15<br>KX 250 (A Series)<br>KDX 250 B1-B3<br>KL 250 A1-A2<br>KLF 250 A1/A2/A3/A6F Bayou<br>KLT 250 C1/C2/C3 'Prairie'<br>KTX 250 A1 'Tecate'<br>KX 420 A1/A2   | 81-84  | R  |  |  |       |   |
|   |  |  |   | 83-85  | F   |  |  | 88-97  | F  |  |  |       |   |
|   |  | 80-84  | R   | 88-02  | F   |  |  |  |  |  |  |       |   |
| <b>K704</b><br>41048 015<br>41048 1015<br>41048 1091  | <b>KAWASAKI</b><br>KE 125 A4-A12<br>KX 125 A3-A7<br>KDX 175 A1-A3<br>KE 175 B1-B3/D2-D5<br>KT 250 (All models)<br>KL 250 A3/A4/C1/C2   | 76-85  | F   | <b>K713</b><br>41048 012<br>41048 014<br>41048 016<br>41048 1092                 | <b>KAWASAKI</b><br>Z 900 Z1A/Z1B<br>Z 900 A4  | 74-76  | R  |  |  |  |  |       |   |
|   |  | 74-80  | F   |  |   | 77   | R  |  |  |  |  |       |   |
|   |  | 80-82  | F   |  |   | <b>K714</b><br>41048 1023<br>41048 1102              | <b>KAWASAKI</b><br>KX 80 E1  | 83   | F  |  |  |       |   |
|   |  | 76-83  | F   |  |   |  |  | <b>K705</b><br>41048 018<br>41048 1017<br>41048 1068             | <b>KAWASAKI</b><br>KLT 200 C1/C2/A1/A4A<br>KLF 200 A1-A10<br>KLF 220 A1-A15<br>KX 250 (A Series)<br>KDX 250 B1-B3<br>KL 250 A1-A2<br>KLF 250 A1/A2/A3/A6F Bayou<br>KLT 250 C1/C2/C3 'Prairie'<br>KTX 250 A1 'Tecate'<br>KX 420 A1/A2 | 81-84  | R  |       |   |
|   |  | 75-80  | F   |  |   |  |  |  |  | 88-97  | F  |       |   |
| 80-84   | F  | 88-02  | F   |  |   |  |  |  |  |  |  |       |   |
| <b>K705</b><br>41048 018<br>41048 1017<br>41048 1068  | <b>KAWASAKI</b><br>KLT 200 C1/C2/A1/A4A<br>KLF 200 A1-A10<br>KLF 220 A1-A15<br>KX 250 (A Series)<br>KDX 250 B1-B3<br>KL 250 A1-A2<br>KLF 250 A1/A2/A3/A6F Bayou<br>KLT 250 C1/C2/C3 'Prairie'<br>KTX 250 A1 'Tecate'<br>KX 420 A1/A2   | 81-84  | R   | <b>K714</b><br>41048 1023<br>41048 1102  | <b>KAWASAKI</b><br>KX 80 E1   | 83   | F  |  |  |  |  |       |   |
|   |  | 88-97  | F   |  |   | <b>K705</b><br>41048 018<br>41048 1017<br>41048 1068 | <b>KAWASAKI</b><br>KLT 200 C1/C2/A1/A4A<br>KLF 200 A1-A10<br>KLF 220 A1-A15<br>KX 250 (A Series)<br>KDX 250 B1-B3<br>KL 250 A1-A2<br>KLF 250 A1/A2/A3/A6F Bayou<br>KLT 250 C1/C2/C3 'Prairie'<br>KTX 250 A1 'Tecate'<br>KX 420 A1/A2   | 88-02  | F  |  |  |       |   |
|   |  | 74-81  | F   |  |   |  |  | 74-76  | R  |  |  |       |   |
|   |  | 79-84  | F   |  |   |  |  | 77   | R  |  |  |       |   |
|   |  | 78-79  | F   |  |   |  |  | <b>K714</b><br>41048 1023<br>41048 1102                          | <b>KAWASAKI</b><br>KX 80 E1  | 83   | F  |       |   |
|   |  | 03-06  | F   |  |   |  |  |  |  | <b>K705</b><br>41048 018<br>41048 1017<br>41048 1068                             | <b>KAWASAKI</b><br>KLT 200 C1/C2/A1/A4A<br>KLF 200 A1-A10<br>KLF 220 A1-A15<br>KX 250 (A Series)<br>KDX 250 B1-B3<br>KL 250 A1-A2<br>KLF 250 A1/A2/A3/A6F Bayou<br>KLT 250 C1/C2/C3 'Prairie'<br>KTX 250 A1 'Tecate'<br>KX 420 A1/A2               | 81-84 | R |
|   |  | 83-85  | R   |  |   |  |  |  |  |  |  | 88-97 | F |
|   |  | 84   | F   |  |   |  |  | 88-02  | F  |  |  |       |   |
|   |  | 80-81  | F   |  |   |  |  | 74-81  | F  |  |  |       |   |









| Part No.           | Make/Model                            | Year  |     | Part No.          | Make/Model                 | Year  |     |
|--------------------|---------------------------------------|-------|-----|-------------------|----------------------------|-------|-----|
| <b>Y503 Contd.</b> | <b>YAMAHA Contd.</b>                  |       |     | <b>Y503 Cont.</b> | <b>MBK Contd.</b>          |       |     |
|                    | YFM 80 WP/WR/WVS/RT/RV                | 02-07 | F   |                   | CW 50 Fizz 50              | 93-97 | R   |
|                    | /RW Raptor                            |       |     |                   | CY 50 Forte/Forte Mufa     | 96-97 | R   |
|                    | YFM 80 GT/GV/GW Grizzly               | 05-07 | F   |                   | EW 50 'Stunt'              | 00-06 | R   |
|                    | TT-R 90 M/N/P/R/ES/S/T/ET/EV/EW       | 00-07 | R   |                   | YH 50 'Flipper'            | 98-06 | R   |
|                    | AG 100 J (3HAA)                       | 82    | F   |                   | YN 50 R Ovetto             | 98-06 | R   |
|                    | AG 100 E 'Farm Bike'                  | 93    | F   |                   | CV 80 Evolis               | 97    | R   |
|                    | RT 100 E/F/K                          | 93-03 | F&R |                   | XC 125 Flame 125           | 96-03 | R   |
|                    | YB 100                                | 82-86 | R   |                   | CS 50 Z/CS 50 Mach G       | 02-06 | R   |
|                    | YB 100                                | 87-92 | F&R |                   | CW 50 RS Booster NG        | 95-06 | R   |
|                    | YZ 100 J/K                            | 82-83 | F   |                   | CW 50 RSX Booster Track    | 96-98 | R   |
|                    | RX 115 (5FS3)                         | 99    | R   |                   | CW 50 Booster              | 90-91 | F&R |
|                    | YFM 125 S/GT/GV/GW Grizzly            | 04-07 | F   |                   | CT 50 S 50RR 150           | 91-92 | F&R |
|                    | SR 125 (3MW2)                         | 89-91 | R   |                   | CR 50 Z Target             | 91-95 | R   |
|                    | SR 125 SE                             | 82    | R   |                   | YE 50 Evolis               | 92-95 | R   |
|                    | SR 125                                | 97-02 | R   |                   | CW 50 Booster              | 92-94 | F&R |
|                    | TT-R 125 M/N/P/R/ES/S/T/ET/EV/EW      | 00-07 | F&R |                   | CW 50 Booster (12" wheels) | 06    | R   |
|                    | TT-R 125 LWM/LWN/LWP/LWR/LWES         |       |     |                   | CW 50 Power Rocket         | 06    | R   |
|                    | /LWS/LWET/LWT/LV/LEV/LEW              | 00-07 | R   |                   | CT 50 SS Sorriso           | 93-95 | F&R |
|                    | TW 125                                | 99-02 | R   |                   | EW 50 Stunt Naked          | 05-06 | R   |
|                    | XC 125 TR 'Cygnus'                    | 96-03 | R   |                   | YA 50 R Forte              | 94-95 | R   |
|                    | XT 125                                | 82    | R   |                   | YM 50 Fizz                 | 94-95 | R   |
|                    | AG 200 E (3GX6)                       | 93    | F   |                   | XC 125 T Flame             | 95-96 | R   |
|                    | TW 200 (2JL/4CS1/2/3/4/5/6/5LB1/2)    | 01-02 | R   |                   | YA 50 TA Sorriso           | 95-96 | F&R |
|                    | YTM 200 EL/DX                         | 89    | F   |                   | CW 50 Booster Spirit       | 96-98 | R   |
|                    | YFS 200 B/F/G/H/J/K/L/M/N/P 'Blaster' | 91-02 | F   |                   | <b>QUADZILLA</b>           |       |     |
|                    | YFM 200 N                             | 85    | F   |                   | X 100 E (XLC)              | 06    | F   |
|                    | YFM 200 DXW/DX/DXA                    | 89-90 | F   |                   | Pro Sharke                 | 06    | F   |
|                    | ST 225 (5BT) Bronco                   | 97    | R   |                   | Pro Shark 100 R MX         | 07    | F   |
|                    | XT 225 (2LN) Serrow (1KH 20101-)      | 86-87 | R   |                   | Stinger R 170 E            | 06    | F   |
|                    | XT 225 (3RW1-5 Serrow)                |       |     |                   | ST 200 E (Automatic)       | 06    | F   |
|                    | (1KH 034101-132000)                   | 89-93 | R   |                   | <b>TGB</b>                 |       |     |
|                    | YTM 225 DRN                           | 85    | F   | 8025686000        | Trigger 50                 |       | R   |
|                    | YFM 225 S/T/U                         | 86-89 | F   | 802569600         | Akros Tec 50               |       | R   |
|                    | YFAI W/A/B//F/G/H/J/K/L               |       |     | T01-46421-00      | High Wheel 50              |       | R   |
|                    | /M/N/P/R Breeze                       | 89-03 | F   |                   | 101 R (50/125/150)         | 05-06 | R   |
|                    | YFB 250 D/E/F Timberwolf              | 92-94 | F   |                   | 309 RS 50                  |       | R   |
|                    | <b>BSM</b>                            |       |     |                   | F409 Cruise 50/125         | 05    | R   |
|                    | TB 100                                |       | R   |                   | F409 (50/125/150)          | 06    | R   |
|                    | <b>ADLY</b>                           |       |     |                   | <b>PGO</b>                 |       |     |
|                    | Jet 50/100                            |       | R   |                   | My Bubu 50                 | 03    | R   |
|                    | City Bird                             |       | R   |                   |                            |       |     |
|                    | Predator 50/100                       |       | R   |                   |                            |       |     |
|                    | Fox 50                                |       | R   |                   |                            |       |     |
|                    | Panther 50/100                        | 02-06 | R   | <b>Y504</b>       | <b>CPI</b>                 |       |     |
|                    | Cosy 50/80                            | 02-06 | R   | 122 25330 00      | Popcorn 50                 | 03-06 | R   |
|                    | Road Tracer 50/90/100                 | 04-06 | R   | 296 25330 00      | <b>YAMAHA</b>              |       |     |
|                    | SS 50 1/11 Supersonic                 | 04-05 | R   | 296 W2536 00      | DT 50 M/MX                 | 78-86 | F&R |
|                    | SS 100 1/11 Supersonic                | 04-05 | R   | 326 25330 00      | FS1E                       | 74-76 | F&R |
|                    | <b>CPI</b>                            |       |     | 326 25330 10      | FS1E 'DX'                  | 77-79 | R   |
|                    | Baby J 50                             | 02    | R   | 326 W2536 00      | FS1 'DX'                   | 79-80 | R   |
|                    | Oliver 50 (All models)                | 03-06 | R   | 393 25130 00      | FS1 'SE'                   | 81-82 | F&R |
|                    | Popcorn 50                            | 02    | R   | 10X W25236 00     | RD 50 M                    | 78-80 | R   |
|                    | 50 Hussar                             | 01-05 | R   | 2JL W2536 00      | RD 50 MX/RD 50 M           | 81-87 | R   |
|                    | <b>DERBI</b>                          |       |     | 2JL W2536 01      | TY 50/50 M                 | 77-80 | F&R |
|                    | DXR 200 Quad                          | 04    | F   | 2JN W2536 00      | V 50 M/P                   | 74-82 | F&R |
|                    | DXR 250 Quad                          | 04-05 | F   | 437 25130 00      | V 70 A                     | 76    | F&R |
|                    | <b>GARELLI</b>                        |       |     | 2JL W2534 00      | V 75 A                     | 77    | F&R |
|                    | Queenie                               | 95-   | R   | 2JL W2534 20      | DT 80 MX                   | 81-83 | F&R |
|                    | Grinta                                | 95-   | R   | 54200 BMAT 000    | LB 2/80 'Bop 2'            | 80    | F&R |
|                    | FX 50                                 |       | R   |                   | RD 80 (Air Cooled) (LC)    | 82    | R   |
|                    | <b>GENERIC</b>                        |       |     |                   | TY 80                      | 77    | R   |
|                    | XOR 50                                | 05-07 | R   |                   | V 80                       | 79-82 | F&R |
|                    | Ideo 50                               | 05-07 | R   |                   | YZ 80 D/E/F                | 77-79 | R   |
|                    | <b>JORDAN</b>                         |       |     |                   | V 90                       | 78    | F&R |
|                    | Easy 50/100                           | 03-04 | R   |                   | DT 100                     | 76-80 | F   |
|                    | <b>KEEWAY</b>                         |       |     |                   | RS 100                     | 75-80 | F&R |
|                    | Hurricane 50                          | 07    | R   |                   | RS 100 DX                  | 77-80 | R   |
|                    | Hurricane 50-Base                     | 07    | R   |                   | YB 100                     | 78-81 | F&R |
|                    | RY8                                   | 07    | R   |                   | YB 100                     | 82-86 | F   |
|                    | Focus 25/50                           | 07    | R   |                   | YZ 100 E/F/G/H             | 78-81 | F   |
|                    | <b>POLARIS</b>                        |       |     |                   | IT 125 G/H/J               | 80-82 | F   |
|                    | Cyclone '250X'                        | 87    | F   |                   | TY 125                     | 82    | F   |
|                    | Scrambler (3 wheeler)                 | 85-86 | F   |                   | TY 175                     | 77-80 | F   |
|                    | Trail Boss 2x4                        | 85-87 | F   |                   | TY 250 D/E                 | 77-78 | F   |
|                    | <b>MBK</b>                            |       |     |                   | TY 250 S/R                 | 84-92 | R   |
|                    | CV 50 Evolis                          | 97    | R   |                   |                            |       |     |
|                    | CW 50 RS 'Booster' 'Spirit'           | 99-06 | R   |                   |                            |       |     |
|                    | CW 50 RSP "Rocket"                    | 97-98 | R   |                   |                            |       |     |













| Part No.   | Make/Model   | Year   |   | Part No.  | Make/Model  | Year  |   |
|--|--|--|---|---|---|---|---|
| <b>860 Contd.</b>                                | <b>BMW Contd.</b><br>R 100 RS<br>R 100 RT  | 76-09/80<br>78-09/80   | R<br>R  | <b>885</b><br>2691825                                   | <b>PIAGGIO</b><br>Sefera Base 50<br>Sefera 50 Maquillage 2<br>SXR 80 City   | 91-93<br>94<br>99   | F<br>F<br>F   |
| <b>861</b><br>34-21-2-310-523                    | <b>BMW</b><br>K 75/7-2<br>K 75 C<br>R 45/45 N<br>R 45 T<br>R 65<br>R 65 GS<br>R 65 RT<br>R 65 T<br>R 80<br>R 80/R 80 RT<br>R 80 RT<br>R 80/R 80 RT<br>R 80 GS<br>R 80 ST<br>R 80 TIC<br>R 100/7T<br>R 100 RS<br>R 100 RT | 84-96<br>85-02/88<br>10/80-85<br>80-85<br>07/88-08/89<br>87-92<br>85-88<br>80-85<br>10/80-84<br>84-07/90<br>82-84<br>84-95<br>80-87<br>82-84<br>09/80-85<br>09/80-84<br>86-08/89<br>87-08/89 | R<br>R<br>R<br>R<br>R<br>R<br>R<br>R<br>R<br>R<br>R<br>R<br>R<br>R<br>R<br>R<br>R<br>R<br>R | <b>886</b><br>272714                                    | <b>PIAGGIO</b><br>Quartz 50   | 92-96   | R   |
| <b>862</b><br>34 21 1 242 603<br>34 21 1 242 604 | <b>BMW</b><br>R 65 LS  | 81-85  | R   | <b>889</b>  | <b>MONTESA</b><br>Old models  |   | R   |
| <b>863</b>                                       | <b>BMW</b><br>K 75/75-S  | 84-08/88   | R   | <b>890</b><br>499124                                    | <b>PIAGGIO</b><br>Scatto 50   | 92-93   | F&R   |
| <b>864</b><br>34 11 2 311 079                    | <b>BMW</b><br>R 50/5 / 60/5 / 60/6 / 75/5  | 69-76  | F   | <b>893</b><br>8213133                                   | <b>APRILIA</b><br>Amico 'All models'<br>SR Scooters 'All air cooled models'<br>Rally Scooter 'All air cooled models'<br>Gulliver 'All models'<br>Sonic (All models)<br>Scarabeo 50<br>Scarabeo 50 2T (Rear drum models)   | 96-98<br>93-02<br>95-02<br>95-98<br>98-07<br>93-99<br>98-07                                       | R<br>R<br>R<br>R<br>R<br>R<br>R                     |
| <b>869</b>                                       | <b>KREIDLER</b><br>RS Typ K 54/53<br>RSH Typ K 54/53H  | F&R<br>F&R   |   | 1242150000  | <b>BETA</b><br>Tempo<br>Quadra 50<br>Ark (Air Cooled)   | 94-02<br>97-00<br>96-07   | R<br>R<br>R   |
| <b>873</b>                                       | <b>MOTO BECANE</b><br>50 all mod. Atom hub<br>50 all mod. Leleu hub  | 88-<br>88-   | R<br>R  | 44790031A0  | <b>BENELLI</b><br>K2 Scooter 50<br>Naked 50<br>Naked 100<br>Pepe 50/50 LX<br>491 (All drum rear models)<br>Pepe 100 LX  | 98-01<br>02-03<br>02<br>99-07<br>98-04<br>99-02   | R<br>R<br>R<br>R<br>R<br>R                          |
| <b>875</b>                                       | <b>CASAL</b><br>Mofas<br>Boss  |  | F&R<br>F&R  | Y00FA0152   | <b>CAGIVA</b><br>City 50<br><b>MALAGUTI</b><br>Ciak 50/100<br>Centro SL/SL Cat<br>Centro Base 50<br>F10 Jet Line/Jet Line WAP<br>Firefox F15 (Air cooled models)<br>F15 RR<br>Phantom F12 (A/C)<br>Phantom F69 (70cc)<br>Yesterday<br>50 America<br>50 Raid         | 91-94<br>00-04<br>94-00<br>93-94<br>96-07<br>99-06<br>99-00<br>94-07<br>98<br>98-03<br>91-<br>91- | R<br>R<br>R<br>R<br>R<br>R<br>R<br>R<br>R<br>R<br>R |
| <b>877</b>                                       | <b>GARELLI</b><br>50 Team Matic<br><b>MOTO BECANE</b><br>51 SUE<br>Rock/Rock A<br>Magnum/A/racing  | 88-  | F<br>F&R<br>F&R<br>F&R  | 11940300<br>11946300                                    | <b>PIAGGIO</b><br>Typhoon 50  | 06-07   | R   |
| <b>878</b>                                       | <b>MOTOBECANE</b><br>40 AE/41 AE<br>50 A/E/AE<br>51 SA/SAE/SV/SVE<br>51 VLM  |  | F&R<br>F&R<br>F&R<br>F&R  | <b>894</b>  | <b>CASAL</b><br>Mofas drum dia. 110mm   |   | F&R   |
| <b>881</b><br>414437                             | <b>PIAGGIO</b><br>Cosa CL/CLX 125<br>Cosa 2 125<br>Cosa CL/CLX 150<br>Cosa 2 50<br>Cosa CL/CLX 200<br>Cosa 2 200   | 88-91<br>91-97<br>88-91<br>91-97<br>88-91<br>91-97   | R<br>R<br>R<br>R<br>R<br>R  | <b>895</b>  | <b>CASAL</b><br>50 Ciclomotori  |   | F&R   |
| <b>882</b><br>414429                             | <b>PIAGGIO</b><br>Cosa CL/CLX 125<br>Cosa 2 50/125<br>Cosa CL/CLX 150<br>Cosa CL/CLX 200<br>Cosa 2 200   | 88-91<br>91-97<br>88-91<br>88-91<br>91-97  | F<br>F<br>F<br>F<br>F   | <b>896</b><br>498117                                    | <b>CASAL - Mofas drum dia. 140mm</b><br><b>PIAGGIO</b><br>Superbrand 50<br>Zip 7 Zip 50 Bimodale  | 85-90<br>94-97  | F<br>F  |
| <b>883</b>                                       | <b>GILERA</b><br>Bullit 50   | 90-  | R   | <b>897</b><br>64400 41820<br>64400 41840<br>64400 41850 | <b>ADLY</b><br>RT 50/100<br><b>HYOSUNG</b><br>Grand Prix 125<br><b>PGO</b><br>G-Max 50<br>Rodo Show<br>PMX 50/110<br>Mega 50<br>Big Max 50/90<br>EPS<br>Tornado 50/125<br>Galaxy 25/50/90<br><b>SUZUKI</b><br>TR 50 SW/SX<br>UG 110 W/SW/Y/SY/SK1<br>Address/Yokuto | 99-04<br>05-07<br>00-06<br>00-07<br>94-<br>94-06<br>97<br>97<br>94-                               | R<br>R<br>R<br>R<br>R<br>R<br>R<br>R                |



| Part No.                  | Make/Model  | Year   |  | Part No.   | Make/Model   | Year  |   |
|---------------------------|---|--|--|--|--|---|---|
| <b>909</b><br>414497      | <b>FANTIC</b><br>50 Sprinter/3V.R<br><b>GARELLI</b><br>Junior Turismo<br><b>GILERA</b><br>50 GSA/Vale<br>50 Trend<br>50 Trial/Enduro<br><b>PIAGGIO (VESPA)</b><br>Ciao All Models<br>Ciao 50 Catalitico<br>Bravo 50 Alloy Wheels<br>Free 50<br>Zip 50 Base (Drum Model)<br>Grillo 50<br>S1 50 Alloy Wheels<br>S1 50 FL2<br>Bravo 3<br>Boss 50   | 83-<br><br>89-<br><br>71-99<br>99-05<br>73-81<br>92-00<br>89-93<br>79-88<br>91-97<br>87-90<br>88-89                  | F&R<br><br>F&R<br><br>F<br>F&R<br>F&R<br><br>F<br>F<br>F<br>F<br>F<br>F<br>F<br>F            | <b>926</b><br><b>926G</b><br>8213179<br>11907700 | <b>ACCOSSATO</b><br>50 Cross Mini<br><b>ASPES</b><br>50 Navaho<br><b>FANTIC</b><br>50 Trial<br><b>GARELLI</b><br>50 Ciclone/KL 50 SV<br>Gran Turismo<br><b>MALAGUTI</b><br>Centro Base 50<br>50 Fifty HF<br>50 Watercooled<br>50 Fifty Full/CX<br>50 Fifty Top<br><b>SWM (SWM)</b><br>50/80 TR/TL Trial            | 82-<br><br>-83<br><br>93-94<br>-82<br>-82<br>83-<br>85-<br><br>-83                | F&R<br><br>F&R<br><br>F<br><br>F&R<br>F&R<br><br>F<br>R<br>R<br>R<br>R<br><br>F&R |
| <b>921</b><br>8135159     | <b>APRILIA</b><br>Classic 125<br>Red Rose 125 (Spoke wheel)<br><b>DUCATI</b><br>250/350/450 Desmo<br><b>GILERA</b><br>RV 125<br>125 Cougar<br>Strada/Sport 125<br>125 TG 1/2/3<br>TSR 125<br>TSR 125<br>200 T4/T4 C/T4 S<br><b>HERCULES (SACHS)</b><br>50 Ultra, RS Ultra<br>80 Ultra, F Ultra, RS Ultra<br>80 Ultra Chopper<br><b>LAVERDA</b><br>LB 125 Custom/Sarbia<br>LZ 125 Sport<br>LZ 125 Sport<br><b>MOTO MORINI</b><br>250 all models<br>350 Sport<br>350 FT/Turismo | 95-01<br>87<br><br>74-77<br><br>88<br>99-02<br><br>-83<br>83-<br><br>85-87<br>80-82<br>80-82<br><br>71-<br>80<br>80- | R<br>R<br><br>R<br><br>R<br>R<br>R<br>R<br>R<br>R<br>R<br>R<br>R<br>R<br>R<br>R              | <b>927G</b>                                      | <b>MOTO MORINI</b><br>350 Kanguro<br>350 Kanguro   | -83<br>84-86  | F&R<br>R  |
| 967211                    | <b>DUCATI</b><br>250/350/450 Desmo<br><b>GILERA</b><br>RV 125<br>125 Cougar<br>Strada/Sport 125<br>125 TG 1/2/3<br>TSR 125<br>TSR 125<br>200 T4/T4 C/T4 S<br><b>HERCULES (SACHS)</b><br>50 Ultra, RS Ultra<br>80 Ultra, F Ultra, RS Ultra<br>80 Ultra Chopper<br><b>LAVERDA</b><br>LB 125 Custom/Sarbia<br>LZ 125 Sport<br>LZ 125 Sport<br><b>MOTO MORINI</b><br>250 all models<br>350 Sport<br>350 FT/Turismo  | 74-77<br><br>88<br>99-02<br><br>-83<br>83-<br><br>85-87<br>80-82<br>80-82<br><br>71-<br>80<br>80-                    | R<br><br>R<br>R<br>R<br>R<br>R<br>R<br>R<br>R<br>R<br>R<br>R<br>R<br>R                       | <b>928</b>                                       | <b>DUCATI</b><br>250/350/450 Desmo   | -76   | F   |
|                           | <b>APRILIA</b><br>Classic 125<br>Red Rose 125 (Spoke wheel)<br><b>DUCATI</b><br>250/350/450 Desmo<br><b>GILERA</b><br>RV 125<br>125 Cougar<br>Strada/Sport 125<br>125 TG 1/2/3<br>TSR 125<br>TSR 125<br>200 T4/T4 C/T4 S<br><b>HERCULES (SACHS)</b><br>50 Ultra, RS Ultra<br>80 Ultra, F Ultra, RS Ultra<br>80 Ultra Chopper<br><b>LAVERDA</b><br>LB 125 Custom/Sarbia<br>LZ 125 Sport<br>LZ 125 Sport<br><b>MOTO MORINI</b><br>250 all models<br>350 Sport<br>350 FT/Turismo | 95-01<br>87<br><br>74-77<br><br>88<br>99-02<br><br>-83<br>83-<br><br>85-87<br>80-82<br>80-82<br><br>71-<br>80<br>80- | R<br>R<br><br>R<br><br>R<br>R<br>R<br>R<br>R<br>R<br>R<br>R<br>R<br>R                        | <b>929</b>                                       | <b>BENELLI</b><br>124/125 2C/125 2T/2CSE<br>125 2C twin brake<br>125 T<br>250 C/TS, 250/4<br>254/304<br>500-4<br><b>DUCATI</b><br>250/350/450 Desmo  | 76-<br>-76<br>83<br>76-<br>83<br>76-<br><br>-76                                   | R<br>R<br>R<br>R<br>R<br>R<br>R   |
|                           | <b>APRILIA</b><br>Classic 125<br>Red Rose 125 (Spoke wheel)<br><b>DUCATI</b><br>250/350/450 Desmo<br><b>GILERA</b><br>RV 125<br>125 Cougar<br>Strada/Sport 125<br>125 TG 1/2/3<br>TSR 125<br>TSR 125<br>200 T4/T4 C/T4 S<br><b>HERCULES (SACHS)</b><br>50 Ultra, RS Ultra<br>80 Ultra, F Ultra, RS Ultra<br>80 Ultra Chopper<br><b>LAVERDA</b><br>LB 125 Custom/Sarbia<br>LZ 125 Sport<br>LZ 125 Sport<br><b>MOTO MORINI</b><br>250 all models<br>350 Sport<br>350 FT/Turismo | 95-01<br>87<br><br>74-77<br><br>88<br>99-02<br><br>-83<br>83-<br><br>85-87<br>80-82<br>80-82<br><br>71-<br>80<br>80- | R<br>R<br><br>R<br><br>R<br>R<br>R<br>R<br>R<br>R<br>R<br>R<br>R                             | <b>930G</b>                                      | <b>FANTIC</b><br>50/50.1 Raider<br>50.1 Oasis KS/Rally<br>50.1 Trial<br>Trial 50 Junior<br>80 Trial<br><b>GARELLI</b><br>Trial 323<br><b>MALAGUTI</b><br>50 Enduro RCW-X/Sahib   | 81-<br>86-<br>86-<br>87-<br>83-<br><br>86-<br><br>83-                             | R<br>R<br>R<br>F&R<br>F&R<br><br>R  |
| <b>922</b><br><b>922G</b> | <b>FANTIC</b><br>50 Trial<br>50 Enduro<br>50 Caballero<br>80 Trial<br><b>GILERA</b><br>50 GR 2<br>98 Giubileo<br>124 Giubileo<br>125 Arcore<br><b>HERCULES (SACHS)</b><br>50 Supra Enduro<br>80 Ultra AC<br>80 Ultra AC Chopper<br><b>MALAGUTI</b><br>50 MDX Gold Enduro<br>50 Enduro MEX<br>50 Enduro MEX<br>50 Enduro MGX<br>50 Enduro MLX<br>50 Enduro MXS<br>50 RGT Sport<br>50 Fifty HF/NL 4 gears   | -83<br>83-<br>-83<br>-83<br><br>87-<br>85-86<br>87-<br>87-<br>87-<br>87-<br>85-<br>85-<br>87-                        | R<br>F&R<br>F&R<br>F&R<br><br>F<br>R<br>R<br>R<br>R<br>F&R<br>R<br>R<br>F&R<br>R<br>R<br>F&R | <b>931</b><br><b>931G</b>                        | <b>TOMOS</b><br>Moped with cast wheels<br><b>BENELLI</b><br>50 G2 Elle<br><b>GARELLI</b><br>50 Vip/Noi/Basic Alu wheel<br>Formuno 50<br>50 Team Matic<br><b>MALAGUTI</b><br>50 RGT Strada<br>50 Custom Fox<br>50 Dribbling<br>50 Fifty RV<br>50 Grizzly RCX 4/RCX 12<br>50 Grizzly RCX 10<br>50 Ranocchio 3 wheels | 79-<br><br>87-<br>88-<br><br>83-<br>87-<br>87-<br>87-<br>87-<br>87-<br>87-<br>87- | F&R<br><br>F&R<br>F&R<br>R<br>R<br>R<br>F&R<br>F&R<br>F&R<br>F&R<br>R<br>F&R      |
| <b>923</b>                | <b>GILERA</b><br>50 GR 2  |  | F  | <b>932</b>                                       | <b>KREIDLER</b><br>50 Flory MF 12/13<br>50 Flory MF 23/24/25<br>50 LH/LF/LFF<br>50 RMC/RMC-BG<br>Mustang 125<br>125<br>125 RS  |   | F&R<br>F&R<br>F&R<br>F&R<br>R<br>R<br>R   |
| <b>924</b>                | <b>GILERA</b><br>50 GSA/Vale  |  | R  | <b>933</b><br><b>933G</b><br>MC2855 0650         | <b>MONTESA/HONDA</b><br>Cota 123/290/349<br>Cota 123/200/242/349<br>348 Trial Enduro<br><b>PUCH</b><br>Monza 50  | -83<br>84   | F&R<br>R<br>F&R   |
| <b>925</b>                | <b>GILERA</b><br>150 Arcore   |  | F  |  |  | 83-   | F&R   |



| Part No.            | Make/Model   | Year                            |                       | Part No.        | Make/Model  | Year  |                                   |
|---------------------|--|---------------------------------|-----------------------|-----------------|---|---|-----------------------------------|
| 934G                | <b>OSSA</b><br>Pre 1980 Models<br>125 Cross<br>250 Cross/Fuego/Super Pioneer                               | 74-<br>74-                      | F&R<br>F<br>F         |                 | RX 125 Arizona  | 88  | R                                 |
| 935G                | <b>OSSA</b><br>81 Onwards  |                                 | F                     | 957             | <b>LAMBRETTA</b><br>125/150 D-LD  |   | R                                 |
| 936G                | <b>OSSA</b><br>81 Onwards<br><b>FB MINARELLI (SPAIN)</b><br>MR 80<br><b>PUCH</b><br>Monza 50 50 Alu Wheels | 84-                             | R<br>R<br>F&R         | 958             | <b>LAMBRETTA</b><br>All disc models<br>125/150/175 L1   |   | R<br>F&R                          |
| 937G                | <b>MONTESA/HONDA</b><br>Cota 123/200/242/349   | 84                              | F                     | 959             | <b>LAMBRETTA</b><br>125/150/200 DL  |   | F&R                               |
| 938<br>64400 HK3100 | <b>HYOSUNG</b><br>TE 50<br>TE 90<br>TE 100   | 05-07<br>05-07<br>05-07         | F<br>F<br>F           | 965<br>965G     | <b>ITALJET</b><br>(All Models 125cc)<br><b>BENELLI</b><br>S 50 Scooter  | 81-   | R<br>F&R                          |
| 939G                | <b>FANTIC</b><br>300 Trial<br><b>BETA</b><br>240 TR 32   | 84-85                           | F<br>F                | 966             | <b>KREIDLER</b><br>50 RM<br>80 E/L Florett  |   | F&R<br>R                          |
| 940G                | <b>ACCOSSATO</b><br>CE 80/120 Cross/Enduro H 20  | 84-                             | F                     | 967             | <b>KREIDLER</b><br>125  |   | F                                 |
| 941                 | <b>ASPES</b><br>RCL 80   |                                 | F&R                   | 970             | <b>PUCH</b><br>MS 50/50 L   |   | F&R                               |
| V942<br>266509      | <b>PIAGGIO (VESPA)</b><br>Vespa PK 50 S Automatica<br>Vespa FL2 Automatica<br>Vespa PK 125 S Automatica    | 84-89<br>90-91<br>84-89         | R<br>R<br>R           | 972             | <b>PUCH</b><br>50 KA/K2/K25/K3T/MSP   |   | F&R                               |
| 944<br>944G         | <b>CAGIVA</b><br>WMX 125 (Rimoldi Hub)<br><b>HRD</b><br>RP 50 Cross<br>RP 80 Cross                         | -85<br>83-                      | F&R<br>F&R            | 977G            | <b>CAGIVA</b><br>WMX 125<br>WM 125<br>WMX 250   | 86<br>87-88<br>86-88                            | R<br>R<br>R                       |
| 945                 | <b>BENELLI</b><br>S 50 Scooter<br><b>FANTIC</b><br>50 Iesimo spoke wheel<br>50 Joy                         | 81-<br>92-                      | F<br>F&R<br>F&R       | 978             | <b>MZ</b><br>Saxon 125<br>Saxon 150<br>ETZ 250/300<br>TS 125/150<br>TS 250<br>251 Fun<br>Saxon 'Tour' 251/301<br>Saxon 500 'All models' | 93-97<br>95<br>85-92<br>95-96<br>93-98<br>93-98 | R<br>R<br>F<br>F&R<br>R<br>R<br>R |
| 946                 | <b>BENELLI</b><br>125 2C twin brake  | -76                             | F                     | 979             | <b>MZ</b><br>TS 125/150<br>ETZ 125/150  | 85-92   | R<br>R                            |
| 949                 | <b>CAGIVA</b><br>Roadster 125<br><b>CZ / JAWA</b><br>125/175/250/350<br>125/175/250/350                    | 96-99<br>-74<br>75-             | R<br>F&R<br>R         | 980             | <b>MZ</b><br>Simpson  | 80-94   | F&R                               |
| 950                 | <b>CZ / JAWA</b><br>Scrambler Cross 125 x 300<br>Jawa 250/400 Cross<br>250/380 (Models 513/514)            | 65-76<br>65-76<br>77-79         | F&R<br>F&R<br>R       | 982G            | <b>CAGIVA</b><br>WMX 500  | 84-86   | R                                 |
| 951                 | <b>CZ / JAWA</b><br>125/175/250/350  | 75-                             | F                     | 983             | <b>GARELLI</b><br>GTA 125   | 85  | R                                 |
| 952                 | <b>GARELLI</b><br>125 XR/XRD Tiger<br><b>GILERA</b><br>125 HX LC   | 83-<br>83-                      | R<br>R                | 984<br>XH295500 | <b>HUSQVARNA</b><br>Husky Boy<br>Husky Boy J<br>Husky Boy R<br>Husky Boy Racing S<br>Husky Boy Racing J<br>Husky Boy S                  | 00-02<br>01-02<br>01<br>00<br>00<br>01-02       | F&R<br>R<br>R<br>F&R<br>F&R<br>R  |
| 954                 | <b>GILERA</b><br>125 RX<br>RX 200/Arizona/Enduro<br>200 Arizona Hawk<br>200 RTX<br>200 ER                  | 84-<br>85-<br>85-<br>85-<br>87- | R<br>R<br>R<br>R<br>R | 985             | <b>FB MINARELLI (SPAIN)</b><br>Rieju Marathon   | 74-   | F&R                               |
|                     |  |                                 |                       | 987             | <b>GILERA</b><br>350 Dakota<br>ER 350<br>500 Dakota<br>ER 500   | 85-<br>87-<br>87-<br>87-                        | R<br>R<br>R<br>R                  |
|                     |  |                                 |                       | 990G            | <b>OSSA</b><br>125 Cross<br>250 Cross/Fuego/Super Pioneer   | 74-<br>74-                                      | R<br>R                            |

| Part No.       | Make/Model                       | Year  |   | Part No. | Make/Model | Year |  |
|----------------|----------------------------------|-------|---|----------|------------|------|--|
| 991            | use S624                         |       |   |          |            |      |  |
| 995<br>8213179 | <b>APRILIA</b><br>Classic 50     | 92-01 | R |          |            |      |  |
|                | <b>FANTIC</b><br>50.1 Oasis Kick | 87-   | R |          |            |      |  |
|                | 50.1 Trial H 20                  | 87-   | R |          |            |      |  |



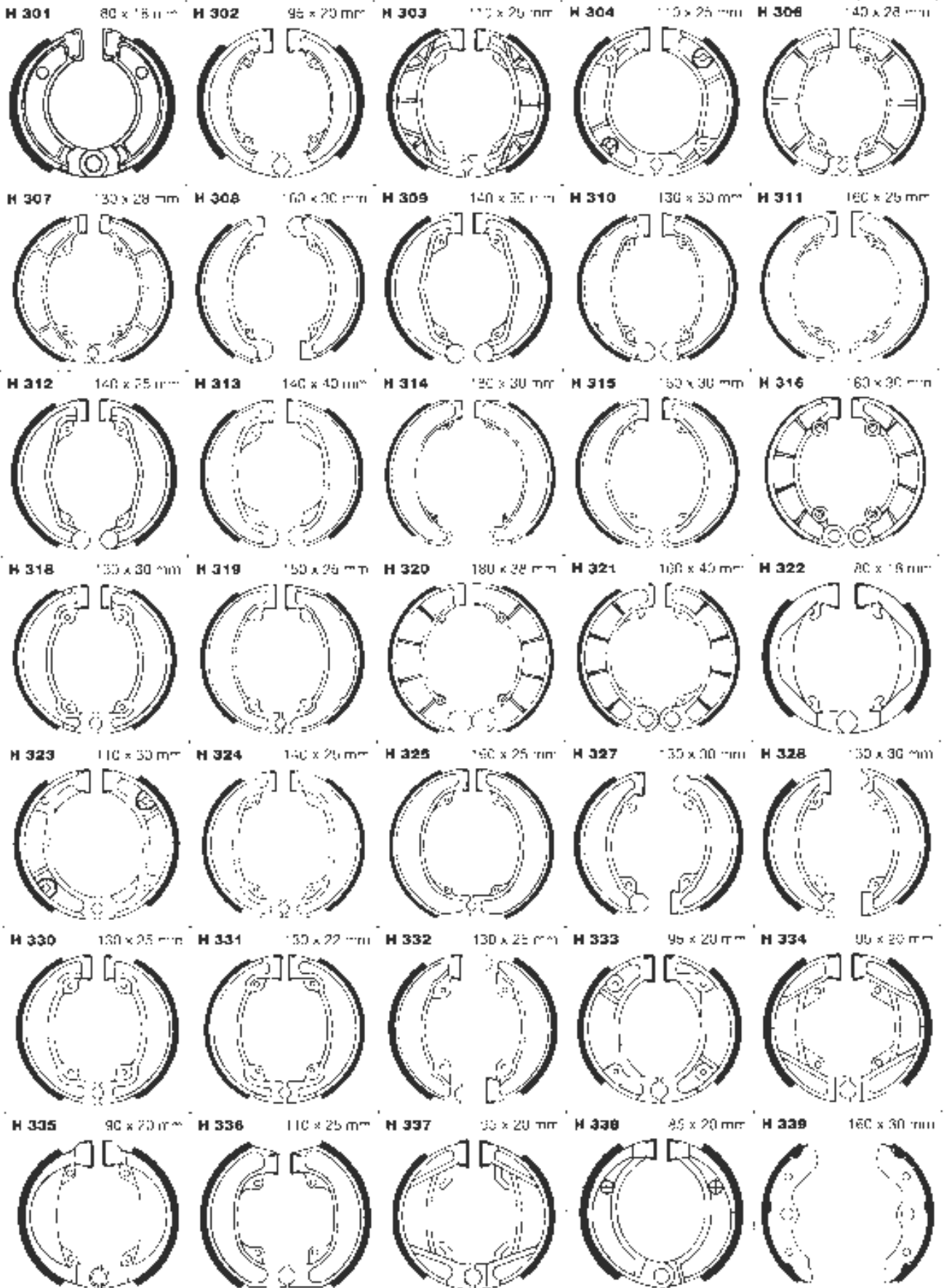



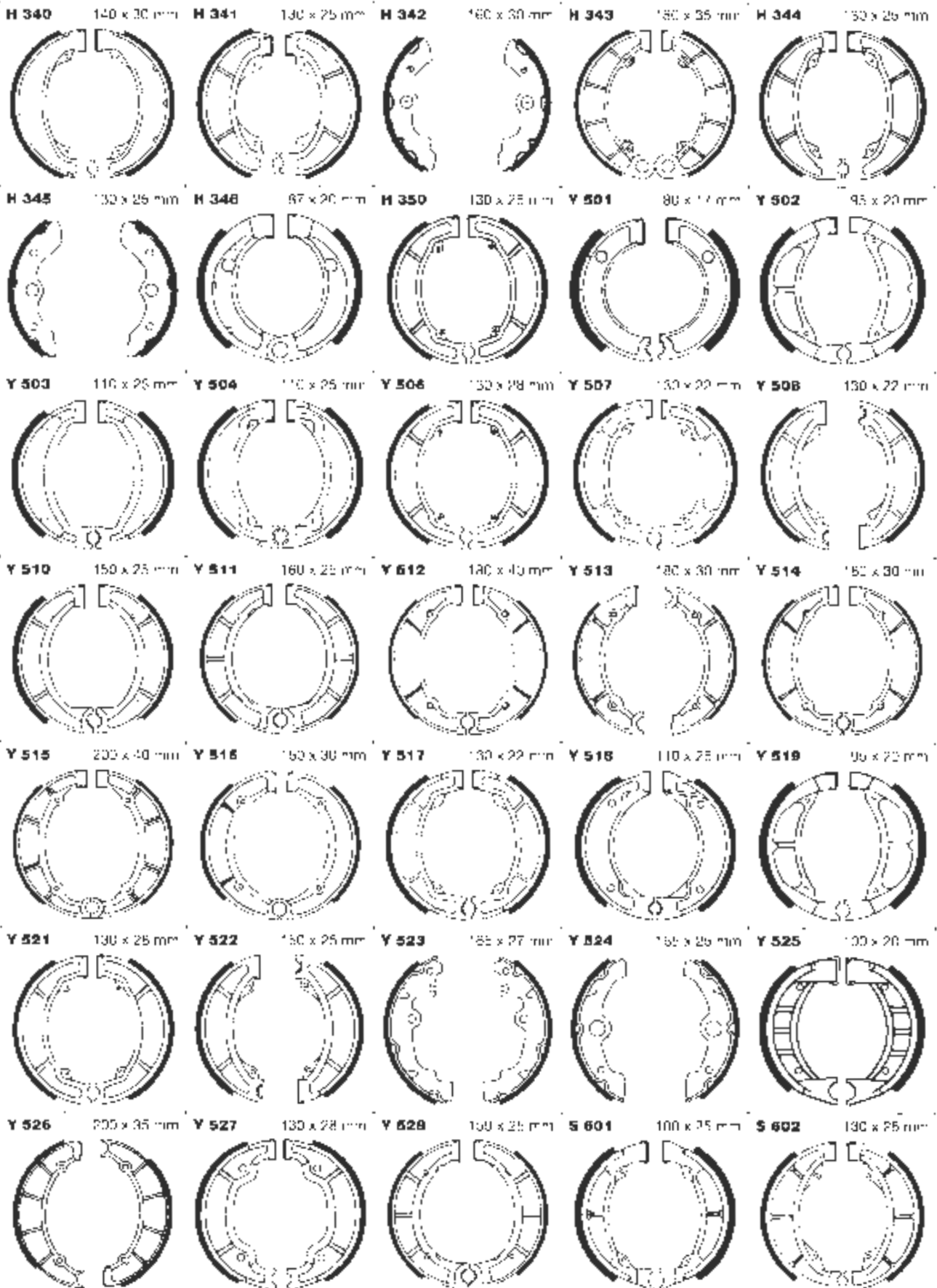



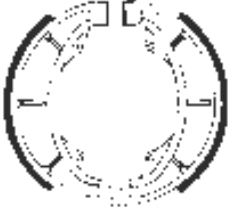

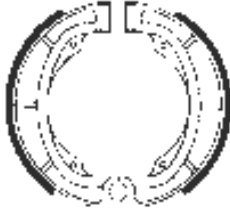

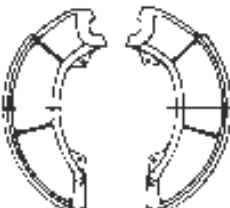
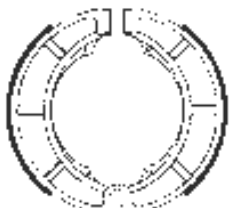



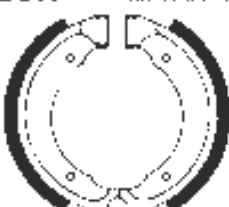



# BRAKE SHOE ILLUSTRATIONS

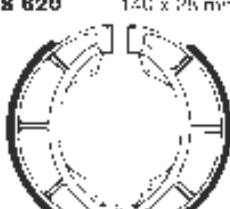
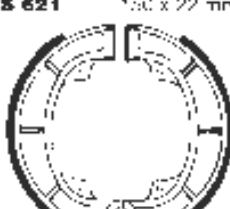
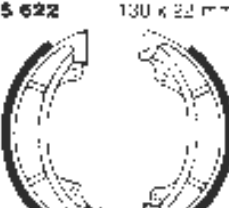
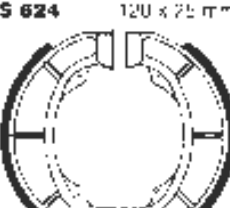

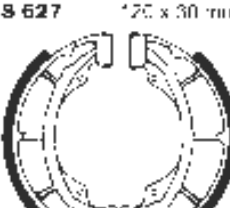
# BRAKE SHOE ILLUSTRATIONS

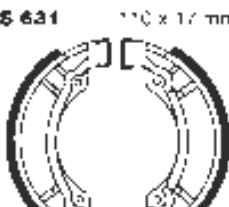
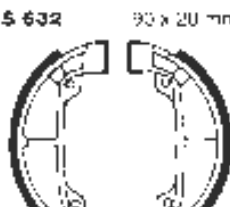

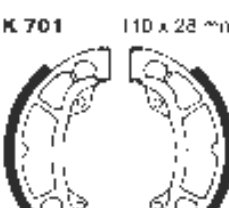
# BRAKE SHOE ILLUSTRATIONS

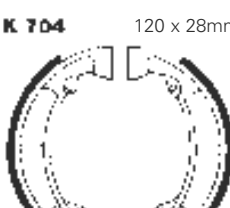
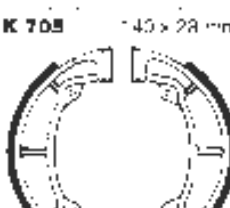
|  |  |  |   |  |
|--|--|--|---|--|
| <b>S 602 A</b><br>130 x 25 mm<br> | <b>S 603</b><br>110 x 30 mm<br>   | <b>S 604</b><br>110 x 25 mm<br>   | <b>S 605</b><br>150 x 28 mm<br>   | <b>S 606</b><br>160 x 30 mm<br>   |
| <b>S 607</b><br>108 x 28 mm<br>   | <b>S 608</b><br>175 x 28 mm<br>   | <b>S 609</b><br>160 x 28 mm<br>   | <b>S 610</b><br>180 x 40 mm<br>   | <b>S 611</b><br>180 x 22 mm<br>   |
| <b>S 612</b><br>200 x 40 mm<br>   | <b>S 613</b><br>90 x 20 mm<br>    | <b>S 614</b><br>80 x 20 mm<br>    | <b>S 615</b><br>100 x 20 mm<br>   | <b>S 616</b><br>120 x 22 mm<br>   |
| <b>S 617</b><br>120 x 28 mm<br> | <b>S 618</b><br>130 x 22 mm<br> | <b>S 619</b><br>130 x 23 mm<br> | <b>S 620</b><br>140 x 25 mm<br> | <b>S 621</b><br>150 x 22 mm<br> |
| <b>S 622</b><br>130 x 22 mm<br> | <b>S 624</b><br>120 x 25 mm<br> | <b>S 625</b><br>140 x 20 mm<br> | <b>S 626</b><br>180 x 36 mm<br> | <b>S 627</b><br>120 x 30 mm<br> |
| <b>S 628</b><br>170 x 32 mm<br> | <b>S 630</b><br>160 x 30 mm<br> | <b>S 631</b><br>170 x 17 mm<br> | <b>S 632</b><br>90 x 20 mm<br>  | <b>S 633</b><br>150 x 30 mm<br> |
| <b>K 701</b><br>110 x 28 mm<br> | <b>K 702</b><br>110 x 30 mm<br> | <b>K 703</b><br>120 x 35 mm<br> | <b>K 704</b><br>120 x 28 mm<br> | <b>K 705</b><br>140 x 28 mm<br> |

DISCONTINUED

USE S634

USE S606

# BRAKE SHOE ILLUSTRATIONS

SHOE  
BUYERS GUIDE

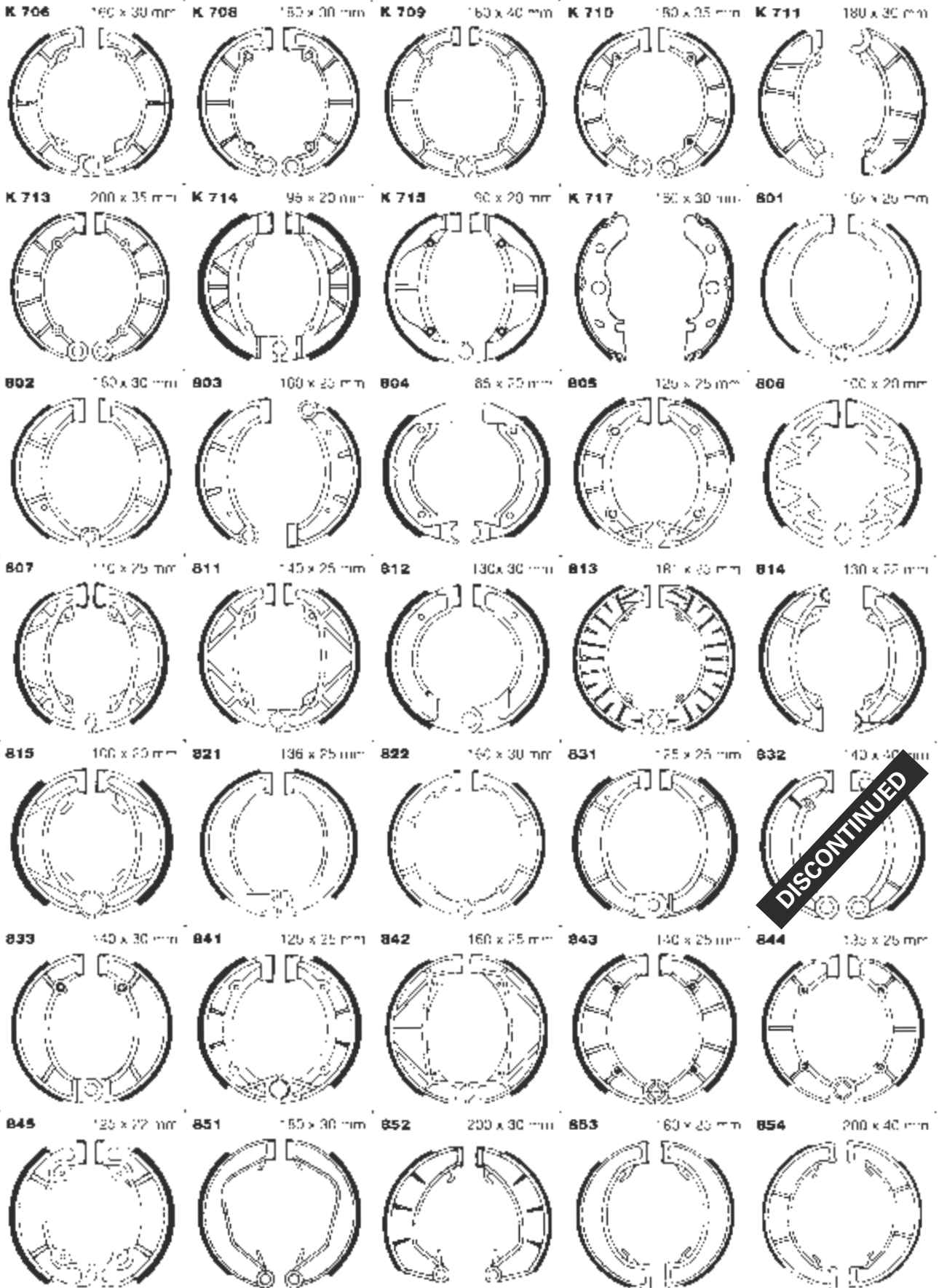

# BRAKE SHOE ILLUSTRATIONS

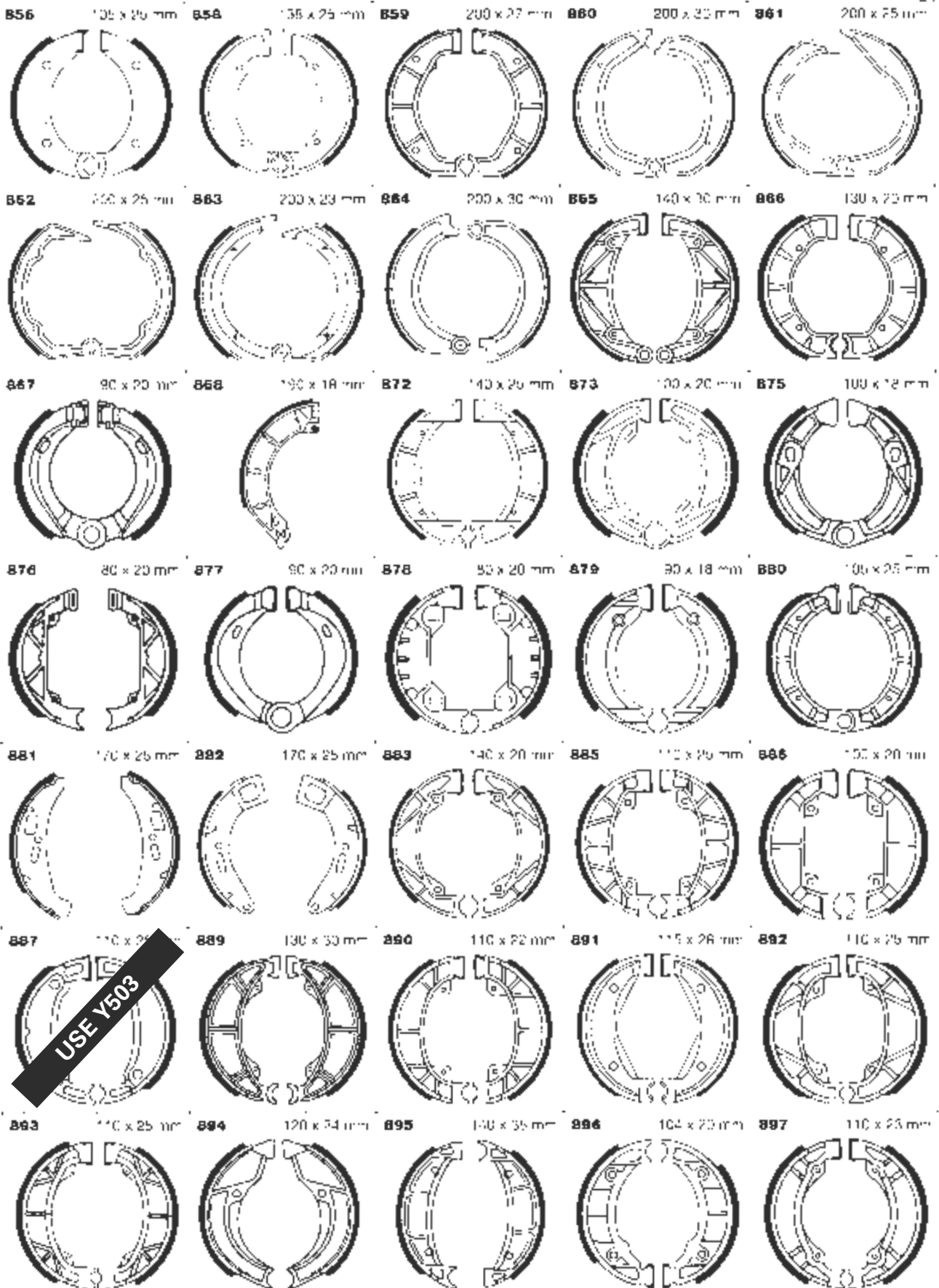

USE Y503

# BRAKE SHOE ILLUSTRATIONS

SHOE  
BUYERS GUIDE

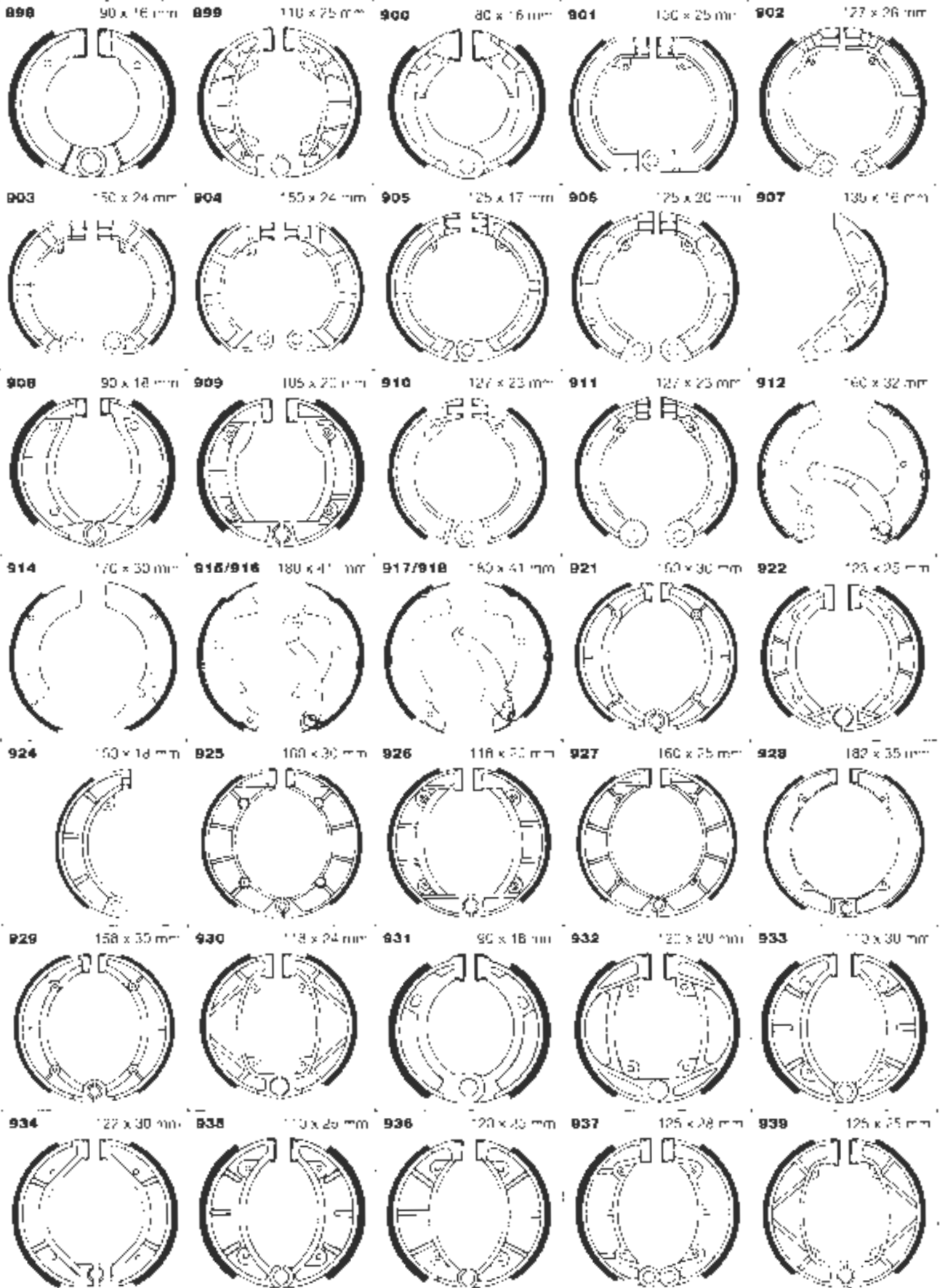



# BRAKE SHOE ILLUSTRATIONS

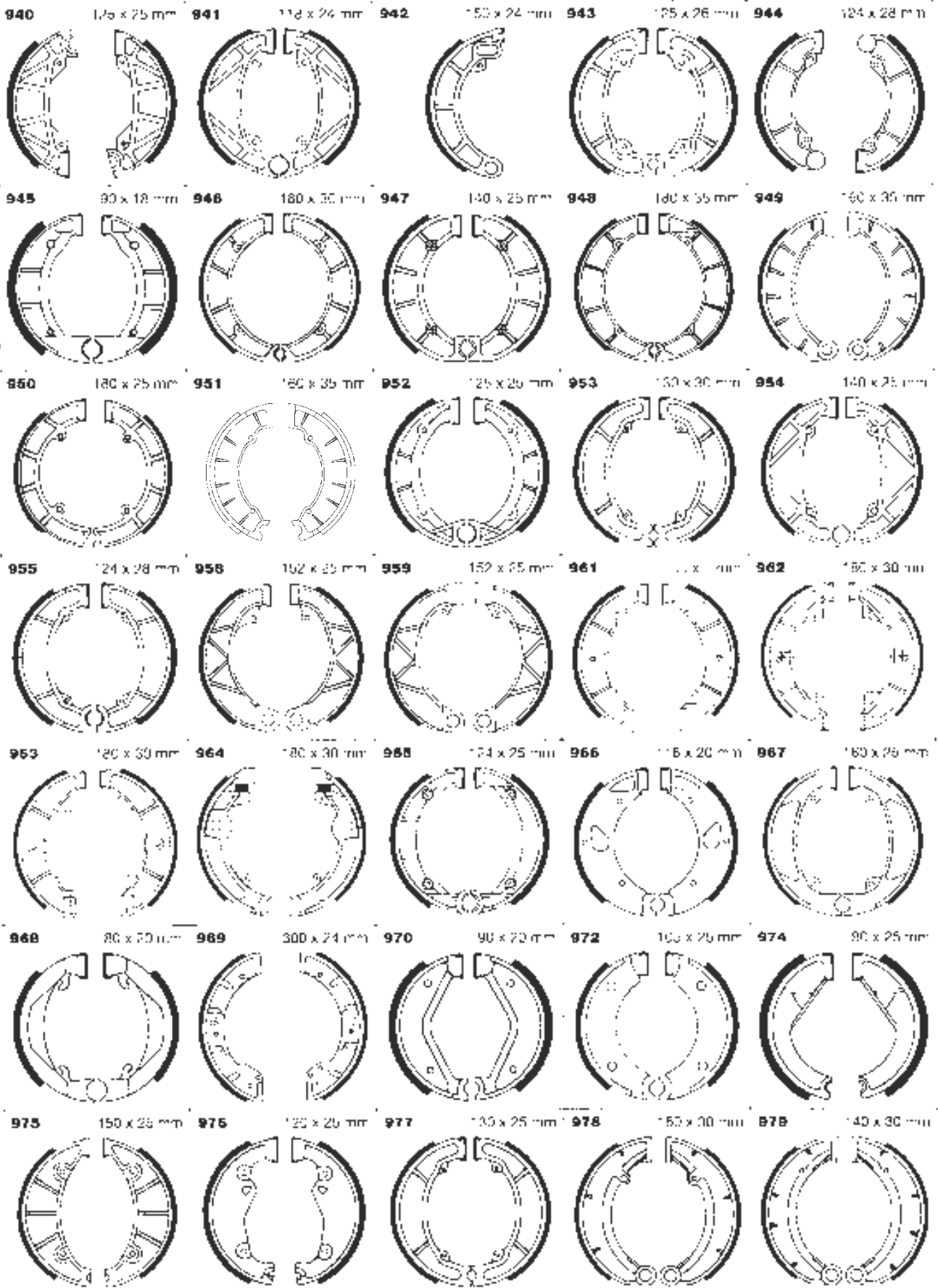

# BRAKE SHOE ILLUSTRATIONS

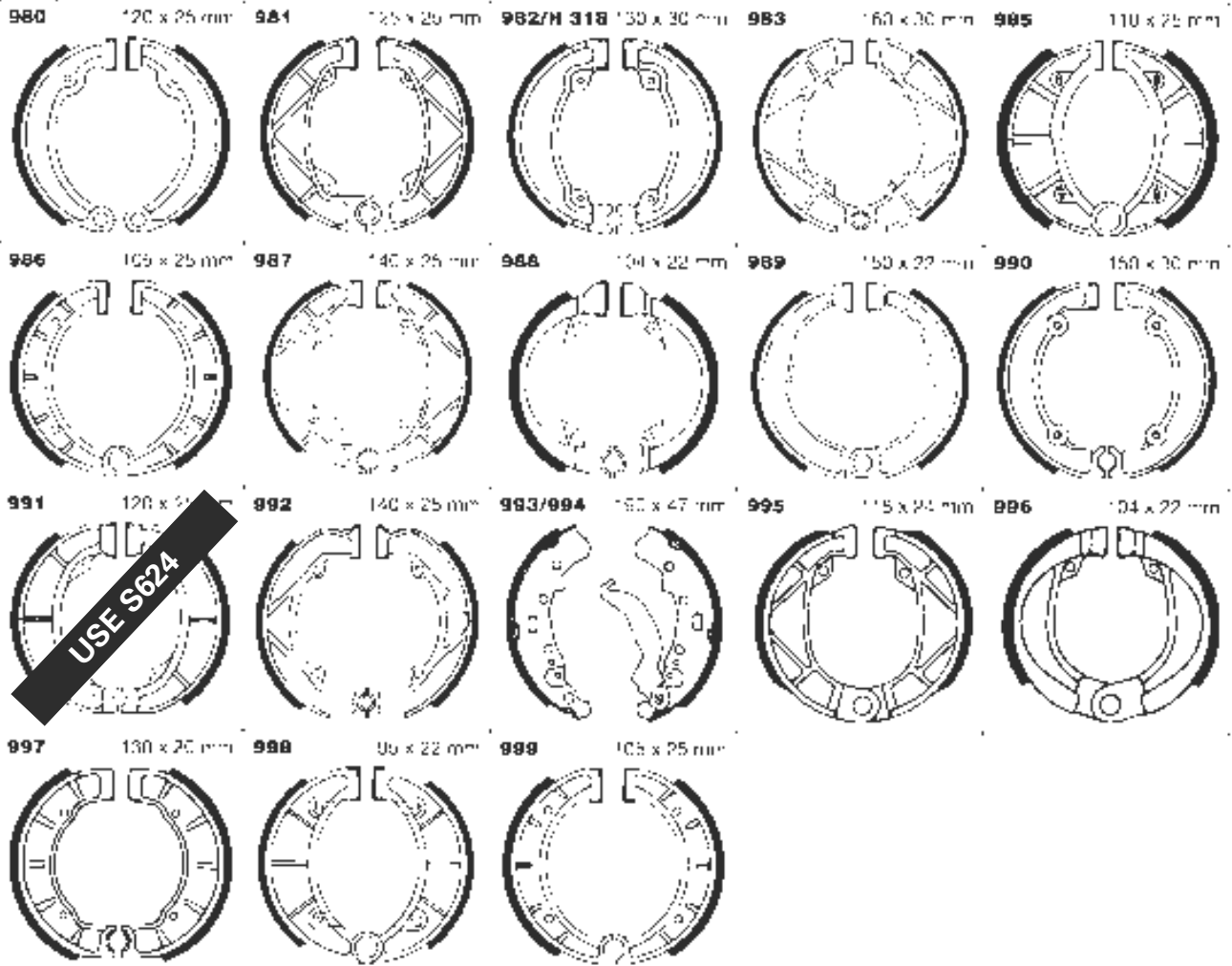

USE S624

# BRAKE SHOE ILLUSTRATIONS

|       |            |        |            |       |            |       |            |       |            |
|-------|------------|--------|------------|-------|------------|-------|------------|-------|------------|
| H 347 | 160 x 20mm | H 347S | 160 x 20mm | H 351 | 160 x 30mm | Y 520 | 165 x 30mm | S 629 | 165 x 28mm |
|       |            |        |            |       |            |       |            |       |            |
| S 634 | 180 x 40mm | K 718  | 165 x 26mm | K 719 | 180 x 26mm | K 720 | 180 x 25mm | 810   | 140 x 25mm |
|       |            |        |            |       |            |       |            |       |            |
| 816   | 140 x 25mm | 817    | 120 x 25mm | 818   | 130 x 25mm | 819   | 150 x 30mm | 820   | 130 x 28mm |
|       |            |        |            |       |            |       |            |       |            |
|       |            |        |            |       |            |       |            |       |            |
| 857   | 130 x 25mm | 957    | 142 x 20mm | H352  | 130 x 25mm | H353  | 110 x 25mm | Y530  | 110 x 25mm |
|       |            |        |            |       |            |       |            |       |            |
| Y531  | 130 x 28mm | Y532   | 160 x 30mm | Y533  | 150 x 28mm | Y534  | 160 x 32mm | S635  | 130 x 28mm |
|       |            |        |            |       |            |       |            |       |            |
|       |            |        |            |       |            |       |            |       |            |
| S636  | 140 x 30mm | 938    | 110 x 22mm | 984   | 90 x 20mm  |       |            |       |            |
|       |            |        |            |       |            |       |            |       |            |
|       |            |        |            |       |            |       |            |       |            |

# BRAKE SHOE COMPETITOR INTERCHANGE

SHOE BUYERS GUIDE

| VESRAH | EBC    | VESRAH    | EBC        | DP         | EBC        | SBS     | EBC  | SBS     | EBC   |
|--------|--------|-----------|------------|------------|------------|---------|------|---------|-------|
| VB101  | H303   | VB315     | S621       | 9138       | S614       | SBS2012 | H303 | SBS2102 | S616  |
| VB110  | H303   | VB316     | S616       | 9139       | H318       | SBS2013 | H304 | SBS2103 | S617  |
| VB117  | H317   | VB318     | S620       | 9140       | Y518       | SBS2014 | S602 | SBS2104 | S618  |
| VB119  | H314   | VB319     | S/Y502     | 9141       | Y519       | SBS2015 | S603 | SBS2107 | S621  |
| VB123  | H307   | VB320     | S625       | 9142       | K702       | SBS2016 | K706 | SBS2108 | S622  |
| VB124  | H311   | VB321     | S626       | 9143       | K703       | SBS2017 | S604 | SBS2110 | S629  |
| VB125  | H312   | VB322     | S601       | 9144       | K602A      | SBS2018 | S606 | SBS2111 | S606  |
| VB126  | H304   | VB323     | S614       | 9145       | K710       | SBS2019 | H306 | SBS2112 | Y501  |
| VB127  | H315   | VB324     | S631       | 9146       | H339       | SBS2020 | S613 | SBS2113 | Y513  |
| VB128  | H316   | VB325     | S632       | 9147       | H342       | SBS2021 | Y519 | SBS2114 | Y520  |
| VB129  | H320   | VB326     | S633       | 9148       | H343       | SBS2022 | S615 | SBS2115 | Y521  |
| VB130  | H310   | VB327     | S628       | 9149       | H345       | SBS2023 | H312 | SBS2116 | 801   |
| VB132  | H313   | VB328     | S624       | 9150       | H347       | SBS2024 | H315 | SBS2117 | 802   |
| VB133  | H321   | VB329     | S629       | 9151       | Y527       | SBS2025 | K703 | SBS2118 | 803   |
| VB134  | H301   | VB330     | 897        | 9152       | Y528       | SBS2026 | H318 | SBS2120 | 812   |
| VB135  | H306   | VB404     | K708       | 9153       | S610       | SBS2027 | H320 | SBS2121 | 813   |
| VB136  | H318   | VB405     | K713       | 9154       | -          | SBS2028 | Y503 | SBS2122 | 814   |
| VB137  | H324   | VB406     | K/S603     | 9155       | S624       | SBS2029 | H323 | SBS2139 | 860   |
| VB138  | H325   | VB407     | K/S605     | 9156       | S625       | SBS2030 | H332 | SBS2140 | 861   |
| VB139  | H309   | VB408     | K704       | 9157       | S626       | SBS2031 | H324 | SBS2141 | 862   |
| VB140  | H323   | VB409     | K602A      | 9158       | S628       | SBS2032 | Y504 | SBS2143 | 859   |
| VB141  | H302   | VB410     | K/S602     | 9159       | S629       | SBS2033 | Y507 | SBS2146 | V903  |
| VB142  | H330   | VB411     | K705       | 9160       | S633       | SBS2034 | Y506 | SB2171  | 978   |
| VB143  | H331   | VB412     | K709       | 9161       | K705       | SBS2035 | Y511 | SBS2172 | 979   |
| VB144  | H328   | VB413     | K706       | 9162       | K717       | SBS2036 | Y508 | SBS2177 | Y523  |
| VB146  | H343   | VB414     | K701       | 9163       | Y520       | SBS2037 | Y510 | SBS2178 | Y524  |
| VB147  | H339   | VB415     | K714       | 9165       | Y524       | SBS2038 | K706 | SBS2181 | S624  |
| VB148  | H332   | VB416     | K703       | 9166       | Y523       | SBS2039 | K704 | SBS2182 | Y502  |
| VB149  | H327   | VB417     | K715       | 9167       | H351       | SBS2040 | K705 | SBS2183 | K602A |
| VB150  | H333   | VB418     | K717       | 9168       | 807        | SBS2041 | H330 | SBS2184 | 882   |
| VB151  | H341   | VB419     | K710       | 9169       | 893        | SBS2042 | H331 | SBS2185 | 881   |
| VB152  | H345   |           |            | 9170       | K715       | SBS2043 | H338 | SBS2186 | 885   |
| VB153  | H342   | <b>DP</b> | <b>EBC</b> | 9171       | -          | SBS2044 | H339 | SBS2187 | 886   |
| VB154  | H331   | 9100      | H303       | 9172       | H350       | SBS2045 | H342 | SBS2188 | 897   |
| VB156  | H347   | 9101      | H304       | 9173       | 806        | SBS2046 | H343 | SBS2189 | H350  |
| VB157  | H351   | 9102      | H310       | 9174       | 810        | SBS2047 | H344 | SBS2190 | Y526  |
| VB158  | H340   | 9103      | H313       | 9175       | 816        | SBS2048 | H346 | SBS2191 | Y525  |
| VB159  | H330   | 9104      | H322       | 9176       | 886        | SBS2049 | Y517 | SBS2182 | Y522  |
| VB206  | Y513   | 9105      | H301       | 9177       | -          | SBS2050 | Y518 | SBS2193 | H335  |
| VB208  | Y510   | 9106      | H302       | 9178       | 899        | SBS2051 | S625 | SBS2194 | H334  |
| VB210  | Y510   | 9107      | Y504       | 9179       | V903       | SBS2052 | S626 | SBS2195 | 899   |
| VB212  | Y504   | 9108      | Y506       | 9180       | -          | SBS2053 | S628 | SBS2196 | 909   |
| VB219  | Y507   | 9109      | Y501       | 9181       | -          | SBS2054 | K717 | SBS2197 | K710  |
| VB220  | Y511   | 9110      | Y502       | 9182       | -          | SBS2056 | K703 | SBS2198 | H351  |
| VB223  | Y506   | 9111      | Y503       | 9184       | 908        | SBS2057 | H333 | SBS2199 | Y527  |
| VB224  | Y501   | 9112      | S602       | 9185       | 885        | SBS2058 | H313 | SBS2200 | 806   |
| VB225  | Y514   | 9113      | S603       | 9186       | H340       | SBS2059 | H321 | SBS2201 | 817   |
| VB226  | Y502   | 9114      | S613       | 9187       | S634       | SBS2060 | K709 | SBS2202 | S635  |
| VB227  | Y512   | 9115      | S601       | 9188       | 860        | SBS2063 | Y512 | SBS2203 | 818   |
| VB228  | Y510   | 9116      | S606       | 9189       | 861        | SBS2064 | Y514 | SBS2204 | 810   |
| VB229  | Y503   | 9117      | K706       | 9190       | H321       | SBS2065 | Y515 | SBS2205 | 816   |
| VB230  | Y515   | 9118      | K709       | 9191       | 815        | SBS2069 | H310 | SBS2207 | H351  |
| VB231  | Y516   | 9119      | H315       | 9192       | H338       | SBS2070 | H325 |         |       |
| VB233  | Y517   | 9120      | H316       | 9193       | 816        | SBS2071 | H314 |         |       |
| VB234  | Y508   | 9121      | H320       | 9194       | 897        | SBS2072 | H316 |         |       |
| VB235  | Y506   | 9122      | H306       | 9195       | Y528       | SBS2074 | H322 |         |       |
| VB238  | Y520   | 9123      | H309       | 9196       | S635       | SBS2075 | H325 |         |       |
| VB239  | Y527   | 9124      | H324       | 9197       | 817        | SBS2077 | H332 |         |       |
| VB240  | Y524   | 9125      | H330       | 9198       | 857        | SBS2080 | H336 |         |       |
| VB302  | K/S602 | 9126      | H333       | 9199       | H352       | SBS2082 | H341 |         |       |
| VB304  | S608   | 9127      | Y511       | 9200       | H346       | SBS2085 | H347 |         |       |
| VB305  | S609   | 9128      | Y514       | 9201       | H307       | SBS2087 | K701 |         |       |
| VB306  | S610   | 9129      | Y512       | 9202       | K718       | SBS2088 | K708 |         |       |
| VB307  | S611   | 9130      | Y510       | 9203       | K719       | SBS2091 | K713 |         |       |
| VB308  | S606   | 9131      | Y515       | 9204       | K720       | SBS2092 | K714 |         |       |
| VB309  | K/S605 | 9132      | Y516       | 9205       | 864        | SBS2093 | K715 |         |       |
| VB310  | S604   | 9133      | S605       | 9206       | S636       | SBS2094 | S601 |         |       |
| VB311  | S617   | 9134      | S604       |            |            | SBS2097 | S609 |         |       |
| VB312  | K/S603 | 9135      | S617       | <b>SBS</b> | <b>EBC</b> | SBS2098 | S634 |         |       |
| VB313  | S613   | 9136      | K704       | SBS2010    | H301       | SBS2099 | S611 |         |       |
| VB314  | S618   | 9137      | S627       | SBS2011    | H302       | SBS2101 | S614 |         |       |

# BRAKE SHOE COMPETITOR INTERCHANGE

| LUCAS  | EBC  | LUCAS  | EBC  |  |  |  |
|--------|------|--------|------|--|--|--|
| MCS800 | H303 | MCS963 | Y519 |  |  |  |
| MCS802 | H315 | MCS964 | Y517 |  |  |  |
| MCS803 | H312 | MCS967 | Y526 |  |  |  |
| MCS804 | H304 | MCS968 | Y527 |  |  |  |
| MCS805 | H318 | MCS969 | Y521 |  |  |  |
| MCS806 | H321 | MCS980 | V903 |  |  |  |
| MCS807 | H313 | MCS981 | V905 |  |  |  |
| MCS808 | H320 | MCS982 | 882  |  |  |  |
| MCS809 | H316 | MCS983 | 881  |  |  |  |
| MCS810 | N/A  | MCS984 | 889  |  |  |  |
| MCS811 | H309 | MCS985 | 896  |  |  |  |
| MCS812 | H323 | MCS986 | V904 |  |  |  |
| MCS813 | H302 | MCS987 | 885  |  |  |  |
| MCS815 | H332 | MCS988 | 908  |  |  |  |
| MCS816 | H327 | MCS989 | 806  |  |  |  |
| MCS817 | H310 | MCS990 | 897  |  |  |  |
| MCS819 | H330 | MCS991 | S632 |  |  |  |
| MCS820 | H336 | MCS993 | S615 |  |  |  |
| MCS821 | H340 | MCS994 | 816  |  |  |  |
| MCS822 | H343 | MCS995 | H351 |  |  |  |
| MCS824 | H344 | MCS996 | N/A  |  |  |  |
| MCS825 | H333 |        |      |  |  |  |
| MCS827 | H301 |        |      |  |  |  |
| MCS828 | H322 |        |      |  |  |  |
| MCS831 | H350 |        |      |  |  |  |
| MCS832 | H338 |        |      |  |  |  |
| MCS833 | Y511 |        |      |  |  |  |
| MCS834 | Y512 |        |      |  |  |  |
| MCS850 | H316 |        |      |  |  |  |
| MCS851 | K713 |        |      |  |  |  |
| MCS852 | K709 |        |      |  |  |  |
| MCS853 | K706 |        |      |  |  |  |
| MCS854 | S603 |        |      |  |  |  |
| MCS855 | S602 |        |      |  |  |  |
| MCS856 | S617 |        |      |  |  |  |
| MCS857 | K715 |        |      |  |  |  |
| MCS858 | K711 |        |      |  |  |  |
| MCS861 | K703 |        |      |  |  |  |
| MCS890 | 978  |        |      |  |  |  |
| MCS891 | 979  |        |      |  |  |  |
| MCS892 | H320 |        |      |  |  |  |
| MCS901 | S604 |        |      |  |  |  |
| MCS902 | S605 |        |      |  |  |  |
| MCS904 | S609 |        |      |  |  |  |
| MCS905 | S634 |        |      |  |  |  |
| MCS906 | S611 |        |      |  |  |  |
| MCS907 | S606 |        |      |  |  |  |
| MCS915 | S616 |        |      |  |  |  |
| MCS918 | S627 |        |      |  |  |  |
| MCS919 | S606 |        |      |  |  |  |
| MCS920 | 804  |        |      |  |  |  |
| MCS921 | S624 |        |      |  |  |  |
| MCS940 | 860  |        |      |  |  |  |
| MCS941 | 861  |        |      |  |  |  |
| MCS942 | 862  |        |      |  |  |  |
| MCS943 | 863  |        |      |  |  |  |
| MCS944 | 864  |        |      |  |  |  |
| MCS945 | 859  |        |      |  |  |  |
| MCS950 | Y512 |        |      |  |  |  |
| MCS951 | Y504 |        |      |  |  |  |
| MCS952 | Y511 |        |      |  |  |  |
| MCS953 | Y506 |        |      |  |  |  |
| MCS954 | Y513 |        |      |  |  |  |
| MCS955 | Y510 |        |      |  |  |  |
| MCS956 | Y518 |        |      |  |  |  |
| MCS957 | Y515 |        |      |  |  |  |
| MCS958 | Y516 |        |      |  |  |  |
| MCS959 | N/A  |        |      |  |  |  |
| MCS960 | Y501 |        |      |  |  |  |
| MCS961 | Y502 |        |      |  |  |  |
| MCS962 | Y503 |        |      |  |  |  |

# CLUTCH KITS FOR STREET/DIRT/ATV

## STREET - 2 choices

### 1. Standard - CK Series

Almost identical to original equipment clutch plates the CK series are a cork based product impregnated with aluminum particles to increase wear life and heat resistance. Material is highly compressed to avoid swell and clutch drag and is an ideal general purpose replacement material for all grades and sizes of motorcycle. Kit includes a complete "engine set" of friction plates only.



### 2. Race/Sport

#### SRC Kevlar Series

A Kevlar paper lined plate set complete with heavy duty clutch springs<sup>1</sup>, the SRC kit is ideal for heavy sport bikes, faster riders and production based race use. Advantages of the SRC Kevlar series are longer life, higher heat resistance, although this clutch has a more aggressive/faster take up than the CK cork series. (Does not include steel plates)

<sup>1</sup> If bike has a diaphragm type spring fitted as standard we cannot supply this type of spring.



## DIRT/ATV - 3 choices



### 1. Standard - CK Series

Cork based replacement clutch exactly the same as used on the street series CK clutch plates described above. A general all purpose replacement unit.



### 2. Full Kit - DRC Series

EBC DIRT RACER clutch sets are a complete set of CK series heavy duty cork based lined plates plus heavy duty clutch springs and steel separator plates. Many off road machines are fitted from new with alloy separator plates which wear out quickly and cause clutch to slip. The steel units in the EBC DRC kit prevent this and re-establish original clutch stack height.



### 3. Race - 'EP' Kevlar Series

A complete kit with Kevlar lined friction plates, steel separator plates and heavy duty clutch springs. The EP kit is a heavy duty high temperature resistant clutch, suitable for sport/race use in Moto-X and ATV applications. For 1998 some models have been upgraded to have lined plates using a steel carrier body which should be located closest to the inboard or engine side of the clutch and compensate for overload fractures which happen when the clutch basket wears or "spreads". Denoted by 'S' suffix after part#.

**IMPORTANT NOTE: WE DO NOT RECOMMEND THE USE OF FULLY SYNTHETIC OILS WITH THESE CLUTCH KITS**

## EBC "EP" KITS The STRONGEST off Road Clutches money can buy - in KEVLAR

EBC new "EP" KITS are built with US MADE Dupont Kevlar fibre friction plates - High Durability STEEL intermediate plates to prevent early wear and distortion BUT as a world FIRST we give you a Extra steel and Extra friction plate in every set. With Alloy drive fingers these plates wont "dog" your clutch basket plus with 15% more friction area you get better drive and the high heat resistance of KEVLAR facings. New Destressed drive plates reduce chance of fracture in toughest conditions.

SELECT CORRECT SET No. FROM PREVIOUS "DRC" SECTION AND SEE BELOW FOR KITS AVAILABILITY IN "EP" CONSTRUCTION.

| DRC      | CUST # | DRC      | CUST # | DRC       | CUST # | DRC       | CUST # |
|----------|--------|----------|--------|-----------|--------|-----------|--------|
| DRC1 EP  |        | DRC36 EP |        | DRC75 EP  |        | DRC101 EP |        |
| DRC2 EP  |        | DRC39 EP |        | DRC76 EPS |        | DRC102 EP |        |
| DRC5 EP  |        | DRC41 EP |        | DRC78 EP  |        | DRC114 EP |        |
| DRC10 EP |        | DRC46 EP |        | DRC80 EP  |        | DRC115 EP |        |
| DRC15 EP |        | DRC48 EP |        | DRC81 EP  |        | DRC122 EP |        |
| DRC24 EP |        | DRC69 EP |        | DRC85 EP  |        | DRC123 EP |        |
| DRC25 EP |        | DRC70 EP |        | DRC95 EP  |        | DRC130 EP |        |
| DRC27 EP |        | DRC71 EP |        | DRC97 EP  |        |           |        |
| DRC30 EP |        | DRC72 EP |        | DRC99 EP  |        |           |        |
| DRC31 EP |        | DRC73 EP |        | DRC100 EP |        |           |        |



### CSK Spring Kits

Always fit new springs which get tired after miles of heat and use.

EBC spring kits are 10% stiffer than standard and are sold in engine sets.

As stated in general fitting/safety instructions, advise customers that lever will feel slightly 'heavier' when uprating springs, and to test ride/acquaint themselves with this change in control.

NOTE- IN SOME CASES YOU MAY END UP WITH 1 OR 2 EXTRA SPRINGS - THIS IS DUE TO SOME BIKES USING THE SAME SPRINGS BUT IN DIFFERENT AMOUNTS.

# EBC CLUTCH KITS

## EBC HEAVY DUTY CLUTCHES & SPRINGS



EBC Clutches are totally Asbestos Free made from a cork based "anti-swell" facing impregnated with aluminium particles to reduce wear & heat fade. Kits are sold in pre-measured engine sets and should always be replaced in engine sets. **USE ONLY MANUFACTURERS Drive case oils and avoid lead or other anti-friction additives. DO NOT USE FULLY SYNTHETIC OILS. SOAK PLATES in drive case oil before installing. EBC Clutch Springs are 10-15% stiffer than stock springs to avoid slip. Always check lever operating pressure for ease of clutch disengagement before riding or releasing motorcycle for use.**

### CAUTION - SAFETY WARNINGS FOR CONSUMERS

The following warnings now appear on the underside of our clutch packaging. For stocks in older packaging that do not display these safety warnings, we strongly recommend you photocopy these essential points and advise customers. Never start a motorcycle whilst in gear with clutch depressed. Never reverse a motorcycle with the engine running, the machine in gear and clutch depressed. Hold front brake lever on when selecting gears from standstill. Never engage gears from a standstill with engine revs above 1500 rpm. Check oil levels regularly. When fitting heavy duty clutch springs acquaint yourself with increased hand pressure required to depress clutch before riding motorcycle.

CLUTCH APPLICATIONS

| MAKE & MODEL                  | YEAR  | CLUTCH KIT NO. | SPRING KIT NO. | DRC/SRC SERIES | MAKE & MODEL                     | YEAR  | CLUTCH KIT NO. | SPRING KIT NO. | DRC/SRC SERIES |
|-------------------------------|-------|----------------|----------------|----------------|----------------------------------|-------|----------------|----------------|----------------|
| <b>HONDA</b>                  |       |                |                |                | <b>HONDA Cont..</b>              |       |                |                |                |
| C 50 M/C 50                   | -78   | CK1107         | CSK44          |                | CR 80 RF/R2F                     | 85    | CK1119         | CSK4           | DRC1■          |
| C 50 Z2/ZZ/ZA                 | 78-81 | CK1148         | CSK44          |                | CR 80 RG/R2G                     | 86    | CK1119         | CSK4           | DRC1■          |
| C 50 All models               | 82-93 | CK1148         | N/A            |                | CR 80 RH/RJ/RK/RL/RM/RN/RP/RR/RS |       |                |                |                |
| C 50 (Single seat model)      | 95    | CK1148         | N/A            |                | /RT/RBT/RV/RBV/RW/RBW/RX/RBX     |       |                |                |                |
| C 50 P/S/N/X/Y/1/2            | 96-02 | CK1148         | N/A            |                | /RY/RBY/R1/RB1/R2/RB2            | 87-02 | CK1119         | CSK4           | DRC1■          |
| CB 50 J                       | 81    | CK1150         | CSK3           |                | CRF 80 F4/F5/F6/F7               | 04-07 | CK1150         | CSK48          |                |
| CB 50 V/W Dream 50            | 97-98 | CK1150         | CSK48          |                | MBX 80 FWDD/FWDF                 | 83-86 | CK1151         | CSK3           |                |
| CD 50 ST/SV/SW/SX Benley 50 S | 96-99 | CK1105         | N/A            |                | MTX 80 RFD/RFF                   | 83-84 | CK1151         | CSK3           |                |
| CF 50/CF 50 K2                | 77-78 | CK1148         | CSK44          |                | NSR 80 J-2/K/L/N/P/R/S (HC06)    | 88-   | CK1151         | CSK3           |                |
| CL 50 V/X Benley CL 50        | 97-99 | CK1105         | N/A            |                | XR 80 Z/A/B                      | 80-81 | CK1150         | CSK22          |                |
| CR 50 RE-RF                   | 84-85 | CK1151         | CSK3           |                | XR 80 R                          | 87-88 | CK1150         | CSK8           |                |
| CRF 50 F4/F5/F6/F7            | 04-06 | CK1148         | N/A            | SRC90          | CR 85 R3/RB3/R4/RB4/R5/RB5       |       |                |                |                |
| CRM 50 RN/RP/RR/RT            | 93-96 | CK1150         | CSK3           |                | /R6/RB6/R7/RB7                   | 03-07 | CK1119         | CSK4           | DRC1■          |
| MB 50                         | 80-82 | CK1150         | CSK3           |                | C 90 (from frame no A073285      |       |                |                |                |
| MTX 50 SC                     | 83-87 | CK1150         | CSK3           |                | /Z2/ZZ)                          | 75-81 | CK1156         | N/A            |                |
| MBX 50 SD/SF                  | 83-85 | CK1150         | CSK3           |                | C 90 C/E/G/MF/P/MP/MG/N/MN       |       |                |                |                |
| MP 50 3/DX3 (AC17) Solo       | 03    | CK1148         | N/A            |                | /P/MP/T/MT                       | 82-03 | CK1148         | N/A            |                |
| MT 50 SA/SE/SG/SJ/SL          | 80-93 | CK1150         | CSK3           |                | TRX 90 P/R/S/T/V/W/X/Y/1-6       | 93-06 | CK1151         | N/A            |                |
| NSR 50 FP/FR/FS               | 93-95 | CK1150         | CSK3           |                | TRX 90 EX                        | 07    | CK1151         | N/A            |                |
| NSR 50 RV/RW/RX/RY            | 97-00 | CK1150         | CSK3           |                | Astrea Supra NF100               | 99    | CK1151         | N/A            |                |
| NSR 50 SK/SP/SR/SS            | 89-95 | CK1150         | CSK3           |                | Astrea Grand/Supra (Drum model)  | 97-98 | CK1151         | N/A            |                |
| SS 50 ZK2/ZB2                 | 75-80 | CK1105         | N/A            |                | CB 100 N                         | 78-80 | CK1119         | CSK4           |                |
| ST 50 J/K "DAX"               | 78-93 | CK1148         | N/A            |                | CRF 100 F4/F5/F6/R7              | 04-07 | CK1151         | CSK23          | DRC49          |
| TLM 50 F                      | 85    | CK1150         | CSK31          |                | H 100 A/SD/SG/SJ                 | 84-92 | CK1151         | CSK3           |                |
| XR 50 R1/R2/R3                | 01-03 | CK1148         | N/A            |                | XL 100 SZ/SA                     | 78-80 | CK1151         | CSK48          |                |
| XR 50 M5 (AD14) Motard        | 06    | CK1150         | CSK48          |                | XL 100 SB                        | 81-82 | CK1151         | CSK22          |                |
| XZ 50 1/2 APE-AC16            | 01-02 | CK1150         | CSK48          |                | XR 100 RP/RR/RS/RT/RV/RW/RX      |       |                |                |                |
| Z 50 RZ/RA-RD                 | 79-86 | CK1107         | CSK44          |                | /RY/R1/R2/R3                     | 93-03 | CK1151         | CSK23          | DRC49          |
| CR 60 RF/RG                   | 85-86 | CK1151         | CSK3           |                | XR 100 M5 (HD13) Motard          | 06    | CK1151         | TBA            |                |
| ATC 70 all Models             | 78-85 | CK1148         | CSK18          |                | XZ 100 2 APE-HC07                | 02    | CK1151         | N/A            |                |
| C 70/C 70 M                   | -78   | CK1107         | N/A            |                | ATC 110 All models               | 79-84 | CK1156         | CSK18          |                |
| C 70 Z2/ZZ/C/D/DMC            | 78-85 | CK1148         | CSK18          |                | CT 110 K/M/P                     | 89-93 | CK1156         | N/A            |                |
| CF 70 C                       | 77-78 | CK1148         | CSK18          |                | CT 110 X                         |       | TBA            | TBA            |                |
| CRF 70 F4/F5/F6/F7            | 04-07 | CK1148         | CSK18          |                | ANF 125 3/5/T5/6/7 Innova        | 03-07 | CK1307         | N/A            |                |
| XR 70 RV/RW/RX/RY/R1/RY/R1-R3 | 97-03 | CK1148         | CSK18          |                | ATC 125 ME                       | 84    | CK1156         | CSK21          |                |
| CRM 75 RK/RL/RM/RP/RR         | 89-94 | CK1151         | CSK3           |                | ATC 125 MG                       | 86    | CK1151         | CSK48          |                |
| NSR 75 N/P/R/X/Y (NS-1)       | 92-00 | CK1151         | CSK3           |                | CA 125 Rebel V/W/X               | 98-00 | CK1151         | CSK84          |                |
| XR 75 K4/K5                   | 78-79 | CK1150         | CSK22          |                | CA 125 S/T                       | 95-96 | CK1252         | CSK84          |                |
| CR 80 RA/RB/RC                | 80-82 | CK1151         | CSK3           |                | CB 125 S/J                       | 75-79 | CK1119         | CSK4           |                |
| CR 80 RD                      | 83    | CK1151         | CSK23          |                | CB 125 T/T2                      | 78-80 | CK1119         | CSK84          |                |
| CR 80 RE                      | 84    | CK1119         | CSK23          |                | CB 125 TDC/TDE                   | 83-86 | CK1119         | CSK84          |                |

# EBC CLUTCH KITS

CLUTCH APPLICATIONS

| MAKE & MODEL                   | YEAR  | CLUTCH KIT NO. | SPRING KIT NO. | DRC/SRC SERIES | MAKE & MODEL                      | YEAR  | CLUTCH KIT NO. | SPRING KIT NO. | DRC/SRC SERIES |
|--------------------------------|-------|----------------|----------------|----------------|-----------------------------------|-------|----------------|----------------|----------------|
| <b>HONDA Cont..</b>            |       |                |                |                | <b>HONDA Cont..</b>               |       |                |                |                |
| CB 125 TDJ                     | 87-89 | CK1252         | CSK84          |                | ATC 250 RB/RC/RD                  | 81-83 | CK1163         | CSK31          |                |
| CB 125 RS                      | 83    | CK1119         | CSK4           |                | ATC 250 RF                        | 85    | CK1193         | CSK15          |                |
| CBR 125 R/R4/R5/RS5/RW5/RR6    |       |                |                |                | ATC 250 RG                        | 86    | CK1193         | CSK32          |                |
| /RS6/R7                        | 04-07 | CK1252         | CSK105         |                | ATC 250 ESF/ESG/ESH/ESJ           | 85-88 | CK1194         | CSK4           |                |
| CD 125 TC                      | 78    | CK1119         | CSK84          |                | AX-1 (NX 250 J/K/R/R3)            | 89-94 | CK1190         | CSK30          |                |
| CG 125 K1/B/C/E/BR/BR-K/BR-KJ/ |       |                |                |                | NX 250 J/K/L (MD21)               | 87-90 | CK1190         | CSK65          |                |
| S/T/W                          | 77-00 | CK1119         | CSK4           |                | NX 250 2L/M/P/2P                  | 90-93 | CK1190         | CSK65          |                |
| CG 125 M1/1                    | 01-03 | CK1252         | CSK41          |                | TRX 250 F/G/H                     | 85-87 | CK1194         | CSK4           |                |
| CG 125 ES4                     | 04-07 | CK1252         | CSK41          |                | TRX 250 RG/RH                     | 86-87 | CK1193         | CSK32          | DRC5■          |
| CG 125 Job                     | 05    | TBA            | TBA            |                | TRX 250 RJ/RK                     | 88-89 | CK1193         | CSK45          | DRC81■         |
| CLR 125 W 'City Fly'           | 98-03 | CK1119         | CSK9           |                | TRX 250 V/W/X/Y Re-Con            | 97-   | CK1119         | CSK9           |                |
| CM 125 CC/CF                   | 82-85 | CK1119         | CSK9           |                | CB 250 K3-K5                      | 73-75 | CK1132         | CSK4           |                |
| CT 125 C                       | 85    | CK1119         | CSK4           |                | CB 250 G5                         | 75-76 | CK1132         | CSK4           |                |
| CR 125 M2-M4                   | 76-78 | CK1144         | CSK36          |                | CB 250 T/N/NA/NB/NDB/NDC          | 78-82 | CK1140         | CSK6           |                |
| CR 125 RZ/RA                   | 79-80 | CK1199         | CSK31          |                | CB 250 RSA/RSD                    | 81-84 | CK1153         | CSK9           |                |
| CR 125 RB                      | 81    | CK1191         | CSK31          |                | CB 250 N/T/W/X/Y1/4 "Two Fifty"   | 93-05 | CK1191         | CSK24          |                |
| CR 125 R4                      | 04    | CK1293         | CSK77          | DRC101■        | CB 250 FT/FV/FX/FY/F1             |       |                |                |                |
| CR 125 RC                      | 82    | CK1186         | CSK31          |                | (MC31) 'Hornet'                   | 96-01 | CK1235         | CSK9           |                |
| CR 125 RD/RE                   | 83-84 | CK1190         | CSK24          | DRC67          | CBF 250 4                         | 04-06 | CK1190         | TBA            |                |
| CR 125 RF                      | 85    | CK1200         | CSK24          | DRC68          | CBR 250 FG/RH/RJ/RK/RK2           | 86-89 | CK1235         | CSK9           |                |
| CR 125 RG/RH/RJ/RK/RL/RM/RN/RP |       |                |                |                | CBR 250 RRL/RRN/RRR               | 90-94 | CK1235         | CSK9           |                |
| /RR/RS/RT/RV/RW/RX             | 86-99 | CK1222         | CSK24          | DRC2■          | CBX 250 RSE                       | 84    | CK1217         | CSK7           |                |
| CR 125 RY/R1/R2/R3/R4/R5/R6/R7 | 00-07 | CK1293         | CSK77          | DRC101■        | CBX 250 Twister                   |       | TBA            | TBA            |                |
| CRM 125 RL/RM/RN/RP/RR/        |       |                |                |                | CBX 250                           | 84-98 | TBA            | CSK106         |                |
| RV/RX                          | 90-99 | CK1160         | CSK4           |                | CD 250 UJ/UK                      | 88-92 | CK1191         | CSK24          |                |
| LS 125 R                       | 00-   | CK1252         | CSK105         |                | CJ 250 T/T2                       | 77    | CK1132         | CSK31          |                |
| MTX 125 RWD/E/F/H/L            | 83-95 | CK1180         | CSK4           |                | CL 250 SC                         | 81    | CK1153         | CSK9           |                |
| MBX 125 FE                     | 84-86 | CK1180         | CSK9           |                | CM 250 TB                         | 81    | CK1140         | CSK16          |                |
| NS 125 FG/FH/RH                | 86-90 | CK1153         | CSK6           |                | CMX 250 CT/CV/CW/CX               | 96-00 | CK1191         | CSK24          |                |
| NSR 125 FM/RK/RL/RM/RN/RR      |       |                |                |                | VT 250 FD                         | 83    | CK1191         | CSK23          |                |
| /RP/FP/RV/RW/RX/RY/R1          | 90-04 | CK1160         | CSK6           |                | VT 250 FL Spada/Castec            | 88-90 | CK1235         | CSK9           |                |
| NX 125 K/S/F Transcity         | 89-97 | CK1119         | CSK41          |                | CR 250 R/RZ/RA                    | 78-80 | CK1163         | CSK31          |                |
| NXR 125 Bros ES/KS             | 05    | TBA            | TBA            |                | CR 250 RB/RC                      | 81-82 | CK1131         | CSK41          |                |
| TL 125 S                       | 76    | CK1119         | CSK4           |                | CR 250 RD/RE/RF/RG/RH/RJ/RK       | 83-89 | CK1170         | CSK28          | DRC3           |
| TRX 125 J                      | 88    | CK1151         | CSK48          |                | CR 250 RL/RM/RN/RP                | 90-93 | CK1247         | CSK28          | DRC75■         |
| VT 125 CX/CY/C2Y/C1/C21        |       |                |                |                | CR 250 RR/RS/RT/RV/RW/RX/RY/R1-R7 | 94-07 | CK1247         | CSK32          | DRC79■         |
| /C3/C4/C7 'Shadow'             | 99-07 | CK1292         | CSK33          |                | CRF 250 R4/R5/R6/R7               | 04-07 | CK1293         | CSK77          | DRC129         |
| XL 125 K2-K4/SZ/SA             | 78-79 | CK1119         | CSK4           |                | CRM 250 R (RK) MK1 MD24           |       |                |                |                |
| XL 125 SB/SC/SZ/SA             | 79-82 | CK1119         | CSK31          |                | (100001-1008385)                  | 89-90 | CK1193         | CSK28          | DRC93          |
| XL 125 RC/RF/RH                | 83-86 | CK1119         | CSK9           |                | CRM 250 R (RM) MK2 MD24           |       |                |                |                |
| XL 125 Varadero V1-V7          | 01-07 | CK1292         | CSK33          |                | (1200001-1211634)                 | 91-92 | CK1193         | CSK28          | DRC93          |
| XLR 125 RW                     | 98-99 | CK1119         | CSK9           |                | CRM 250 R (RP/PP-11) MK2/2/MD24   |       |                |                |                |
| XR 125 L3/L4/L5/L6/L7          | 03-07 | CK1119         | CSK4           |                | (1300001-)                        | 93    | CK1193         | CSK28          | DRC93          |
| CBR 150 R                      | 00-   | CK1252         | CSK105         |                | CRM 250 MK3                       | 95-96 | CK1181         | CSK28          |                |
| CRF 150 F3/F4/F5               | 03-05 | CK1304         | CSK77          | DRC180         | CRM 250 "Active Radial"           |       |                |                |                |
| CRF 150 F6/F7                  | 06-07 | CK1119         | CSK6           | DRC181         | ARV/ARW (MD32)                    | 97-98 | CK1181         | TBA            |                |
| CRF 150 RB7/R7                 | 07    | CK1191         | CSK134         | DRC182         | GB 250 E/H/J/L/P/S/V 'Custom'     | 84-97 | CK1217         | CSK7           |                |
| CB 175 all Models              |       | CK1134         | CSK8           |                | MXV 250 F (MC92)                  | 83-88 | N/A            | N/A            |                |
| CD 175 all Models              |       | CK1134         | CSK8           |                | NSR 250 RG/R2J (MC16/18)          | 86-88 | CK1181         | CSK9           |                |
| CD 185 T                       | 78    | CK1119         | CSK9           |                | NSR 250 RSP/RSK (MC18)            |       | CK1181         | CSK9           |                |
| ATC 185 A/SB/SC/SD             | 80-83 | CK1151         | CSK22          |                | NSR 250 RSP (R6KII)               |       | CK1288         | TBA            |                |
| XL 185 SZ/SA/SB                | 80-81 | CK1119         | CSK41          |                | NSR 250 R7L/R7N (MC21-106)        | 95-   | CK1181         | CSK9           |                |
| XL 185 SB                      | 82    | CK1119         | CSK65          |                | NSR 250 RSP (MC21)                |       | CK1288         | TBA            |                |
| ATC 200 B/ESE/ESF/SE/XD        | 81-85 | CK1151         | CSK22          |                | NSR 250 RR (MC28)                 |       | CK1181         | CSK9           |                |
| CB 200/CB 200 B                | 76-78 | CK1134         | CSK8           |                | NSR 250 R2R/R2T/R3R/R3S           |       |                |                |                |
| CBX 200 Strada                 | 97-01 | TBA            | TBA            |                | /R3T (MC28)                       |       | CK1288         | TBA            |                |
| CD 200 TA                      | 79-80 | CK1119         | CSK24          |                | NS 250 FE (MC11)                  | 84    | CK1218         | CSK20          |                |
| CM 200 TA/TB                   | 79-80 | CK1119         | CSK24          |                | NS 250 RE/RG (MC11)               | 84-86 | CK1218         | CSK20          |                |
| CTX 200/CTX 200 A Bushlander   | 04-05 | CK1119         | CSK105         | DRC91          | TL 250/TL 250 K1                  | 78-79 | CK1131         | CSK4           |                |
| MTX 200 RWD                    | 83-84 | CK1217         | CSK9           |                | TLR 250 F                         | 85-   | CK1119         | CSK105         | DRC91          |
| MTX 200 RWF                    | 85    | CK1180         | CSK4           |                | TRX 250 EX1/EX2                   |       |                |                |                |
| TA 200 (TA Shadow)             | 02-05 | CK1252         | TBA            |                | (Sportrax 250 EX)                 | 01-02 | CK1119         | CSK9           | DRC4           |
| TL 200 J/Y                     | 76-78 | CK1119         | CSK4           |                | TRX 250 V/W/X/Y1/TE2-7/TM2-7      |       |                |                |                |
| TLR 200 D/E/G/H                | 83-87 | CK1119         | CSK9           |                | Recon/ES                          | 97-07 | CK1119         | CSK9           | DRC4           |
| TRX 200 L/M/DM/DN              | 90-93 | CK1119         | CSK9           |                | TRX 250 EX1/2/3/4/5/6/7           | 01-07 | CK1119         | CSK9           | DRC4           |
| XR 200 R                       | 81-83 | CK1119         | CSK105         | DRC91          | VT 250 CR 'Magna'                 |       | CK1235         | CSK9           |                |
| XR 200 R                       | 84-85 | CK1180         | CSK106         | DRC60          | VTZ 250 H/J/K                     | 86-88 | CK1235         | CSK9           |                |
| XR 200 R                       | 86-02 | CK1119         | CSK105         | DRC91          | VTR 250 W/Y (MC33)/1-7            | 98-07 | CK1235         | CSK9           |                |
| XR 200                         | 80-84 | CK1119         | CSK105         | DRC91          | XL 250 K3/K4                      | 78-79 | CK1131         | CSK4           |                |
| FTR 223 Y/2/A2 (MCS4)          | 00-02 | CK1252         | TBA            |                | XL 250 S/SZ/SA                    | 78-80 | CK1152         | CSK9           |                |
| CRF 230 F4/F5/F6/F7            | 04-07 | CK1304         | CSK24          | DRC136         | XL 250 SB/RC                      | 81-82 | CK1153         | CSK9           |                |
| SL 230 V/W/X/1                 | 97-01 | CK1252         | TBA            |                | XL 250 RE/RF                      | 84-85 | CK1180         | CSK4           | DRC60          |
| XL 230 2 (MC36)                | 02    | CK1252         | TBA            |                |                                   |       |                |                |                |



# EBC CLUTCH KITS

| MAKE & MODEL                         | YEAR  | CLUTCH KIT NO. | SPRING KIT NO. | DRC/SRC SERIES | MAKE & MODEL                      | YEAR  | CLUTCH KIT NO. | SPRING KIT NO. | DRC/SRC SERIES |
|--------------------------------------|-------|----------------|----------------|----------------|-----------------------------------|-------|----------------|----------------|----------------|
| <b>HONDA Cont.</b>                   |       |                |                |                | <b>HONDA Cont.</b>                |       |                |                |                |
| XL 250 Degree                        |       | CK1190         | CSK9           |                | CBR 500 FH/FJ/FK/FL               | 87-90 | CK1228         | CSK12          | SRC16          |
| XLR 250 R Baja (5 Plate) (MD22)      |       | CK1180         | CSK4           | DRC60          | CR 500 RE/RG/RH/RJ/RK             | 84-89 | CK1170         | CSK28          | DRC3           |
| XLR 250 R Baja (6 Plate) (MD22)      |       | CK1190         | CSK4           |                | CR 500 RL/RM/RN/RP/RR/RS          |       |                |                |                |
| XR 250 SZ/SA                         | 79-80 | CK1152         | CSK9           |                | /RT/RV/RW/RX/RY/R1                | 90-01 | CK1247         | CSK28          | DRC75■         |
| XR 250 RB/RC/RD                      | 81-83 | CK1153         | CSK9           |                | CX 500 CA/CB/Z/A/B/EC             | 79-85 | CK1146         | CSK41          |                |
| XR 250 RE/RF                         | 84-85 | CK1180         | CSK4           | DRC60          | CX 500 Turbo                      | 82    | CK1159         | CSK10          |                |
| XR 250 RG/RH/RJ/RK/RL/RM/RN/RP/RR/RS | 86-95 | CK1190         | CSK4           | DRC44          | FT 500 C                          | 82    | CK1154         | CSK15          |                |
| XR 250 RT/RV/RW/RX/RY/R1/R2/R3/R4    | 96-04 | CK1190         | CSK65          | DRC84          | GL 500 DC                         | 82    | CK1146         | CSK41          |                |
| XR 250 Tornado                       | 05    | TBA            | TBA            |                | NX 500 J/K/L/M/N/P/R/S/T/V        |       |                |                |                |
| XR 250 Y/3 (MD30)                    | 00-03 | CK1190         | CSK65          |                | /W/X Dominator                    | 88-99 | CK1170         | CSK16          | DRC54          |
| XR 250 3/5 (MD30) Motard             | 03-05 | CK1190         | CSK65          |                | VF 500 FE/F2E/FF/F2F              | 84-85 | CK1177         | CSK9           |                |
| XR 250 III Y/3 Baja                  | 00-03 | CK1190         | CSK65          |                | VT 500 ED/EF                      | 83-85 | CK1160         | CSK16          |                |
| TRX 300 FW/J/K/L/T/V/W/X/Y/J/K       |       |                |                |                | XBR 500 F/G/H/SH/SJ               | 85-89 | CK1219         | CSK16          |                |
| IL/T/V/W/X/Y                         | 88-00 | CK1196         | CSK23          | DRC6           | XL 500 SZ/SB/RC                   | 80-82 | CK1140         | CSK15          |                |
| TRX 300 EX P/R/S/T/V/W/X/Y/1-7       | 93-07 | CK1190         | CSK4           | DRC44          | XR 500 SZ/SA/RB/RC                | 79-82 | CK1154         | CSK15          |                |
| TRX 350 G/H/J/K/L/M/N                | 86-93 | CK1196         | CSK12          | DRC6           | XR 500 RD/RE                      | 84-85 | CK1170         | CSK15          |                |
| TRX 350 FMY/1-5 Fourtrax             |       |                |                |                | CB 550 F/F1/F2/K3                 | 78-80 | CK1146         | CSK9           |                |
| Rancher/4x4                          | 00-05 | CK1196         | CSK48          | DRC126         | CBX 550 FC/F2C/FD/F2D             | 82-85 | CK1228         | CSK26          |                |
| TRX 350 TE/FE Fourtrax               |       |                |                |                | CB 600 'Hornet' FW/FX/FY/F2-Y     |       |                |                |                |
| Rancher ES/ES 4x4 FEY/1-5            | 00-05 | CK1160         | CSK48          | DRC127         | F1/F21/F2/F22/F3/F4/F5/F6         | 98-07 | CK1206         | CSK45          | SRC19          |
| CB 350 SG/SJ                         | 86-88 | CK1140         | CSK15          |                | CB 600 F7 Hornet                  | 07    | TBA            | TBA            |                |
| CB 350 K4                            |       | CK1132         | CSK3           |                | CB 600 AF7 Hornet (ABS)           | 07    | TBA            | TBA            |                |
| XR 350 RD/RE                         | 83-84 | CK1190         | CSK4           | DRC44          | CBR 600 FH/FJ                     | 87-88 | CK1228         | CSK12          | SRC16          |
| CB/CJ 360 all models                 |       | CK1132         | CSK82          |                | CBR 600 FK/FL                     | 89-90 | CK1228         | CSK47          | SRC42          |
| CB 400 F/F1/F2                       | 75-79 | CK1140         | CSK82          |                | CBR 600 FM/FN/FP/FR/FS            |       |                |                |                |
| CB 400 T/N/NA/NB/NC                  | 78-82 | CK1140         | CSK47          |                | /FT/FV/FW                         | 91-98 | CK1206         | CSK45          | SRC19          |
| CB-1 (CB400F)                        | 89-90 | CK1228         | CSK6           |                | CBR 600 FX/FY/F1                  | 99-01 | CK1193         | CSK29          | SRC66          |
| CB 400 SF (F2N/F2R) (Super Four)     | 92-   | CK1228         | CSK6           |                | CBR 600 F2/F3/F4/F5/F6/F7         | 02-07 | CK1218         | CSK45          | SRC57          |
| CB 400 SF (F2V/F3T) Superfour        | 96-97 | CK1228         | CSK6           |                | CBR 600 FS1/FS2 'Sport'           | 01-02 | CK1218         | CSK45          | SRC57          |
| CB 400 SF (F3V) Superfour            | 97    | CK1228         | CSK6           |                | CBR 600 RR3/RR4/RR5/RR6           | 03-06 | CK1218         | CSK101         | SRC75          |
| CB 400 Four V/V-II/W/W-II (NC36)     | 97-98 | CK1228         | TBA            |                | CBR 600 RR7                       | 07    | TBA            | TBA            |                |
| CB 400 SS (CB 400 SS2-J/SS2-3J-NC41) | 01    | CK1181         | CSK32          |                | CBF 600 N4/NA4/S4/SA4/N5/NA5/S5   |       |                |                |                |
| CB 400 SFX/SFY/SF1/SF2/SF3/SF4/5/S5  |       |                |                |                | /SA5/N6/NA6/SA6/SA7               | 04-07 | CK1206         | CSK45          | SRC19          |
| (NC39) Super Four                    | 99-05 | CK1265         | TBA            |                | NTV 600 J/K/M                     | 88-91 | CK1230         | CSK32          |                |
| CBR 400 RG/RHYA (NC23 100/101)       | 86    | CK1228         | TBA            |                | VT 600 CN/CR/CS/CT/CV/CW/CX       | 92-00 | CK1181         | CSK33          |                |
| CBR 400 RRJ/RRK (NC23 102/109)       | 92-93 | CK1228         | CSK6           |                | XL 600 RD/LD/RE/LE/RF/RG/RH       | 83-87 | CK1170         | CSK15          | DRC92          |
| CBR 400 RRL/RRN/RRR (NC29)           | 90-94 | CK1181         | CSK33          |                | XL 600 LMF                        | 85    | CK1170         | CSK16          | DRC54          |
| FL 400 R/RK/RL 'Pilot'               | 89-93 | CK1234         | TBA            |                | XL 600 VH/VJ/VK/VM/VN/VP          |       |                |                |                |
| NS 400 RF/RG                         | 85-87 | CK1218         | CSK9           |                | /VR/VT/VV/VW/VX Transalp          | 87-99 | CK1181         | CSK33          | DRC53          |
| NT 400 "Bros" NC 25                  |       | CK1160         | CSK28          | SRC61          | XR 600 RF/RG/RH/RJ/RK/RL/RM/RP    |       |                |                |                |
| NV 400 CJ/CK (Steed)                 | 92-93 | CK1160         | CSK28          | SRC61          | /RR/RS/RT/RV/RW/RX/RY             | 84-00 | CK1170         | CSK16          | DRC54          |
| NV 400 CS/CV Steed                   | 95-97 | CK1160         | CSK28          | SRC61          | FMX 650 5/6                       | 05-06 | CK1170         | CSK16          | DRC54          |
| NV 400 DCY/DC1/DC2 (NC40)            |       |                |                |                | FX 650 X/Y 'Vigor'                | 99-03 | CK1170         | CSK16          | DRC54          |
| Shadow Slasher                       | 00-02 | CK1160         | CSK28          | SRC61          | NT 650 J/K/L (BROS)               | 88-92 | CK1230         | CSK28          | SRC64          |
| TRX 400 FWS/T/V/W/X/Y                | 95-00 | CK1196         | CSK23          | DRC6           | NTV 650 J/K/L/M/P/S/T/V           | 88-97 | CK1230         | CSK33          | SRC62          |
| TRX 400 EX/EY/EXX/EXY/EX1-EX6        | 99-06 | CK1193         | CSK73          | DRC100■        | NT 650 VW/VX/VY/V1-V5 'Deauville' | 98-05 | CK1230         | CSK33          | SRC62          |
| RVF 400 RR/RT/RR-II/RT-II (NC35)     | 94-96 | CK1289         | N/A            |                | NX 650 J/K/L/M/N/P/R/S/T/V/W/X    | 88-02 | CK1170         | CSK16          | DRC54          |
| VF 400 FD                            | 83-85 | CK1165         | CSK9           |                | CB 650 Z/B/SCC                    | 79-82 | CK1147         | CSK84          |                |
| VFR 400 R3K/R3L/R3M/R3N (NC30)       | 89-92 | CK1250         | N/A            | SRC63          | CX 650 ED                         | 83-85 | CK1147         | CSK12          |                |
| VFR 400 ZG/ZH/RG/RG-YA (NC21)        | 85-86 | CK1177         | CSK6           |                | CX 650 TD Turbo                   | 83    | CK1159         | CSK10          |                |
| VFR 400 RH2/RJ (NC24)                | 87-88 | CK1177         | CSK9           |                | GL 650 D2-E                       | 84    | CK1147         | CSK12          |                |
| XR 400 RT                            | 96    | CK1193         | CSK28          | DRC93          | SLR 650 VW                        | 97-98 | CK1170         | CSK16          | DRC54          |
| XR 400 RV/RW/RX/RY/R1-R5             | 97-05 | CK1193         | CSK33          | DRC106         | XL 650 VY/V1/V2/V3/V4/V5/V6/V7    | 00-07 | CK1230         | CSK28          |                |
| XR 400 R5/R6 (NC38E) Motard          | 05-06 | TBA            | TBA            |                | XR 650 RY/R1-R7                   | 00-07 | CK1295         | CSK45          | DRC179         |
| VRX 400 T (NC33)                     | 96    | CK1160         | CSK33          |                | XRV 650 J/K Africa Twin           | 88-89 | CK1230         | CSK28          |                |
| XR 400 R5/R6 Motard (NC38E)          | 05-06 | TBA            | TBA            |                | NT 700 V6/VA7 Deauville           | 06-07 | CK1230         | CSK33          | SRC62          |
| TRX 420 FE7/TE7 Fourtrax Rancher     | 07    | CK1196         | TBA            |                | CB 750/CB 750 K1                  |       |                |                |                |
| TRX 420 FM7/TM7 Fourtrax Rancher     | 07    | CK1154         | TBA            |                | (Up to E.No.:1056079)             | 69-70 | CK1223         | CSK9           |                |
| CB 450 DX-K                          | 89    | CK1140         | CSK47          |                | CB 750 K1 (From E.No.:1056080)    | 70-71 | CK1133         | CSK9           |                |
| CR 450 RB                            | 81    | CK1131         | CSK41          |                | CB 750 K2/K3/K4/K5                | 71-75 | CK1133         | CSK4           |                |
| CRF 450 R2/R3                        | 02-03 | CK1247         | CSK32          | DRC112         | CB 750 KZ                         | 80    | CK1149         | CSK41          |                |
| CRF 450 R4/R5/R6/R7                  | 04-07 | CK1247         | CSK120         | DRC148         | CB 750 F/F1                       | 76-77 | CK1220         | CSK82          |                |
| CRF 450 X5/X6/X7                     | 05-07 | CK1247         | CSK120         | DRC148         | CB 750 K6/K7/F2                   | 76-78 | CK1145         | CSK82          |                |
| CMX 450 CH/CJ Rebel                  | 02    | CK1140         | CSK15          |                | CB 750 FA/FB/F2C                  | 79-82 | CK1149         | CSK41          |                |
| TRX 450 ESW/ESX/ESY/ES1              | 98-01 | CK1196         | CSK23          | DRC6           | CB 750 F2N/F2R/F2S/F2T/F2W        |       |                |                |                |
| TRX 450 R4/R5/R6/ER6/R7/ER7          | 04-07 | CK1302         | CSK32          | DRC131         | /F2X/F2Y/F21                      | 92-02 | CK1265         | CSK6           |                |
| CR 480 RC                            | 82    | CK1131         | CSK24          |                | CBR 750 FH/FJ (Superaero)         | 87-88 | CK1287         | CSK27          |                |
| CR 480 RD                            | 83    | CK1170         | CSK28          | DRC3           | CBX 750 FE                        | 84-85 | CK1166         | N/A            |                |
| CB 500/K1/K2                         | 75-77 | CK1135         | CSK3           |                | VF 750 FD/FE                      | 83-85 | CK1167         | N/A            | SRC2           |
| CB 500 F/K3                          |       | CK1146         | CSK9           |                | VF 750 SC                         | 82    | CK1166         | CSK77          |                |
| CB 500 T                             |       | CK1130         | CSK15          |                | VF 750 CH                         | 87    | CK1166         | CSK77          |                |
| CB 500 R/T/V/W/SW/X/SW/Y/SY/2/S2     | 94-03 | CK1181         | CSK33          |                | VF 750 CP/CR/CS/CT/CV             | 93-97 | CK1206         | CSK28          |                |
| CBF 500 4/A4/A5/A6/A7                | 04-07 | CK1181         | CSK33          |                | VF 750 S 'Sabre'                  | 82-83 | CK1166         | CSK77          |                |

■ EP Kevlar Kit available, see page 310

# EBC CLUTCH KITS

| MAKE & MODEL   | YEAR  | CLUTCH KIT NO. | SPRING KIT NO. | DRC/SRC SERIES | MAKE & MODEL   | YEAR  | CLUTCH KIT NO. | SPRING KIT NO. | DRC/SRC SERIES |
|--|-------|----------------|----------------|----------------|--|-------|----------------|----------------|----------------|
| <b>HONDA Cont.</b>   |       |                |                |                | <b>HONDA-DALL'ARA</b>                                  |       |                |                |                |
| VFR 750 FG/FH/FJ/FL/FM/FN/<br>FP/FR/FS/FT/FV                   | 86-97 | CK1206         | CSK28          | SRC3           | XR 125 SM  | 04    | CK1119         | CSK4           |                |
| VFR 750 RJ/RK/RL (RC30)  | 88-92 | CK1229         | N/A            |                | CR 250 R   | 04    | CK1190         | CSK65          | DRC84          |
| VT 750 C 'Shadow'  | 83    | CK1166         | N/A            |                | XR 250 RM  | 04    | CK1190         | CSK65          | DRC84          |
| VT 750 CV/C2V/CW/C2W/CX/C2X<br>/CY/C2Y/C1/C1Y/C4/C5/C6/C7      | 97-07 | CK1230         | CSK28          |                | XR 400/440 R   | 04    | CK1193         | CSK33          | DRC106         |
| RVF 750 RR-R/RR-S  | 94-98 | CK1257         | N/A            |                | XR 400/440 SM  | 04    | CK1193         | CSK33          | DRC106         |
| XRV 750 L/M/N/P/R/S/T/V/W/X/Y                                  | 90-03 | CK1167         | CSK6           |                | XR 650 R   | 04    | CK1295         | CSK45          |                |
| VT 750 DC1/DC2 'Black Widow'                                   | 01-04 | CK1230         | CSK28          |                | <b>KAWASAKI</b>  |       |                |                |                |
| VT 750 DCA7 Shadow Spirit                                      | 07    | CK1230         | CSK28          |                | AE 50 A1/A2  | 81-84 | CK4442         | CSK18          |                |
| PC 800 Pacific Coast   | 89-97 | CK1167         | TBA            |                | AR 50 A1/C2-C10  | 81-97 | CK4442         | CSK18          |                |
| VFR 800 FI-W/FI-X  | 98-99 | CK1206         | CSK29          |                | KDX 50 A1/A2/A3/A6F                                    | 03-06 | CK3366         | N/A            |                |
| VFR 800 FI-Y/FI-1  | 00-02 | CK1253         | CSK29          |                | KSR I (KMX50 B1/B2)                                    | 90-91 | CK4442         | CSK44          |                |
| VFR 800 2/A2/3/A3/4/A4/5/A5<br>/6/A6/7/A7                      | 02-07 | CK1218         | CSK29          |                | KX 60 A1/A2/B1-B19                                     | 83-03 | CK4438         | CSK18          | DRC7■          |
| CB 900 FZ/FA/FB/F2B/F2C/FD/F2D                                 | 80-83 | CK1149         | CSK84          |                | KX 65 A1/A2/A3/A4/A5/A6/A6F/A7F                        | 00-07 | CK4438         | CSK40          | DRC98          |
| CB 900 F2/F3/F4/F5/F6/F7 Hornet                                | 02-07 | CK1218         | CSK45          | SRC57          | AE 80 A1/B1  | 81-83 | CK4440         | CSK18          |                |
| CBR 900 RRP/RRN/RRR/RRS  | 92-95 | CK1206         | CSK28          | SRC3           | AR 80 A1/C1-C8   | 81-91 | CK4440         | CSK18          |                |
| CBR 900 RRT/RRV  | 96-97 | CK1284         | CSK45          | SRC55          | KSR II (KMX 80 B1/B2)                                  | 90-91 | CK4440         | CSK44          |                |
| CBR 900 RRW/RRX  | 98-99 | CK1218         | CSK45          | SRC57          | KX 80 E1/E2  | 83-84 | CK4438         | CSK40          |                |
| CBR 900 RRY/RR1<br>(929cc Fireblade)                           | 00-01 | CK1206         | CSK45          | SRC19          | KX 80 E3/G1/G2/J1/J2                                   | 85-87 | CK4468         | CSK34          | DRC8           |
| CBR 900 RR2/RR3 (954cc) Fireblade                              | 02-03 | CK1206         | CSK45          | SRC19          | KX 80 L1   | 88    | CK4477         | CSK35          | DRC9           |
| CBR 1000 FH/FJ/FK/FL/FM/FN<br>FP/FR/FS/FT/FV/FW/FX             | 87-99 | CK1248         | CSK29          | SRC4           | KX 80 L2/L3/R1-R7                                      | 89-97 | CK4478         | CSK35          | DRC10■         |
| CB 1000 FP/FR/FS/FT/FV   | 93-97 | CK1248         | CSK29          | SRC4           | KX 80 W1/W2/W3   | 98-00 | CK4453         | CSK41          | DRC45          |
| CBR 1000 RR4/RR5/RR6/RR7<br>Fireblade                          | 04-07 | CK1303         | CSK112         | SRC80          | KX 85/85 II A1-A5/A6F/A7F/B1-B5/B6F/B7F                | 01-07 | CK4453         | CSK41          | DRC45          |
| CBF 1000 FA6/FA7 (ABS Model)                                   | 06-07 | CK1303         | CSK90          |                | KC 100 C1-C4   | 81-83 | CK4440         | CSK19          |                |
| CBF 1000 F6/F7   | 06-07 | CK1303         | CSK90          |                | KE 100 A8-A10  | 79-81 | CK4440         | CSK19          |                |
| CBX 1000 Z   | 79    | CK1183         | CSK84          |                | KE 100 B1-B15  | 82-98 | CK4440         | CSK40          |                |
| CBX 1000 B/C   | 80-81 | CK1183         | CSK10          |                | KH 100 A2-A4/G2-G8                                     | 78-87 | CK4440         | CSK19          |                |
| GL 1000 K1 (Up to E.No.:2002383)                               | 77    | CK1221         | CSK10          |                | KM 100 A4/A6   | 79-80 | CK4440         | CSK19          |                |
| GL 1000 K1/K2 (From E.No.:2002384)                             | 77-78 | CK1143         | CSK10          |                | KX 100 N1  | 88    | CK4477         | CSK35          | DRC9           |
| VF 1000 FE/FF/RE/RF/RG/F2F                                     | 84-86 | CK1176         | N/A            |                | KX 100 A1/A2/B1-B7                                     | 89-97 | CK4478         | CSK35          | DRC10■         |
| VTR 1000 FV/FW/FX/FY/F1-F6<br>'Firestorm'                      | 97-06 | CK1290         | CSK66          | SRC60          | KX 100 C1/C2/C3  | 98-00 | CK4453         | CSK41          | DRC45          |
| VTR 1000 SPY/SP1 (SC45)  | 00-01 | CK1291         | CSK43          |                | KLF 110 B1/B2  | 87-88 | CK4463         | N/A            |                |
| VTR 1000 SP-2/SP-3/SP-4/SP-5/SP-6                              | 02-07 | CK1300         | CSK43          |                | KLX 110 R (KLX 110 A1-A4/A6F)                          | 02-06 | CK4438         | CSK40          |                |
| XL 1000 VY/VX/V1-V5  | 99-05 | CK1290         | CSK66          |                | AR 125 A1A/A1-A7/B1-B8                                 | 83-94 | CK4453         | CSK41          |                |
| XL 1000 V3/V4/VA5/V5/VA5/V6<br>/VA6/VA7 Varadero               | 03-07 | CK1257         | N/A            |                | BN 125 A1-A5/A6F/A7F Eliminator                        | 98-07 | CK4511         | CSK41          |                |
| CB 1100 RB2/RC2  | 80-81 | CK1149         | CSK9           |                | KE 125 A7-A12  | 80-85 | CK4411         | CSK1           |                |
| CB 1100 RD2  | 82    | CK1149         | CSK46          |                | KDX 125 A1/A2/B1/B2                                    | 90-94 | CK4489         | CSK1           |                |
| CB 1100 SFY/SF1 "X11"  | 00-03 | CK1291         | CSK43          |                | KH 125 A1-A4   | 77-81 | CK4411         | CSK1           |                |
| CBR 1100 XXV/XXW 'Blackbird'                                   | 97-98 | CK1286         | CSK70          |                | KH 125 K1  | 82    | CK4440         | CSK40          |                |
| CBR 1100 XXX/XXY/XX1-XX7 'Blackbird'                           | 99-07 | CK1291         | CSK43          |                | KH 125 K2-K10  | 82-98 | CK4438         | CSK40          |                |
| GL 1100 A/DA/B/IB/DB (SC02)                                    | 80-81 | CK1159         | CSK10          |                | KH 125-L1 (KH125EX)                                    | 83    | CK4438         | CSK40          |                |
| ST 1100 L/M/N/P/R/S/T/V/W/X/Y/1<br>/AN/AR/AS/AT/AV/AW/AX/AY/A1 | 90-01 | CK1264         | CSK33          |                | KLX 125 A1/A2/A3/A6F                                   | 03-06 | CK3318         | CSK34          |                |
| VT 1100 CH/CJ/CN/CP Shadow                                     | 87-93 | CK1239         | N/A            |                | KLX 125 L (B1/B2/B3/B6F)                               | 03-06 | CK3318         | CSK34          |                |
| VT 1100 CR/CS/CT/CV/CW Shadow                                  | 94-98 | CK1239         | N/A            |                | KMX 125 A1/A2  | 86-87 | CK4453         | CSK31          |                |
| VT 1100 C3 Shadow  |       | CK1176         | TBA            |                | KMX 125 A3/A4/A5                                       | 88-89 | CK4486         | CSK31          |                |
| VT 1100 C4 Shadow Sabre  | 04-05 | CK1176         | N/A            |                | KMX 125 B1/B2 (From E/No.-<br>MX 125 AE 000001-013436) | 86-87 | CK4453         | CSK31          |                |
| GL 1200 AE/DE/AF   | 84-85 | CK1210         | N/A            |                | (From E/No. MX AE 013437)                              | 87-03 | CK4486         | CSK31          |                |
| GL 1200 DH/AH/AG/DG  | 86-87 | CK1224         | N/A            |                | KX 125 B1  | 82    | CK4436         | CSK1           |                |
| CB 1300 FW/FX/FY/F1 (SC40)                                     | 98-01 | CK1299         | TBA            |                | KX 125 B2  | 83    | CK4457         | CSK36          |                |
| CB 1300 DCV/DCW/DCX<br>/DCY (SC38)                             | 97-00 | CK1290         | CSK70          |                | KX 125 C1  | 84    | CK4457         | CSK1           |                |
| CB 1300 F3/F13   | 03-04 | CK1257         | CSK113         |                | KX 125 D1/E1/E2  | 85-87 | CK4469         | CSK1           | DRC11          |
| CB 1300 5/6 (Superfour)  | 05-06 | CK1257         | CSK113         |                | KX 125 F1/G1   | 88-89 | CK4482         | CSK6           | DRC13          |
| CB 1300 A5/A6/A7 (Superfour ABS)                               | 05-07 | CK1257         | CSK113         |                | KX 125 H1/H2   | 90-91 | CK4485         | CSK116         | DRC36■         |
| CB 1300 SA5/SA6/SA7 Super Bol-Dor                              | 05-07 | CK1257         | CSK113         |                | KX 125 J1  | 92    | CK4485         | CSK116         | DRC83          |
| ST 1300 A2/2/3/A3/4/A4/5/A5/A6/A7<br>Pan European              | 02-07 | CK1297         | CSK96          |                | KX 125 J2  | 93    | CK4498         | CSK116         | DRC69■         |
| VTX 1300 S3/S4/S5/S6/S7  | 03-07 | CK1298         | CSK90          |                | KX 125 K1/K2/K3/K4/K5/L1-L4                            | 94-02 | CK4425         | CSK65          | DRC73■         |
| GL 1500 J/K/L/SEM/SEN/SEP<br>SER/SES/SEX 'Goldwing'            | 88-96 | CK1285         | N/A            |                | KX 125 M1/M2/M3/M6F/M7F                                | 03-07 | CK4425         | CSK97          | DRC122■        |
| GL 1500 CV/CW/CX/CY/C1/C2 'F6C'                                | 97-03 | CK1285         | N/A            |                | KDX 175 A1-A3  | 80-82 | CK4436         | CSK1           |                |
| GL 1500 SEV/SEW/SEX/SEY<br>Goldwing                            | 97-00 | CK1285         | N/A            |                | KE 175 D1-D5   | 79-83 | CK4411         | CSK39          |                |
| GL 1800 A1-A7 "Goldwing"                                       | 01-07 | CK1297         | N/A            |                | KDX 185 A3   | 87    | CK1119         | CSK3           |                |
| VTX 1800 C2/C3/C4/C15  | 02-05 | CK1298         | CSK90          |                | KDX 200 A1/A2  | 83-84 | CK4457         | CSK36          |                |
|  |       |                |                |                | KDX 200 A3   | 85    | CK4457         | CSK1           |                |
|  |       |                |                |                | KDX 200 C1/C2  | 86-87 | CK4469         | CSK1           | DRC74          |
|  |       |                |                |                | KDX 200 C3   | 88    | CK4469         | CSK1           | DRC11          |
|  |       |                |                |                | KDX 200 E1/E2/E3/E4/E5/E6                              | 89-94 | CK4482         | CSK10          | DRC61          |
|  |       |                |                |                | KDX 200 H1/H2/H3/H4/H5                                 | 95-99 | CK4505         | CSK30          | DRC62          |
|  |       |                |                |                | KMX 200 A2/A3  | 88-92 | CK4486         | CSK9           |                |
|  |       |                |                |                | Z 200 A1 (Up to E.No.:005062)                          | 77    | CK4446         | CSK7           |                |
|  |       |                |                |                | Z 200 A1 (From E.No.:005063)                           | 78    | CK4425         | CSK7           |                |
|  |       |                |                |                | Z 200 A2-A6  | 79-83 | CK4425         | CSK7           |                |
|  |       |                |                |                | KDX 220 R A4-A12/A6F                                   | 97-06 | CK4505         | CSK30          | DRC62          |

CLUTCH APPLICATIONS

# EBC CLUTCH KITS

| MAKE & MODEL                    | YEAR        | CLUTCH KIT NO. | SPRING KIT NO. | DRC/SRC SERIES | MAKE & MODEL                       | YEAR  | CLUTCH KIT NO. | SPRING KIT NO. | DRC/SRC SERIES |
|---------------------------------|-------------|----------------|----------------|----------------|------------------------------------|-------|----------------|----------------|----------------|
| <b>KAWASAKI Cont..</b>          |             |                |                |                | <b>KAWASAKI Cont..</b>             |       |                |                |                |
| KDX 220 SR                      |             | CK4505         | CSK30          | DRC62          | ZL 400 A 'Eliminator'              | 86-87 | CK4424         | CSK7           | SRC22          |
| KLF 220 A1-A15                  | 88-02       | CK1180         | N/A            |                | ZL 400 B 'Eliminator 400 SE'       | 88    | CK4424         | CSK7           | SRC22          |
| BJ 250 B1-B7A 'Estrella'        | 92-99       | CK4508         | CSK4           |                | ZR 400 A1/B1 (Z 400 F)             | 83-84 | CK4424         | CSK10          | SRC11          |
| BJ 250 E1-EA Estrella-RS Custom | 96-99       | CK4508         | CSK4           |                | ZRX 400 (ZR 400 E1-E7)             | 94-01 | CK4424         | TBA            |                |
| BJ 250 C1-C7 Estrella-RS        | 95-01       | CK4508         | CSK4           |                | ZR 400 Zephyr (G2/G3/G3A/G4/G5)    | 97-01 | CK4424         | CSK23          | SRC44          |
| BJ 250 D1-D7 Estrella Custom    | 96-02       | CK4508         | CSK4           |                | ZX 400 C2 (Z 400 F 11)             | 85    | CK4424         | CSK10          | SRC10          |
| BJ 250 F1/F2 (250 TR)           | 02-03       | CK4508         | CSK7           |                | ZXR 400 H1/H2                      | 89    | CK4446         | CSK7           |                |
| EL 250 D1-D5                    | 90-94       | CK4473         | CSK4           |                | ZXR 400 (ZX 400 L1-L5/L8/L9)       | 91-02 | CK4446         | CSK6           | SRC21          |
| EL 250 B1/B2/B3 'Eliminator'    | 87-89       | CK4473         | CSK4           |                | ZXR 400 R (ZX 400 M1-M4)           | 91-94 | CK4446         | CSK6           |                |
| ER 250 B1/B2/B3 Scorpion        | 83-88       | CK4433         | CSK7           |                | ZX 400 J1/J2                       | 89-90 | CK4446         | CSK7           |                |
| GPX 250 R (ZX 250 F2/F3/F6-F9)  | 88-95       | CK4473         | CSK4           |                | Xanthus (ZR 400 D1/D3/D4)          | 92-95 | CK4446         | CSK7           |                |
| GPZ 250 R (EX 250 E)            | 86          | CK4473         | CSK4           |                | Z 440 A2/C1/C2                     | 80-81 | CK4421         | CSK7           |                |
| GPX 250 R II (EX 250 G)         | 88          | CK4473         | CSK4           |                | Z 440 D4-D6 (Ltd)                  | 82-84 | CK4421         | CSK7           |                |
| KLF 250 A1/A2 (Bayou 250)       | 03-04       | CK1180         | TBA            |                | Z 440 H1/H2                        | 82-83 | CK4421         | CSK7           |                |
| KLT 250 C1-C3                   | 83-85       | CK4425         | CSK7           |                | ZZR 400 (ZX 400 K1/K2/K3)          | 90-92 | CK4424         | CSK7           |                |
| KXT 250 A1 Tecate               | 84          | CK4433         | CSK7           |                | ZZR 400 (ZX 400 N1-N7)             | 93-99 | CK4424         | CSK43          |                |
| KXF 250 A1/A2                   | 87-88       | CK4475         | CSK7           |                | KX 420 A1/A2                       | 80-81 | CK4439         | CSK6           |                |
| KSF 250 A8/A9/A15               | 94-95/01-02 | CK4425         | CSK7           |                | EN 450 A1-A5 (Ltd 450)             | 86-89 | CK4424         | CSK23          | SRC44          |
| KL 250 A1-A4/C1/C2              | 78-84       | CK4425         | CSK7           |                | KX 450 F (D6F/D7F)                 | 06-07 | CK1247         | CSK121         | DRC158         |
| KL 250 H1 'Super Sherpa'        | 98          | CK4469         | CSK74          |                | KFX 450 R Quad                     | 07    | TBA            | TBA            |                |
| KL 250 J1 Stockman              |             | CK4469         | CSK74          |                | KLX 450 R (A8F)                    | 07    | TBA            | TBA            |                |
| KLE 250 A1/A1A/A2 (Anhelio)     |             | CK4473         | CSK7           |                | EN 500 A1/A2/A3/A4/B1/B2/C1-C9     | 90-04 | CK4424         | CSK23          | SRC44          |
| KLE 250 A2                      | 95          | TBA            | TBA            |                | ER-5 (ER 500 A1/A2/A3/A4/C1-C5P)   | 97-07 | CK4424         | CSK23          | SRC44          |
| KLE 250 A3                      | 97          | TBA            | TBA            |                | EX 500 A1-A6/D1-D7 (Gpz 500 S)     | 87-02 | CK4424         | CSK23          | SRC44          |
| KLE 250 A5/A6                   | 00-01       | TBA            | TBA            |                | GPZ 500 (S) (EX 500 B1-B5)         | 88-93 | CK4424         | CSK23          | SRC44          |
| KLR 250 D2-D22                  | 84-05       | CK4446         | CSK7           | DRC63          | GPZ 500 S (EX 500 E1-E10)          | 94-04 | CK4424         | CSK23          | SRC44          |
| KLX 250 J1-J6 D-Tracker         | 98-03       | CK4469         | CSK1           |                | KH 500 A8                          | 76    | CK4425         | CSK7           |                |
| KX 250 B1/C1                    | 82-83       | CK4465         | CSK6           |                | KX 500 A1/A2                       | 83-84 | CK4433         | CSK7           |                |
| KX 250 C2                       | 84          | CK4465         | CSK7           |                | KX 500 B1/B2                       | 85-86 | CK4459         | CSK7           |                |
| KX 250 D1                       | 85          | CK4459         | CSK7           |                | KX 500 C1/D1                       | 87-88 | CK4475         | CSK10          | DRC16          |
| KX 250 D2                       | 86          | CK4459         | CSK10          |                | KX 500 E1-E16                      | 89-04 | CK4475         | CSK7           | DRC15          |
| KX 250 E1/F1/G1                 | 87-89       | CK4475         | CSK7           | DRC15          | KLE 500 A1-A12                     | 91-04 | CK4424         | CSK23          | DRC64          |
| KX 250 H1                       | 90          | CK4475         | CSK6           | DRC17          | KLE 500 B1P/B6F/B7F                | 05-07 | CK4424         | CSK23          | DRC64          |
| KX 250 H2                       | 91          | CK4475         | CSK30          | DRC41          | Z 500 A1-A3/B1/B2                  | 79-81 | CK4424         | CSK10          | SRC11          |
| KX 250 J1/J2/K1-K5/L1-L4        | 92-02       | CK4435         | CSK7           | DRC46          | GT 550 G1-G9                       | 83-01 | CK4424         | CSK10          | SRC11          |
| KX 250 M1/M2/R1/R6F/R7F         | 03-07       | CK4435         | CSK7           | DRC46          | GPz 550 D1/H1/H2/A1-A4             | 81-87 | CK4424         | CSK10          | SRC11          |
| KX 250 F (KX 250 N1/N2/T6F/T7F) | 04-07       | CK4514         | CSK97          | DRC123         | ZR 550 A1/A2 (Z 550 F)             | 83-84 | CK4424         | CSK10          | SRC11          |
| KDX 250 B1                      | 81          | CK4439         | CSK6           |                | ZR 550 B2-B6 "Zephyr"              | 91-99 | CK4424         | CSK10          | SRC11          |
| KDX 250 B2/B3                   | 82-83       | CK4433         | CSK6           |                | Z 550 C1/C2 (Ltd)                  | 80-81 | CK4424         | CSK10          | SRC11          |
| KDX 250 D1                      | 91-93       | CK4475         | CSK30          | DRC41          | KL 600 A1 (KLR 600)                | 84    | CK4424         | CSK10          | SRC11          |
| KDX 250 SR (KDX 250 F1)         | 91          | CK4509         | CSK30          |                | KLR 600 B1/B2/B4/B6-B9             | 85-94 | CK4424         | CSK23          | SRC44          |
| KLX 250 D1/D2                   | 93-95       | CK4469         | CSK1           |                | GPz 600 R A1-A6                    | 85-89 | CK4424         | CSK10          | SRC11          |
| KLX 250 F1-F4 (KLX 250 E)       | 94-97       | CK4469         | CSK1           |                | GPX 600 R (C1-C3/C6-C7)            | 88-96 | CK4424         | CSK10          | SRC11          |
| KLX 250 G1                      | 94-         | CK4469         | CSK1           |                | ZL 600 B1                          | 95-97 | CK4424         | CSK23          | SRC44          |
| KLX 250 H6                      | 04          | TBA            | TBA            |                | ZZ-R 600 D1/D2/D2A/D3              | 90-92 | CK4424         | CSK7           | SRC22          |
| KR-1 (KR 250 B2)                | 89          | CK4484         | CSK10          |                | ZZR 600 (ZX 600 E1-E13)            | 93-05 | CK4424         | CSK43          | SRC43          |
| KR-1S (KR 250 C2/C3)            | 90-92       | CK4484         | CSK10          |                | ZZR 600 (ZX 600 E6F)               | 06-07 | CK4424         | CSK43          | SRC43          |
| KR 250 A1/A2                    | 84-86       | CK4517         | CSK10          |                | ZX-6R F1/F2/F3                     | 95-97 | CK4503         | CSK56          | SRC38          |
| KH 250 B4/B5                    | 79-80       | CK4436         | CSK1           |                | ZX-6R (ZX 600 G1/G2/J1/J2)         | 98-01 | CK4503         | CSK56          | SRC38          |
| Z 250 A1-A3/B1/B2               | 79-81       | CK4433         | CSK6           |                | ZX6R (ZX636A1P) 636cc              | 02    | CK4503         | CSK56          | SRC38          |
| Z 250 C1/C2/G1/G2               | 80-83       | CK4425         | CSK7           |                | ZX6R (ZX 636 B1/B2)                | 03-04 | CK4503         | CSK56          | SRC38          |
| ZR 250 A1-A5 Balius             | 91-95       | CK4508         | CSK7           |                | ZX-6R (ZX 600 P7F)                 | 07    | CK4514         | CSK117         | SRC84          |
| ZR 250 B6 (Balius-II)           | 02          | CK4508         | CSK7           |                | ZX-6R (ZX 636 C1/C6F)              | 05-06 | CK4514         | CSK117         | SRC84          |
| ZZ-R 250 (EX 250 H1-H13)        | 90-03       | CK4473         | CSK4           |                | ZX6RR (ZX 600 K1)                  | 03    | CK4503         | CSK99          | SRC76          |
| ZXR 250 (ZX 250 A1/A2)          | 89-90       | CK4508         | CSK7           |                | ZX6RR (ZX 600 M1)                  | 04    | CK4514         | CSK99          | SRC83          |
| ZXR 250 C1-C5 (ZX 250 C1-C5)    | 91-95       | CK4508         | CSK7           |                | ZX-6RR (ZX 600 N1/N6F)             | 05-06 | CK4514         | CSK117         | SRC84          |
| ZXR 250 R (ZX 250 D1)           | 91          | CK4508         | CSK7           |                | ER-6F (EX 650 A6F/A7F)             | 06-07 | CK4424         | CSK7           | SRC22          |
| ZXR 250 R (ZX 250 B1/B2)        | 89-90       | CK4509         | CSK7           |                | ER-6F (ABS Model) (EX 650 B6F/B7F) | 06-07 | CK4424         | CSK7           | SRC22          |
| EL 252 (EL 250 F2/F3)           | 97-03       | CK4473         | CSK4           |                | ER-6N (ER 650 A6F/A7F)             | 06-07 | CK4424         | CSK7           | SRC22          |
| KEF 300 B1/B2 Lakota Sport      | 01-02       | CK4419         | N/A            |                | ER6N (ABS) ER 650 B6F/B7F          | 06-07 | CK4424         | CSK7           | SRC22          |
| KLX 300 A2-A10/A6F              | 97-06       | CK4469         | CSK1           |                | KLE 650 A7F Versys                 | 07    | CK4424         | CSK7           | SRC22          |
| KLF 300 A1/A2/B1-B17/C1-C17     | 87-05       | CK4419         | CSK4           |                | KLE 650 B7F Versys ABS             | 07    | CK4424         | CSK7           | SRC22          |
| GPz 305 A1/B2-B10               | 83-96       | CK4433         | CSK7           |                | KLR 650 A1-A3                      | 87-89 | CK4424         | CSK7           | DRC65          |
| KH 400 A3-A5                    | 76-78       | CK4457         | CSK1           |                | KL 650 B1/B2/B3 Tengai             | 89-92 | CK4424         | CSK7           | DRC65          |
| KLF 400 B1-B7                   | 93-98       | CK4439         | N/A            |                | KLX 650 C1/C2/C3                   | 93-97 | CK4424         | CSK7           | DRC65          |
| KLX 400 R (KLX 400 B1/B2)       | 03-04       | CK3433         | CSK79          | DRC105         | KLR 650 C1-C10                     | 95-04 | CK4435         | CSK30          |                |
| KSF 400 A1/A2 (KFX 400)         | 03-04       | CK3433         | CSK79          | DRC105         | W 650 (EJ 650 A1/C3-C7)            | 99-05 | CK4435         | CSK23          |                |
| KSF 400 A3/A6F (KFX 400)        | 05-06       | CK3447         | CSK79          | DRC137         | Z 650 B1-B3/C1-C3                  | 77-81 | CK4413         | CSK7           |                |
| FX 400 R (ZX 400 E1/E2/E3)      | 86-88       | CK4424         | CSK23          |                | Z 650 D2/D3/F1-F4                  | 79-83 | CK4413         | CSK7           |                |
| GPZ 400 R (ZX 400 D1/D2/D3/D3A) | 85-87       | CK4424         | CSK23          |                | Z 700 A1 'Ltd'                     | 84    | CK4413         | CSK7           |                |
| GPZ 400 R (ZX 400 F1)           | 87          | CK4424         | CSK23          |                | ZN 700 A1/A2 'Ltd'                 | 84-85 | CK4413         | CSK7           |                |
| Z 400 B1/B2/G1                  | 78-80       | CK4421         | CSK7           |                | VN 700 A1 'Vulcan'                 | 85    | CK4435         | CSK7           | SRC53          |
| Z 400 J1-J3                     | 80-83       | CK4424         | CSK10          | SRC11          | GPX 750 F1/F2/F2A/F3               | 87-89 | CK4435         | CSK7           | SRC53          |

■ EP Kevlar Kit available, see page 310

# EBC CLUTCH KITS

| MAKE & MODEL                         | YEAR  | CLUTCH KIT NO. | SPRING KIT NO. | DRC/SRC SERIES | MAKE & MODEL                      | YEAR  | CLUTCH KIT NO. | SPRING KIT NO. | DRC/SRC SERIES |
|--------------------------------------|-------|----------------|----------------|----------------|-----------------------------------|-------|----------------|----------------|----------------|
| <b>KAWASAKI Cont..</b>               |       |                |                |                | <b>KAWASAKI Cont..</b>            |       |                |                |                |
| GPz 750 R1                           | 82    | CK4413         | CSK7           |                | VN 1500 B2-B6                     | 88-92 | CK4455         | N/A            |                |
| GPz 750 A1-A5                        | 83-87 | CK4413         | CSK7           |                | VN 1500 C1/C2                     | 94-95 | CK4455         | N/A            |                |
| GPz 750 R G2/G3                      | 85-86 | CK4435         | CSK10          | SRC24          | VN 1500 D1/D2                     | 96-98 | CK4455         | N/A            |                |
| GT 750 P1-P5                         | 82-90 | CK4413         | CSK7           |                | VN 1500 G1/G2                     | 98-99 | CK4455         | N/A            |                |
| Z 750 D1                             | 76    | CK4435         | CSK7           | SRC53          | VN 1500 E1/E2 'Classic'           | 98-99 | CK4455         | N/A            |                |
| Z 750 B1/B2                          | 77-78 | CK4435         | CSK7           | SRC53          | VN 1500 J1/J2/R1/R2/R3 Drifter    | 99-04 | CK4455         | N/A            |                |
| Z 750 N1/N2 'Spectre'                | 82-83 | CK4413         | CSK7           |                | VN 1500 N1/N2/N3 "Classic Fi"     | 00-04 | CK4455         | N/A            |                |
| Z 750 (ZR 750 J1/J2/J6F)             | 04-06 | CK4503         | CSK56          | SRC38          | VN 1500 L1/L2/L3/L4 "Nomad Fi"    | 00-03 | CK4455         | N/A            |                |
| GT 750 P7/P9                         | 92-96 | CK4493         | CSK23          |                | VN 1500 P1/P2 Mean Streak         | 02-04 | CK4455         | N/A            |                |
| VN 750 A2/A3/A4/A5/A10               | 86-94 | CK4435         | CSK7           | SRC53          | VN 1600 A1/A2/A3/A6F Classic      | 03-07 | CK4455         | N/A            |                |
| ZX 750 E1/E2 (Turbo)                 | 84-87 | CK4443         | CSK7           |                | VN 1600 B1 Mean Streak            | 04    | CK4455         | N/A            |                |
| ZXR 750 H1/H2                        | 89-90 | CK4424         | CSK23          | SRC44          | VN 1600 B2H/B6F/B7F (Mean Streak) | 05-07 | CK4455         | N/A            |                |
| ZR 750 C1/C2/C3/C4 'Zephyr'          | 92-95 | CK4493         | CSK10          |                | VN 1600 D1H/D6F Classic Tourer    | 05-07 | CK4455         | N/A            |                |
| ZR 750 C5/D1 'Zephyr'                | 95-98 | CK4493         | CSK38          |                | VN 2000 A1/A2/A6F/F7F             | 04-07 | CK4516         | CSK110         |                |
| ZR7 (ZR 750 F1/F3/F5)                | 99-04 | CK4493         | CSK38          |                |                                   |       |                |                |                |
| ZR-7S (ZR 750 H1/H2)                 | 01-04 | CK4493         | CSK38          |                | <b>SUZUKI</b>                     |       |                |                |                |
| ZXR 750 J1/J2/L1-L3/P1-P7            | 91-03 | CK4435         | CSK88          | SRC24          | AP 50                             | -78   | CK3311         | CSK25          |                |
| ZXR 750 R (ZX 750 K1/K2/M1/M2)       | 91-94 | CK4435         | CSK88          | SRC24          | FR 50                             | 81-   | CK3393         | N/A            |                |
| ZX7 RR (ZX 750 N1/N2)                | 96-99 | CK4435         | CSK38          | SRC41          | GS 50 K5 (NA41A)                  | 05    | CK3328         | CSK13          |                |
| Z 750 E1/H1/H2/L1-L4                 | 80-84 | CK4413         | CSK7           |                | GT 50 KB/KEN                      | 77-80 | CK3328         | CSK1           |                |
| Z 750 Y1 (Ltd)                       | 82    | CK4435         | CSK7           | SRC53          | JR 50 (All models)                | 78-07 | CK3366         | CSK2           |                |
| Z 750 S (ZR 750 K1/K6)               | 05-07 | CK4503         | CSK56          | SRC38          | RM 50 C/N/T/X/Z                   | 78-82 | CK3328         | CSK1           |                |
| Z 750 (ZR 750 L7F)                   | 07    | TBA            | TBA            |                | OR 50 ET                          | 80    | CK3328         | CSK1           |                |
| Z 750 ABS (ZR 750 M7F)               | 07    | TBA            | TBA            |                | RB 50 H                           | 87    | CK3380         | CSK1           |                |
| VN 800 A1-A3/B1-B10/B6F              | 95-06 | CK4435         | CSK23          | SRC46          | RG 50 EW                          |       | CK3349         | CSK1           |                |
| VN 800 C1/C2/E1/E2/E3 'Drifter'      | 99-04 | CK4435         | CSK7           | SRC53          | TS 50 KN/ERKT/ERKX/ERKZ/          |       |                |                |                |
| Z1/Z1 A/Z1 B                         | 74-76 | CK4409         | CSK7           |                | ERKD                              | 79-83 | CK3328         | CSK1           |                |
| ZL 900 A1/A2 'Eliminator'            | 85-86 | CK4434         | CSK7           | SRC52          | TS 50 XKE/XKG/XKH/XKJ/            |       |                |                |                |
| Z 900 A4/A5                          | 76-77 | CK4409         | CSK7           |                | XKM/XKR                           | 84-02 | CK3349         | CSK1           |                |
| GPz 900 R A1-A8                      | 84-96 | CK4435         | CSK7           | SRC53          | TS 50 W                           |       | CK3349         | CSK1           |                |
| GPZ 900 R (ZX 900 A11)               | 98    | CK4435         | CSK7           | SRC53          | ZR 50 KEN/KEX                     | 79-81 | CK3328         | CSK1           |                |
| GPZ 900 R (ZX 900 A12-15)            | 99-02 | CK4435         | CSK7           | SRC53          | ZR 50 SLKX/SKX                    | 81    | CK3328         | CSK1           |                |
| VN 900 A6F Classic                   | 06    | CK4435         | CSK7           | SRC53          | ZR 50 SKE/SKH                     | 84-87 | CK3328         | CSK1           |                |
| VN 900 C7F Custom (Cast wheel)       | 07    | CK4435         | CSK7           | SRC53          | RM 60 K3                          | 03    | CK4438         | CSK18          | DRC7■          |
| VN 900 B7F Classic (Spoke wheel)     | 07    | CK4435         | CSK7           | SRC53          | RM 65 K3/K4/K5                    | 03-05 | CK4438         | CSK40          | DRC98          |
| ZX-9R (ZX 900 B1-B4)                 | 94-97 | CK4435         | CSK38          | SRC41          | DS 80 T/X/Z/D/F/G/H/J/K/L/M/N/    |       |                |                |                |
| ZX9R (ZX 900 C1/C2/E1/E2/F1/F2)      | 98-04 | CK4510         | CSK67          | SRC59          | P/R/S/T/V/W/X/Y                   | 80-00 | CK3340         |                |                |
| KLX 1000 (LV 1000 A1H/A2H)           | 04-05 | CK3443         | CSK43          |                | FR 80 M/B/N/X/Z/D                 | 76-83 | CK3378         | N/A            |                |
| Z 1000 D1-D3 'Z1R'                   | 78-80 | CK4409         | CSK7           |                | JR 80 K1/K2/K3/K4/K5/K6/K7        | 01-07 | CK3340         | CSK1           |                |
| Z 1000 E1/E2 (ST-Shaft)              | 79-80 | CK4434         | CSK23          | SRC20          | RM 80 M                           | 81    | CK3318         | CSK14          |                |
| Z 1000 A1-A4/H1/H2                   | 77-81 | CK4409         | CSK7           |                | RM 80 C/XT/XX                     | 78-81 | CK3318         | CSK1           |                |
| Z 1000 K1 (Ltd)/J1-J3                | 81-83 | CK4434         | CSK7           | SRC52          | RM 80 XZ                          | -82   | CK3340         | CSK36          |                |
| Z 1000 R2                            | 83    | CK4434         | CSK7           | SRC52          | RM 80 XD/HD                       | 83    | CK3340         | CSK34          |                |
| Z 1000 (ZR 1000 A1/A2/A3/A6F)        | 03-06 | CK4510         | CSK67          | SRC59          | RM 80 XE/XF/HF                    | 84-85 | CK3318         | CSK34          |                |
| GPz 1000 RX A1-A3                    | 86-88 | CK4434         | CSK23          | SRC20          | RM 80 XG                          | 86    | CK3367         | CSK34          |                |
| 1000 GTR (ZG 1000 A1-A18)            | 86-03 | CK4434         | CSK23          | SRC20          | RM 80 XH/XJ                       | 87-88 | CK3367         | CSK55          | DRC19          |
| Z 1000 (ZR 1000 B7F)                 | 07    | CK4510         | CSK67          | SRC59          | RM 80 K/L                         | 89-90 | CK3318         | CSK1           | DRC20          |
| Z 1000 ABS (ZR 1000 C7F)             | 07    | CK4510         | CSK67          | SRC59          | RM 80 M/N/P/R/S/T/V/W/X/Y/K1      | 91-01 | CK3318         | CSK14          | DRC25■         |
| ZX 10 B1/B2/B3                       | 88-90 | CK4434         | CSK23          | SRC20          | RM 85 K2/LK2/K3/LK3/K4/LK4        | 02-04 | CK3318         | CSK14          | DRC25■         |
| ZX 10R (ZX 1000 C1/C2/D6F/D7F)       | 04-07 | CK4510         | CSK111         | SRC79          | RM 85 K5/LK5/K6/LK6/K7/LK7        | 05-07 | CK3318         | CSK14          | DRC25■         |
| ZL 1000 A1                           | 87    | CK4434         | CSK23          | SRC20          | FB 90 K1                          | 01    | N/A            | N/A            |                |
| GPz 1100 B1/B2                       | 81-82 | CK4434         | CSK7           | SRC52          | A 100 L/M/N                       | 74-80 | CK3312         | CSK25          |                |
| GPz 1100 A1-A3                       | 82-85 | CK4434         | CSK23          | SRC20          | GP 100 C/UC                       | 78    | CK3319         | CSK25          |                |
| Z 1100 R1                            | 84    | CK4434         | CSK23          | SRC20          | GP 100 N/UN                       | 79    | CK3318         | CSK25          |                |
| Z 1100 A1-A3                         | 81-83 | CK4434         | CSK7           | SRC52          | GP 100 X/UX/D/UD/UL               | 81-92 | CK3339         | CSK25          |                |
| Z 1100 D1/D2 'Spectre'               | 82-83 | CK4434         | CSK7           | SRC52          | RM 100 A                          | 76    | CK3319         | CSK25          |                |
| ZR 1100 A1/A2/A3/A4/B1               | 92-97 | CK4434         | CSK23          | SRC20          | RM 100 B/C                        | 77-78 | CK3329         | CSK25          |                |
| ZR 1100 B5 (Zephyr 1100 RS)          | 02    | CK4434         | CSK23          |                | RM 100 N/T/X                      | 79-81 | CK3319         | CSK25          |                |
| ZRX 1100 (ZX 1100 C1/C2/C3/C4)       | 97-00 | CK4434         | CSK23          | SRC20          | RM 100 K3                         | 03    | CK4453         | CSK41          | DRC45          |
| ZZ-R 1100 C1/C2/C2A/C3/D1-D9         | 90-01 | CK4488         | CSK29          | SRC25          | TS 100 K/L/M/A/B                  | 73-77 | CK3326         | CSK25          |                |
| ZX 1100 E1/E2/F1                     | 95-98 | CK4488         | CSK29          | SRC25          | TS 100 C                          | 78    | CK3318         | CSK25          |                |
| ZRX 1200 R A1/A2/A3/A4/A5/A6F        | 01-07 | CK4434         | CSK38          |                | TS 100 ERN Upto F 300563          | 79    | CK3318         | CSK25          |                |
| ZRX 1200 S B1/B2/B3 (ZR 1200)        | 01-03 | CK4434         | CSK38          |                | TS 100 ERN/ERT/ERX                |       |                |                |                |
| ZX 12R (ZX 1200 A1)                  | 00    | CK4513         | CSK109         |                | From F 300564                     | 80-81 | CK3337         | CSK25          |                |
| ZX 12 R (ZX 1200 A2/A3/A4/B1-B4/B6F) | 01-06 | CK4515         | CSK109         |                | TS 100 ERZ/ERH                    | 82    | CK3318         | CSK25          |                |
| ZZR 1200 C1H/C2H                     | 02-04 | CK4488         | CSK29          | SRC25          | DR-Z 110 K3/K4/K5                 | 03-05 | CK4438         | CSK40          |                |
| Z 1300 A1-A3                         | 79-81 | CK4452         | CSK10          |                | 110cc "Smash"                     | 03    | CK4438         | CSK10          |                |
| Z 1300 A4/A5                         | 82-83 | CK4458         | CSK10          |                | B 120                             |       | CK3306         | CSK1           |                |
| ZG 1300 A1-A3                        | 84-86 | CK4455         | CSK7           |                | DF 125                            |       | CK3318         | CSK34          |                |
| GTR 1400 (ZG 1400 A8F)               | 07    | CK4518         | CSK124         |                | DR 125 SZ/SD/SE/SF/SH/SJ          | 82-94 | CK3318         | CSK34          |                |
| ZZR 1400 (ZX 1400 A6F/A7F)           | 06-07 | CK4518         | CSK124         |                | DR 125 SEX/SEY                    | 99-01 | CK3318         | CSK34          |                |
| ZZR 1400 ABS (ZX 1400 B7F)           | 07    | CK4518         | CSK124         |                | DR-Z 125 K3/K4/K5/K6/K7           | 03-07 | CK3318         | CSK34          |                |
| VN 1500 B2/C1/C2/D1                  | 88-96 | CK4455         | N/A            |                | DR-Z 125 LK3/LK4/LK5/LK6/LK7      | 03-07 | CK3318         | CSK34          |                |

CLUTCH APPLICATIONS

# EBC CLUTCH KITS

| MAKE & MODEL  | YEAR  | CLUTCH KIT NO. | SPRING KIT NO. | DRC/SRC SERIES | MAKE & MODEL                               | YEAR     | CLUTCH KIT NO. | SPRING KIT NO. | DRC/SRC SERIES |
|---|-------|----------------|----------------|----------------|--|----------|----------------|----------------|----------------|
| <b>SUZUKI Cont..</b>                                  |       |                |                |                | <b>SUZUKI Cont..</b>                       |          |                |                |                |
| FX 125  |       | CK3318         | CSK34          |                | GSX 250 RCH/RH (GJ72A)                     |          | CK3319         | CSK36          |                |
| GN 125 Z/M/R/V/W/X/Y/K1 (NF41A)                       | 94-01 | CK3318         | CSK34          |                | GSX 250 SSM Katana (GJ76A)                 | 91       | CK3339         | CSK36          |                |
| GP 125 C/N  | 78-79 | CK3319         | CSK25          |                | GSX 250 FXK2 (ZR 250C)                     | 02       | CK4508         | CSK7           |                |
| GP 125 X/XD   | 81-84 | CK3338         | CSK25          |                | GSXR 250 CJ (GJ72A)                        |          | CK3319         | CSK36          |                |
| GS 125 Z/D/ESZ/ESD/ESF                                |       |                |                |                | GSXR 250 CK (GJ72A)                        |          | CK3319         | CSK36          |                |
| ESK/ESM/ESR/ESX                                       | 82-00 | CK3318         | CSK34          |                | GSXR 250 RK (GJ73A)                        | 89       | CK3339         | CSK36          |                |
| GT 125 L/M/A/B/C/EC                                   | 74-80 | CK3318         | CSK25          |                | GN 250 F/J/M/R/T (NJ41A)                   | 85-97    | CK3358         | CSK6           |                |
| GT 125 EN   | 81    | CK3337         | CSK25          |                | GT 250 M/A-C                               | 75-78    | CK3315         | CSK6           |                |
| GZ 125 W/X/Y/K1-K7 'Marauder'                         | 98-07 | CK3318         | CSK34          |                | GT 250 EN/ET/EX 'X7'                       | 79-81    | CK3315         | CSK6           |                |
| LT 125 D/E/F/G/H                                      | 84-86 | CK3328         | N/A            |                | LT-F 250 J/K/L/M/N/P/R/S                   |          |                |                |                |
| RG 125 UCG/UCH/UCJ Gamma                              | 85-91 | CK3319         | CSK25          |                | /T/V/W/Y/K1                                | 89-01    | CK3390         | CSK3           | DRC89          |
| RG 125 FUN/FUP/FUR/FN                                 | 92-96 | CK3319         | CSK34          |                | LT-F4WDH/J/K/L/M/N/P/R/S/T/V/W             | 87-98    | CK3390         | CSK3           | DRC89          |
| RM 125 A/B/C  | 76-78 | CK3329         | CSK25          |                | LT 250 RH/RJ/RK                            | 87-90    | CK3372         | CSK34          | DRC23          |
| RM 125 N/T  | 79-80 | CK3319         | CSK25          |                | LT 250 EFF/EFK                             | 85-86    | CK3390         | CSK48          |                |
| RM 125 X/Z  | 81-82 | CK3329         | CSK36          |                | LT-F 250 FX/FY/FK1/FK2                     | 99-02    | CK3390         | CSK3           | DRC89          |
| RM 125 D  | 83    | CK3329         | CSK34          |                | LT-F 250 K2 'Ozark'                        | 02       | CK3364         | CSK3           |                |
| RM 125 E  | 84    | CK3356         | CSK34          |                | LT-F 250 K3 Ozark                          | 03       | CK3390         | CSK72          |                |
| RM 125 F  | 85    | CK3329         | CSK34          |                | LT-F 250 K4 Ozark                          | 04       | CK3448         | CSK72          |                |
| RM 125 G/H  | 86-87 | CK3319         | CSK1           | DRC21          | LT-F 250 K5/K6/K7 Ozark                    | 05-07    | CK3390         | CSK72          |                |
| RM 125 J/K/L/M  | 88-91 | CK3356         | CSK53          | DRC22          | LT-Z 250 K4/K5/K6 QuadSport                | 04-06    | CK3448         | CSK3           |                |
| RM 125 N  | 92    | CK3401         | CSK32          | DRC114         | 250 SBK2 (LX 250 L)                        | 02       | CK4469         | TBA            |                |
| RM 125 P/R/S/T/V/W                                    | 93-96 | CK3401         | CSK27          | DRC76          | PE 250 B/C/N                               | 77-79    | CK3334         | CSK6           |                |
| RM 125 X/Y/K1   | 97-01 | CK3401         | CSK91          | DRC115         | PE 250 T/X/Z                               | 80-82    | CK3331         | CSK6           |                |
| RM 125 K2/K3/K4/K5/K6/K7                              | 02-07 | CK4514         | CSK91          | DRC130         | RG 250 WD                                  | 83       | CK3384         | CSK6           |                |
| RV 125 K2/K3/K4/K5/K6/K7 "Van-Van"                    | 02-07 | CK3318         | CSK34          |                | RG 250 WE                                  | 84       | CK3351         | CSK6           |                |
| T 125/125-11/R 'Stinger'                              | 69-71 | CK3306         | CSK25          |                | RG 250 FG/FH/CH/FCH                        | 85-88    | CK3351         | CSK6           |                |
| TF 125 Farm Bike (All models)                         | 78-05 | CK3318         | CSK25          |                | RGV 250 J                                  | 88       | CK3351         | CSK7           |                |
| TS 125 K/L/M/A/B/C/C2                                 | 73-78 | CK3318         | CSK25          |                | RGV 250 K/L                                | 89-90    | CK3351         | CSK7           |                |
| TS 125 ERN Up to F No 302345                          | 79    | CK3318         | CSK25          |                | RGV 250 M/N/P/R                            | 91-96    | CK3333         | CSK7           |                |
| TS 125 ERN From F No 302346                           | 79    | CK3337         | CSK25          |                | RM 250 A/B/C                               | 76-78    | CK3334         | CSK6           |                |
| TS 125 ERT/ERX  | 80-81 | CK3337         | CSK25          |                | RM 250 N/T/X/Z/D/E/F                       | 79-85    | CK3331         | CSK6           |                |
| TS 125 ERZ  | 82    | CK3318         | CSK25          |                | RM 250 G                                   | 86       | CK3372         | CSK34          |                |
| TS 125 N to Frame No.178871                           | 84    | CK3318         | CSK25          |                | RM 250 H                                   | 87       | CK3372         | CSK55          | DRC52          |
| TS 125 N from Frame No.178872                         | 84    | CK3337         | CSK25          |                | RM 250 J/K/L                               | 88-90    | CK3374         | CSK27          | DRC24          |
| TS 125 XUE/XUF/XUG/XUH/XUJ                            | 84-90 | CK3319         | CSK25          |                | RM 250 M                                   | 91       | CK3374         | CSK45          | DRC40          |
| TS 125 RK/RL/RM/RN/RR                                 | 90-94 | CK3319         | CSK34          |                | RM 250 N/P                                 | 92-93    | CK3400         | CSK32          | DRC48          |
| TU 125 X Super Classic                                | 99    | TBA            | TBA            |                | RM 250 R/S                                 | 94-95    | CK3374         | CSK32          | DRC72          |
| VL 125 Y/K1-K7 "Intruder"                             | 00-07 | CK3432         | CSK6           |                | RM 250 T                                   | 96       | CK4435         | CSK32          | DRC80          |
| X4 125  |       | TBA            | TBA            |                | RM 250 V/W/X/Y/K1/K2                       | 97-02    | CK4435         | CSK91          | DRC95          |
| LT 160 EK/EL/EM/EN                                    | 89-92 | CK3364         | N/A            |                | RM 250 K3/K4/K5                            | 03-05    | CK3454         | CSK91          | DRC161         |
| LT-F 160 L/M/N/P/R/S/T/V/W/X/Y/K1-K3                  | 90-03 | CK3364         | N/A            |                | RM 250 K6/K7                               | 06-07    | CK3453         | CSK119         | DRC160         |
| LT 160 K3/K4 QuadSport                                | 03-04 | CK3364         |                |                | RMX 250 K/L                                | 89-90    | CK3374         | CSK27          |                |
| PE 175 C/N/T/X/Z                                      | 78-82 | CK3329         | CSK25          |                | RMX 250 M                                  | 91       | CK3374         | CSK45          |                |
| GT 185 K/L/M/A/B/C/EC                                 | 73-82 | CK3319         | CSK25          |                | RMX 250 N/P                                | 92-93    | CK3400         | CSK32          |                |
| LT 185 E/F  | 84-85 | CK3328         | N/A            |                | RMX 250 R/S/T/V/W                          | 94-98    | CK3374         | CSK32          | DRC72          |
| TS 185 K/L/M  | 73-75 | CK3319         | CSK25          |                | RMX 250 ST/SV/SW/SX (SJ14A)                | 96-99    | CK3374         | CSK32          | DRC72          |
| TS 185 B/C  | 77-78 | CK3319         | CSK25          |                | RM-Z 250 K4/K5/K6                          | 04-06    | CK4514         | CSK97          | DRC123         |
| TS 185 ERN/ERT/ERX                                    | 79-81 | CK3319         | CSK25          |                | RM-Z 250 K7                                | 07       | CK4514         | CSK125         |                |
| DF 200 EV/EW/EY (SH42A)                               |       | CK3318         | CSK34          |                | SW-1 (NJ45A)                               | 92       | CK3358         | CSK6           |                |
| DR 200 G/H/J  | 86-89 | CK3319         | CSK1           |                | T 20 'Super Six'                           | 66-68    | CK3310         | CSK76          |                |
| DR 200 SEP/SER/SES/SEV                                |       |                |                |                | T 250 II/R/J                               | 70-72    | CK3313         | CSK6           |                |
| /SEW/SEX/SEY (SH42A)                                  |       | CK3318         | CSK34          |                | TS 250 K/L/M/A/B/C/ERN/ERT/ERX             | 73-81    | CK3315         | CSK6           |                |
| DR 200 SE Trojan                                      |       | CK3319         | CSK34          | DRC94          | TS 250 XE/XG/XH/XJ/XK                      | 85-89    | CK3319         | CSK34          |                |
| DR 200 SEK1-SEK6                                      | 01-05 | CK3319         | CSK34          | DRC94          | TU 250 T/XS/XT/X-ST/XSV Volty              | 92-97    | CK3358         | CSK6           |                |
| GT 200 EN/EX 'X5'                                     | 79-80 | CK3319         | CSK25          |                | TU 250 XTX/XXTY                            |          |                |                |                |
| RV 200 K2/K3  | 02-03 | CK3318         | CSK34          |                | (NJ45A-115-) Volty                         | 99-00    | CK3358         | CSK6           |                |
| SB 200 N/X  | 79-80 | CK3319         | CSK25          |                | TU 250 GY/GBK1 Grass Tracker Big           |          |                |                |                |
| SX 200 R/R-Z/RJ/RM                                    | 90-91 | CK3319         | CSK34          |                | Boy (NJ47A-117/123)                        | 00-01    | CK3358         | CSK6           |                |
| TS 200 RK/RL/RM/RN/RR                                 | 89-94 | CK3329         | CSK34          |                | TV 250 J/K/RK/L (VJ21A) Wolf               | 88-90    | CK3351         | CSK7           |                |
| LT 230 GEF/GEG  | 85-86 | CK3364         | CSK3           |                | VL 250 Y/K1/K5 Intruder                    | 00-01/05 | CK3358         | CSK6           |                |
| LT-F 230 G/H  | 86-87 | CK3364         | CSK3           |                | LT-F 300 J/K                               | 88-89    | CK3390         | CSK48          |                |
| 250 SBK2 (LX 250 L)                                   | 02    | CK4425         | CSK1           |                | LT-F4WDX M/N/P/R/S/T/V/W                   |          |                |                |                |
| DR 250 RS/RLS/RT/RV/RLV/RW                            |       |                |                |                | 300 Quadrunner                             | 91-98    | CK3390         | CSK3           | DRC89          |
| /RLW/RV (SJ45A/DOHC)                                  | 95-00 | CK1181         | CSK46          |                | TU 250 XV/XW                               | 97-00    | CK3358         | CSK6           |                |
| DR 250 RXT/RXLT/RXV/RXLV/RXW/RXLW/RXGW/RXGLW/RXY/RXGY |       |                |                |                | LT-F 300 FX/FY/FK1                         | 99-01    | CK3356         | CSK3           |                |
| (Dejbel 250 XC/GPS Ver (SJ45A))                       |       | CK1181         | CSK46          |                | DR 350 SL/SM/SN/SP/SER/SES/SET/SEV/SEW/SEX | 90-99    | CK3399         | CSK34          | DRC58          |
| DR 250 SL/SM/SN/SEP/SER/SES                           | 90-95 | CK3399         | CSK34          | DRC86          | SG 350 N 'Goose'                           | 92       | CK3399         | CSK34          |                |
| DR-Z 250 K1-K7  | 01-07 | CK1181         | CSK46          |                | T 350 1/2/R/J                              | 69-72    | CK3313         | CSK6           |                |
| GSF 250 N/ZM/P/NP/ZP/R/NR                             | 92-96 | CK3319         | CSK36          |                | SP 370 C/N                                 | 78-79    | CK3334         | CSK6           |                |
| GSF 250 VS/S Bandit                                   | 97    | TBA            | TBA            |                | GT 380 K-M/A/B                             | 73-77    | CK3315         | CSK6           |                |
| GSX 250 ET/EX/EZ                                      | 80-82 | CK3329         | CSK36          |                | DR 400 ST/SX                               | 80-81    | CK3332         | CSK6           |                |
| GS 250 TT/TX  | 80-81 | CK3329         | CSK36          |                |  |          |                |                |                |

CLUTCH APPLICATIONS

■ EP Kevlar Kit available, see page 310

# EBC CLUTCH KITS

CLUTCH APPLICATIONS

| MAKE & MODEL                        | YEAR  | CLUTCH KIT NO. | SPRING KIT NO. | DRC/SRC SERIES | MAKE & MODEL                        | YEAR  | CLUTCH KIT NO. | SPRING KIT NO. | DRC/SRC SERIES |
|-------------------------------------|-------|----------------|----------------|----------------|-------------------------------------|-------|----------------|----------------|----------------|
| <b>SUZUKI Cont..</b>                |       |                |                |                | <b>SUZUKI Cont..</b>                |       |                |                |                |
| DR-Z 400 SY/EY/Y/SK1/EK1/K1/SK2/EK2 |       |                |                |                | GSR 600 K6/AK7                      | 06-07 | CK1218         | CSK75          |                |
| /K2/SK3/EK3/K3/SK4/EK4/K4/EK5/SK5   |       |                |                |                | GSX 600 FJ/FK/FL/FM                 | 88-91 | CK3348         | CSK26          | SRC13          |
| /K6/SK6/EK6/SK7/EK7/K7              | 00-07 | CK3433         | CSK79          | DRC105         | GSX 600 FN/FP/FR/FS/FT/FV           | 92-97 | CK3387         | CSK45          | SRC17          |
| DR-Z 400 SMK5/SMK6/SMK7             | 05-07 | CK3433         | CSK79          | DRC105         | GSX 600 FW/FX/FY/FK1/FK2/FK3        |       |                |                |                |
| GN 400 TT                           | 80    | CK3332         | CSK6           |                | /FK4/FK5/FK6                        | 98-06 | CK3357         | CSK45          | SRC73          |
| GS 400 B/C                          | 77-78 | CK3343         | CSK6           |                | GSXR 600 V/W/X/Y                    | 97-00 | CK1206         | N/A            | SRC58          |
| GSF 400 M/N/P                       | 91-95 | CK3397         | CSK34          |                | GSXR 600 K1/K2/K3/ZK3               | 01-03 | CK1206         | CSK27          | SRC73          |
| GSF 400 K/NK/Z/VM/VZM/P/NP/VP       |       |                |                |                | GSXR 600 K4/K5                      | 04-05 | CK1206         | CSK75          | SRC78          |
| VZR/VR 'Bandit' (GK75A)             | 89-94 | CK3397         | CSK34          |                | GSXR 600 K6/K7                      | 06-07 | CK3455         | CSK69          | SRC86          |
| GSF 400 V/V5/V-V/VZ-V               |       |                |                |                | RF 600 RP/RR/RS/RT                  | 93-96 | CK3408         | CSK45          | SRC45          |
| Bandit (GK7AA)                      |       | CK3397         | CSK34          |                | VS 600 GLS/GLT                      | 95-96 | CK3377         | CSK115         |                |
| GSX 400 ET/EX/EZ                    | 80-82 | CK3333         | CSK6           |                | DL 650 K4/K5/K6 V-Strom             | 04-06 | CK1219         | CSK133         | SRC82          |
| GSX 400 FEX/FZ/FD                   | 81-83 | CK3332         | CSK6           |                | DL 650 AK7 V-Strom ABS              | 07    | CK1219         | CSK133         | SRC82          |
| GSX 400 FW/FWS/FWS-2                |       | CK3332         | CSK6           |                | DL 650 K7                           | 07    | CK1219         | CSK133         | SRC82          |
| GSX 400 R2 (GK71B)                  |       | CK3385         | CSK34          |                | DR 650 RSEM/RSEN/RSEP/              |       |                |                |                |
| GSX 400 R3 (GK71F)                  |       | CK3385         | CSK34          |                | RER/RES                             | 92-95 | CK3402         | CSK115         | DRC59          |
| GSX 400 FJ/FK/FAK/FL (GK74A)        | 88-90 | CK3397         | CSK34          |                | DR 650 SET                          | 96    | CK3386         | CSK4           | DRC87          |
| GSX 400 X/XA/XS 'Impulse'           |       | CK3385         | CSK34          |                | DR 650 RL/RM (SP41A)                | 90-91 | CK3402         | CSK115         | DRC59          |
| GSX 400 R/S/T/X/ZR/ZS/ZT            |       |                |                |                | DR 650 RSL/RSM (SP42A)              | 90-91 | CK3402         | CSK115         |                |
| 'Impulse Type S'                    | 94-99 | CK1177         | CSK6           |                | DR 650 RUN/RN/RUP/RP (SP44A/B)      | 92-93 | CK3402         | CSK115         |                |
| GSX 400 TX/LX                       | 81    | CK3333         | CSK6           |                | GR 650 D/XD                         | 83    | CK3357         | CSK26          |                |
| GSX 400 FSV/FSK1                    |       |                |                |                | GS 650 GX/GZ Katana                 | 81-82 | CK3330         | CSK6           |                |
| (GK7B) Inazuma                      | 00    | CK3359         | CSK6           |                | GS 650 GTX/GTZ/GTD                  | 81-83 | CK3330         | CSK6           |                |
| GSX 400 SSN (GK77A) Katana          | 92    | CK3441         | TBA            |                | GSF 650 K5/SK5/K6/SAK6              | 05-06 | CK3357         | CSK122         |                |
| GSX R 400 H                         | 87    | CK3385         | CSK34          |                | LS 650 Savage FG/PK/PM/PR/PG/PT/PV  | 87-97 | CK3359         | CSK4           |                |
| GSXR 400 J/RR/RAK (GK73A)           | 88-90 | CK3397         | CSK34          |                | SV 650 X/SX/Y/SY/K1/SK1/SK2         | 99-02 | CK3377         | CSK69          | SRC81          |
| GSXR 400 RL/RM/RN/RP/RS (GK76A)     | 90-95 | CK3397         | CSK34          |                | SV 650 K3/SK3/K4/SK4/K5/SK5         |       |                |                |                |
| GSR 400 K6                          | 06    | CK1218         | CSK75          |                | /K6/SK6/ASK7/AK7/K7/SK7             | 03-07 | CK1219         | CSK133         | SRC82          |
| LT-F 400 K2/K3 (Eiger)              | 02-03 | CK4439         | CSK7           |                | XF 650 V/W/X/Y 'Freewind'           | 97-02 | CK3386         | CSK4           |                |
| LT-F 400 FK2-FK7 (Eiger 4WD)        | 02-07 | CK4439         | CSK7           |                | XN 85 D Turbo                       | 83    | CK3347         | CSK6           |                |
| LT-Z 400 K3/K4                      | 03-04 | CK3433         | CSK79          | DRC105         | GS 700 EF/ESF                       | 85    | CK3330         | CSK115         |                |
| LT-Z 400 K5/K6/K7 QuadSport         | 05-07 | CK3447         | CSK79          | DRC137         | VS 700 'All models'                 | 86-87 | CK3377         | CSK115         |                |
| PE 400 T/X                          | 80-81 | CK3332         | CSK6           |                | DR 750 SJ/SK                        | 88-89 | CK3386         | CSK115         |                |
| RF 400 RP/RR/VR/RT/RVT              |       |                |                |                | GT 750 K/L/M/A/B                    | 73-77 | CK3324         | CSK6           |                |
| /RV-V (GK78A)                       |       | CK1177         | CSK6           |                | GS 750 B/DB/DC/EC/EN                | 77-79 | CK3324         | CSK6           |                |
| RG 400 EWF/EW-2G/EWH                |       |                |                |                | GSX 750 ET/EX                       | 80-81 | CK3330         | CSK6           |                |
| Walter Wolf                         | 85-87 | CK4503         | CSK7           |                | GSX 750 ESD/EFE/ESG/ESE/EFF         | 83-86 | CK3330         | CSK115         |                |
| RM 400 C                            | 78    | CK3315         | CSK6           |                | GSX 750 SE Katana                   | 84    | CK3330         | CSK26          |                |
| RM 400 N/T                          | 79-80 | CK3332         | CSK6           |                | GSX 750 FK/FL/FM/FN/FP/FR           |       |                |                |                |
| RV 400 RP/RR                        | 93-   | CK1177         | CSK6           |                | /FS/FT/FV                           | 89-97 | CK3387         | CSK12          |                |
| SP 400 T                            | 80    | CK3332         | CSK6           |                | GSX 750 FW/FX/FY/FK1-FK6            | 98-06 | CK3357         | CSK45          |                |
| VS 400 VR/FR/VTR/FTR                |       |                |                |                | GSX 750 W/X/Y/K1                    | 98-03 | CK3357         | CSK45          |                |
| /VT/FT 'Intruder'                   | 94-   | CK3377         | CSK26          |                | GSX 750 S/SS (GS75X-106815-)        |       | CK3330         | CSK6           |                |
| GS 425 EN                           | 79    | CK3343         | CSK6           |                | GSX 750 S-2/S-2C                    |       |                |                |                |
| GS 450 ET/EG/EJ                     | 80-88 | CK3333         | CSK6           |                | (GS75X-114747-) Katana              |       | CK3330         | CSK6           |                |
| LT-R 450 K6/K7                      | 06-07 | CK3450         | CSK125         |                | GSXR 750 F/G/H (GR75A)              | 85-87 | CK3348         | CSK115         | SRC13          |
| RM-Z 450 K5/K6/K7                   | 05-07 | CK3450         | CSK119         | DRC155         | GSXR 750 J/K                        | 88-89 | CK3387         | CSK12          | SRC14          |
| RM 465 X/Z                          | 81-82 | CK3348         | CSK6           |                | GSXR 750 L/M/WN/WP/WR/WS            | 90-95 | CK3387         | CSK45          | SRC17          |
| DR 500 X/Z/D                        | 81-83 | CK3359         | CSK26          |                | GSXR 750 T/V/W/X                    | 96-99 | CK3417         | N/A            | SRC40          |
| DR 500 S/SA                         | 84-88 | TBA            | TBA            |                | GSXR 750 Y/K1                       | 00-01 | CK1229         | CSK75          | SRC71          |
| LT 500 RL/RM                        | 90-91 | CK3374         | CSK34          | DRC26          | GSXR 750 K2/K3/K4/K5                | 02-05 | CK3417         | CSK75          |                |
| LT-F 500 FW/FX/FY/FK1/FK2           | 98-02 | CK4439         | CSK7           |                | GSXR 750 K6/K7                      | 06-07 | CK3456         | CSK69          | SRC88          |
| LT-F 500 FK3-FK7                    | 03-07 | CK3452         | CSK7           |                | VS 750 GLF/GLFG/GLFH/GLPG/GLPK/GLPL |       |                |                |                |
| GS 500 EK/EL/EM/EN/EP/ER/ES/ET/EV   |       |                |                |                | /GLPM/GLPH/GLEFH/GLEPH (VR51A)      | 85-91 | CK3377         | CSK115         |                |
| /EW/EX/EY/K1/K2/K3/K4/FK4/F5/FK5    |       |                |                |                | DR 800 SL/SM                        | 90-91 | CK3386         | CSK115         |                |
| /K6/FK6/K7/FK7                      | 89-07 | CK3333         | CSK61          |                | VS 800 GLN/GLP/GLR/GLS/GLT/GLV      | 92-97 | CK3377         | CSK115         |                |
| GT 500 A/B                          | 76-77 | CK3316         | CSK6           |                | VZ 800 V/W/X/Y/K1/K2 Marauder       | 97-03 | CK3377         | N/A            |                |
| RE 5 M/A                            | 75-76 | CK3373         | CSK6           |                | VX 800 L/M/N/P/R                    | 90-96 | CK3377         | N/A            |                |
| RG 500 G/CH                         | 85-87 | CK4503         | CSK7           |                | VL 800 K1-K4 Intruder Volusia       | 01-04 | CK3377         | TBA            |                |
| RM 500 D                            | 83    | CK3348         | CSK6           |                | VL 800 K5/K6/K7 (800 Intruder)      | 05-07 | CK3377         | N/A            |                |
| T 500 1/2/3 (18 ears)               | 68-70 | CK3314         | CSK6           |                | VZ 800 K5-K7 Intruder M800          | 05-07 | CK3377         | N/A            |                |
| T 500 R/J/K/L/M (12 ears)           | 71-75 | CK3316         | CSK6           |                | GS 850 GN/GT/GX/GZ/GF/GG            | 79-85 | CK3330         | CSK6           |                |
| GT 550 K/L/M/A/B                    | 73-77 | CK3321         | CSK6           |                | RF 900 RR                           | 94    | CK3418         | N/A            |                |
| GS 550 DB/DC/EC/EN/ET/EX/EZ         | 77-82 | CK3344         | CSK6           |                | RF 900 RS/R2S/RT/RV/RW              | 95-98 | CK3417         | CSK29          |                |
| GS 550 MX/MZ Katana                 | 81-82 | CK3344         | CSK6           |                | DL 1000 K2-K7 'V-Strom'             | 02-07 | CK3443         | CSK43          |                |
| GS 550 LT/LX                        | 80-81 | CK3344         | CSK6           |                | GS 1000 HC/EC/EN/SN/ET              | 78-80 | CK3345         | CSK6           |                |
| GSX 550 ESD/ESE/EFF                 |       |                |                |                | GS 1000 GT/GX                       | 80-81 | CK3335         | CSK6           | SRC50          |
| EFE/ESH/EFG (GN71D)                 | 84-87 | CK3344         | CSK6           |                | GSX 1000 SZ                         | 82    | CK3335         | CSK6           | SRC50          |
| DR 600 RG/RH/SG/SH (SN41A)          | 86-87 | CK3359         | CSK98          |                | GSXR 1000 K1/K2/K3/K4               | 01-04 | CK4510         | CSK128         | SRC89          |
| DR 600 SF (SN41A)                   | 85    | CK3359         | CSK115         |                | GSXR 1000 K5/K6                     | 05-06 | CK3451         | CSK69          | SRC85          |
| GSF 600 T/ST/V/SV/M/SW/X/SX         | 96-99 | CK3348         | CSK45          |                | GSXR 1000 K7                        | 07    | TBA            | TBA            |                |
| GSF 600 Y/SY/K1/SK1//SK2/K2/K3      |       |                |                |                | SV 1000 K3/SK3/K4/SK4/K5/SK5        |       |                |                |                |
| /SK3/K4/SK4 Bandit                  | 00-04 | CK3348         | CSK45          |                | /SK6                                | 03-06 | CK3443         | CSK114         |                |

# EBC CLUTCH KITS

| MAKE & MODEL                            | YEAR  | CLUTCH KIT NO. | SPRING KIT NO. | DRC/SRC SERIES | MAKE & MODEL                           | YEAR  | CLUTCH KIT NO. | SPRING KIT NO. | DRC/SRC SERIES |
|---|-------|----------------|----------------|----------------|--|-------|----------------|----------------|----------------|
| <b>SUZUKI Cont..</b>                    |       |                |                |                | <b>YAMAHA Cont..</b>                   |       |                |                |                |
| TL 1000 SV/SW                           | 97-98 | CK3417         | CSK78          |                | YFM 80 GT/GV/GW Grizzly                | 05-07 | CK2303         | N/A            |                |
| TL 1000 RW/RX/SX/RY/SY                  | 98-00 | CK3428         | CSK71          | SRC68          | YZ 80 D                                | 77    | CK2238         | CSK42          |                |
| TL 1000 SK1                             | 01-02 | CK3435         | CSK71          |                | YZ 80 E/F                              | 78-79 | CK2254         | CSK42          |                |
| TL 1000 RK1                             | 01-02 | CK3435         | CSK71          |                | YZ 80 G                                | 80    | CK2238         | CSK42          |                |
| GS 1100 GZ                              | 82    | CK3335         | CSK6           | SRC50          | YZ 80 H/J/K/L/N                        | 81-85 | CK2287         | CSK42          |                |
| GSX 1100 ET/EX/EZ                       | 80-82 | CK3335         | CSK6           | SRC50          | YZ 80 S/T/U/W                          | 86-89 | CK2304         | CSK42          | DRC27■         |
| GSX 1100 SZ                             | 82    | CK3335         | CSK6           | SRC50          | YZ 80 E/LC/LW/F                        | 93-94 | CK2304         | CSK39          | DRC66          |
| GSX 1100 SD/ESD                         | 83    | CK3346         | CSK6           |                | YZ 80 G/H/J/K/L/M/N                    | 95-01 | CK2335         | CSK42          | DRC78■         |
| GSX 1100 EFE/EFG/ESF                    | 84-86 | CK3335         | CSK6           | SRC50          | YZ 85 P/LWP/R/LWR/S/LWS/T/LWT/V        |       |                |                |                |
| GSX 1100 FJ/FK/FL/FM/FN/FP              | 88-93 | CK3381         | CSK12          |                | /LWV/W/LWW                             | 02-07 | CK2335         | CSK42          | DRC111         |
| GSX 1100 GM/GN                          | 91-94 | CK3392         | N/A            |                | TT-R 90 M/N/P/R/ES/S/ET/T/EV/EW        | 00-07 | CK2354         | N/A            |                |
| GSX R 1100 G/H/J                        | 86-88 | CK3381         | CSK26          | SRC15          | T 90 N/D (4NM1-9) Mate                 | 00-   | CK2354         | N/A            |                |
| GSXR 1100 K/L/M/N                       | 89-92 | CK3392         | N/A            | SRC10          | AG 100 E Farm Bike                     | 93    | CK2208         | CSK1           |                |
| GSXR 1100 WP/WR/WS/WT                   | 93-96 | CK3418         | N/A            | SRC39          | AG 100 J (3HAA)                        | 82    | CK2208         | CSK1           |                |
| GS 1200 SSK/ZK1 (GV78A)                 |       | CK3417         | N/A            | SRC40          | DT 100                                 | 76-80 | CK2236         | CSK42          |                |
| GSF 1200 T/STV/SV/W/SW/X/SX/Y/SY/K1/SK1 |       |                |                |                | RS 100                                 | 75-76 | CK2208         | CSK42          |                |
| /K2/SK2/K3/SK3/K4/SK4/K5/SK5 Bandit     | 96-05 | CK3417         | N/A            | SRC40          | RS 100/RS 100 'S'                      | 77-78 | CK2254         | CSK42          |                |
| GSF 1200 SAV ABS Bandit                 | 97    | CK3417         | N/A            | SRC40          | RS 100/RS 100 DX                       | 79    | CK2254         | CSK42          |                |
| GSF 1200 K6/SAK6/GTSAK6                 | 06    | CK3417         | N/A            | SRC40          | RS 100                                 | 80-81 | CK2254         | CSK42          |                |
| GSX 1200 FSW/FSX Inazuma                | 98-99 | CK3417         | N/A            |                | RT 100 E/F/K                           | 93-03 | CK2254         | CSK1           |                |
| GV 1200 GLF/GLF2/GLG 'Madura'           | 85-86 | CK3375         | CSK115         |                | RX S 100                               | 83-97 | CK2254         | CSK1           |                |
| GSF 1250 AK7/ASK7 Bandit                | 07    | TBA            | TBA            |                | YB 100                                 | 78-92 | CK2207         | N/A            |                |
| GSX 1300 RX/RY/RK1 Hayabusa             | 99-01 | CK3430         | CSK72          | SRC67          | YZ 100 E/F/G/H/J/K                     | 78-83 | CK2234         | CSK39          |                |
| GSX 1300 RK2/RK3/RK3/RK4/RK5/K6/K7      | 02-07 | CK3443         | CSK72          |                | T 105/105 E Crypton                    | 96    | CK2354         | N/A            |                |
| GSX 1400 K1                             | 01    | CK3445         | CSK89          |                | T 105 E (5ER1/2)                       | 99    | CK2354         | N/A            |                |
| GSX 1400 K2/K3/K4/K5/K6/K7              | 02-07 | CK3439         | CSK89          |                | V 110 ZE/ZK/ZHE/ZHK 'FIZR'/FIZR Sporty |       | CK2354         | N/A            |                |
| GV 1400 'Cavalcade' (All models)        | 85-88 | CK3388         | CSK115         |                | RX 115 (5FS3)                          | 99    | CK2254         | CSK42          |                |
| VS 1400 GLPH/GLPJ/GLFH/GLFJ/GLPR/GLPT   |       |                |                |                | DT 125                                 | 74    | CK2209         | CSK42          |                |
| /GLPV/GLPW/GLPY/GLPK1/GLPK2             | 87-03 | CK3382         | N/A            |                | DT 125/125 F                           | 76-77 | CK2236         | CSK39          |                |
| VL 1500 W/X/Y/K1/K2/K3 "Intruder        |       |                |                |                | DT 125 E                               | 78-79 | CK2236         | CSK1           |                |
| Legendary Classic"                      | 98-03 | CK3335         | CSK31          |                | DT 125 MX                              | 80-81 | CK2236         | CSK42          |                |
| VL 1500 K5/K6/K7 (C 1500 Intruder)      | 05-07 | CK3335         | CSK31          |                | DT 125 LC Type 10V                     | 82    | CK2281         | CSK42          |                |
| VZ 1600 K4 Marauder                     | 04    | CK4455         | N/A            |                | DT 125 LC Type 12W                     | 82    | CK2281         | CSK42          |                |
| VZ 1600 K5 (M 1600 Intruder)            | 05    | CK4455         | N/A            |                | DT 125 LC Type 26G                     | 83    | CK2281         | CSK42          |                |
| VZR 1800 K6/K7 (M 1800 R Intruder)      | 06-07 | CK3457         | CSK122         |                | DT 125 LC Type 35A                     | 85-87 | CK2283         | CSK42          |                |
| <b>YAMAHA</b>                           |       |                |                |                |  |       |                |                |                |
| FS 1 E/FS 1 DX                          | 74-80 | CK2205         | CSK42          |                | DT 125 R                               | 88-03 | CK2313         | CSK42          | DRC42          |
| FS 1                                    | 87-90 | CK2205         | CSK42          |                | DT 125 RE                              | 04-07 | CK2313         | CSK42          | DRC42          |
| FS 1 SE                                 | 81-82 | CK2205         | CSK42          |                | DT 125 (3TT4)                          | 96    | CK2283         | CSK42          |                |
| DT 50 M                                 | 78-79 | CK2206         | CSK42          |                | DT 125 X                               | 05-06 | CK2313         | CSK42          | DRC42          |
| DT 50 M/MX                              | 80-95 | CK2205         | CSK42          |                | IT 125 G/H/J                           | 80-82 | CK2229         | CSK42          |                |
| DT 50 LC                                | 98    | CK2206         | CSK42          |                | RD 125 DX                              | 75-76 | CK2236         | CSK42          |                |
| DT 50 R                                 | 97-07 | CK2348         | N/A            |                | RD 125 DX                              | 78-81 | CK2254         | CSK42          |                |
| DT 50 X (Supermotard)                   | 04-07 | CK2348         | N/A            |                | RD 125 LC (MK1-MK3)                    | 82-87 | CK2283         | CSK42          |                |
| RD 50 M                                 | 78-79 | CK2206         | CSK42          |                | RZ 125 (1GV 030101-)                   | 85    | CK2283         | CSK42          |                |
| RD 50 M/MX                              | 80-83 | CK2205         | CSK42          |                | RS 125/RS 125 DX                       | 75-76 | CK2236         | CSK42          |                |
| RD 50                                   | 86-87 | CK2205         | CSK42          |                | RS 125                                 | 77-81 | CK2254         | CSK42          |                |
| RZ 50 (5FC1/2)                          | 02    | CK2238         | CSK42          |                | SR 125 SE                              | 81-83 | CK2256         | CSK52          |                |
| TT 50 EV/EW                             | 06-07 | TBA            | N/A            |                | SR 125                                 | 89-03 | CK2256         | CSK52          |                |
| TY 50/TY 50 M (1F4/1G7)                 | 77-78 | CK2206         | CSK42          |                | TDR 125 (3HS/3XD1)                     | 89-93 | CK2313         | CSK42          |                |
| TY 50 M (2K0)                           | 80    | CK2205         | CSK42          |                | TDR 125                                | 93-03 | CK2313         | CSK42          | DRC42          |
| T 50                                    | 86    | CK2302         | N/A            |                | TT-R 125 M/LWM/N/LWN/P/LWP/R           |       |                |                |                |
| TZR 50 (5DU1/3)                         | 97-00 | CK2349         | N/A            |                | /LWR/LWES/LWS/S/ES/T/ET/LWT            |       |                |                |                |
| TZR 50 (5WX1)                           | 03-07 | CK2349         | N/A            |                | /LWET/EV/LV/LEV/EW/LEW                 |       |                |                |                |
| V 50 M/P                                | 75-77 | CK2303         | N/A            |                | /LWEW                                  | 00-07 | CK2254         | CSK42          |                |
| YFM 50 S/T/RV Raptor                    | 04-06 | CK2303         | N/A            |                | TW 125                                 | 99-04 | CK2256         | CSK52          |                |
| YZ 50 G/H/J/K                           | 80-83 | CK2206         | CSK42          |                | TZR 125                                | 87-93 | CK2304         | CSK42          |                |
| DT 80 LC/LCII (37A/53A)                 | 81-92 | CK2238         | CSK42          |                | TZR 125 R/RR                           | 93-95 | CK2313         | CSK42          | DRC42          |
| DT 80 MX Type 5J2                       | 81-82 | CK2206         | CSK42          |                | TY 125                                 | 80-82 | CK2234         | CSK42          |                |
| DT 80 MX Type 12X                       | 83    | CK2206         | CSK42          |                | XV 125 'Virago'                        | 97-00 | CK2316         | CSK2           |                |
| DT 80 MX Type 36N                       | 83-85 | CK2238         | CSK1           |                | XVS 125 Drag Star                      | 00-03 | CK2316         | CSK2           |                |
| DT 80 MXS                               | 84    | CK2238         | CSK42          |                | XT 125                                 | 82-83 | CK2256         | CSK52          |                |
| PW 80 (All models)                      | 83-06 | CK2303         | N/A            |                | XT 125 R                               | 06-07 | CK2254         | CSK42          |                |
| RD 80                                   | 82    | CK2206         | CSK42          |                | XT 125 X                               | 06-07 | CK2254         | CSK42          |                |
| RD 80 LC                                | 82    | CK2238         | CSK42          |                | XTZ 125 K/E                            | 05-07 | CK2254         | CSK42          |                |
| T 80                                    | 83-97 | CK2303         | N/A            |                | YBR 125 ED (3D91)                      | 06-07 | CK1151         | N/A            |                |
| TY 80                                   | 77-83 | CK2206         | CSK42          |                | YZ 125 C                               | 76    | CK2234         | CSK39          |                |
| V 80                                    | 79-83 | CK2303         | N/A            |                | YZ 125 D/E                             | 77-78 | CK2235         | CSK39          |                |
| YFM 80 D/E/F/G/H/J/K/L/M                |       |                |                |                | YZ 125 F                               | 79    | CK2234         | CSK42          |                |
| /N Badger                               | 91-01 | CK2303         | N/A            |                | YZ 125 G                               | 80    | CK2234         | CSK39          |                |
| YFM 80 WP/WR/WS/RT/RV                   |       |                |                |                | YZ 125 H                               | 81    | CK2235         | CSK39          |                |
| /RW Raptor                              | 02-07 | CK2303         | N/A            |                | YZ 125 J                               | 82    | CK2276         | CSK39          |                |
|   |       |                |                |                | YZ 125 K/L/N                           | 83-85 | CK2278         | CSK39          |                |
|   |       |                |                |                | YZ 125 S/T                             | 86-87 | CK2278         | CSK2           | DRC28          |

CLUTCH APPLICATIONS

■ EP Kevlar Kit available, see page 310

# EBC CLUTCH KITS

CLUTCH APPLICATIONS

| MAKE & MODEL                             | YEAR  | CLUTCH KIT NO. | SPRING KIT NO. | DRC/SRC SERIES | MAKE & MODEL                       | YEAR  | CLUTCH KIT NO. | SPRING KIT NO. | DRC/SRC SERIES |
|--|-------|----------------|----------------|----------------|------------------------------------|-------|----------------|----------------|----------------|
| <b>YAMAHA Cont..</b>                     |       |                |                |                | <b>YAMAHA Cont..</b>               |       |                |                |                |
| YZ 125 U                                 | 88    | CK2312         | CSK2           | DRC29          | YFB 250 D/E/F/G/H/J/K/FWF/FWG      |       |                |                |                |
| YZ 125 W/A                               | 89-90 | CK2311         | CSK2           | DRC30■         | /FWH/FWJ/FWK/FWL/FWM               | 92-00 | CK2287         | CSK2           |                |
| YZ 125 B/D                               | 91-92 | CK2319         | CSK81          | DRC39■         | YFM 250 W/A/B                      | 90-92 | CK2287         | N/A            |                |
| YZ 125 E/F/G/H/J/K/L/M/N                 | 93-01 | CK2325         | CSK81          | DRC70■         | YFM 250 XN/XP/XR/XS "Bear Tracker" | 00-04 | CK2287         | CSK52          |                |
| YZ 125 P/R/S                             | 02-04 | CK2325         | CSK14          | DRC85■         | YFM 250 FN                         | 01    | CK2287         | CSK52          | DRC104         |
| YZ 125 T/V/W                             | 05-07 | CK2325         | CSK81          | DRC70■         | YFM 250 BT/BV Bruin                | 05-06 | CK2287         | CSK52          |                |
| RX 135 (13X)                             | 81    | CK2283         | CSK42          |                | YTZ 250 N/S (TRI Z)                | 85-86 | CK2280         | CSK2           |                |
| TZR 150 R (4AP2)                         | 00    | CK2313         | CSK42          |                | XS 250 C/D/E                       | 78-80 | CK2279         | CSK2           |                |
| DT 175                                   | 74-75 | CK2236         | CSK42          |                | XS 250 SE/C                        | 80-81 | CK2250         | CSK49          |                |
| DT 175                                   | 76-77 | CK2236         | CSK39          |                | XV 250 S Virago                    | 95-00 | CK2316         | CSK2           |                |
| DT 175 MX                                | 78-81 | CK2245         | CSK42          |                | XVS 250 Dragstar                   | 01-04 | CK2250         | CSK2           |                |
| DT 175 (3TS4)                            | 96    | CK2365         | CSK42          |                | XT 250                             | 80    | CK2267         | CSK1           |                |
| IT 175 G/H/J                             | 80-82 | CK2235         | CSK39          |                | YFM 250 BW Big Bear                | 07    | CK2287         | CSK52          |                |
| TY 175                                   | 77-80 | CK2234         | CSK42          |                | YZ 250 D/E                         | 77-78 | CK2244         | CSK2           |                |
| AG 200 E (3GX6)                          | 93    | CK2292         | N/A            |                | YZ 250 F                           | 79    | CK2250         | CSK2           |                |
| DT 200 (2LR)                             | 87    | CK2313         | CSK42          |                | YZ 250 G                           | 80    | CK2244         | CSK2           |                |
| DT 200 WR 3XP                            | 92-93 | CK2313         | CSK42          |                | YZ 250 H                           | 81    | CK2279         | CSK2           |                |
| IT 200 L                                 | 84    | CK2235         | CSK1           |                | YZ 250 J/K/L                       | 82-84 | CK2280         | CSK2           |                |
| RD 200 DX                                | 76-81 | CK2209         | CSK42          |                | YZ 250 N/T                         | 85/87 | CK2280         | CSK103         | DRC35■         |
| RS 200                                   | 79-80 | CK2209         | CSK42          |                | YZ 250 S                           | 86    | CK2280         | CSK2           |                |
| SDR 200 (2TV)                            | 87-89 | CK2313         | CSK42          | DRC42          | YZ 250 U/W/A/B/D                   | 88-92 | CK2309         | CSK81          | DRC31■         |
| TW 200 (2JL/4CS1/2/3/4/5/6/5LB1/2)       | 01-02 | CK2234         | N/A            |                | YZ 250 E/F/G/H/J/L                 | 93-99 | CK2274         | CSK81          | DRC71■         |
| WR 200 D/E/F                             | 92-94 | CK2313         | CSK42          | DRC42          | YZ 250 M/N                         | 00-01 | CK2274         | CSK49          | DRC97■         |
| YFM 200 DKW/DX/DXA                       | 86-90 | CK2287         | N/A            |                | YZ 250 P/R/S/T/V/W                 | 02-07 | CK2274         | CSK92          | DRC113         |
| YFS 200 B/F/G/H/J/K/L/M/N/P/R/S/T/V      |       |                |                |                | YZ 250 FN/FP/FR/FS/FT/FV/FW        | 01-07 | CK2355         | CSK81          | DRC109         |
| 'Blaster'                                | 91-06 | CK2313         | CSK42          | DRC42          | YZ 250 WRW/WRA                     | 89-90 | CK2309         | CSK24          |                |
| YTM 200 EL/DX                            | 89    | CK2304         | N/A            |                | WR 250 ZB/ZD/ZE                    | 91-93 | CK2309         | CSK81          |                |
| ST 225 (5BT) Bronco                      | 97    | CK2324         | N/A            |                | WR 250 ZF/ZG/ZH/ZJ/ZK              | 94-98 | CK2274         | CSK81          |                |
| TDM 225                                  | 05    | TBA            | TBA            |                | WR 250 FN/FP/FR/FS/FT/FV/FW        | 01-07 | CK2355         | CSK12          | DRC119         |
| TW 225 (5VC1/2)                          | 03    | CK2234         | N/A            |                | RD 350 A/B                         | 74-75 | CK2240         | CSK2           |                |
| XT 225 (2LN) Serrow (1KH 020101-)        | 86-87 | CK2324         | N/A            |                | RD 350 LC/YPVS                     | 80-84 | CK2240         | CSK2           |                |
| XT 225 (3RW1-5 Serrow)                   |       |                |                |                | RD 350 N/F/F2/R                    | 85-95 | CK2240         | CSK2           |                |
| (1KH 034101-132000)                      | 89-93 | CK2324         | N/A            |                | RIZ 350                            | 92    | CK2307         | CSK52          |                |
| YFM 225 N/S/T/U                          | 85-89 | CK2287         | N/A            |                | TT 350 A (3GJ)                     | 90-95 | CK2240         | CSK14          |                |
| YTM 225 DRN                              | 85    | CK2287         | N/A            |                | XT 350                             | 85-95 | CK2240         | CSK14          | DRC56■         |
| DT 230 R 'Lanza' (4TP1/2)                | 97-98 | CK2313         | CSK42          | DRC42          | YFM 350 FWT/FWU/FWW/FWA            |       |                |                |                |
| DT 250                                   | 75-76 | CK2240         | CSK2           |                | /FWE Big Bear                      | 86-93 | CK2290         | CSK58          | DRC33          |
| DT 250 MX                                | 77-80 | CK2223         | CSK2           |                | YFM 350 FWF/FWG/FWH/FWJ            | 94-97 | CK2290         | CSK49          | DRC82          |
| FZR 250                                  | 87    | CK2331         | CSK34          |                | YFM 350 XD/XE/XF/XG/XH/XJ          |       |                |                |                |
| FZR 250 R (3LN1/3/5/6/7)                 |       | CK2331         | CSK34          |                | /XK/XL/XM/XN/XP/XR/XS              | 92-04 | CK2290         | CSK58          |                |
| FZX 250 Zeal (3YX1/2/4)                  | 91-92 | CK2331         | CSK34          |                | YFM 350 ERD/ERE/ERF                | 92-94 | CK2290         | CSK58          |                |
| IT 250 G                                 | 80    | CK2250         | CSK2           |                | YFM 350 ERG                        | 95    | CK2290         | CSK49          |                |
| IT 250 H/J                               | 81-82 | CK2279         | CSK2           |                | YFM 350 FX 'Wolverine' All models  | 95-04 | CK2240         | CSK24          |                |
| IT 250 L                                 | 84    | CK2280         | CSK2           |                | YFM 350 UH/UJ                      | 96-97 | CK2290         | CSK49          |                |
| RD 250 A/B/C/D/E/F                       | 75-79 | CK2240         | CSK2           |                | YFM 350 S/T/V/R-WV/RW Raptor       | 04-07 | CK2290         | CSK58          | DRC33          |
| RD 250 LC                                | 80-82 | CK2240         | CSK2           |                | YFU1W/T                            | 89-90 | CK2287         | N/A            |                |
| RZ 250 R (1AR/1XG)                       |       | CK2240         | CSK2           |                | YFZ 350 U/A/B/D/E/F/G/H/J/K        |       |                |                |                |
| RZ 250 R (29L)                           |       | CK2240         | CSK2           |                | /L/M/N/P/R/S/T/V Banshee           | 90-06 | CK2240         | CSK2           | DRC43          |
| RZ 250 RR (51L)                          |       | CK2240         | CSK2           |                | DT 400                             | 75-76 | CK2240         | CSK2           |                |
| RZ 250 (4L3)                             |       | CK2240         | CSK2           |                | DT 400 MX                          | 77-79 | CK2290         | CSK2           |                |
| Serrow 250 (3C51/52)                     | 06    | CK2337         | CSK81          |                | FZ 400 N (IFK/33M/46X)             | 85-   | CK2255         | CSK14          |                |
| SR 250                                   | 80    | CK2267         | CSK2           |                | FZR 400 RR (4DX)                   | 92    | CK2317         | CSK42          | SRC6           |
| SR 250 SE                                | 81-82 | CK2261         | CSK2           |                | FZR 400 Genesis (1WG)              | 86    | CK2317         | CSK42          | SRC6           |
| SR 250                                   | 93-94 | CK2336         | CSK2           |                | FZR 400 RSP (2TK-EXUP)             | 87    | CK2315         | CSK42          | SRC7           |
| SRV 250 'Soulful Twin/Renaissa' (4DN1-6) | 92-97 | CK2316         | N/A            |                | FZR 400 (3EN1/3EN2)                | 88-89 | CK2317         | CSK42          | SRC6           |
| SRX 250                                  |       | CK2261         | CSK49          |                | FZR 400 RR (3TJl)                  |       | CK2317         | CSK42          | SRC6           |
| TDR 250                                  | 88-92 | CK2319         | CSK52          |                | FZR 400 RRSP (3TJ2/6/7)            |       | CK2315         | CSK42          | SRC7           |
| TT 250 RH/RL                             | 96-99 | CK2337         | CSK49          |                | RD 400 C/D/E/F                     | 76-79 | CK2240         | CSK2           |                |
| TT 250 RL/RM/RN/RR/RS                    | 00-04 | CK2319         | CSK14          |                | SR 400                             |       | CK2296         | CSK14          |                |
| TYR 250 D/E                              | 77-78 | CK2240         | CSK2           |                | SRX 400 (1JL)                      |       | CK2297         | CSK81          |                |
| TY 250 S/R                               | 84-90 | CK2295         | CSK59          |                | SRX 400 (3VN1/3VN2/3VN5)           | 90-96 | CK2297         | CSK81          |                |
| TY 250 R                                 | 91-92 | CK2295         | CSK59          |                | XJR 400 (4HM1/4HM2/4HM4/4HM7)      | 93-96 | CK2255         | CSK81          |                |
| TYZ 250 R                                | 93-96 | CK2319         | CSK2           |                | XJR 400 (4HM3/4HM5/4HM6/4HM9       |       |                |                |                |
| TZR 250 (2MA/2XW)                        | 87-92 | CK2319         | CSK52          |                | /4HMA/4HMB)                        | 95-99 | CK2255         | CSK81          |                |
| TZR 250 (3MA1/3/5)                       | 89-90 | CK2342         | CSK24          |                | XS 400                             | 78-79 | CK2279         | CSK2           |                |
| TZR 250 SP (3MA4)                        | 90    | N/A            | CSK2           |                | XS 400                             | 82    | CK2262         | CSK2           |                |
| TZR 250 R (3XV1/4/6)                     | 91    | CK2319         | CSK14          |                | XS 400 SE                          | 80    | CK2279         | CSK2           |                |
| TZR 250 (1KT/2AW)                        | 87    | CK2319         | CSK52          |                | XVS 400                            | 96    | CK2299         | CSK91          |                |
| XG 250 Tricker (5XT1)                    | 04-06 | CK2337         | CSK81          |                | YFM 400 FWE/FWF/FWG/FWH/           |       |                |                |                |
| XT 250 X                                 | 06    | CK2337         | CSK81          |                | FWJ/FWK 'Kodiak'                   | 93-00 | CK2290         | CSK49          |                |
| XV 250 Virago                            | 89-94 | CK2316         | CSK2           |                | YFM 400 FPR/FPS Big Bear           | 03-04 | CK2290         | CSK49          | DRC82          |
| YBR 250                                  | 07    | TBA            | TBA            |                | YZ 400 D/E/F                       | 77-79 | CK2279         | CSK2           |                |
|  |       |                |                |                | YZ 400 FK/FL                       | 98-99 | CK2310         | CSK49          | DRC99■         |



# EBC CLUTCH KITS

| MAKE & MODEL            | YEAR  | CLUTCH KIT NO. | SPRING KIT NO. | DRC/SRC SERIES | MAKE & MODEL                                  | YEAR  | CLUTCH KIT NO. | SPRING KIT NO. | DRC/SRC SERIES |
|-------------------------|-------|----------------|----------------|----------------|---|-------|----------------|----------------|----------------|
| <b>YAMAHA Cont..</b>    |       |                |                |                | <b>YAMAHA Cont..</b>                          |       |                |                |                |
| WR 400 FK/FL/FM/FN      | 98-01 | CK2310         | CSK49          | DRC99■         | XS 650 SE                                     | 79-81 | CK2242         | CSK14          |                |
| IT 425 G                | 80    | CK2279         | CSK2           |                | XVS 650 Dragstar                              | 97-04 | CK2309         | CSK91          |                |
| WR 426 FN/FP            | 01-02 | CK2356         | CSK62          | DRC110         | XVS 650 A Dragstar Classic                    | 98-07 | CK2309         | CSK91          |                |
| YZ 426 FM               | 00    | CK2352         | CSK49          | DRC102■        | MT 03 (660cc)                                 | 06    | CK2368         | CSK123         |                |
| YZ 426 FN/FP            | 01-02 | CK2356         | CSK62          | DRC110         | SZR 660                                       | 96-97 | CK2297         | CSK14          | DRC88          |
| WR 450 FR/FS            | 03-04 | CK2356         | CSK62          | DRC110         | XTZ 660 'Tenere'                              | 91-97 | CK2297         | CSK14          | DRC88          |
| WR 450 FT/FV/FW         | 05-07 | CK2274         | CSK92          |                | XT 660 X Supermoto                            | 04-07 | CK2368         | CSK123         |                |
| YZ 450 FR/FS            | 03-04 | CK2352         | CSK92          | DRC121         | XT 660 R                                      | 04-07 | CK2368         | CSK123         |                |
| YZ 450 FT/FV            | 05-06 | CK2352         | CSK58          | DRC162         | YFM 660 RN/RP/RR/RS/RT Raptor                 | 01-05 | CK2297         | CSK14          | DRC88          |
| YZ 450 FW               | 07    | CK2274         | CSK37          |                | FZX 700 S/SC/TC 'Fazer'                       | 86-87 | CK2255         | CSK17          | SRC51          |
| YFZ 450 S/TV/W          | 04-07 | CK2364         | CSK17          | DRC159         | YFM 700 RV/RW Raptor                          | 06-07 | CK2364         | CSK37          | DRC159         |
| IT 465 H/J              | 81-82 | CK2279         | CSK2           |                | FZ 750  | 85-86 | CK2255         | CSK17          | SRC51          |
| YZ 465 G/H              | 80-81 | CK2279         | CSK2           |                | FZ 750  | 87-92 | CK2306         | CSK17          |                |
| IT 490 L                | 84    | CK2280         | CSK2           |                | FZX 750                                       | 87    | CK2306         | CSK17          |                |
| YZ 490 J/K/L/N/S/T/U    | 82-88 | CK2280         | CSK2           | DRC32          | FZR 750                                       | 87    | CK2308         | CSK17          | SRC8           |
| SR 500 S (3GWS)         | 98    | CK2296         | CSK14          |                | FZR 750 R OWO1                                | 89-90 | CK2318         | CSK17          | SRC9           |
| SR 500 (3GW1/4/6/7)     | 96-98 | CK2296         | CSK14          |                | XJ 750  | 82-83 | CK2255         | CSK14          |                |
| WR 500 ZD               | 92-93 | CK2280         | CSK2           |                | XJ 750 RF/RJ/RK 'Seca'                        | 81-83 | CK2255         | CSK14          |                |
| TT 500 G/H              | 80-81 | CK2296         | CSK14          |                | XS 750  | 77-79 | CK2279         | CSK14          |                |
| XT 500 C                | 76    | CK2334         | CSK14          |                | XS 750 SE                                     | 79-80 | CK2279         | CSK14          |                |
| XT 500                  | 77-81 | CK2296         | CSK14          |                | XTZ 750                                       | 89-95 | CK2255         | CSK17          |                |
| RD 500 LC               | 84-86 | CK2305         | CSK14          |                | XV 750 SE                                     | 81    | CK2274         | CSK81          |                |
| SR 500                  | 78-82 | CK2296         | CSK14          |                | XV 750 Virago                                 | 92-97 | CK2274         | CSK81          |                |
| XS 500 B                | 77    | CK2255         | CSK14          |                | YZF 750 R/SP                                  | 93-97 | CK2318         | CSK17          | SRC9           |
| XS 500 C/D              | 78-79 | CK2255         | CSK14          |                | YZF 7R OWO2                                   | 99-00 | CK2353         | N/A            |                |
| XV 535/535 S Virago     | 88-03 | CK2299         | CSK91          |                | TDM 850                                       | 91-95 | CK2255         | CSK17          |                |
| XJ 550                  | 81    | CK2306         | CSK14          |                | TDM 850                                       | 96-01 | CK2318         | CSK17          | SRC9           |
| XJ 550 H/J/K 'Maxim'    | 81-83 | CK2306         | CSK14          |                | TRX 850                                       | 96-98 | CK2318         | CSK17          | SRC9           |
| XJ 550 RH/RJ/RK 'Seca'  | 81-83 | CK2306         | CSK14          |                | XS 850  | 80    | CK2273         | CSK14          |                |
| XT 550                  | 82    | CK2310         | CSK14          |                | TDM 900 P/R/S/TV                              | 02-06 | CK2318         | CSK37          |                |
| XT 550                  | 83    | CK2297         | CSK14          | SRC72          | TDM 900 AT/AV/AW (ABS)                        | 05-07 | CK2318         | CSK37          |                |
| XZ 550                  | 82    | CK2296         | CSK14          |                | XJ 900  | 83/90 | CK2255         | CSK49          |                |
| FZ 600                  | 87-88 | CK2255         | CSK14          |                | XJ 900 F                                      | 85-92 | CK2255         | CSK17          |                |
| FZR 600                 | 89-93 | CK2315         | CSK42          | SRC7           | XJ 900 S Diversion                            | 95-03 | CK2255         | CSK17          |                |
| FZR 600 R (4JH1/4)      | 94-95 | CK2332         | CSK81          |                | FZ1-N/NV (Naked) (1000cc) (2D11/2/3)          | 06-07 | CK2356         | CSK119         | SRC77          |
| FZ 6 Fazer/Fazer A      | 04-07 | CK2255         | CSK17          | SRC51          | FZ-1 Fazer (1000cc)                           | 06-07 | CK2356         | CSK119         | SRC77          |
| FZ 6 Naked version      | 04-07 | CK2255         | CSK17          | SRC51          | FZR 1000                                      | 87-88 | CK2308         | CSK17          | SRC8           |
| FZ6 S2 ABS (Naked)      | 07    | CK2255         | CSK17          | SRC51          | FZR 1000                                      | 89-92 | CK2321         | CSK37          | SRC31          |
| FZ6 Fazer S2 (ABS)      | 07    | CK2255         | CSK17          | SRC51          | FZR 1000                                      | 93-95 | CK2327         | CSK37          | SRC29          |
| FZS 600 Fazer           | 98-99 | CK2347         | CSK2           |                | FZS 1000 Fazer                                | 01-05 | CK2358         | CSK37          |                |
| FZS 600 Fazer/"SP"      | 00-03 | CK2347         | CSK81          |                | GTS 1000                                      | 93-96 | CK2327         | CSK37          | SRC29          |
| SRX 600                 | 86-87 | CK2297         | CSK14          | SRC72          | XV 1000 TR1                                   | 81    | CK2274         | CSK14          |                |
| SRX 600 (1JK/3SX)       | 85-91 | CK2297         | CSK14          | SRC72          | XV 1000                                       | 86    | CK2274         | CSK14          |                |
| TT 600 L                | 84    | CK2297         | CSK2           |                | YZF 1000 Thunder Ace                          | 96-02 | CK2327         | CSK37          | SRC29          |
| TT 600 W (59X/2JT/3SU1) | 89-92 | CK2297         | CSK2           |                | YZF R1 (4XV1/2)                               | 98    | CK2226         | N/A            | SRC56          |
| TT 600 R (5CH2)         | 98-99 | CK2297         | CSK2           |                | YZF R1 (4XV7/8 5JJ1/8 5PW1/7)                 | 99-03 | CK2350         | N/A            | SRC65          |
| TT 600 R (5CH3)         | 00-02 | CK2297         | CSK2           |                | YZF R1  | 04-06 | CK2356         | CSK119         | SRC77          |
| TT 600 RE (5CH5)        | 04    | CK2296         | CSK2           |                | YZF R1SP                                      | 06    | CK2356         | CSK120         | SRC93          |
| TT 600 R (5CH1)         | 97    | CK2297         | CSK2           |                | YZF R1  | 07    | CK2356         | CSK120         | SRC93          |
| TT 600 E                | 94-01 | CK2297         | CSK2           |                | BT 1100 Bulldog P/R/S/TV                      | 02-06 | CK2274         | N/A            |                |
| TT 600 K                | 93-96 | CK2297         | CSK2           |                | XS 1100 /1100 S                               | 78-81 | CK2230         | CSK14          |                |
| XJ 600                  | 84-92 | CK2255         | CSK14          |                | XV 1100 Virago                                | 89-00 | CK2274         | N/A            |                |
| XJ 600 S Diversion      | 92-03 | CK2255         | CSK14          |                | XVS 1100 A Dragstar Classic                   | 00-07 | CK2274         | N/A            |                |
| XJ 600 N                | 95-03 | CK2255         | CSK14          |                | XVS 1100 Dragstar                             | 99-04 | CK2274         | N/A            |                |
| XT 600                  | 84-87 | CK2297         | CSK2           | DRC57          | FJ 1100                                       | 84-85 | CK2285         | N/A            |                |
| XT 600 Z                | 84-85 | CK2297         | CSK2           | DRC57          | FJ 1200/1200 A                                | 86-95 | CK2285         | N/A            |                |
| XT 600 Z                | 86-90 | CK2297         | CSK14          | DRC88          | XVZ 12 TD                                     | 85    | CK2300         | CSK46          |                |
| XT 600 E/ZE             | 90-03 | CK2297         | CSK14          | DRC88          | V-MAX 'All models'                            | 91-03 | CK2300         | N/A            |                |
| YX 600 S/SC/TC/UC/U/W   |       |                |                |                | XJR 1200                                      | 95-98 | CK2285         | N/A            |                |
| W/C/A/AC 'Radian'       | 86-90 | CK2255         | CSK14          |                | FJR 1300 N/P                                  | 01-02 | CK2362         | N/A            |                |
| YZF 600 'Thunder Cat'   | 96-03 | CK2332         | CSK102         | SRC33          | FJR 1300 R/AR/S/AS/AT (ABS)                   | 03-05 | CK2362         | N/A            |                |
| YZF 600 R "R6"          | 99-02 | CK2255         | CSK17          | SRC51          | FJR 1300 AV/ASV/AW/ASW (3P61/2/3) (ABS Model) | 06-07 | CK2362         | N/A            |                |
| YZF R6                  | 06    | CK2318         | CSK126         | SRC87          | FJR 1300 AS (2D21)                            | 06-07 | CK2362         | N/A            |                |
| YZF-R6                  | 03-05 | CK2255         | CSK92          | SRC74          | XJR 1300 L 5EA2/5EA3/5EA4                     | 99    | CK2285         | N/A            |                |
| YZF-R6S                 | 07    | CK2255         | CSK92          |                | XJR 1300 M 5EAA/5EAB/5EAC                     | 00    | CK2285         | N/A            |                |
| XJ 650                  | 80-84 | CK2255         | CSK81          |                | XJR 1300 (5EA1/5EA7)                          | 98-99 | CK2285         | N/A            |                |
| XJ 650 Turbo            | 82    | CK2255         | CSK14          |                | XJR 1300 (5EA9/5EAG)                          | 00    | CK2285         | N/A            |                |
| XJ 650 G/H/J/K 'Maxim'  | 80-83 | CK2255         | CSK81          |                | XJR 1300 N/P (5EAP/5EAS/5EAT                  |       |                |                |                |
| XJ 650 LH 'Midnight'    | 81    | CK2255         | CSK81          |                | /5EAW/5EAV/5EAY)                              | 01-02 | CK2285         | N/A            |                |
| XJ 650 RJ/LK Seca       | 82-83 | CK2255         | CSK14          |                | XJR 1300 R/S 5WMM3/5WMM5                      |       |                |                |                |
| XS 650                  | 75-76 | CK2226         | CSK14          |                | /5WMM6/5WMM7/5WMM9                            | 03-04 | CK2285         | N/A            |                |
| XS 650                  | 77-79 | CK2226         | CSK2           |                |   |       |                |                |                |
| XS 650                  | 80-81 | CK2242         | CSK14          |                |   |       |                |                |                |

CLUTCH APPLICATIONS

■ EP Kevlar Kit available, see page 310

# EBC CLUTCH KITS

| MAKE & MODEL                         | YEAR     | CLUTCH KIT NO. | SPRING KIT NO. | DRC/SRC SERIES | MAKE & MODEL                       | YEAR     | CLUTCH KIT NO. | SPRING KIT NO. | DRC/SRC SERIES |
|--------------------------------------|----------|----------------|----------------|----------------|------------------------------------|----------|----------------|----------------|----------------|
| <b>YAMAHA Cont..</b>                 |          |                |                |                | <b>BMW Cont..</b>                  |          |                |                |                |
| XJR 1300 T/V/W 5WMA/5WMC             |          |                |                |                | R 80 GS                            | 87-90    | CK6601         | N/A            |                |
| /5WMD/5WMF                           | 05-07    | CK2285         | N/A            |                | R 80 PD/CH                         | 90       | CK6601         | N/A            |                |
| XJR 1300 SP (L) (5EA5/5EA6/5EA8) 99  |          | CK2285         | N/A            |                | R 100 MYS                          | 93-96    | CK6601         | N/A            |                |
| XJR 1300 SP (M) (5EAD/5EAE/5EAF)00   |          | CK2285         | N/A            |                | R 100 R                            | 91-95    | CK6601         | N/A            |                |
| XJR 1300 SP (N) (5EAL/5EAM/5EAN)01   |          | CK2285         | N/A            |                | R 80 MYS                           | 94-95    | CK6601         | N/A            |                |
| XVZ 13 Royal Star 'All models' 96-01 |          | CK2300         | N/A            |                | R 80 R                             | 91-94    | CK6601         | N/A            |                |
| XVS 1300 A Midnight Star             | 07       | CK2362         | N/A            |                | R 80 GS                            | 96       | CK6601         | N/A            |                |
| XV 1600 A Wild Star                  | 99-04    | CK2351         | N/A            |                | R 45                               | 78-09/80 | CK6602         | N/A            |                |
| MT-01 (1670cc)                       | 05-07    | CK2366         | N/A            |                | R 45 N                             | 78-09/80 | CK6602         | N/A            |                |
| MT-03                                | 06-07    | CK2368         | CSK123         |                | R 65                               | 78-09/80 | CK6602         | N/A            |                |
| XV 1700 PCR Road Star Warrior        | 03-05    | CK2363         | N/A            |                | R 50/5                             | 69-73    | CK6603         | N/A            |                |
| XV 1900 A Midnight Star              | 06-07    | CK2367         | N/A            |                | R 60/5                             | 69-73    | CK6603         | N/A            |                |
|                                      |          |                |                |                | R 60/6                             | 73-76    | CK6603         | N/A            |                |
|                                      |          |                |                |                | R 75/5                             | 69-73/80 | CK6603         | N/A            |                |
| <b>APRILIA</b>                       |          |                |                |                |                                    |          |                |                |                |
| AF1 125                              | 87-91    | CK5598         | CSK2           |                | R 75/6                             | 73-76    | CK6603         | N/A            |                |
| Classic 125                          | 95-01    | CK5598         | CSK2           |                | R 90/6                             | 73-79    | CK6603         | N/A            |                |
| MX 125                               | 04-06    | CK5598         | CSK2           |                | R 90 S                             | 73-76    | CK6603         | N/A            |                |
| Pegaso 125                           | 91-95    | CK5598         | CSK2           |                | R 60/7                             | 76-09/80 | CK6603         | N/A            |                |
| Red Rose 125 (Cast Wheel)            | 87       | CK5598         | CSK2           |                | R 60 TIC                           | 78-09/80 | CK6603         | N/A            |                |
| Red Rose 125 (Spoke Wheel)           | 88-94    | CK5598         | CSK2           |                | R 75/7                             | 76-79    | CK6603         | N/A            |                |
| RS 125                               | 92-07    | CK5598         | CSK2           |                | R 80                               | 77-09/80 | CK6603         | N/A            |                |
| RX 125                               | 92-98    | CK5598         | CSK2           |                | R 80 TIC                           | 78-09/80 | CK6603         | N/A            |                |
| Tuono 125                            | 03-04    | CK5598         | CSK2           |                | R 100                              | 76-77    | CK6603         | N/A            |                |
| RS 250                               | 95-02    | CK3333         | CSK7           |                | R 100/7T                           | 77-09/80 | CK6603         | N/A            |                |
| Pegaso Strada/Trial                  | 05-06    | CK2368         | CSK123         |                | R 100 RS                           | 76-09/80 | CK6603         | N/A            |                |
| RSV 1000 (All models)                | 99-07    | CK6680         | CSK200         |                | R 100 RT                           | 78-09/80 | CK6603         | N/A            |                |
| SL 1000 Falco                        | 00-04    | CK6680         | CSK200         |                | R 100 S                            | 76-80    | CK6603         | N/A            |                |
| ETV 1000 Caponord                    | 01-07    | CK6680         | CSK200         |                | K 75                               | 84-96    | CK6604         | N/A            |                |
| RST Futura 1000                      | 01-04    | CK6680         | CSK200         |                | K 75/2                             | 84-96    | CK6604         | N/A            |                |
|                                      |          |                |                |                | K 75 C                             | 85-88    | CK6604         | N/A            |                |
|                                      |          |                |                |                | K 75 RT                            | 89-96    | CK6604         | N/A            |                |
| <b>BMW</b>                           |          |                |                |                |                                    |          |                |                |                |
| R 45/R 45 N                          | 81-      | CK6601         | N/A            |                | K 75 S                             | 85-95    | CK6604         | N/A            |                |
| R 65 All models                      | 81-      | CK6601         | N/A            |                | K 100                              | 82-88    | CK6605         | N/A            |                |
| R 80 All models                      | 80-      | CK6601         | N/A            |                | K 100/2                            | 87-90    | CK6605         | N/A            |                |
| R 100 All models                     | 80-      | CK6601         | N/A            |                | K 100 LT                           | 86-91    | CK6605         | N/A            |                |
| R 45/R 45 N                          | 78-80    | CK6602         | N/A            |                | K 100 RT                           | 83-89    | CK6605         | N/A            |                |
| R 65                                 | 78-80    | CK6602         | N/A            |                | K1                                 | 88-93    | CK6605         | N/A            |                |
| R 50/5                               | 69-72    | CK6603         | N/A            |                | K 100 RS                           | 89-92    | CK6605         | N/A            |                |
| R 60/5-7                             | 69-80    | CK6603         | N/A            |                | K 1100 LT                          | 89-99    | CK6605         | N/A            |                |
| R 75 All models                      | 69-      | CK6603         | N/A            |                | K 1100 RS                          | 92-96    | CK6605         | N/A            |                |
| R 80/7 N-S                           | 77-80    | CK6603         | N/A            |                | F 650/93 K60/0161                  | 93-06/94 | CK5605         | CSK104         |                |
| R 90/6, S                            | 73-76    | CK6603         | N/A            |                | F 650/93 K60/0161                  | 07/94-96 | CK5605         | CSK104         |                |
| R 100/7 T, S, RT, RS                 | 76-80    | CK6603         | N/A            |                | F 650/97 K60/0162                  | 96-03    | CK5605         | CSK104         |                |
| K 75 All models                      | 85-      | CK6604         | N/A            |                | F 650 ST K60/0163                  | 96-00    | CK5605         | CSK104         |                |
| K 100 All models                     | 83-      | CK6605         | N/A            |                | F 650 Dakar/M K78/0176             | 03-05    | CK5635         | CSK104         |                |
| K1                                   | 89-      | CK6605         | N/A            |                | F 650 Dakar K78/0173               | 99-03    | CK5636         | CSK104         |                |
| R 100 RS                             | 86-92    | CK6601         | N/A            |                | F 650 GS K78/0172                  | 99-03    | CK5636         | CSK104         |                |
| R 100 RT                             | 87-95    | CK6601         | N/A            |                | F 650 GS/M K78/0175                | 03-07    | CK5635         | CSK104         |                |
| R 45                                 | 09/80-85 | CK6601         | N/A            |                | F 650 CS Scarver K14/0174          | 00-03    | CK5636         | CSK104         |                |
| R 45/N                               | 09/80-85 | CK6601         | N/A            |                | F 650 CS/M Scarver K14/0177        | 03-06    | CK5635         | CSK104         |                |
| R 45 T                               | 09/80-85 | CK6601         | N/A            |                |                                    |          |                |                |                |
| R 45 T/N                             | 09/80-85 | CK6601         | N/A            |                | <b>CCM</b>                         |          |                |                |                |
| R 65                                 | 09/80-85 | CK6601         | N/A            |                | R30 (644 Suzuki Engine)            | 02-04    | CK3386         | CSK4           | DRC87          |
| R 65 LS                              | 81-85    | CK6601         | N/A            |                | R35/R35S                           | 06-07    | CK3433         | CSK79          | DRC105         |
| R 65 T                               | 80-85    | CK6601         | N/A            |                | 404 E/DS/Supermoto                 | 03-04    | CK3433         | CSK79          | DRC105         |
| R 65 GS                              | 87-92    | CK6601         | N/A            |                | 604 Trial/SM/RS/R30 (Rotax Engine) | 98-03    | CK5628         | CSK127         | DRC165         |
| R 80 GS                              | 80-87    | CK6601         | N/A            |                | 644 DS/Supermoto                   | 04       | CK3386         | CSK4           | DRC87          |
| R 80 ST                              | 82-84    | CK6601         | N/A            |                | CR 40 S Cafe Racer                 | 07       | CK3433         | CSK79          | DRC105         |
| R 80                                 | 09/80-84 | CK6601         | N/A            |                | CR 40 Street                       | 07       | CK3433         | CSK79          | DRC105         |
| R 80 RT                              | 82-84    | CK6601         | N/A            |                | SR 40 Street Scrambler             | 07       | CK3433         |                |                |
| R 80 TIC                             | 09/80-85 | CK6601         | N/A            |                |                                    |          |                |                |                |
| R 100/7 T                            | 09/80-84 | CK6601         | N/A            |                | <b>DERBI</b>                       |          |                |                |                |
| R 100 CS                             | 80-84    | CK6601         | N/A            |                | Mulhacen 659                       | 06-07    | CK2297         | CSK14          |                |
| R 100 RS                             | 09/80-84 | CK6601         | N/A            |                |                                    |          |                |                |                |
| R 100 RT                             | 09/80-84 | CK6601         | N/A            |                | <b>ELSTARS (Pit bikes)</b>         |          |                |                |                |
| R 100 TIC                            | 80-84    | CK6601         | N/A            |                | Various models                     |          |                |                |                |
| R 65/20                              | 85-93    | CK6601         | N/A            |                | (Check parts before fitting)       |          | CK1308         | N/A            | SRC91          |
| R 65/35                              | 85-88    | CK6601         | N/A            |                |                                    |          |                |                |                |
| R 65 RT                              | 85-88    | CK6601         | N/A            |                | <b>KTM</b>                         |          |                |                |                |
| R 80                                 | 84-95    | CK6601         | N/A            |                | SXR 50 Pro Senior/Junior           | 97-99    | N/A            | N/A            | N/A            |
| R 80 RT                              | 84-95    | CK6601         | N/A            |                | 50 Mini Adventure/Junior/Senior    | 97-07    | N/A            | N/A            | N/A            |
| R 100 GS                             | 86-90    | CK6601         | N/A            |                | SX 50 Junior/Senior/LC             | 00-07    | N/A            | N/A            | N/A            |
| R 100 PD                             | 89-90    | CK6601         | N/A            |                | SX 60                              | 98-00    | CK5594         | CSK64          | DRC107         |

CLUTCH APPLICATIONS

# EBC CLUTCH KITS

| MAKE & MODEL       | YEAR     | CLUTCH KIT NO. | SPRING KIT NO. | DRC/SRC SERIES | MAKE & MODEL          | YEAR  | CLUTCH KIT NO. | SPRING KIT NO. | DRC/SRC SERIES |
|--------------------|----------|----------------|----------------|----------------|-----------------------|-------|----------------|----------------|----------------|
| <b>KTM Cont..</b>  |          |                |                |                | <b>KTM Cont..</b>     |       |                |                |                |
| SX 65              | 98-07    | CK5594         | CSK64          | DRC107         | SXC 400               | 97    | CK5631         | CSK129         | DRC170         |
| SX 85              | 03-07    | CK5610         | CSK42          | DRC139         | 400 SX-X              | 98    | CK5631         | CSK129         | DRC170         |
| SX 105             | 04-07    | CK5610         | CSK42          | DRC139         | 400 SX                | 99    | CK5631         | CSK129         | DRC170         |
| 125 EGS            | 94-97    | CK6606         | CSK11          | DRC157         | SX 400                | 00-01 | CK5602         | CSK120         | DRC117         |
| 125 EGS            | 98-99    | CK5611         | CSK24          | DRC145         | 400 SX Racing         | 02    | CK5612         | CSK120         | DRC171         |
| 125 EXC            | 94-97    | CK6606         | CSK11          | DRC157         | 400 SXC               | 00    | CK5631         | CSK129         | DRC170         |
| 125 EXC            | 98-05    | CK5611         | CSK24          | DRC145         | 400 TXC               | 98    | CK5631         | CSK129         | DRC170         |
| 125 EXE            | 00-01    | CK5611         | CSK24          | DRC145         | SX 440                | 94    | N/A            | N/A            | N/A            |
| 125 LC 2 Sting     | 96-98    | N/A            | N/A            | N/A            | MXC 440               | 94    | N/A            | N/A            | N/A            |
| 125 Six Days       | 96       | CK6606         | CSK11          | DRC157         | EXC 440               | 94-95 | N/A            | N/A            | N/A            |
| 125 Supermoto      | 00-01    | CK5611         | CSK24          | DRC145         | 450 EXC Racing        | 03    | CK5612         | CSK120         | DRC171         |
| SX 125             | 94-97    | CK6606         | CSK11          | DRC157         | 450 EXC-G Racing      | 03    | CK5612         | CSK120         | DRC171         |
| SX 125             | 98-06    | CK5611         | CSK24          | DRC145         | 450 EXC-G Racing      | 04    | CK5602         | CSK120         | DRC117         |
| SX 125             | 07       | CK5611         | CSK132         | DRC174         | 450 EXC-G Racing      | 05    | CK5612         | CSK120         | DRC154         |
| 125 SXS            | 01-02    | CK5611         | CSK24          | DRC145         | 450 EXC Racing        | 04    | CK5602         | CSK120         | DRC117         |
| 200 EGS            | 98-99    | CK5611         | CSK91          | DRC144         | 450 EXC Racing        | 05    | CK5612         | CSK120         | DRC154         |
| 200 EXC            | 97-07    | CK5611         | CSK91          | DRC144         | 450 EXC               | 06-07 | CK5612         | CSK120         | DRC171         |
| 200 MXC            | 98-03    | CK5611         | CSK91          | DRC144         | 450 MXC-G Racing      | 03    | CK5612         | CSK120         | DRC171         |
| SX 200             | 03/06-07 | CK5611         | CSK91          | DRC144         | 450 MXC-G Racing      | 04    | CK5602         | CSK120         | DRC117         |
| SX 250             | 94-07    | CK5595         | CSK80          | DRC108         | 450 MXC-G Racing      | 05    | CK5612         | CSK120         | DRC154         |
| SX-F 250           | 05-07    | CK1293         | CSK77          | DRC163         | MXC 450               | 06    | CK5612         | CSK120         | DRC171         |
| 250 EGS            | 94-99    | CK5595         | CSK80          | DRC108         | 450 SMR               | 04-05 | CK5612         | CSK120         | DRC154         |
| 250 EXC            | 94-07    | CK5595         | CSK80          | DRC108         | SMR 450               | 06-07 | CK5612         | CSK120         | DRC171         |
| 250 EXC-G Racing   | 03       | CK5612         | CSK120         | DRC171         | 450 SMS               | 04    | CK5612         | CSK120         | DRC172         |
| 250 MXC            | 98-99    | CK5595         | CSK80          | DRC108         | 450 SX Racing         | 03    | CK5612         | CSK120         | DRC171         |
| 250 SXS            | 01-03    | CK5595         | CSK80          | DRC108         | 450 SX Racing         | 04    | CK5602         | CSK120         | DRC117         |
| 250 EXC Racing     | 02-03    | CK5612         | CSK120         | DRC171         | 450 SX Racing         | 05    | CK5612         | CSK120         | DRC154         |
| 250 EXC Racing     | 04       | CK5602         | CSK120         | DRC117         | SX 450                | 06    | CK5612         | CSK120         | DRC171         |
| 250 EXC Racing     | 05       | CK5612         | CSK120         | DRC154         | SX-F 505              | 07    | TBA            | TBA            |                |
| 250 EXC-G Racing   | 04       | CK5602         | CSK120         | DRC117         | 520 EXC               | 00-01 | CK5602         | CSK120         | DRC117         |
| EXC-F 250          | 06-07    | CK1293         | CSK77          | DRC163         | SX 520                | 00-01 | CK5602         | CSK120         | DRC117         |
| 300 EGS            | 94-99    | CK5595         | CSK80          | DRC108         | 520 SX Racing         | 02    | CK5612         | CSK120         | DRC171         |
| 300 EXC            | 94-07    | CK5595         | CSK80          | DRC108         | 525 EXC-G Racing      | 03    | CK5612         | CSK120         | DRC171         |
| 300 MXC            | 94-03    | CK5595         | CSK80          | DRC108         | 525 EXC               | 03    | CK5612         | CSK120         | DRC171         |
| 300 MXC            | 04-05    | CK5595         | CSK80          | DRC108         | 525 EXC Racing        | 04    | CK5602         | CSK120         | DRC117         |
| SX 300             | 94       | CK5595         | CSK80          | DRC108         | 525 EXC-G Racing      | 04    | CK5602         | CSK120         | DRC117         |
| 300 Six Days       | 96       | CK5595         | CSK80          | DRC108         | 525 EXC Racing        | 05    | CK5612         | CSK120         | DRC154         |
| 350 EXC            | 94       | CK5631         | CSK80          | DRC169         | 525 EXC-G Racing      | 05    | CK5612         | CSK120         | DRC154         |
| 350 Super Comp     | 94-95    | CK5631         | CSK80          | DRC169         | 525 MXC Desert Racing | 03    | CK5612         | CSK120         | DRC171         |
| 360 EGS            | 96-97    | CK5595         | CSK80          | DRC108         | 525 MXC Desert Racing | 04    | CK5602         | CSK120         | DRC117         |
| 360 EXC            | 96-97    | CK5595         | CSK80          | DRC108         | 525 MXC Desert Racing | 05    | CK5612         | CSK120         | DRC154         |
| 360 MXC            | 96-97    | CK5595         | CSK80          | DRC108         | MXC 525               | 06    | CK5612         | CSK120         | DRC171         |
| 360 SX             | 96-97    | CK5595         | CSK80          | DRC108         | 525 MXC-G Racing      | 04    | CK5602         | CSK120         | DRC117         |
| 360 Six Days       | 96       | CK5595         | CSK80          | DRC108         | 525 SMR               | 04-05 | CK5612         | CSK120         | DRC154         |
| 380 EGS            | 98-99    | CK5631         | CSK129         | DRC170         | 525 SX Racing         | 03    | CK5612         | CSK120         | DRC171         |
| 380 EXC            | 98-02    | CK5595         | CSK80          | DRC108         | 525 SX Racing         | 04    | CK5602         | CSK120         | DRC117         |
| 380 MXC            | 98-01    | CK5595         | CSK80          | DRC108         | 525 SX Racing         | 05    | CK5602         | CSK120         | DRC154         |
| SX 380             | 98-02    | CK5595         | CSK80          | DRC108         | SX 525                | 06    | CK5612         | CSK120         | DRC171         |
| 400 Duke           | 94-95    | CK5631         | CSK80          | DRC169         | 540 SX-C              | 98-99 | CK5631         | CSK129         | DRC170         |
| 400 EGS-E          | 97       | CK5631         | CSK129         | DRC170         | 540 SXS Racing        | 02    | CK5612         | CSK120         | DRC171         |
| 400 EGS            | 94       | CK5631         | CSK80          | DRC169         | MXC 550               | 94-96 | N/A            | N/A            | N/A            |
| 400 EGS            | 96-97    | CK5631         | CSK129         | DRC170         | SMR 560               | 06-07 | CK5612         | CSK120         | DRC171         |
| 400 EXC            | 94       | CK5631         | CSK80          | DRC169         | 620 Duke              | 94    | CK5631         | CSK80          | DRC169         |
| 400 EXC            | 96       | CK5631         | CSK129         | DRC170         | 620 Duke              | 97    | CK5631         | CSK129         | DRC170         |
| 400 EXC            | 00-01    | CK5602         | CSK120         | DRC117         | 620 EGS               | 94-95 | CK5631         | CSK80          | DRC169         |
| 400 EXC Racing     | 02       | CK5612         | CSK120         | DRC171         | 620 EGS/Adventure     | 96-97 | CK5631         | CSK129         | DRC170         |
| 400 EXC-G Racing   | 02       | CK5612         | CSK120         | DRC171         | 620 EGS-E             | 97    | CK5631         | CSK129         | DRC170         |
| 400 EXC Racing     | 05       | CK5612         | CSK120         | DRC154         | 620 Enduro Ltd        | 97    | CK5631         | CSK129         | DRC170         |
| 400 EXC            | 07       | CK5612         | CSK120         | DRC171         | 620 EXC               | 94-95 | CK5631         | CSK80          | DRC169         |
| 400 EXC-G Racing   | 05       | CK5612         | CSK120         | DRC154         | 620 LC-4              | 98    | CK5631         | CSK129         | DRC170         |
| 400 EXC-G Racing   | 06       | CK5612         | CSK120         | DRC171         | 620 LC4 Competition   | 99    | CK5631         | CSK129         | DRC170         |
| 400 LC-4           | 98       | CK5631         | CSK129         | DRC170         | 620 LC4 Super Moto    | 99    | CK5631         | CSK129         | DRC170         |
| 400 LC4-E          | 00-01    | CK5631         | CSK129         | DRC170         | 620 LSE               | 97    | CK5631         | CSK129         | DRC170         |
| LC4 R 400          | 99       | CK5631         | CSK129         | DRC170         | 620 RXC-E             | 96-97 | CK5631         | CSK129         | DRC170         |
| 400 LSE            | 97       | CK5631         | CSK129         | DRC170         | 620 Six Days          | 96    | CK5631         | CSK129         | DRC170         |
| 400 LS-E           | 04       | CK5631         | CSK129         | DRC170         | 620 Super Comp        | 94-95 | CK5631         | CSK80          | DRC169         |
| 400 MXC            | 01       | CK5602         | CSK120         | DRC117         | 620 Super Comp        | 96-99 | CK5631         | CSK129         | DRC170         |
| 400 MXC            | 02       | CK5612         | CSK120         | DRC171         | RXC-E 620             | 95    | CK5595         | CSK11          | DRC108         |
| 400 Super Comp     | 95       | CK5631         | CSK80          | DRC169         | 620 RXC-E             | 95    | CK5632         | CSK11          | DRC178         |
| 400 Super Comp/EXC | 96-99    | CK5631         | CSK129         | DRC170         | 620 SC                | 00-01 | CK5631         | CSK129         | DRC170         |
| RXC-E 400          | 95       | CK5595         | CSK11          | DRC108         | SX 620                | 94    | CK5631         | CSK80          | DRC169         |
| 400 RXC-E          | 95       | CK5632         | CSK11          | DRC178         | SX 620                | 97-99 | CK5631         | CSK129         | DRC170         |
| 400 RXC-E          | 96-97    | CK5631         | CSK129         | DRC170         | SXC 620               | 97    | CK5631         | CSK129         | DRC170         |

CLUTCH APPLICATIONS

# EBC CLUTCH KITS

| MAKE & MODEL                        | YEAR  | CLUTCH KIT NO. | SPRING KIT NO. | DRC/SRC SERIES | MAKE & MODEL                   | YEAR  | CLUTCH KIT NO. | SPRING KIT NO. | DRC/SRC SERIES |
|-------------------------------------|-------|----------------|----------------|----------------|--------------------------------|-------|----------------|----------------|----------------|
| <b>KTM Cont..</b>                   |       |                |                |                | <b>TRIUMPH Cont..</b>          |       |                |                |                |
| 620 Supermoto                       | 98    | CK5631         | CSK129         | DRC170         | Speedtriple 955cc (From VIN    |       |                |                |                |
| 620 TXC                             | 98    | CK5631         | CSK129         | DRC170         | 141872 to 210444)              | 02-04 | CK5599         | CSK29          |                |
| 625 SC                              | 02    | CK5631         | CSK129         | DRC170         | Daytona 900 93cyl)             | 93-96 | CK5588         | CSK68          |                |
| 625 SMC                             | 04/06 | CK5631         | CSK129         | DRC170         | Thrupton 900                   | 04-07 | CK5608         | CSK15          |                |
| 625 SXC                             | 03-04 | CK5631         | CSK129         | DRC170         | Tiger 900cc (Up to VIN71698)   | 93-96 | CK5588         | CSK68          |                |
| 640 Adventure-R                     | 98-02 | CK5631         | CSK129         | DRC170         | Tiger 900cc (From VIN71699)    | 97-98 | CK5589         | CSK29          |                |
| 640 Duke-E                          | 98    | CK5631         | CSK129         | DRC170         | Trident 900                    | 92-98 | CK5588         | CSK68          |                |
| 640 Duke II                         | 99-04 | CK5631         | CSK129         | DRC170         | Trophy 900 (3cyl)              | 92-01 | CK5588         | CSK68          |                |
| 640 LC Rallye Dakar                 | 97    | CK5631         | CSK129         | DRC170         | Daytona 955i                   | 98-00 | CK5589         | CSK29          |                |
| 640 LC4                             | 99    | CK5631         | CSK129         | DRC170         | Daytona 955i (From VIN 132513) | 01-06 | CK5599         | CSK29          |                |
| 640 LC4                             | 99-00 | CK5631         | CSK129         | DRC170         | Tiger 955cc (Up to VIN 198874) | 99-04 | CK5589         | CSK29          |                |
| 640 LC4 Six Days                    | 99    | CK5631         | CSK129         | DRC170         | Tiger 955 (From VIN 198875)    | 04-06 | CK5589         | CSK29          |                |
| 640 LC4-E                           | 00-02 | CK5631         | CSK129         | DRC170         | Daytona 1000 (4cyl)            | 92    | CK5588         | CSK15          |                |
| 640 LC4 Adventure                   | 03-06 | CK5631         | CSK129         | DRC170         | Speed Triple (1050cc)          | 05-07 | CK5599         | CSK29          |                |
| 640 LC4 Supermoto                   | 03-04 | CK5631         | CSK129         | DRC170         | Sprint ST (1050cc) (From VIN   |       |                |                |                |
| 660 LC4                             | 97    | CK5631         | CSK129         | DRC170         | 208167)                        | 05-07 | CK5599         | CSK29          |                |
| 660 LC4 Rallye                      | 99-00 | CK5631         | CSK131         | DRC175         | Daytona Super III (3cyl)       | 94-97 | CK5588         | CSK68          |                |
| 660 Rallye                          | 01-03 | CK5633         | CSK129         | DRC176         | Daytona 1200 (4cyl)            | 93-98 | CK5588         | CSK45          |                |
| 660 Rallye factory                  | 04    | CK5633         | CSK129         | DRC176         | Legend TT                      | 98-01 | CK5588         | CSK68          |                |
| 660 SM Factory Replica              | 02-03 | CK5631         | CSK131         | DRC175         | Rocket III 2300cc              | 04-07 | CK5624         | CSK118         |                |
| 660 SMC                             | 03-04 | CK5631         | CSK131         | DRC175         | Sprint (All carb models        |       |                |                |                |
| 660 SMS                             | 04    | CK5631         | CSK131         | DRC175         | up to VIN9082)                 | 93    | CK5588         | CSK68          |                |
| 690 SM/SM Prestige                  | 07    | TBA            | TBA            |                | Sprint (All carb models        |       |                |                |                |
| 950 Adventure S                     | 03-04 | CK5634         | CSK130         | DRC177         | from VIN9083)                  | 94-98 | CK5588         | CSK68          |                |
| 950 Adventure                       | 06    | CK5634         | CSK130         | DRC177         | Sprint RS (Up to VIN139276)    | 99-01 | CK5589         | CSK29          |                |
| 990 Superduke                       | 06    | CK5634         | CSK130         | DRC158         | Sprint RS (From VIN 139277)    | 02-04 | CK5599         | CSK29          |                |
| 950 Superenduro R                   | 07    | CK5634         | CSK130         | DRC177         | Sprint ST (Up to VIN 139276)   | 99-01 | CK5589         | CSK29          |                |
|                                     |       |                |                |                | Sprint ST (From VIN139277 to   |       |                |                |                |
| <b>MODENAS</b>                      |       |                |                |                |                                |       |                |                |                |
| Kriss 110/115                       |       | CK4438         | CSK40          |                | 208166)                        | 02-04 | CK5599         | CSK29          |                |
|                                     |       |                |                |                | Thunderbird                    | 95-03 | CK5588         | CSK68          |                |
| <b>MOTO ROMA</b>                    |       |                |                |                |                                |       |                |                |                |
| Geko 300 Quad                       | 04-06 | CK1190         | N/A            |                | Thunderbird Sport              | 98-04 | CK5588         | CSK68          |                |
|                                     |       |                |                |                | Trophy 1200 (4cyl)             | 92-01 | CK5588         | CSK15          |                |
| <b>QUADZILLA</b>                    |       |                |                |                |                                |       |                |                |                |
| WK 300                              | 06    | CK3399         | CSK34          | DRC58          |                                |       |                |                |                |
| <b>SACHS</b>                        |       |                |                |                |                                |       |                |                |                |
| XTC 125                             | 00-07 | CK3318         | CSK34          |                |                                |       |                |                |                |
| X Road 125                          | 06-07 | CK3318         | CSK34          |                |                                |       |                |                |                |
| <b>TRIUMPH</b>                      |       |                |                |                |                                |       |                |                |                |
| Adventurer                          | 96-01 | CK5588         | CSK68          |                |                                |       |                |                |                |
| America (cast wheel)                | 07    | CK5608         | CSK15          |                |                                |       |                |                |                |
| Bonneville America                  | 02-06 | CK5608         | CSK15          |                |                                |       |                |                |                |
| Bonneville/Bonneville Black (865cc) | 07    | CK5608         | CSK15          |                |                                |       |                |                |                |
| T595 Daytona                        | 97    | CK5589         | CSK29          |                |                                |       |                |                |                |
| Daytona 600                         | 03-04 | CK1206         | CSK83          |                |                                |       |                |                |                |
| Speedfour 600 Up to VIN 210261      | 02-05 | CK1206         | CSK83          |                |                                |       |                |                |                |
| Speedfour From VIN 210262           | 02-05 | CK1181         | CSK15          |                |                                |       |                |                |                |
| TT600                               | 00-03 | CK1206         | CSK83          |                |                                |       |                |                |                |
| Daytona 650                         | 05    | CK1181         | CSK15          |                |                                |       |                |                |                |
| Daytona 675                         | 06-07 | CK1206         | CSK135         |                |                                |       |                |                |                |
| Daytona 750 (3cyl)                  | 92    | CK5588         | CSK68          |                |                                |       |                |                |                |
| Trident 750                         | 92-98 | CK5588         | CSK68          |                |                                |       |                |                |                |
| Bonneville 800 (790cc)              |       |                |                |                |                                |       |                |                |                |
| Up to Engine no. 211132             | 01-04 | CK5597         | CSK15          |                |                                |       |                |                |                |
| Bonneville 800                      |       |                |                |                |                                |       |                |                |                |
| From Engine no. 211133              | 01-04 | CK5608         | CSK15          |                |                                |       |                |                |                |
| Rocket III Classic                  | 07    | CK5624         | CSK118         |                |                                |       |                |                |                |
| Speedmaster 800 (790cc)             |       |                |                |                |                                |       |                |                |                |
| Up to VIN 210261                    | 03-04 | CK5608         | CSK15          |                |                                |       |                |                |                |
| Speedmaster From VIN 210262         | 03-04 | CK5608         | CSK15          |                |                                |       |                |                |                |
| Scrambler (865cc)                   | 06-07 | CK5608         | CSK15          |                |                                |       |                |                |                |
| Speedmaster (865cc)                 | 05-07 | CK5608         | CSK15          |                |                                |       |                |                |                |
| Bonneville T-100 (790cc)            |       |                |                |                |                                |       |                |                |                |
| Up to Engine no. 211132             | 02-04 | CK5597         | CSK15          |                |                                |       |                |                |                |
| Bonneville T-100                    |       |                |                |                |                                |       |                |                |                |
| From Engine No. 211133              | 02-04 | CK5608         | CSK15          |                |                                |       |                |                |                |
| Bonneville T100 (865cc)             | 05-07 | CK5608         | CSK15          |                |                                |       |                |                |                |
| Speed Triple (Carb models)          | 94-97 | CK5588         | CSK68          |                |                                |       |                |                |                |
| Speed Triple (EFI)                  | 97-01 | CK5589         | CSK29          |                |                                |       |                |                |                |

CLUTCH APPLICATIONS

# CLUTCH KIT BUYERS GUIDE

|        |  |  |                  |  |   |  |
|--------|--|--|------------------|--|---|--|
| CK1101 | <b>HONDA</b><br>No fitment   |  | CK1119<br>Contd. | <b>HONDA Cont.</b><br>TRX 250 EX1/EX2<br>TRX 250 EX1/2/3/4/5/6/7<br><b>HONDA-DALL'ARA</b><br>XR 125 SM<br><b>KAWASAKI</b><br>KLF 185 A3                    | 01-02<br>01-07<br>04<br>87                                  |  |
| CK1102 | No fitment   |  | CK1120           | <b>HONDA</b><br>No fitment   |   |  |
| CK1103 | No fitment   |  | CK1121           | No fitment   |   |  |
| CK1104 | Use CK1276   |  | CK1122           | No fitment   |   |  |
| CK1105 | SS 50 ZK2/ZB2<br>CD 50 ST/SV/SW/SX Benley 50 S<br>CL 50 V/X Benley CL 50   | 75-80<br>96-99<br>97-99  | CK1123           | No fitment   |   |  |
| CK1106 | Use CK1107   |  | CK1124           | No fitment   |   |  |
| CK1107 | Z50 RZ-RD<br>C 70/C70M   | 79-86<br>-78   | CK1125           | No fitment   |   |  |
| CK1108 | Use CK1156   |  | CK1126           | No fitment   |   |  |
| CK1109 | Use CK1105   |  | CK1127           | No fitment   |   |  |
| CK1110 | Use CK1107   |  | CK1128           | No fitment   |   |  |
| CK1111 | No fitment   |  | CK1129           | No fitment   |   |  |
| CK1112 | Use CK1107   |  | CK1130           | CB500 T  |   |  |
| CK1113 | Use CK1107   |  | CK1131           | CR 250 RB/RC<br>TL 250/TL250 K1<br>XL 250 K3/K4<br>CR 450 RB<br>CR 480 RC  | 81-82<br>78-79<br>78-79<br>81<br>82                         |  |
| CK1114 | Use CK1111   |  | CK1132           | CB 250 K3-K5/G5<br>CJ 250 T/T2<br>CB 350 K4<br>CB 360/CJ 360 (All models)  | 73-76<br>77   |  |
| CK1115 | No fitment   |  | CK1133           | CB 750/K1/K2/K3/K4/K5<br>(From E/No.:1056080)  | 69-75   |  |
| CK1116 | Use CK1156   |  | CK1134           | CB 175 (All models)<br>CD 175 (All models)<br>CB 200/CB 200 B  | 76-78   |  |
| CK1117 | Use CK1150   |  | CK1135           | CB 500/K1/K2   | 75-77   |  |
| CK1118 | Use CK1151   |  | CK1136           | Use CK1140   |   |  |
| CK1119 | CR 80 RE/RF/R2F/RG/R2G/RH/RJ<br>/RK/RL/RM/RP/RR/RS/RT/RBT<br>/RV/RBV/RW/RBW/RX/RBX/RY<br>/RBY/R1/RB1/R2/RB2<br>CR 85 R3/RB3/R4/RB4/R5/RB5/R6<br>/RB6/R7/RB7<br>CB 100 N<br>CB 125 S/J<br>CB 125 T/T2<br>CB 125 TDC/TDE<br>CB 125 RS<br>CD 125 TC<br>CG 125 K1/B/C/E/BR/BR-K/BR-J/S/T/W<br>CLR 125 W 'City Fly'<br>CM 125 CC/CF<br>CT125 C<br>TL125 S<br>NX 125 K/S/F Transcity<br>XL 125 K2-K4/SZ/SA<br>XL 125 SB/SC/SZ/SA/RC/RF/RH<br>XLR 125 RW<br>XR 125 L3/L4/L5/L6/L7<br>CRF 150 F6/F7<br>CD 185 T<br>XL 185 SZ/SA/SB<br>CD 200 TA<br>CM 200 TA/TB<br>CTX 200/CTX 200 A Bushlander<br>TL 200 J/Y<br>TLR 200 D/E/G/H<br>TRX 200 L/M/DM/DN<br>XR 200 RB/RC/RD<br>XR 200<br>XR 200 R<br>XR 200 R<br>TLR 250 F<br>TRX 250 V/W/X/Y/1/TE2-7/TM2-7 | 84-02<br>03-07<br>78-80<br>75-79<br>78-80<br>83-86<br>83<br>78<br>77-00<br>98-03<br>82-85<br>85<br>76<br>89-97<br>78-79<br>79-86<br>98-99<br>03-07<br>06-07<br>78<br>80-82<br>79-80<br>79-80<br>04-05<br>76-78<br>83-87<br>90-93<br>81-83<br>80-84<br>81-83<br>86-02<br>85-<br>97-07 |                  | CK1137   | Use CK1131  |  |
|        |  |  | CK1138           | No fitment   |   |  |
|        |  |  | CK1139           | Use CK1132   |   |  |
|        |  |  | CK1140           | CB 250 T/N/NA/NB/ND/NBD/NDC<br>CM 250 TB<br>CB 350 SG/SJ<br>CB 400 F/F1/F2<br>CB 400 T/N/NA/NB/NC<br>CMX 450 CH/CJ Rebel<br>XL 500 SZ/SB/RC<br>CB 450 DX-K | 78-82<br>81<br>86-88<br>75-79<br>78-82<br>02<br>80-82<br>89 |  |
|        |  |  | CK1141           | Use CK1146   |   |  |
|        |  |  | CK1142           | Use CK1145   |   |  |
|        |  |  | CK1143           | GL 1000 K1/K2 'Goldwing' (From E/No.:2002384)  | 77-78   |  |
|        |  |  | CK1144           | CR 125 M2-M4   | 76-78   |  |

| Part No. | Make/Model  | Year   | Part No. | Make/Model   | Year   |
|----------|---|--|----------|--|--|
| CK1145   | <b>HONDA Cont.</b><br>CB 750 F2<br>CB 750 K6/K7   | 78<br>76-77  | CK1152   | <b>HONDA Cont.</b><br>XL 250 S/SZ/SA<br>XR 250 SZ/SA   | 78-80<br>78-80   |
| CK1146   | CB 500 F/K3<br>CX 500 CA/CB/Z/A/B/EC<br>GL 500 DC<br>CB 550 F/F1/F2/K3  | 79-85<br>82<br>78-80   | CK1153   | NS 125 FG/FH/RH<br>CB 250 RSA/RSD<br>CL 250 SC<br>XL 250 RB/RC/RD<br>XL 250 SB/RC  | 86-90<br>81-84<br>81<br>81-83<br>81-82   |
| CK1147   | CB 650 Z/B/SCC<br>CX 650 ED<br>GL 650 D2-E  | 79-82<br>83-85<br>84   | CK1154   | TRX 420 FM7/TM7 Fourtrax Rancher<br>XR 500 SZ/SA/RB/RC<br>FT 500C  | 07<br>79-82<br>82  |
| CK1148   | C 50 Z2/ZZ/ZA<br>C 50 All Models<br>C 50 N (Single seat model)<br>C 50 P/S/V/X/Y/1/2<br>CF 50/CF 50 K2<br>CRF 50 F4/F5/F6/F7<br>MP 50 3/DX3 Solo (AC17)<br>ST 50 J/K Dax<br>XR 50 1/2/3<br>ATC 70 All Models<br>C 70 Z2/ZZ/C/D/DMC<br>CRF 70 F4/F5/F6/F7<br>XR 70 RV/RW/RX/R1/R2/R3<br>C 90 C/E/G/MF/P/MP/MG/N/MN<br>P/MP/T/MT  | 78-81<br>82-93<br>95<br>96-02<br>77-78<br>04-07<br>03<br>78-93<br>01-03<br>79-85<br>77-85<br>04-07<br>97-03<br>82-03   | CK1155   | Use CK1119   |  |
| CK1149   | CB 750 KZ<br>CB 750 FA/FB/F2C<br>CB 900 FZ/FA/FB/F2B/F2C<br>CB 1100 RB2/RC2/RD2   | 80<br>79-82<br>80-83<br>80-82  | CK1156   | C 90 Z2/ZZ (From E/No.:-A073285)<br>ATC 110 All Models<br>CT 110 K/M/P<br>ATC 125 ME   | 75-81<br>79-84<br>89-93<br>84  |
| CK1150   | CB 50 J<br>CB 50 V/W Dream 50<br>CRM 50 RN/RP/RR/RT<br>MB 50<br>MBX 50 SD/SF<br>MTX 50 SC<br>NSR 50 FP/FR/FS<br>NSR 50 RV/RW/RX/R1<br>NSR 50 SK/SP/SR/SS<br>TLM 50 F<br>XZ 50 1/2 Ape-AC16<br>XR 75 K4/K5<br>CRF 80 F4/F5/F6<br>XR 80 Z/A/B<br>XR 80 R  | 81<br>97-98<br>93-96<br>80-82<br>83-85<br>83-87<br>93-95<br>97-00<br>89-95<br>85<br>01-02<br>78-79<br>04-06<br>80-81<br>87-88  | CK1157   | Use CK1163   |  |
| CK1150   | XR 50 M5 (AD14) Motard  | 05   | CK1158   | Use CK1191   |  |
| CK1151   | CR 50 RE/RF<br>CR 60 RF/RG<br>CRM 75 RK/RL/RM/RP/RR<br>NSR 75 N/P/R/X/Y (NS-1)<br>CR 80 RA/RB/RC/RD<br>MBX 80 FWDD/FWDF<br>MTX 80 RFD/RFF<br>NSR 80 J-2/K/L/N/P/R/S (HC06)<br>TRX 90 P/R/S/T/V/W/XY/1-6<br>TRX 90 EX<br>Astrea Supra NF 100<br>Astrea Grand/Supra<br>CRF 100 R4/R5/R6/R7<br>XL 100 SZ/SA/SB<br>XR 100 RP/RR/RS/RT/RV/RW/RX<br>/RY/R1/R2/R3<br>XR 100 M5 (HD13) Motard<br>XZ 100 2 APE-HC07<br>ATC 125 MG<br>H 100 A/SD/SG/SJ<br>CA 125 V/W/X<br>TRX 125 J<br>ATC 185 A/SB/SC/SD<br>ATC 200 (All models)<br><b>YAMAHA</b><br>YBR 125 ED (3D91) | 84-85<br>85-86<br>89-94<br>92-00<br>80-83<br>83-86<br>83-84<br>88-<br>93-06<br>07<br>99<br>97-98<br>04-07<br>78-82<br>93-03<br>05<br>02<br>86<br>84-92<br>98-00<br>88<br>80-83<br>81-85<br>05-07 | CK1159   | CX 500 TC 'Turbo'<br>CX 650 TD 'Turbo'<br>GL 1100 A/DA/BI/B/DB   | 82<br>83   |
| CK1151   | CR 50 RE/RF<br>CR 60 RF/RG<br>CRM 75 RK/RL/RM/RP/RR<br>NSR 75 N/P/R/X/Y (NS-1)<br>CR 80 RA/RB/RC/RD<br>MBX 80 FWDD/FWDF<br>MTX 80 RFD/RFF<br>NSR 80 J-2/K/L/N/P/R/S (HC06)<br>TRX 90 P/R/S/T/V/W/XY/1-6<br>TRX 90 EX<br>Astrea Supra NF 100<br>Astrea Grand/Supra<br>CRF 100 R4/R5/R6/R7<br>XL 100 SZ/SA/SB<br>XR 100 RP/RR/RS/RT/RV/RW/RX<br>/RY/R1/R2/R3<br>XR 100 M5 (HD13) Motard<br>XZ 100 2 APE-HC07<br>ATC 125 MG<br>H 100 A/SD/SG/SJ<br>CA 125 V/W/X<br>TRX 125 J<br>ATC 185 A/SB/SC/SD<br>ATC 200 (All models)<br><b>YAMAHA</b><br>YBR 125 ED (3D91) | 84-85<br>85-86<br>89-94<br>92-00<br>80-83<br>83-86<br>83-84<br>88-<br>93-06<br>07<br>99<br>97-98<br>04-07<br>78-82<br>93-03<br>05<br>02<br>86<br>84-92<br>98-00<br>88<br>80-83<br>81-85<br>05-07 | CK1160   | CRM 125 RL/RM/RN/RP/RR/RV/RX<br>NSR 125 FM/RK/RL/SM/RN/RR/<br>RP/FP/RV/RW/RX/R1/R2/R3<br>TRX 350 TE/FE Fourtrax Rancher<br>ES/ES 4x4 (FEY/1-5)<br>NT 400 Bros (NC25)<br>NV 400 CJ/CK (Steed)<br>NV 400 CS/CV Steed<br>VRX 400 T (NC33)<br>VT 500 ED/EF   | 90-99<br>90-03<br>00-05<br>92-93<br>95-97<br>96<br>83-85                                     |
| CK1151   | CR 50 RE/RF<br>CR 60 RF/RG<br>CRM 75 RK/RL/RM/RP/RR<br>NSR 75 N/P/R/X/Y (NS-1)<br>CR 80 RA/RB/RC/RD<br>MBX 80 FWDD/FWDF<br>MTX 80 RFD/RFF<br>NSR 80 J-2/K/L/N/P/R/S (HC06)<br>TRX 90 P/R/S/T/V/W/XY/1-6<br>TRX 90 EX<br>Astrea Supra NF 100<br>Astrea Grand/Supra<br>CRF 100 R4/R5/R6/R7<br>XL 100 SZ/SA/SB<br>XR 100 RP/RR/RS/RT/RV/RW/RX<br>/RY/R1/R2/R3<br>XR 100 M5 (HD13) Motard<br>XZ 100 2 APE-HC07<br>ATC 125 MG<br>H 100 A/SD/SG/SJ<br>CA 125 V/W/X<br>TRX 125 J<br>ATC 185 A/SB/SC/SD<br>ATC 200 (All models)<br><b>YAMAHA</b><br>YBR 125 ED (3D91) | 84-85<br>85-86<br>89-94<br>92-00<br>80-83<br>83-86<br>83-84<br>88-<br>93-06<br>07<br>99<br>97-98<br>04-07<br>78-82<br>93-03<br>05<br>02<br>86<br>84-92<br>98-00<br>88<br>80-83<br>81-85<br>05-07 | CK1161   | Use CK1205   |  |
| CK1151   | CR 50 RE/RF<br>CR 60 RF/RG<br>CRM 75 RK/RL/RM/RP/RR<br>NSR 75 N/P/R/X/Y (NS-1)<br>CR 80 RA/RB/RC/RD<br>MBX 80 FWDD/FWDF<br>MTX 80 RFD/RFF<br>NSR 80 J-2/K/L/N/P/R/S (HC06)<br>TRX 90 P/R/S/T/V/W/XY/1-6<br>TRX 90 EX<br>Astrea Supra NF 100<br>Astrea Grand/Supra<br>CRF 100 R4/R5/R6/R7<br>XL 100 SZ/SA/SB<br>XR 100 RP/RR/RS/RT/RV/RW/RX<br>/RY/R1/R2/R3<br>XR 100 M5 (HD13) Motard<br>XZ 100 2 APE-HC07<br>ATC 125 MG<br>H 100 A/SD/SG/SJ<br>CA 125 V/W/X<br>TRX 125 J<br>ATC 185 A/SB/SC/SD<br>ATC 200 (All models)<br><b>YAMAHA</b><br>YBR 125 ED (3D91) | 84-85<br>85-86<br>89-94<br>92-00<br>80-83<br>83-86<br>83-84<br>88-<br>93-06<br>07<br>99<br>97-98<br>04-07<br>78-82<br>93-03<br>05<br>02<br>86<br>84-92<br>98-00<br>88<br>80-83<br>81-85<br>05-07 | CK1162   | Use CK4409   |  |
| CK1151   | CR 50 RE/RF<br>CR 60 RF/RG<br>CRM 75 RK/RL/RM/RP/RR<br>NSR 75 N/P/R/X/Y (NS-1)<br>CR 80 RA/RB/RC/RD<br>MBX 80 FWDD/FWDF<br>MTX 80 RFD/RFF<br>NSR 80 J-2/K/L/N/P/R/S (HC06)<br>TRX 90 P/R/S/T/V/W/XY/1-6<br>TRX 90 EX<br>Astrea Supra NF 100<br>Astrea Grand/Supra<br>CRF 100 R4/R5/R6/R7<br>XL 100 SZ/SA/SB<br>XR 100 RP/RR/RS/RT/RV/RW/RX<br>/RY/R1/R2/R3<br>XR 100 M5 (HD13) Motard<br>XZ 100 2 APE-HC07<br>ATC 125 MG<br>H 100 A/SD/SG/SJ<br>CA 125 V/W/X<br>TRX 125 J<br>ATC 185 A/SB/SC/SD<br>ATC 200 (All models)<br><b>YAMAHA</b><br>YBR 125 ED (3D91) | 84-85<br>85-86<br>89-94<br>92-00<br>80-83<br>83-86<br>83-84<br>88-<br>93-06<br>07<br>99<br>97-98<br>04-07<br>78-82<br>93-03<br>05<br>02<br>86<br>84-92<br>98-00<br>88<br>80-83<br>81-85<br>05-07 | CK1163   | CR 250 R/RZ/RA<br>ATC 250 RB/RC/RD   | 78-80<br>81-83   |
| CK1151   | CR 50 RE/RF<br>CR 60 RF/RG<br>CRM 75 RK/RL/RM/RP/RR<br>NSR 75 N/P/R/X/Y (NS-1)<br>CR 80 RA/RB/RC/RD<br>MBX 80 FWDD/FWDF<br>MTX 80 RFD/RFF<br>NSR 80 J-2/K/L/N/P/R/S (HC06)<br>TRX 90 P/R/S/T/V/W/XY/1-6<br>TRX 90 EX<br>Astrea Supra NF 100<br>Astrea Grand/Supra<br>CRF 100 R4/R5/R6/R7<br>XL 100 SZ/SA/SB<br>XR 100 RP/RR/RS/RT/RV/RW/RX<br>/RY/R1/R2/R3<br>XR 100 M5 (HD13) Motard<br>XZ 100 2 APE-HC07<br>ATC 125 MG<br>H 100 A/SD/SG/SJ<br>CA 125 V/W/X<br>TRX 125 J<br>ATC 185 A/SB/SC/SD<br>ATC 200 (All models)<br><b>YAMAHA</b><br>YBR 125 ED (3D91) | 84-85<br>85-86<br>89-94<br>92-00<br>80-83<br>83-86<br>83-84<br>88-<br>93-06<br>07<br>99<br>97-98<br>04-07<br>78-82<br>93-03<br>05<br>02<br>86<br>84-92<br>98-00<br>88<br>80-83<br>81-85<br>05-07 | CK1164   | Use CK1191   |  |
| CK1151   | CR 50 RE/RF<br>CR 60 RF/RG<br>CRM 75 RK/RL/RM/RP/RR<br>NSR 75 N/P/R/X/Y (NS-1)<br>CR 80 RA/RB/RC/RD<br>MBX 80 FWDD/FWDF<br>MTX 80 RFD/RFF<br>NSR 80 J-2/K/L/N/P/R/S (HC06)<br>TRX 90 P/R/S/T/V/W/XY/1-6<br>TRX 90 EX<br>Astrea Supra NF 100<br>Astrea Grand/Supra<br>CRF 100 R4/R5/R6/R7<br>XL 100 SZ/SA/SB<br>XR 100 RP/RR/RS/RT/RV/RW/RX<br>/RY/R1/R2/R3<br>XR 100 M5 (HD13) Motard<br>XZ 100 2 APE-HC07<br>ATC 125 MG<br>H 100 A/SD/SG/SJ<br>CA 125 V/W/X<br>TRX 125 J<br>ATC 185 A/SB/SC/SD<br>ATC 200 (All models)<br><b>YAMAHA</b><br>YBR 125 ED (3D91) | 84-85<br>85-86<br>89-94<br>92-00<br>80-83<br>83-86<br>83-84<br>88-<br>93-06<br>07<br>99<br>97-98<br>04-07<br>78-82<br>93-03<br>05<br>02<br>86<br>84-92<br>98-00<br>88<br>80-83<br>81-85<br>05-07 | CK1165   | VF 400 FD  | 83-85  |
| CK1151   | CR 50 RE/RF<br>CR 60 RF/RG<br>CRM 75 RK/RL/RM/RP/RR<br>NSR 75 N/P/R/X/Y (NS-1)<br>CR 80 RA/RB/RC/RD<br>MBX 80 FWDD/FWDF<br>MTX 80 RFD/RFF<br>NSR 80 J-2/K/L/N/P/R/S (HC06)<br>TRX 90 P/R/S/T/V/W/XY/1-6<br>TRX 90 EX<br>Astrea Supra NF 100<br>Astrea Grand/Supra<br>CRF 100 R4/R5/R6/R7<br>XL 100 SZ/SA/SB<br>XR 100 RP/RR/RS/RT/RV/RW/RX<br>/RY/R1/R2/R3<br>XR 100 M5 (HD13) Motard<br>XZ 100 2 APE-HC07<br>ATC 125 MG<br>H 100 A/SD/SG/SJ<br>CA 125 V/W/X<br>TRX 125 J<br>ATC 185 A/SB/SC/SD<br>ATC 200 (All models)<br><b>YAMAHA</b><br>YBR 125 ED (3D91) | 84-85<br>85-86<br>89-94<br>92-00<br>80-83<br>83-86<br>83-84<br>88-<br>93-06<br>07<br>99<br>97-98<br>04-07<br>78-82<br>93-03<br>05<br>02<br>86<br>84-92<br>98-00<br>88<br>80-83<br>81-85<br>05-07 | CK1166   | CBX 750 FE<br>VF 750 SC<br>VF 750 CH<br>VF 750 S 'Sabre'<br>VT 750 C 'Shadow'  | 84-85<br>82<br>87<br>82-83<br>83   |
| CK1151   | CR 50 RE/RF<br>CR 60 RF/RG<br>CRM 75 RK/RL/RM/RP/RR<br>NSR 75 N/P/R/X/Y (NS-1)<br>CR 80 RA/RB/RC/RD<br>MBX 80 FWDD/FWDF<br>MTX 80 RFD/RFF<br>NSR 80 J-2/K/L/N/P/R/S (HC06)<br>TRX 90 P/R/S/T/V/W/XY/1-6<br>TRX 90 EX<br>Astrea Supra NF 100<br>Astrea Grand/Supra<br>CRF 100 R4/R5/R6/R7<br>XL 100 SZ/SA/SB<br>XR 100 RP/RR/RS/RT/RV/RW/RX<br>/RY/R1/R2/R3<br>XR 100 M5 (HD13) Motard<br>XZ 100 2 APE-HC07<br>ATC 125 MG<br>H 100 A/SD/SG/SJ<br>CA 125 V/W/X<br>TRX 125 J<br>ATC 185 A/SB/SC/SD<br>ATC 200 (All models)<br><b>YAMAHA</b><br>YBR 125 ED (3D91) | 84-85<br>85-86<br>89-94<br>92-00<br>80-83<br>83-86<br>83-84<br>88-<br>93-06<br>07<br>99<br>97-98<br>04-07<br>78-82<br>93-03<br>05<br>02<br>86<br>84-92<br>98-00<br>88<br>80-83<br>81-85<br>05-07 | CK1167   | VF 750 FD/FE<br>XRV 750 L/M/N/P/R/S/T/V/W/X/Y<br>PC 800 Pacific Coast  | 83-85<br>90-03<br>89-97  |
| CK1151   | CR 50 RE/RF<br>CR 60 RF/RG<br>CRM 75 RK/RL/RM/RP/RR<br>NSR 75 N/P/R/X/Y (NS-1)<br>CR 80 RA/RB/RC/RD<br>MBX 80 FWDD/FWDF<br>MTX 80 RFD/RFF<br>NSR 80 J-2/K/L/N/P/R/S (HC06)<br>TRX 90 P/R/S/T/V/W/XY/1-6<br>TRX 90 EX<br>Astrea Supra NF 100<br>Astrea Grand/Supra<br>CRF 100 R4/R5/R6/R7<br>XL 100 SZ/SA/SB<br>XR 100 RP/RR/RS/RT/RV/RW/RX<br>/RY/R1/R2/R3<br>XR 100 M5 (HD13) Motard<br>XZ 100 2 APE-HC07<br>ATC 125 MG<br>H 100 A/SD/SG/SJ<br>CA 125 V/W/X<br>TRX 125 J<br>ATC 185 A/SB/SC/SD<br>ATC 200 (All models)<br><b>YAMAHA</b><br>YBR 125 ED (3D91) | 84-85<br>85-86<br>89-94<br>92-00<br>80-83<br>83-86<br>83-84<br>88-<br>93-06<br>07<br>99<br>97-98<br>04-07<br>78-82<br>93-03<br>05<br>02<br>86<br>84-92<br>98-00<br>88<br>80-83<br>81-85<br>05-07 | CK1168   | Use CK1170   |  |
| CK1151   | CR 50 RE/RF<br>CR 60 RF/RG<br>CRM 75 RK/RL/RM/RP/RR<br>NSR 75 N/P/R/X/Y (NS-1)<br>CR 80 RA/RB/RC/RD<br>MBX 80 FWDD/FWDF<br>MTX 80 RFD/RFF<br>NSR 80 J-2/K/L/N/P/R/S (HC06)<br>TRX 90 P/R/S/T/V/W/XY/1-6<br>TRX 90 EX<br>Astrea Supra NF 100<br>Astrea Grand/Supra<br>CRF 100 R4/R5/R6/R7<br>XL 100 SZ/SA/SB<br>XR 100 RP/RR/RS/RT/RV/RW/RX<br>/RY/R1/R2/R3<br>XR 100 M5 (HD13) Motard<br>XZ 100 2 APE-HC07<br>ATC 125 MG<br>H 100 A/SD/SG/SJ<br>CA 125 V/W/X<br>TRX 125 J<br>ATC 185 A/SB/SC/SD<br>ATC 200 (All models)<br><b>YAMAHA</b><br>YBR 125 ED (3D91) | 84-85<br>85-86<br>89-94<br>92-00<br>80-83<br>83-86<br>83-84<br>88-<br>93-06<br>07<br>99<br>97-98<br>04-07<br>78-82<br>93-03<br>05<br>02<br>86<br>84-92<br>98-00<br>88<br>80-83<br>81-85<br>05-07 | CK1169   | Use CK1190   |  |
| CK1151   | CR 50 RE/RF<br>CR 60 RF/RG<br>CRM 75 RK/RL/RM/RP/RR<br>NSR 75 N/P/R/X/Y (NS-1)<br>CR 80 RA/RB/RC/RD<br>MBX 80 FWDD/FWDF<br>MTX 80 RFD/RFF<br>NSR 80 J-2/K/L/N/P/R/S (HC06)<br>TRX 90 P/R/S/T/V/W/XY/1-6<br>TRX 90 EX<br>Astrea Supra NF 100<br>Astrea Grand/Supra<br>CRF 100 R4/R5/R6/R7<br>XL 100 SZ/SA/SB<br>XR 100 RP/RR/RS/RT/RV/RW/RX<br>/RY/R1/R2/R3<br>XR 100 M5 (HD13) Motard<br>XZ 100 2 APE-HC07<br>ATC 125 MG<br>H 100 A/SD/SG/SJ<br>CA 125 V/W/X<br>TRX 125 J<br>ATC 185 A/SB/SC/SD<br>ATC 200 (All models)<br><b>YAMAHA</b><br>YBR 125 ED (3D91) | 84-85<br>85-86<br>89-94<br>92-00<br>80-83<br>83-86<br>83-84<br>88-<br>93-06<br>07<br>99<br>97-98<br>04-07<br>78-82<br>93-03<br>05<br>02<br>86<br>84-92<br>98-00<br>88<br>80-83<br>81-85<br>05-07 | CK1170   | CR 250 RD-RK<br>CR 480 RD<br>CR 500 RE/RG/RH/RJ/RK<br>NX 500 J/K/L/M/N/P/R/S/T/V/W/X<br>Dominator<br>XR 500 RD/RE<br>SLR 650 V/W<br>XL 600 RD/RF/LMF/LD/RE/LE/REG/RH<br>XR 600 RF/RG/RH/RJ/RK/RL/RM/<br>RP/RR/RS/RT/RV/RW/RX/R1/R2/R3<br>FMX 650 5/6<br>FX 650 X/Y<br>NX 650 J/K/L/M/N/P/R/S/T/V/W/X | 83-89<br>83<br>84-89<br>88-99<br>84-85<br>97-98<br>83-87<br>89-00<br>05-06<br>99-03<br>88-01 |

| Part No. | Make/Model   | Year                  | Part No. | Make/Model  | Year   |                   |
|----------|--|-----------------------|----------|---|--|-------------------|
| CK1171   | <b>HONDA Cont.</b><br>No fitment   |                       | CK1189   | <b>HONDA Cont.</b><br>Use CK1159  |  |                   |
| CK1172   | Use CK1166   |                       | CK1190   | CR 125 RD/RE<br>AX-1 (NX 250 J/K/R/R3)<br>CBF 250 4<br>NX 250 J/K/L (MD21)<br>NX 250 2L/M/P/2P<br>XL 250 Degree<br>XLR 250 R - 6 Plate 'Baja'<br>CRM 250-3<br>XR 250 RG/RH/RJ/RK/RL/RM/RN/RP<br>/RR/RSRT/RV/RW/RX/R/Y/R1/R2/R3<br>XR 250 Y/3 (MD30)<br>XR 250 3/5 (MD30) Motard<br>XR 250 III Y/3 Baja<br>TRX 300 EX All models<br>XR 350 RD/RE | 83-84<br>89-94<br>04-06<br>87-90<br>90-93  |                   |
| CK1173   | Use CK1190   |                       |          |   | 94-  |                   |
| CK1174   | Use CK1180   |                       |          |   | 86-03  |                   |
| CK1175   | No fitment   |                       |          |   | 00-03  |                   |
| CK1176   | VF 1000 FE/FF/RE/RF/RG/F2F<br>VT 1100 C3 Shadow<br>VT 1100 C4 Shadow Sabre   | 84-86<br>04-05        |          |   | 03-05  |                   |
| CK1177   | VFR 400 ZG/ZH/RG/RG-YA/RH2/RJ (NC21/24)  | 85-88                 |          |   | 00-03  |                   |
|          | VF 500 FE/F2E/FF/F2F   | 84-85                 |          |   | 93-07  |                   |
|          | <b>SUZUKI</b><br>GSX 400 R/S/T/X/ZR/ZS/ZT<br>'Impulse Type S'<br>RF 400 RP/RR/VR/RT/RVT/RV-V (GK78A)<br>RV 400 RP/RR   | 94-99<br>93-97<br>93- |          |   | 83-84  |                   |
| CK1178   | No Fitment   |                       |          |   | <b>HONDA-DALL'ARA</b><br>XR 250 R<br>XR 250 SM<br>TRX 300 EX P/R/S/T/V/W/X/Y/1-5 | 04<br>04<br>93-05 |
| CK1179   | Use CK1146   |                       |          |   | <b>MOTO ROMA</b><br>Geko 300 Quad  | 04-06             |
| CK1180   | MBX 125 FE<br>MTX 125 RWD/E/F/H/L<br>MTX 200 RWF<br>XR 200 R<br>XL 250 RE-RF<br>XLR 250 R - 5 Plate 'Baja'<br>XR 250 RE/RF<br><b>KAWASAKI</b><br>KLF 220 A1-A15<br>CRM 250 RR/RR-II (MD24) 140 MK3<br>KLF 250 A1/A2  | 84-86                 | CK1191   | CR 125 RB<br>CRF 150 RB7/R7<br>CB 250 N/T/W/X/Y/1/4 "Two Fifty"<br>VT 250 FD<br>CD250 UJ/UK<br>CMX 250 CT/CV/CW/CX  | 81   |                   |
|          |  | 83-95                 |          |   | 07   |                   |
|          |  | 85                    |          |   | 93-05  |                   |
|          |  | 84-85                 |          |   | 83   |                   |
|          |  | 84-85                 |          |   | 88-92  |                   |
| CK1181   | CRM 250 ARV/ARW (MD32)<br>CRM 250 MK3<br>NSR 250 RG/R2J (MC16/18)<br>NSR 250 RSP/RSK (MC18)<br>NSR 250 R7L/R7N (MC21106)<br>NSR 250 RR (MC28)<br>CB 400 SS (CB 400 SS2-J<br>/SS2-3J-NC41)<br>CBR 400 RRL/RRN/RRR (NC29)<br>CB 500 R/T/V/W/SW/Y/SY/2/S2<br>CBF 500 4/A4/A5/A6/A7<br>XL 600 VH/VJ/VM/VN/VP/VR/VT<br>/VV/VW/VX Transalp<br>VT 600 CN/CR/CS/CT/CV/CW/CX<br><b>SUZUKI</b><br>DR 250 RS/RLS/RT/RV/RLV/RW/RLW<br>/RY (SJ45A/DOHC)<br>DR 250 RXT/RXLT/RXV/RXLV/RXW<br>/RXLW/RXGW/RXGLW/RXY/RXGY<br>(Dejbel 250 XC/GPS Ver SJ45A)<br>DR-Z 250 K1-K7<br><b>TRIUMPH</b><br>Daytona 650<br>Speedfour | 97-98                 | CK1192   | Use CK1191  |  |                   |
|          |  | 95-96                 |          |   |  |                   |
|          |  | 86-88                 |          |   |  |                   |
|          |  | 95-                   |          |   |  |                   |
|          |  | 01                    |          |   |  |                   |
|          |  | 90-94                 |          |   |  |                   |
|          |  | 94-03                 |          |   |  |                   |
|          |  | 04-07                 |          |   |  |                   |
|          |  | 87-00                 |          |   |  |                   |
|          |  | 92-00                 |          |   |  |                   |
|          |  | 95-00                 |          |   |  |                   |
|          |  | 01-07                 |          |   |  |                   |
|          |  | 05                    |          |   |  |                   |
|          |  | 02-05                 |          |   |  |                   |
|          |  | CK1182                |          |   | No fitment   |                   |
| CK1183   | CBX 1000 Z/B/C   | 79-81                 | CK1194   | TRX 250 F/G/H<br>ATC 250 ESF/ESG/ESH/ESJ  | 85-87<br>85-88   |                   |
| CK1184   | Use CK1119   |                       | CK1195   | Use CK1193  |  |                   |
| CK1185   | Use CK1119   |                       | CK1196   | TRX 300 FWJ/FWK/FWL/FWT/FWV<br>/FWW/FWX/J/K/L/T/V/W/X/Y<br>TRX 350 G/H/J/K/L/M/N<br>TRX 350 FMY/1-5 Fourtrax Rancher/4x4<br>TRX 400 FWS/T/V/W/X/Y<br>TRX 420 FE7/TE7 Fourtrax Rancher<br>TRX 450 ESW/ESX/ESY/ES1  | 88-00<br>86-93<br>00-05<br>95-00<br>07<br>98-01                                  |                   |
| CK1186   | CR125 RC   | 82                    | CK1197   | Use CK1151  |  |                   |
| CK1187   | Use CK1228   |                       | CK1198   | Use CK1119  |  |                   |
| CK1188   | Use CK1170   |                       | CK1199   | CR 125 RZ/RA  | 79-80  |                   |
|          |  |                       | CK1200   | CR 125 RF   | 85   |                   |
|          |  |                       | CK1201   | Use CK1222  |  |                   |
|          |  |                       | CK1202   | Use CK1131  |  |                   |
|          |  |                       | CK1203   | Use CK1190  |  |                   |
|          |  |                       | CK1204   | Use CK1140  |  |                   |

| Part No. | Make/Model   | Year   | Part No. | Make/Model   | Year  |
|----------|--|--|----------|--|---|
| CK1205   | <b>HONDA Cont.</b><br>Use CK1147   |  | CK1223   | <b>HONDA Cont.</b><br>CB 750/CB 750 K1<br>(Up to E/No.:1056079)  | 69-70   |
| CK1206   | CBR 600 FM/FN/FP/FR/FS/FT/FV/FW<br>CB 600 FW/FX/FY/FSY/F2Y/F21<br>/F1/F2/F22/F3/F4/F5/F6 Hornet<br>CBF 600 N4/NA4/S4/SA4/N5/<br>NA5/S5/SA5/N6/NA6/SA6/SA7<br>VFR 750 FG/FH/FJ/FL/FM/FN/FP/<br>FR/FS/FT/FV<br>VF 750 CP/CR/CS/CT/CV<br>VFR 800 Fi-W/Fi-X<br>CBR 900 RRP/RRN/RRR/RRS<br>CBR 900 RRY/RR1 (929cc Fireblade)<br>CBR 900 RR2/RR3 954cc Fireblade<br><b>SUZUKI</b><br>GSXR 600 V/W/X/Y/K1/K2/K3/ZK3/K4/K5<br><b>TRIUMPH</b><br>TT 600<br>Speed Four 600<br>Daytona 600<br>Daytona 675 | 91-98<br>98-06<br>04-07<br>86-97<br>93-97<br>98-99<br>92-95<br>00-01<br>02-03<br>97-05<br>00-03<br>02-05<br>03-04<br>06-07 | CK1224   | GL 1200 DH/AH/AG/DG  | 86-87   |
| CK1207   | Use CK1149   |  | CK1225   | Use CK1248   |   |
| CK1208   |  |  | CK1226   | Use CK1147   |   |
| CK1209   |  |  | CK1227   | Use CK1165   |   |
| CK1210   | GL 1200 AE/DE/AF   | 84-85  | CK1228   | CB-1 (CB 400 F)<br>CB 400 SF (F2N/F2R) (Super Four)<br>CB 400 SF (F2V/F3T) Superfour<br>CB 400 SF (F3V) Superfour<br>CB 400 Four V/V-II/W-II (NC36)<br>CBR 400 RG/RH-YA (NC23)<br>CBR 400 RRJ/RRK (NC23)<br>CBR 500 FH/FJ/FK/FL<br>CBX 550 FC/F2C/FD/F2D<br>CBR 600 FH/FJ/FK/FL                          | 89-90<br>92-<br>96-97<br>97<br>97-98<br>86-87<br>92-93<br>87-90<br>82-85<br>87-90   |
| CK1211   | Use CK1224   |  | CK1229   | VFR 750 RJ/RK/RL (RC30)<br><b>SUZUKI</b><br>GSXR 750 Y/K1/K2/K3  | 88-92<br>00-03  |
| CK1212   | Use CK1119   |  | CK1230   | NTV 600 J/K/M<br>NTV 650 J/K/L/M/P/S/T/V<br>NT 650 J/K/L (BRO5)<br>NT 650 VW/VX/VY/V1-V5 Deauville<br>XL 650 VY/V1/V2/V3/V4/V5/V6/V7<br>XRV 650 J/K<br>NT 700 V6/VA7 Deauville<br>VT 750 CV/C2V/CW/C2W/CX/C2X<br>/CY/C2Y/C1/C21/C4/C5/C6/C7<br>VT 750 DC1/DC2 'Black Widow'<br>VT 750 DCA7 Shadow Spirit | 88-91<br>93-97<br>88-92<br>98-05<br>00-07<br>88-89<br>06-07<br>97-07<br>01-03<br>07 |
| CK1214   | Use CK1153   |  | CK1231   | Use CK1228   |   |
| CK1215   | Use CK1217   |  | CK1232   | Use CK1233   |   |
| CK1216   | Use CK1119   |  | CK1233   | USE CK1285   |   |
| CK1217   | MTX 200 RWD<br>CBX 250 RSE<br>GB 250 E/H/J/L/P/S/V 'Custom'  | 83-84<br>84<br>84-97   | CK1234   | FL 400 R/RK/RL 'Pilot'   | 89-93   |
| CK1218   | NS 250 FE (MC11)<br>NS 250 RE/RG (MC11)<br>NS 400 RF/RG<br>CBR 600 F2/F3/F4/F5/F6/F7<br>CBR 600 FS1/2<br>CBR 600 RR3/RR4/RR5/RR6<br>VFR 800 2/A2/3/A3/4/A4/5/A5/6/A6<br>/A7/7<br>CB 900 F2/F3/F4/F5/F6/F7 Hornet<br>CBR 900 RRW/RRX/RRY<br><b>SUZUKI</b><br>GSR 600 K6/AK7   | 84<br>84-86<br>85-87<br>02-07<br>01-02<br>03-06<br>02-07<br>02-07<br>98-00<br>06-07  | CK1235   | CB 250 FT/FV/FX/FY/F1<br>CBR 250 FG/RH/RJ/RK/RK2<br>CBR 250 RRL/RRN/RRR<br>VTZ 250 H/J/K<br>VT 250 CR 'Magna'<br>VT 250 FL Spada/Castec<br>VTR 250 W/Y/1-7 (MC33)  | 96-01<br>86-89<br>90-94<br>86-88<br>88-90<br>98-07                                  |
| CK1219   | <b>HONDA</b><br>GB 500 TT<br>XBR 500 F/G/H/SH/SJ<br><b>SUZUKI</b><br>DL 650 K4/K5/K6<br>DL 650 AK7 VStrom ABS<br>DL 650 K7<br>SV 650 SK3/K3/SK4/K4/SK5/K5/K6<br>/SK6/SK7/ASK7/AK7/K7   | 85-89<br>04-06<br>07<br>07<br>03-07  | CK1236   | Use CK1181   |   |
| CK1220   | CB 750 F/F1  | 76-77  | CK1237   | Use CK1230   |   |
| CK1221   | GL 1000 K1 (Up to E/No.2002383)  | 77   | CK1238   | Use CK1167   |   |
| CK1222   | CR 125 RG/RH/RJ/RK/RL/RM/RN/<br>RP/RR/RS/RT/RV/RW/RX   | 86-99  | CK1239   | VT 1100 CH/CJ/CN/CP Shadow<br>VT 1100 CR/CS/CT/CV/CW Shadow  | 87-93<br>94-98  |
|          |  |  | CK1240   | Use CK1252   |   |
|          |  |  | CK1241   | Use CK1190   |   |
|          |  |  | CK1242   | Use CK1217   |   |
|          |  |  | CK1243   | Use CK1181   |   |
|          |  |  | CK1244   | Use CK1181   |   |
|          |  |  | CK1245   | Use CK1230   |   |
|          |  |  | CK1246   | Use CK1235   |   |



| Part No. | Make/Model   | Year  | Part No.       | Make/Model  | Year   |                         |
|----------|--|---|----------------|---|--|-------------------------|
| CK1247   | <b>HONDA Cont.</b><br>CR 250 RL/RM/RN/RP/RR/RS/RT/RV<br>/RW/RX/R1/R2/R3/R4/R5/R6/R7<br>CRF 450 R2/R3/R4/R5/R6/R7<br>CRF 450 X5/X6/X7<br>CR 500 RLRM/RN/RP/RR/RS/RT<br>/RV/RW/RX/R1                 | 90-07<br>02-07<br>05-07   | CK1288         | <b>HONDA Cont.</b><br>NSR 250 RSP (R6KII)<br>NSR 250 RSP (MC21)<br>NSR 250 R2R/R2T/R3R/R3S/R3T (MC28) |  |                         |
|          | <b>KAWASAKI</b><br>KX 450 F (D6F/D7F)  | 90-01<br>06-07  |                | CK1289  | RVF 400 RR/RR-II/RT/RT-II (NC35)   | 94-96                   |
|          | CK1248   | CB 1000 FP/FR/FS/FT/FV<br>CBR 1000 FH/FJ/FK/FL/FM/FN/<br>FP/FR/FS/FT/FV/FW/FX | 93-97<br>87-99 | CK1290  | VTR 1000 FV/FW/FX/FY/F1/F2/F3<br>/F4/F5/F6 'Firestorm'<br>XL 1000 X/Y/V1/V2<br>CB 1300 DCV/DCW/DCX/DCY SC38      | 97-06<br>99-02<br>97-00 |
|          | CK1249   | Use CK1167  |                | CK1291  | CBR 1100 XXX/XXY/XX1/XX2/XX3<br>/XX4/XX5/XX6/XX7 'Blackbird'<br>CB 1100 SFY/SF1 "XII"<br>VTR 1000 SPY/SP1 (SC45) | 99-07<br>00-03<br>00-01 |
|          | CK1250   | VFR 400 R3K/R3L/R3M/R3N (NC30)  | 89-92          | CK1292  | VT 125 CX/CY/C1/C21/C3/C4/C7<br>XL 125 V1/V2/V3/V4/V5/V6/V7  | 99-07<br>01-07          |
| CK1251   | Use CK1247   |   | CK1293         | CR 125 RY/R1/R2/R3/R4/R5/R6/R7<br>CRF 250 R4/R5/R6/R7<br><b>KTM</b><br>EXC-F 250<br>SX-F 250          | 00-07<br>04-07<br><br>07<br>05-07  |                         |
| CK1252   | CB 125 TDJ<br>CBR 125 RR4/RR5/RS5/RW5/RR6<br>/RS6/R7<br>CG 125 M1/1/ES4<br>LS 125 R<br>CBR 150 R<br>TA 200 (TA Shadow)<br>FTR 223 Y/2/A2 (MC34)<br>SL 230 V/W/X/1<br>XL 230-2 (NC36)               | 87-89<br><br>04-07<br>01-07<br>00-<br>00-<br>02-05<br>00-02<br>97-02<br>02    |                | CK1294  | Use CK1206   |                         |
| CK1253   | VFR 800 Fi-Y/Fi-1  | 00-01   | CK1295         | XR 650 RY/R1-R7<br><b>HONDA-DALL'ARA</b><br>XR 650 R  | 00-07<br>04  |                         |
| CK1254   | Use CK1233   |   | CK1296         | USE CK1151  |  |                         |
| CK1255   | Use CK1230   |   | CK1297         | ST 1300 2/A2/3/A3/4/A4/5/A5/6/A6/A7<br>GL 1800 A1/A2/A3/A4/A5/A6/A7 Goldwing                          | 02-07<br>01-07   |                         |
| CK1256   | Use CK1206   |   | CK1298         | VTX 1300 S3/S4/S5/S6/S7<br>VTX 1800 C2/C3/C4/C5   | 03-07<br>02-05   |                         |
| CK1257   | RVF 750 RR-R/RR-S (RC45)<br>XL 1000 V3/V4/VA4/V5/VA5<br>/V6/VA6/VA7 Varadero<br>CB 1300 F3/F13<br>CB 1300 5/6 (Superfour)<br>CB 1300 A5/A6/A7 (Superfour ABS)<br>CB 1300 SA5/SA6/SA7 Super Bol-dor | 94-98<br><br>03-07<br>03-04<br>05-06<br>05-07<br>05-07                        | CK1299         | CB 1300 FW/FX/FY/F1 (SC40)  | 98-01  |                         |
| CK1258   | Use CK1206   |   | CK1300         | VTR 1000 SP2/SP3/SP4/SP5/SP6  | 02-07  |                         |
| CK1261   | Use CK1191   |   | CK1302         | TRX 450 R4/R5/R6/ER6/R7/ER7   | 04-07  |                         |
| CK1264   | ST1100 L/M/N/P/R/S/TN/W/X/Y/1/AN<br>/AP/AR/AS/AT/AV/AW/AX/AY/A1  | 90-01   | CK1303         | CBR 1000 RR4/RR5/RR6/RR7<br>CBF 1000 FA6/FA7 (ABS Model)<br>CBF 1000 F6/F7                            | 04-07<br>06-07<br>06-07  |                         |
| CK1265   | CB 400 SFX/SFY/SF1/SF2/SF3<br>/SF4/S/S5 Super Four (NC39)<br>CB 750 F2N/F2R/<br>F2S/F2T/F2W/F2X/F2Y/F21  | 99-05<br><br>92-02  | CK1304         | CRF 150 F3/F4/F5<br>CRF 230 F4/F5/F6/F7   | 03-05<br>04-05   |                         |
| CK1266   | Use CK1190   |   | CK1305         | CRF 250 X4/X5/X6/X7   | 04-07  |                         |
| CK1268   | Use CK1160   |   | CK1307         | ANF 125 3/5/T5/6/7 Innova   | 03-07  |                         |
| CK1273   | Use CK1181   |   | CK1308         | <b>ELSTARS (Pit bikes)</b><br>Various models  |  |                         |
| CK1275   | Use CK1257   |   |                | <b>YAMAHA</b><br>No fitment   |  |                         |
| CK1278   | Use CK1206   |   | CK2203         | Use CK2303  |  |                         |
| CK1284   | CBR 900 RRT/RRV  | 96-97   | CK2204         | No fitment  |  |                         |
| CK1285   | GL 1500 CV/CW/CX/CY/C1/C2 'F6C'<br>GL 1500 SEV/SEW/SEX/SEY<br>GL 1500 J-SES  | 97-02<br>97-00<br>88-96   | CK2205         | DT 50 M/MX<br>FS1E/FS1DX/FS1/FS1SE<br>RD 50/M/MX<br>TY 50M (2KO)<br>RD 80<br>TY 80                    | 80-95<br>74-90<br>80-87<br>80<br>82<br>77-83   |                         |
| CK1286   | CBR 1100 XXV/XXW 'Blackbird'   | 97-98   |                |   |  |                         |
| CK1287   | CBR 750 FH/FJ (Superaero)  | 87-88   |                |   |  |                         |

| Part No.            | Make/Model  | Year   | Part No.                           | Make/Model                                      | Year           |
|---------------------|---|--|------------------------------------|---|----------------|
| CK2206              | <b><u>YAMAHA Cont.</u></b>  |  | CK2235                             | <b><u>YAMAHA Cont.</u></b>                      |                |
|                     | DT 50 M   | 78-79  |                                    | YZ 125 D/E                                      | 77-78          |
|                     | DT 50 MX Type 5J2/12Y   | 81-83  |                                    | YZ 125 H  | 81             |
|                     | DT 50 LC  | 98   |                                    | IT 175 G-J                                      | 80-82          |
|                     | RD 50 M   | 78-79  |                                    | IT 200 L  | 84             |
| CK2207              | YB 100  | 78-92  | CK2236                             | DT 100  | 76-80          |
|                     |   |  |                                    | DT 125/125F/125E/125 MX                         | 76-81          |
| RD 125 DX           | 75-76   |  |                                    |   |                |
| RS 125/125 DX       | 75-76   |  |                                    |   |                |
| CK2208              | RS 100<br>AG 100 E 'Farm Bike'<br>AG 100 J (3HAA)   | 75-76<br>93<br>82  | DT 175                             | 74-77   |                |
|                     |   |  | CK2237                             | Use CK2254                                      |                |
| CK2209              | DT 125<br>RD 200 DX<br>RS 200   | 74<br>76-81<br>79-80   | CK2238                             | RZ 50 (5FC1/2)                                  | 02             |
|                     |   |  |                                    | RD 80 LC  | 82             |
|                     |   |  |                                    | YZ 80 G   | 80             |
| DT 80 MX (Type 36N) | 83-85   |  |                                    |   |                |
| DT 80 MXS           | 84  |  |                                    |   |                |
| CK2210              | No fitment  |  | YZ 80 D                            | 77  |                |
|                     |   |  | CK2239                             | Use CK2279                                      |                |
| CK2211              | No fitment  |  | CK2240                             | DT 250  | 75-76          |
| CK2212              | No fitment  |  |                                    | RD 250 A-F                                      | 75-79          |
| CK2213              | Use CK2330  |  |                                    | RD 250 LC                                       | 80-82          |
| CK2214              | Use CK2240  |  |                                    | RZ 250 R (1AR/1XG)                              |                |
| CK2215              | Use CK2330  |  |                                    | RZ 250 R (29L)                                  |                |
| CK2216              | No fitment  |  |                                    | RZ 250 RR (51L)                                 |                |
|                     |   |  |                                    | RZ 250 (4L3)                                    |                |
| CK2217              | No fitment  |  |                                    | TY 250 D/E                                      | 77-78          |
|                     |   |  |                                    | RD 350 A/B                                      | 74-75          |
| CK2218              | No fitment  |  |                                    | RD 350 LC/YPVS                                  | 80-84          |
|                     |   |  |                                    | RD 350 N/F/F2/R                                 | 85-95          |
| CK2219              | Use CK2236  |  |                                    | TT 350 A (3GJ)                                  | 90-95          |
|                     |   |  |                                    | XT 350  | 85-95          |
| CK2220              | Use CK2255  |  |                                    | YFM 350 FX 'Wolverine' All models               | 95-03          |
|                     |   |  |                                    | YFZ 350 U/A/B/D/E/F/G/H/J/K/<br>L/M/N/P/R/S/T/V |                |
| CK2221              | No fitment  |  |                                    | DT 400  | 90-06          |
|                     |   |  |                                    | RD 400 C-F                                      | 75-76<br>76-79 |
| CK2222              | Use CK2240  |  | CK2241                             | Use CK2267                                      |                |
| CK2223              | DT 250 MX   | 77-80  | CK2242                             | XS 650  | 80-81          |
|                     |   |  |                                    | XS 650 SE                                       | 79-81          |
| CK2224              | No fitment  |  | CK2243                             | Use CK2238                                      |                |
| CK2225              | Use CK2209  |  | CK2244                             | YZ 250 G  | 80             |
| CK2226              | XS 650<br>YZF R1  | 75-79<br>98  |                                    | YZ 250 D/E                                      | 77-78          |
|                     |   |  | CK2245                             | DT 175 MX                                       | 78-81          |
| CK2227              | Use CK2255  |  | CK2246                             | Use CK2240                                      |                |
| CK2228              | Use CK2296  |  | CK2247                             | Use CK2273                                      |                |
| CK2229              | Use CK2234  |  | CK2248                             | Use CK2269                                      |                |
| CK2230              | XS 1100 S/1100  | 78-81  | CK2249                             | No fitment                                      |                |
|                     |   |  | CK2250                             | IT 250 G  | 80             |
| XS 250 SE/C         | 80-81   |  |                                    |   |                |
| YZ 250 F            | 79  |  |                                    |   |                |
| XVS 250 Dragstar    | 01-03   |  |                                    |   |                |
| CK2231              | Use CK2303  |  | CK2251                             | No fitment                                      |                |
|                     |   |  | CK2252                             | No fitment                                      |                |
|                     |   |  | CK2253                             | Use CK2254                                      |                |
|                     |   |  | CK2254                             | YZ 80 E/F                                       | 78-79          |
|                     |   |  |                                    | RS 100/RS 100 'S'                               | 77-78          |
|                     |   |  |                                    | RS 100/RS 100 DX                                | 79             |
|                     |   |  |                                    | RS 100  | 80-81          |
|                     |   |  | RT 100 E/F/K                       | 93-03   |                |
| CK2232              | No fitment  |  | CK2255                             | IT 125 G/H/J                                    | 80-82          |
|                     |   |  |                                    | TY 125  | 80-82          |
| CK2233              | No fitment  |  | YZ 125 C                           | 76  |                |
|                     |   |  | YZ 125 F/G                         | 79-80   |                |
| CK2234              | YZ 100 E/F/G/H/K<br>IT 125 G/H/J<br>TY 125<br>YZ 125 C<br>YZ 125 F/G<br>TY 175<br>TW 200 (2JL/4CS1/2/3/4/5/6/5LB1/2)<br>TT 225<br>TW 225 E (5VC1/2) | 78-83<br>80-82<br>80-82<br>76<br>79-80<br>77-80<br>01-02<br>03 | TY 175                             | 77-80   |                |
|                     |   |  | TW 200 (2JL/4CS1/2/3/4/5/6/5LB1/2) | 01-02   |                |
|                     |   |  | TT 225                             | 77-80   |                |
|                     |   |  | TW 225 E (5VC1/2)                  | 03  |                |
|                     |   |  |                                    |   |                |

| Part No.         | Make/Model   | Year       | Part No.   | Make/Model                         | Year       |            |            |   |  |  |                                |                      |   |         |
|------------------|--|------------|------------|------------------------------------|------------|------------|------------|---|--|--|--------------------------------|----------------------|---|---------|
| CK2254<br>Contd. | <b><u>YAMAHA Cont.</u></b>   |            | CK2274     | <b><u>YAMAHA Cont.</u></b>         |            |            |            |   |  |  |                                |                      |   |         |
|                  | RXS 100  | 83-97      |            | WR 250 ZF/ZG/ZH/ZJ/EK              | 94-98      |            |            |   |  |  |                                |                      |   |         |
|                  | RX 115 (5FS3)  | 99         |            | YZ 250 E/F/G/H/J/L/M/N/P/R/S/T/V/W | 93-07      |            |            |   |  |  |                                |                      |   |         |
|                  | RD 125 DX  | 78-81      |            | WR 450 FT/FV/FW                    | 05-07      |            |            |   |  |  |                                |                      |   |         |
|                  | RS 125   | 77-81      |            | YZ 450 FW                          | 07         |            |            |   |  |  |                                |                      |   |         |
|                  | TT-R 125 M/LWM/N/LWN/LWP/P/R/LWR<br>/T/ET/LWET/LWT/LV/LEV/EV/EW/LWEW | 00-07      |            | XV 750 SE                          | 81         |            |            |   |  |  |                                |                      |   |         |
|                  | XT 125 R   | 05-07      |            | XV 750 Virago                      | 92-97      |            |            |   |  |  |                                |                      |   |         |
|                  | XT 125 R   | 05-07      |            | XV 1000/TR1                        | 81-86      |            |            |   |  |  |                                |                      |   |         |
|                  | XTZ 125 K/K  | 05-06      |            | BT 1100 P/R/S/T/V "Bulldog"        | 02-06      |            |            |   |  |  |                                |                      |   |         |
|                  |  |            |            | XV 1100 Virago                     | 89-00      |            |            |   |  |  |                                |                      |   |         |
| CK2255           | FZ 400 N (1FK 46X 33M)   | 85-        | CK2275     | Use CK2279                         |            |            |            |   |  |  |                                |                      |   |         |
|                  | XJR 400  | 93-99      |            | CK2276                             | YZ 125 J   | 82         |            |   |  |  |                                |                      |   |         |
|                  | XS 500 B/C/D   | 78-79      |            |                                    | CK2277     | Use CK2278 |            |   |  |  |                                |                      |   |         |
|                  | FZ 600   | 87-88      |            |                                    |            | CK2278     | YZ 125 K-T | 83-87   |  |  |                                |                      |   |         |
|                  | FZ 6 Fazer/Fazer A   | 04-07      |            |                                    |            |            | CK2279     | YZ 250 H  | 81   |  |                                |                      |   |         |
|                  | FZ 6 Naked Version   | 04-07      |            |                                    |            |            |            | XS 250 C/D/E  | 78-80  |  |                                |                      |   |         |
|                  | FZ6 S2 ABS (Naked)   | 07         |            |                                    |            |            |            | XS 400  | 78-79  |  |                                |                      |   |         |
|                  | FZ6 Fazer S2 (ABS)   | 07         |            |                                    |            |            |            | XS 400 SE   | 80   |  |                                |                      |   |         |
|                  | XJ 600   | 84-92      |            |                                    |            |            |            | YZ 400 D-F  | 77-79  |  |                                |                      |   |         |
|                  | XJ 650   | 80-84      |            |                                    |            |            |            | IT 425 G  | 80   |  |                                |                      |   |         |
|                  | XJ 650 Turbo   | 82         |            |                                    |            |            |            | IT 465 H/J  | 81-82  |  |                                |                      |   |         |
|                  | XJ 600 S/N Diversion   | 92-03      |            |                                    |            |            |            | YZ 465 G/H  | 80-81  |  |                                |                      |   |         |
|                  | YX 600 S/SC/T/TC/UC/U/W/WC/A/AC 'Radian'                             | 86-90      |            |                                    |            |            |            | XS 750  | 77-79  |  |                                |                      |   |         |
|                  | YZF R6   | 99-05      |            |                                    |            |            |            | XS 750 SE   | 79-80  |  |                                |                      |   |         |
|                  | YZF R6S  | 07         |            |                                    |            |            |            | IT 250 H/J  | 81-82  |  |                                |                      |   |         |
|                  | XJ 650 G/H/J/K 'Maxim'   | 80-83      |            |                                    |            |            |            | CK2280  | IT 250 L                                       | 84                                     |                                |                      |   |         |
|                  | XJ 650 LH 'Midnight'   | 81         |            |                                    |            |            |            |   | YZ 250 J-T                                     | 82-87                                  |                                |                      |   |         |
|                  | XJ 650 RJ/LK Seca  | 82-83      |            |                                    |            |            |            |   | YTZ 250 N/S                                    | 85-86                                  |                                |                      |   |         |
|                  | FZX 700 S/SC/T/TC 'Fazer'  | 86-87      |            |                                    |            |            |            |   | IT 490 L                                       | 84                                     |                                |                      |   |         |
|                  | FZ 750   | 85-86      |            |                                    |            |            |            |   | YZ 490 J-U                                     | 82-88                                  |                                |                      |   |         |
|                  | XJ 750   | 82-83      |            |                                    |            |            |            |   | WR 500 ZD                                      | 92-93                                  |                                |                      |   |         |
|                  | XJ 750 RF/RJ/RK 'Seca'   | 81-83      |            |                                    |            |            |            |   | CK2281   | DT 125 LC<br>(Type 10V/12W/26G)        | 82-83                          |                      |   |         |
|                  | XTZ 750  | 89-95      |            |                                    |            |            |            |   |  | CK2282                                 | Use CK2299                     |                      |   |         |
|                  | TDM 850  | 91-95      |            |                                    |            |            |            |   |  |  | CK2283                         | DT 125 LC (Type 35A) | 85-87   |         |
|                  | XJ 900/900 F   | 83-92      |            |                                    |            |            |            |   |  |  |                                | DT 125 (3TT4)        | 96  |         |
|                  | XJ 900 S Diversion   | 95-03      |            |                                    |            |            |            | RD 125 LC Mk1 - 3                                     |  |  |                                | 82-87                |   |         |
|                  | CK2256   | SR 125 SE  |            |                                    |            |            |            | 81-83   |  |  |                                | RZ 125 (1GV 030101-) | 85  |         |
|                  |  | SR 125     |            |                                    |            |            |            | 89-03   |  |  |                                | RX 135 (13X)         | 81  |         |
|                  |  | TW 125     |            |                                    |            |            |            | 99-03   |  |  |                                | CK2284               | Use CK2255  |         |
|                  |  | XT 125     |            |                                    |            |            |            | 82-83   |  |  |                                |                      | CK2285  | FJ 1100 |
| CK2257           |  | Use CK2310 |            |                                    |            |            |            | XJR 1200  |  |  |                                |                      |   | 95-98   |
|                  |  | CK2258     | Use CK2264 |                                    |            |            |            | FJ 1200/1200 A  | 86-95  |  |                                |                      |   |         |
|                  |  |            | CK2259     | Use CK2208                         |            |            |            | XJR 1300 L 5EA2/5EA3/5EA4                             | 99   |  |                                |                      |   |         |
|                  |  |            |            | CK2260                             | No fitment |            |            | XJR 1300 M 5EAA/5EAB/5EAC                             | 00   |  |                                |                      |   |         |
|                  |  |            |            |                                    | CK2261     | SR 250 SE  | 81-82      | XJR 1300 (5EA1/5EA7)                                  | 98-99  |  |                                |                      |   |         |
|                  |  |            |            |                                    |            | SRX 250    |            | XJR 1300 (5EA9/5EAG)                                  | 00   |  |                                |                      |   |         |
|                  | CK2262   |            |            |                                    |            | XS 400     | 82         | XJR 1300 N/P (5EAP/5EAR/5EAS<br>/5EAT/5EAW/5EAV/5EAY) | 01-02  |  |                                |                      |   |         |
|                  |  |            |            |                                    |            | CK2263     | No fitment |   | XJR 1300 R/S 5WM1/5WM3<br>/5WM5/5WM6/5WM7/5WM9 | 03-04                                  |                                |                      |   |         |
|                  |  |            |            |                                    |            |            | CK2264     | No fitment  |  | XJR 1300 T/V/W 5WMA/5WMC<br>/5WMD/5WMF | 05-07                          |                      |   |         |
|                  |  |            |            |                                    |            |            |            | CK2265  | No fitment                                     |  | XJR 1300 SP (L) 5EA5/5EA6/5EA8 | 99                   |   |         |
| CK2266           |  |            |            |                                    |            |            |            |   | Use CK2287                                     |  | XJR 1300 SP (M) 5EAD/5EAE/5EAF | 00                   |   |         |
|                  |  | CK2267     |            |                                    |            |            |            |   | XT 250   | 80                                     | XJR 1300 SP (N) 5EAL/5EAM/5EAN | 01                   |   |         |
|                  |  |            | SR 250     |                                    |            |            |            |   | 80   | CK2286                                 | No fitment                     |                      |   |         |
|                  |  |            | CK2268     | Use CK2255                         |            |            |            |   |  |  | CK2287                         | YZ 80 H/J/K/L/N      | 81-85   |         |
|                  |  |            |            | CK2269                             | USE CK2306 |            |            |   |  |  |                                | YTM 225 DRN          | 85  |         |
|                  |  |            |            |                                    | CK2270     |            |            |   | Use CK2230                                     |  |                                |                      | YFM 200 DKW/DX/DXA                                    | 86-90   |
|                  | CK2271   |            |            |                                    |            |            |            |   | Use CK2285                                     |  |                                |                      | YFM 225 N/S/T/U                                       | 85-89   |
|                  |  |            |            |                                    |            | CK2272     |            |   | Use CK2274                                     |  |                                |                      | YFB 250 D/E/F/G/H/J/K/FWF/FWG/<br>FWH/FWJ/FWK/FWL/FWM | 92-00   |
|                  |  |            |            |                                    |            |            | CK2273     |   | XS 850   |  |                                | 80                   |   |         |

| Part No.         | Make/Model   | Year   | Part No. | Make/Model  | Year   |
|------------------|--|--|----------|---|--|
| CK2287<br>Contd. | <b>YAMAHA Cont.</b><br>YFM 250 W/A/B<br>YFM 250 XN/XP/XR "Bear Tracker"<br>YFM 250 FN<br>YFM 250 BT/BV (Bruin)<br>YFM 250 BW Big Bear<br>YFUJW   | 90-92<br>99-03<br>01<br>05-06<br>07<br>89-90   | CK2303   | <b>YAMAHA Cont.</b><br>V 50 M/P<br>YFM 50 S/T/RV Raptor<br>YFM 80 D/E/F/G/H/J/K/L/M/N Badger<br>YFM 80 WP/WR/WS/WT/RV/RW Raptor<br>YFM 80 GT/GV/GW Grizzly<br>T 80<br>PW 80 All models<br>V 80  | 75-77<br>04-06<br>91-01<br>02-07<br>05-07<br>83-97<br>83-05<br>79-85                               |
| CK2288           | No fitment   |  |          |   |  |
| CK2289           | Use CK2303   |  | CK2304   | YZ 80 S/T/U/W/E/LC/LW/F<br>TZR 125<br>YTM 200 EL/DX   | 86-94<br>87-93<br>89   |
| CK2290           | YFM 350 FWT/FWU/FWW/FWA/<br>FWE Big Bear<br>YFM 350 FWF/FWG/FWH/FWJ<br>YFM 350 ERD/ERE/ERF/ERG<br>YFM 350 XD/XE/XF/XG/XH/XJ/XK/XL/XM/XN/XP/XR<br>YFM 350 S/T/V/R-WV/RW Raptor<br>YFM 350 UH/UJ<br>DT 400 MX<br>YFM 400 FWE/WW/FWG/FWH<br>/FWJ/FWK/FWL/FWM Kodiak<br>YFM 400 FPR  | 86-93<br>94-97<br>92-95<br>92-03<br>04-07<br>96-97<br>77-79<br>93-00<br>03   | CK2305   | RD 500 LC   | 84-86  |
| CK2291           | Use CK2303   |  | CK2306   | FZ 750<br>FZX 750   | 87-92<br>87  |
| CK2292           | AG 200 E (3GX6)  | 93   | CK2307   | Use CK2319  |  |
| CK2293           | Use CK2261   |  | CK2308   | FZR 750<br>FZR 1000   | 87<br>87-88  |
| CK2294           | Use CK2240   |  | CK2309   | WR 250 ZB/ZD/ZE<br>YZ 250 U/W/A/B/D<br>YZ 250 WRW/WRA<br>XVS 650 Dragstar<br>XVS 650 A Dragstar Classic   | 91-93<br>88-92<br>89-90<br>97-03<br>98-07  |
| CK2295           | TY 250 S/R   | 84-92  | CK2310   | YZ 400 FK/FL<br>WR 400 FK/FL/FM<br>XT 550   | 98-99<br>98-00<br>82   |
| CK2296           | SR 400<br>SR 500<br>SR 500 S (3GWS)<br>ST 500 (3GW1/3/4/6/7)<br>TT 500 G/H<br>XT 500<br>XZ 550   | 88<br>78-82<br>98<br>96-98<br>80-81<br>77-81<br>82   | CK2311   | YZ 125 W/A  | 89-90  |
| CK2297           | SRX 400 (1JL)<br>SRX 400 (3VN1/3VN2/3VN5)<br>XT 550<br>SRX 600<br>SRX 600 (1JK/3SX)<br>TT 600 L<br>TT 600 W (59X/2JT/3SW1)<br>TT 600 K<br>TT 600 E<br>TT 600 R (5CH1)<br>TT 600 R (5CH2)<br>TT 600 R (5CH3)<br>TT 600 RE (5CH5)<br>XT 600<br>XT 600 Z/E/ZE<br>SZR 660<br>YFM 660 RN/RP/RR/RS/RT Raptor<br>XTZ 660 "Tenere"<br><b>DERBI</b><br>Mulhacen 659 | 90-96<br>83<br>86-87<br>85-91<br>84<br>89-92<br>93-96<br>94-95<br>97<br>98-99<br>00-02<br>04<br>84-87<br>84-03<br>96-97<br>01-05<br>91-97<br>06-07 | CK2312   | YZ 125 U  | 88   |
| CK2298           | No fitment   |  | CK2313   | DT 125 R<br>DT 125 X<br>DT 125 RE<br>TDR 125 (3HS/3XD1)<br>TDR 125<br>TZR 125 R/RR<br>TZR 150 R (4AP20)<br>DT 200 (2LR)<br>DT 200 WR 3XP<br>SDR 200<br>YFS 200 B/F/G/H/J/K/L/M/N/P<br>/R/S/T/V 'Blaster'<br>WR 200 D/E/F<br>DT 230 (4TP1/2) Lanza | 88-03<br>05-06<br>04-07<br>89-93<br>93-03<br>93-95<br>00<br>87<br>92-93<br>91-06<br>92-94<br>97-98 |
| CK2299           | XVS 400<br>XV 535/535 S "Virago"   | 96<br>88-03  | CK2314   | No fitment  |  |
| CK2300           | XVZ 12 TD<br>V-Max All models<br>XVZ 13 Royal Star All models  | 85<br>91-03<br>96-01   | CK2315   | FZR 400 RSP (2TK-EXUP)<br>FZR 400 RRSP (3TJ2/6/7)<br>FZR 600  | 87<br>89-93  |
| CK2301           | Use CK2240   |  | CK2316   | XV 125 Virago<br>XVS 125 Dragstar<br>SRV 250 'Soulful Twin/Renaissa'<br>XV 250 Virago<br>XV 250 S "Virago"  | 97-02<br>00-03<br>96-97<br>89-94<br>95-00  |
| CK2302           | T 50   | 86   | CK2317   | FZR 400 RR<br>FZR 400 Genesis (1WG)<br>FZR 400 (3EN1/3EN2)<br>FZR 400 RR (3TJ1)   | 92<br>86<br>88-89  |
|                  |  |  | CK2318   | YZF R6<br>FZR 750 R OWOI<br>YZF 750 R/SP<br>TDM 850<br>TRX 850<br>TDM 900 P/R/S/T/V<br>TDM 900 AT/AV/AW   | 06-07<br>89-90<br>93-97<br>96-01<br>96-98<br>02-06<br>05-07  |

| Part No. | Make/Model  | Year  | Part No. | Make/Model  | Year   |
|----------|---|---|----------|---|--|
| CK2319   | <b>YAMAHA Cont.</b><br>YZ 125 B/D<br>TDR 250<br>TTR 250 M/N/P<br>TYZ 250 R<br>TZR 250<br>TZR 250 R (3XV1/4/6)<br>R1Z 350                                  | 91-92<br>88-92<br>00-02<br>93-96<br>87-92<br>91<br>92 | CK2355   | <b>YAMAHA Cont.</b><br>YZ 250 FN/FP/FR/FT/FV/FW<br>WR 250 FN/FP/FR/FT/FV/FW                               | 01-07<br>01-07   |
| CK2321   | FZR 1000  | 89-92   | CK2356   | YZ 426 FN/FP<br>WR 426 FN/FP<br>WR 450 FR/FS<br>YZF R1<br>YZF R1SP<br>FZ1<br>FZ1 Fazer                    | 01-02<br>01-02<br>03-04<br>04-07<br>06<br>06-07<br>06-07 |
| CK2324   | XT 225 Serrow 'All models'<br>ST 225 (5BT) Bronco   | 97  | CK2358   | FZS 1000 Fazer  | 01-05  |
| CK2325   | YZ 125 E/F/G/H/J/K/L/M/N/P/R/S/T/V/W  | 93-07   | CK2362   | FJR 1300 N/P/R/AR/S/AS/AT/AV/<br>ASV/AW/ASW<br>XVS 1300 A Midnight Star                                   | 01-07<br>07  |
| CK2326   | Use CK2318  |   | CK2363   | XV 1700 PCR   | 03-05  |
| CK2327   | GTS 1000<br>FZR 1000<br>YZF 1000 Thunder Ace  | 93-96<br>93-95<br>96-02                               | CK2364   | YFZ 450 S/T/V/W<br>YFM 700 RV/RW Raptor<br>YFZ 450 V  | 04-07<br>06-07<br>06                                     |
| CK2329   | Use CK2304  |   | CK2365   | DT 175 (3TS4)   | 96   |
| CK2331   | FZR 250<br>FZR 250 R<br>FZX 250 Zeal (3YX1/2/4)   | 87<br>91-92   | CK2366   | MT-01 (1670cc)  | 05-07  |
| CK2332   | FZR 600 R<br>YZF 600 Thunder Cat  | 94-95<br>96-03  | CK2367   | XV 1900 A   | 06   |
| CK2334   | XT 500 C  | 76  | CK2368   | XT 660 R<br>XT 660 X<br>MT 03<br><b>Aprilia</b> 650 PegasoTrail   | 04-07<br>04-07<br>06-07<br>05-06                         |
| CK2335   | YZ 80 G/H/J/K/L/M/N<br>YZ 85 P/LWP/R/LWR/S/LWS/T/LWT<br>V/LWV/LWW/W   | 95-01<br>02-07  | CK3301   | <b>SUZUKI</b><br>No fitment   |  |
| CK2336   | SR 250  | 93-94   | CK3302   | No fitment  |  |
| CK2337   | Serrow 250 (3C51/52)<br>TT 250 R<br>XG 250 Tricker (5XT1)   | 05<br>96<br>04-06                                     | CK3303   | No fitment  |  |
| CK2339   | Use CK2300  |   | CK3304   | No fitment  |  |
| CK2342   | TZR 250 (3MA1/3/5)  | 89-90   | CK3305   | No fitment  |  |
| CK2343   | Not available   |   | CK3306   | B 120<br>T 125/T 125 -11/R 'Stinger'  | 69-71  |
| CK2344   | Not available   |   | CK3307   | No fitment  |  |
| CK2346   | Use CK2310  |   | CK3308   | Use CK3318  |  |
| CK2347   | FZS 600 Fazer   | 98-03   | CK3309   | Use CK3319  |  |
| CK2348   | DT 50 R<br>DT 50 X Supermotard  | 97-07<br>04-07  | CK3310   | T 20 Super Six  | 66-68  |
| CK2349   | TZR 50 (5DU1/3)<br>TZR 50 (5WX1)  | 97-00<br>03-07  | CK3311   | AP 50   | -78  |
| CK2350   | YZF R1  | 99-03   | CK3312   | A 100 L/M/N   | 74-80  |
| CK2351   | XV 1600 A   | 99-03   | CK3313   | T 250 II/R/J<br>T 350 1/2/R/J   | 70-72<br>69-72   |
| CK2352   | YZ 426 FM<br>YZ 450 FR/FS/FT/FV   | 00<br>03-06   | CK3314   | T 500 1/2/3 (18 ears)   | 68-70  |
| CK2353   | YZF R7  | 99-00   | CK3315   | TS 250 K-M/A-C<br>TS 250 ERN/ERT/ERX<br>GT 250M/A/B/C<br>GT 380 K-M/A/B<br>RM 400 C<br>GT 250 X7 EN/ET/EX | 73-78<br>79-81<br>75-78<br>73-77<br>78<br>79-81          |
| CK2354   | TT-R 90 M/N/P/R/ES/S/ET/T/EV/EW<br>T 90 N/D (4NM1-9) Mate<br>T 105/105 E Crypton<br>V 110 ZE/ZK/ZHE/ZHK<br>FIZR/FIZR Sporty<br>T 105 E (5ER1/2) Crypton-R | 00-07<br>00-<br>96<br>96<br>99                        | CK3316   | GT 500 A/B<br>T 500 R/J/K/L/M (12 ears)   | 76-77<br>71-75   |
|          |   |   | CK3317   | Use CK3393  |  |

| Part No.                                       | Make/Model                                 | Year                | Part No.                         | Make/Model                                 | Year  |                       |   |
|--|--|---------------------|----------------------------------|--|---|-----------------------|---|
| CK3318   | <b>SUZUKI Cont.</b>                        |                     | CK3326                           | <b>SUZUKI Cont.</b>                        |   |                       |   |
|  | RM 80 C/XT/XX/M                            | 78-81               |                                  | TS 100 K/L/M/A/B                           | 73-77   |                       |   |
|  | RM 80 XE/XF/HF                             | 84-85               |                                  | CK3327                                     | Use CK3345  |                       |   |
|  | RM 80 K/L/M/N/P/R/S/T/V/W/X/Y/K1           | 89-01               |                                  |  | CK3328  | ZR 50 SKE/SKH         | 84-87                                   |
|  | RM 85 K2/LK2/K3/LK3/K4/LK4                 | 02-04               |                                  | GS 50 K5 (NA41A)                           |   | 05                    |   |
|  | RM 85 K5/LK5/K6/LK6/K7/LK7                 | 05-07               |                                  | GT 50 KB/KEN                               |   | 77-80                 |   |
|  | TS 100 C                                   | 78                  |                                  | OR 50 ET                                   |   | 80                    |   |
|  | TS 100 ERN                                 |                     |                                  | RM 50 C/N/T/X/Z                            |   | 78-82                 |   |
|  | (Up to E/No 300563)                        | 79                  |                                  | TS 50 KN/ERKT/ERKX/ERKZ/ERKD               |   | 79-83                 |   |
|  | TS 100 ERZ/ERH                             | 82                  |                                  | ZR 50 KEN/KEX/SLKX/SKX                     |   | 79-81                 |   |
|  | DF 125                                     |                     |                                  | LT 125 D/E/F/G/H                           |   | 84-86                 |   |
|  | DR 125 SZ/SD/SE/SF/SH/SJ                   | 82-94               |                                  | LT 185 E/F                                 |   | 84-85                 |   |
|  | DR-Z 125 K3/K4/K5/K6/K7                    | 03-07               |                                  | CK3329                                     |   | RM 100 B/C            | 77-78                                   |
|  | DR-Z 125 LK3/LK4/LK5/LK6/LK7               | 03-07               |                                  |  | RM 125 A/B/C  | 76-78                 |   |
|  | FX 125                                     |                     |                                  |  | RM 125 X/Z/D  | 81-83                 |   |
|  | GN 125 Z/M/R/V/W/X/Y/K1                    | 94-01               |                                  |  | RM 125 F  | 85                    |   |
|  | GS 125 Z/D/ESZ/ESD/ESF/ESK/<br>ESM/ESR/ESX | 82-00               |                                  |  | PE 175 C/N/T/X/Z  | 78-82                 |   |
|  | GT 125 L/M/A/B/C/EC                        | 74-80               |                                  |  | TS 200 RK/RL/RM/RN/RP/R   | 89-94                 |   |
|  | GZ 125 W/X/Y/K1-K7                         | 98-07               |                                  |  | GSX 250 ET/EX/EZ  | 80-82                 |   |
|  | RV 125 K2-K7 Van-Van                       | 02-07               |                                  |  | GS 250 TT/TX  | 80-81                 |   |
|  | TF 125 Farm Bike (All models)              | 78-05               |                                  |  | CK3330  | GS 650 GX/GZ 'Katana' | 81-82                                   |
|  | TS 125 ERZ                                 | 82                  |                                  |  |   | GS 650 GTX/GTZ/GTD    | 81-83                                   |
|  | TS 125 K/L/M/A/B/C/C2                      | 73-78               |                                  | GS 700 EF/ESF                              |   | 85                    |   |
|  | TS 125 ERN                                 |                     |                                  | GSX 750 ET/EX/ESD/EFE/ESG/ESE/FFF          |   | 80-86                 |   |
|  | (Up to E/No.: - 302345)                    | 79                  |                                  | GSX 750 SE 'Katana'                        |   | 84                    |   |
|  | TS 125 N (Up to F/No 178871)               | 84                  |                                  | GSX 750 S/SS Katana<br>(GS75X-106815-)     |   | 84                    |   |
|  | DR 125 SEX/SEY                             | 99-01               |                                  | GSX 750 S-2/S-2C<br>(GS75X-114747-) Katana |   | 84                    |   |
| DF 200 EV/EW/EY (SH42A)                        |  | GS 850 (all models) | 79-85                            |  |   |                       |   |
| DR 200 SEP/SER/SES/SEV/SEW<br>/SEX/SEY (SH42A) |  | CK3331              | PE 250 T/X/Z                     | 80-82                                      |   |                       |   |
| RV 200 K2/K3                                   | 02-03                                      |                     | RM 250 N/T/X/Z/D/E/F             | 79-85                                      |   |                       |   |
| <b>KAWASAKI</b>                                |  | CK3332              | RG 250 WD                        | 83   |   |                       |   |
| KLX 125 A1/A2/A3/A6F                           | 03-06                                      |                     | DR 400 ST/SX                     | 80-81                                      |   |                       |   |
| KLX 125 L (B1/B2/B3/B6F)                       | 03-06                                      |                     | GN 400 TT                        | 80   |   |                       |   |
| <b>SACHS</b>                                   |  |                     | GSX 400 FEX/FZ/FD                | 81-83                                      |   |                       |   |
| XTC 125  | 00-07                                      |                     | GSX 400 FW/FWS/FWS-2             |  |   |                       |   |
| X Road 125                                     | 06-07                                      |                     | PE 400 T/X                       | 80-81                                      |   |                       |   |
| CK3319   | GP 100 N/UN                                |                     | 79                               | RM 400 N/T                                 | 79-80   |                       |   |
|  | GP 100 C/UC                                |                     | 78                               | SP 400 T                                   | 80  |                       |   |
|  | RM 100 A                                   |                     | 76                               | CK3333                                     | GSX 400 ET/EX/EZ  | 80-82                 |   |
|  | RM 100 N/T/X                               |                     | 79-81                            |  | GSX 400 TX/LX   | 81                    |   |
|  | GP 125 C/N                                 |                     | 78-79                            |  | GS 450 ET/EG/EJ   | 80-88                 |   |
|  | RG 125 (all models)                        |                     | 85-96                            |  | GS 500 EK/EL/EM/EN/EP/ER/ES<br>/ET/EV/EW/EX/EY/K1/K2/K3/K4<br>/FK4/FK5/K5/FK6/K6/FK7/K7 | 89-07                 |   |
|  | RM 125 N/T                                 |                     | 79-80                            |  | RGV 250 M/N/P/R   | 91-96                 |   |
|  | RM 125 G/H                                 |                     | 86-87                            |  | <b>APRILIA</b>  |                       |   |
|  | TS 125 X (all models)                      |                     | 84-90                            |  | RS 250  | 95-02                 |   |
|  | TS 125 RK/RL/RM/RN/RP/RR                   |                     | 90-94                            |  | CK3334  | RM 250 A-C            | 76-78                                   |
|  | TS 250 XE/XG/XH/XJ/XK                      |                     | 85-89                            |  |   | SP 370 C/N            | 78-79                                   |
|  | GT 185 (all models)                        |                     | 73-82                            |  | PE 250 B/C/N  | 77-79                 |   |
|  | TS 185 K/L/M/B/C/ERN/ERT/ERX               |                     | 73-81                            | CK3335                                     | GS 1000 GT/GX   | 80-81                 |   |
|  | DR 200 G/H/J                               |                     | 86-89                            |  | GSX 1000 SZ   | 82                    |   |
|  | DR 200 SE Trojan                           |                     |                                  |  | GS 1100 GZ  | 82                    |   |
|  | DR 200 SEK1-SEK6                           |                     | 01-05                            |  | GSX 1100 ET/EX/EZ/SZ  | 80-82                 |   |
|  | GT 200 EN/EX 'X5'                          |                     | 79-80                            |  | GSX 1100 EFE/EFG/ESF  | 84-86                 |   |
|  | SB 200 N/X                                 |                     | 79-80                            |  | VL 1500 W/X/Y/K1/K2/K3  | 98-03                 |   |
|  | SX 200 R/R-Z/RJ/RM                         |                     | 90-91                            |  | VL 1500 K5/K6/K7 (C 1500 Intruder)  | 05-07                 |   |
|  | GSF 250 N/ZM/P/NP/ZP/N/NR                  |                     | 92-96                            |  | CK3336  | Use CK3348            |   |
|  | GSX 250 R CH/H (GJ72A)                     |                     |                                  |  |   | CK3337                | TS 100 ERN/ERT/ERX<br>(From F/No300564) |
|  | GSXR 250 J (GJ72A)                         |                     | TS 125 ERN<br>(From F/No 302346) |  | 79  |                       |   |
|  | GSXR 250 CK                                |                     | TS 125 N (From F/No 178872)      | 84   |   |                       |   |
|  | <b>SACHS</b>                               |                     | TS 125 ERT/ERX                   | 80-81                                      |   |                       |   |
|  | XTC 125                                    | 00-04               | GT 125 EN                        | 81   |   |                       |   |
|  | CK3320                                     | Use CK3324          |                                  |  |   |                       |   |
|  | CK3321                                     | GT 550 K/L/M/A/B    | 73-77                            |  |   |                       |   |
| CK3322   | Use CK3343                                 |                     |                                  |  |   |                       |   |
| CK3323   | Use CK3344                                 |                     |                                  |  |   |                       |   |
| CK3324   | GT 750 K/L/M/A/B<br>GS 750 B/DB/DC/EC/EN   | 73-77<br>77-79      |                                  |  |   |                       |   |
| CK3325   | No fitment                                 |                     |                                  |  |   |                       |   |

| Part No. | Make/Model   | Year  | Part No. | Make/Model   | Year   |
|----------|--|---|----------|--|--|
| CK3338   | <b>SUZUKI Cont.</b><br>GP 125 X/XD   | 81-84   | CK3359   | <b>SUZUKI Cont.</b><br>GSX 400 FSV/FSK1 (GK7B) Inazuma<br>DR 500 X/Z/D<br>DR 600 RG/RH/SF/SG/SH<br>LS 650 'Savage' FG/PK/PM/PR/<br>PS/PT/PV  | 00<br>81-83<br>85-87<br>87-97  |
| CK3339   | GP 100 X/UX/D/UD/UL<br>GSXR 250 RK (GJ73A)<br>GSX 250 SSM Katana (GJ76A)   | 81-92<br>91   | CK3360   | Use CK3390   |  |
| CK3340   | DS 80 T/X/Z/D/F/G/H/J/K/L/M/N<br>/P/R/S/T/V/W/X/Y<br>JR 80 K1/K2/K3/K4/K5/K6/K7<br>RM 80 XZ/XD/HD  | 80-00<br>01-07<br>82-83                                     | CK3361   | Use CK3364   |  |
| CK3341   | Use CK3340   |   | CK3362   | Use CK3364   |  |
| CK3342   | Use CK3328   |   | CK3363   | Use CK3319   |  |
| CK3343   | GS 400 B/C<br>GS 425 EN  | 77-78<br>79   | CK3364   | LT 160 EK/EL/EM/EN<br>LT-F 160 L/M/N/P/R/S/T/V/W<br>/X/Y/K1/K2/K3<br>LT 160 K3/K4 QuadSport<br>LT 230 GEF/GEG<br>LT-F 230 G/H<br>LT-F 250 K2 Ozark   | 89-92<br>90-03<br>03-04<br>85-86<br>86-87<br>02                                      |
| CK3344   | GS 550 (all models)<br>GSX 550 (all models)  | 77-82<br>84-87  | CK3365   | Use CK3319   |  |
| CK3345   | GS 1000 HC/EC/EN/SN/ET   | 78-80   | CK3366   | JR 50 (All models)<br>KDX 50 A1/A2/A3/A6F  | 78-07<br>03-06   |
| CK3346   | GSX 1100 SD/ESD  | 83  | CK3367   | RM 80 XG/XH/XJ   | 86-88  |
| CK3347   | XN 85 D 'Turbo'<br>KSF 400 A3 (KFX 400)  | 83<br>05  | CK3368   | Use CK3318   |  |
| CK3348   | RM 465 X/Z<br>RM 500 D<br>GSF 600 S/T/ST/V/SV/W/SW/X/SX<br>/SY/Y/SK1/K1/K2/SK2/K3/SK3<br>/K4/SK4<br>GSX R 750 F/G/H<br>GSX 600 FJ/FK/FL/FM   | 81-82<br>83<br>95-04<br>85-87<br>88-91                      | CK3369   | Use CK3318   |  |
| CK3349   | TS 50 X (all models)<br>RG 50 EW   | 84-02   | CK3370   | Use CK3329   |  |
| CK3350   | Use CK3315   |   | CK3371   | Use CK3319   |  |
| CK3351   | RG 250 WE/FG/FH/CH/FCH<br>RGV 250 J<br>RGV 250 K/L<br>TV 250 J/K/AK/L (VJ21A) Wolf   | 84-88<br>88<br>89-90<br>88-90                               | CK3372   | LT 250 RH/RJ/RK<br>RM 250 G/H  | 86-90<br>86-87   |
| CK3352   | Use CK3351   |   | CK3373   | RE5M/A   | 75-76  |
| CK3353   | Use CK4503   |   | CK3374   | RM 250 J/K/L/M<br>RMX 250 K/L<br>RMX 250 M<br>RMX 250 R/S/T/V/W<br>RMX 250 ST/SV/SW/SX (SJ14A)<br>RM 250 R/S<br>LT 500 RL/RM   | 88-91<br>89-90<br>91<br>94-98<br>96-99<br>94-95<br>90-91                             |
| CK3354   | No fitment   |   | CK3375   | GV 1200 GLF/GLF2/GLG 'Madura'  | 85-86  |
| CK3355   | No fitment   |   | CK3376   | No fitment   |  |
| CK3356   | RM 125 E<br>RM 125 J/K/L/M<br>LT-F 300 FX/FY/FK1   | 84<br>88-91<br>99-01  | CK3377   | VS 400 VR/FR/VTR/FTR/VT/FT 'Intruder'<br>VS 600 GLS/GLT<br>SV 650 X/SX/Y/SY/K1/SK1/SK2<br>VS 700 'All models'<br>VS 750 GLF/GLFG/GLFH/GLPG/<br>GLEFH/GLEPH/GLPK/GLPM<br>VL 800 K1/K2/K3/K4/K5/K6/K7<br>VX 800 L/M/N/P/R<br>VS 800 GLN/GLP/GLR/GLS/GLT/GLV<br>VZ 800 V/W/X/Y/K1/K2 Marauder<br>VZ 800 K5-K7 Intruder M800 | 94-<br>95-96<br>99-02<br>86-87<br>85-91<br>01-07<br>90-96<br>92-97<br>97-03<br>05-07 |
| CK3357   | GSX 600 FW/FX/FY/FK1/FK2/FK3<br>/FK4/FK5/FK6<br>GSF 650 K5/SK5/K6/SAK6<br>GR 650 D/XD<br>GSX 750 FW/W/FX/X/FY/Y/FK1-FK6<br>GSX 750 W/X/Y/K1  | 98-06<br>05-06<br>83<br>98-06<br>98-03                      | CK3378   | FR 80 M/B/N/X/Z/D  | 76-83  |
| CK3358   | SW-1 (NJ45A)<br>GN 250 F/J/M/R/T<br>TU 250 XV/XW<br>TU 250 S/T/XS/XT/X-ST/X-SV/XT-W<br>(NJ47A 100001-115972) Volty<br>TU 250 XTX/X/XTY<br>(NJ47A-115-) Volty<br>TU 250 GY/GBK1 Grass Tracker<br>Big Boy (NJ47A-117/123)<br>VL 250 Y/K1/K5 Intruder | 92<br>87-97<br>97-00<br>92-97<br>99-00<br>00-01<br>00-01/05 | CK3379   | Use CK3381   |  |
|          |  |   | CK3380   | RB 50 H  | 87   |
|          |  |   | CK3381   | GSX 1100 FJ/FK/FL/FM/FN/FP<br>GSXR 1100 G/H/J  | 88-93<br>86-88   |
|          |  |   | CK3382   | VS 1400 All Models   | 87-03  |

| Part No. | Make/Model   | Year   | Part No. | Make/Model  | Year  |
|----------|--|--|----------|---|---|
| CK3383   | <b>SUZUKI Cont.</b><br>Use CK3356  |  | CK3406   | <b>SUZUKI Cont.</b><br>Use CK3387   |   |
| CK3384   | RG 250 WD  | 83   | CK3407   | Use CK3333  |   |
| CK3385   | GSX 400 R2/R3 (GK71B/F)<br>GSX R 400 H<br>GSX 400 X/XA/XS 'Impulse'  | 87   | CK3408   | RF 600 RP/RR/RS/RT  | 93-96   |
| CK3386   | DR 650 SET<br>XF 650 V/W/X/Y 'Freewind'<br>DR 750 SJ/SK<br>DR 800 SL/SM<br><b>CCM</b><br>644 DS/Supermoto<br>R30 (Suzuki 644cc engine)   | 96<br>97-02<br>88-89<br>90-91<br>04<br>02-04                   | CK3409   | Use CK3418  |   |
| CK3387   | GSX 600 FN/FP/FR/FS/FT/FV<br>GSX 750 FK/FL/FM/FN/FP/FR/FS/FT/FV<br>GSX R 750 J/K<br>GSX R 750 L/M/WN/WP/WR/WS  | 92-97<br>89-97<br>88-89<br>90-95                               | CK3410   | Use CK3318  |   |
| CK3388   | GV 1400 'Cavalcade' (All models)   | 85-88  | CK3411   | Use CK3399  |   |
| CK3389   | N/A  |  | CK3412   | Use CK3402  |   |
| CK3390   | LT-F 4WDH/J/K/L/M/N/P/R/S/T/V/W<br>LT-F 250 J/K/L/M/N/P/R/S/T/V/W/Y/K1<br>LT-F 250 FX/FY/FK1/FK2<br>LT-F 250 K3/K5/K6/K7 Ozark<br>LT 250 EEF/EFG<br>LT-F4 WDXM/N/P/R/S/T/V/W<br>LT-F 300 J/K                         | 87-98<br>89-01<br>99-02<br>03/05-07<br>85-86<br>91-98<br>88-89 | CK3413   | Use CK3390  |   |
| CK3391   | Use CK3387   |  | CK3414   | Use CK3386  |   |
| CK3392   | GSX 1100 GM/GN<br>GSX R 1100 K/L/M/N   | 91-94<br>89-92   | CK3417   | GSXR 750 T/V/W/X/K2/K3/K4/K5<br>RF 900 RS/R2S/RT/RV/RW<br>TL 1000 SV/SW<br>GS 1200 SSK1/ZK1 (GV78A)<br>GSF 1200 T/ST/V/SV/W/SW/X/SX<br>/Y/SY/K1/SK1/SK2/K2/K3/SK3<br>/K4/SK4/K5/SK5/SAK6/AK6/<br>/GTSAK6 Bandit<br>GSF 1200 SAV ABS Bandit<br>GSX 1200 FSW/FSX Inazuma  | 97-99/02-05<br>95-98<br>97-98<br>96-06<br>97<br>98-99                         |
| CK3393   | FR 50  | 81-  | CK3418   | RF 900 RR<br>GSXR 1100 WP/WR/WS/WT  | 94<br>93-96   |
| CK3394   | Use CK3374   |  | CK3420   | Use CK1177  |   |
| CK3395   | Use CK3319   |  | CK3421   | No fitment  |   |
| CK3396   | Use CK3386   |  | CK3422   | Use CK1206  |   |
| CK3397   | GSF 400 M/N/P<br>GSF 400 S/V/S-V/VZ-V<br>Bandit (GK7AA)<br>GSX 400 FJ/FK/FAK/FL (GK74A)<br>GSXR 400 J/RR/RAK (GK73A)<br>GSF 400 K/NK/Z/VN/VZM/P/NP<br>/VP/VZP/VR (GK75A) 'Bandit'<br>GSXR 400 RL/RM/RN/RP/RS (GK76A) | 91-95<br>95-97<br>88-90<br>88-90<br>89-94<br>90-95             | CK3424   | Use CK3397  |   |
| CK3398   | Use CK3318   |  | CK3425   | Use CK3397  |   |
| CK3399   | DR 250 SL/SM/SN/SEP/SER/SES<br>DR 350 SL/SM/SN/SP/SER/SES/<br>SET/SEV/SEW/SEX<br>SG 350 N 'Goose'<br><b>QUADZILLA</b><br>WK 300  | 90-95<br>90-99<br>92<br>06                                     | CK3426   | Use CK3399  |   |
| CK3400   | RM 250 N/P<br>RMX 250 N/P  | 92-93<br>92-93   | CK3428   | TL 100 RW/RX/RV/SW/SX/SY  | 98-00   |
| CK3401   | RM 125 N/P/R/S/T/V/W/X/Y/K1  | 92-01  | CK3429   | Use CK3377  |   |
| CK3402   | DR 650 RSEM/RSEN/RSEP/RER/RES<br>DR 650 RL/RM (SP41A)<br>DR 650 RSL/RSM (SP42A)<br>DR 650 RUN/RN/RUP/RP (SP44A/B)  | 92-95<br>90-91<br>90-91<br>92-93                               | CK3430   | GSX 1300 RX/RV/RK1 'Hayabusa'   | 99-01   |
| CK3403   | No fitment   |  | CK3432   | VL 125 Y/K1-K7 "Intruder"   | 00-07   |
| CK3405   | Use CK3392   |  | CK3433   | DR-Z 400 SEY/EY/Y/SK1/EK1/K1<br>/SK2/EK2/K2/SK3/EK3/K3/SK4<br>/EK4/K4/SK5/K5/K6/EK6/SK6<br>/SK7/EK7/K7<br>DR-Z 400 SMK5/6/7<br>LT-Z 400 K3/K4<br><b>CCM</b><br>R 35/R 35 S<br>CR 40 S Cafe Racer<br>CR 40 Street<br>SR 40 Street Scrambler<br>404 E/DS/Supermoto<br><b>KAWASAKI</b><br>KSF 400 A1/A2 (KFX 400)<br>KLX 400 R (KLX 400 B1/B2) | 00-07<br>05-07<br>03-04<br>06-07<br>07<br>07<br>07<br>03-04<br>03-04<br>03-04 |
|          |  |  | CK3435   | TL 1000 SK1/RK1   | 01-02   |
|          |  |  | CK3437   | RMX 250 SN/SR/SS (SJ13A)  | 95-97   |
|          |  |  | CK3439   | GSX 1400 K2/K3/K4/K5/K6/K7  | 02-07   |
|          |  |  | CK3441   | GSX 400 SSN (GK77A) Katana  | 92  |



| Part No. | Make/Model  | Year                             | Part No. | Make/Model   | Year   |       |
|----------|---|----------------------------------|----------|--|--|-------|
| CK3443   | <b>SUZUKI Cont.</b>   |                                  | CK4418   | <b>KAWASAKI Cont.</b>  |  |       |
|          | DL 1000 K2/K3/K4/K5/K6  | 02-07                            |          | No fitment   |  |       |
|          | SV 1000 K3/SK3/K4/SK4/K5/SK5/SK6                                      | 03-06                            |          | CK4419   | KEF 300 B1/B2/B3 Lakota Sport<br>KLF 300 A1/A2/B1-B17/C1-C17   | 01-03 |
|          | GSX 1300 RK2/RZK3/RK3/RK4/RK5<br>/K6/K7                               | 02-07                            |          |  |  | 87-05 |
|          | <b>KAWASAKI</b>   |                                  | CK4420   | Use CK4411   |  |       |
|          | KLV 1000 (LV 1000 A1H/A2H)  | 04-05                            | CK4421   | Z 400 B1/B2/G1<br>Z 440 A2/C1-C2/H1/H2<br>Z 440 D4-D6 (Ltd)  | 78-80<br>80-83<br>82-84  |       |
| CK3445   | GSX 1400 K1   | 01                               | CK4422   | Use CK4446   |  |       |
| CK3447   | LT-Z 400 K5/K6/K7 QuadSport   | 05-07                            | CK4423   | Use CK4425   |  |       |
|          | <b>KAWASAKI</b><br>KSF 400 A3/A6F                                     | 05-06                            |          |  |  |       |
| CK3448   | LT-F 250 K4 Ozark   | 04                               | CK4424   | Z 400 J1-J3<br>ZR 400 A1/B1 (Z400 F)<br>ZX 400 C2 (Z400 F11)<br>ZL 400 A 'Eliminator'<br>ZL 400 'B' Eliminator' 400 SE<br>FX 400 R (ZX 400 E1-E3)<br>GPZ 400 R (ZX400 D1/D2/D3/D3A)<br>GPZ 400 R (ZX 400 F1)<br>ZR 400 Zephyr (G2/G3/G3A/G4/G5)<br>ZRX 400 (ZR 400 E1-E7)<br>ZZR 400 (ZX 400 K1/K2/K3)<br>ZZR 400 (ZX 400 N1-N7)<br>EN 450 A1-A5 (Ltd 450)<br>EX 500 A1-A6/D1-D7 (GPZ 500 S)<br>KLE 500 A1-A12<br>EN 500 A1-A4/B1/B2/C1-C9<br>ER-5 (ER 500 A1/A2/A3/A4/C1-C5P)<br>GPZ 500 (S) (EX 500 B1-B5)<br>GPZ 500 S (EX 500 E1-E10)<br>KLE 500 B1P/B6F/B7F<br>Z 500 A1-A3/B1-B2<br>Z 550 C1-C2 (Ltd)<br>GT 550 G1-G9<br>GPZ 550 D1/H1-H2/A1-A4<br>ZR 550 A1-A2 (Z550 F)<br>ZR 550 B2/B3/B4/B5/B6 "Zephyr"<br>KL 600 A1 (KLR 600)<br>KLR 600 B1/B2/B4/B6-B9<br>GPZ 600 R A1-A6<br>GPX 600 R C1-C3/C6-C7<br>ZL 600 B1<br>ZZR 600 D1/D2/D2A/D3<br>ZZR 600 (ZX 600 E1-E13)<br>ZZR 600 (ZX 600 E6F)<br>ER-6F (EX 650 A6F/A7F)<br>ER-6F (ABS Model) (EX 650 BF6/B7F)<br>ER-6N (ER 650 A6F/A7F)<br>ER-6N (ABS) ER 650 A6F/A7F<br>KLE 650 A7F Versys<br>KLE 650 B7F Versys ABS<br>KLR 650 A1-A3<br>KL 650 B1/B2/B3 Tengai<br>KLX 650 C1/C2/C3<br>ZXR 750 H1/H2 | 80-83<br>83-84<br>85<br>86-87<br>88<br>86-88<br>85-87<br>87<br>97-01<br>94-01<br>90-92<br>93-99<br>86-89<br>87-01<br>91-04<br>90-04<br>97-07<br>88-93<br>94-04<br>05-07<br>79-81<br>80-81<br>83-01<br>81-87<br>83-84<br>91-99<br>84<br>85-94<br>85-89<br>86-96<br>95-97<br>90-92<br>93-05<br>06-07<br>06-07<br>06-07<br>06-07<br>06-07<br>07<br>07<br>87-89<br>89-92<br>93-97<br>89-90 |       |
|          | LT-Z 250 K4/K5/K6 QuadSport   | 05-06                            |          |  |  |       |
| CK3450   | RM-Z 450 K5/K6<br>LT-R 450 K6   | 05-06<br>06                      | CK4425   | KX 125 K1-K5/L1-L4/M1-M3/M6F/N7F<br>Z 200 A1<br>(From E/No 005063)<br>Z 200 A2-A6<br>KL 250 A1-A4/C1/C2<br>KSF 250 A8/A9/A15<br>Z 250 C1/C2/G1/G2<br>KLT 250 C1-C3<br>KH 500 A8<br><b>SUZUKI</b><br>250 S BK2 (LX 250L)  | 94-07<br>78<br>79-83<br>78-84<br>94-95/01-02<br>80-83<br>83-85<br>76<br>02   |       |
| CK3452   | LT-F 500 FK3-FK7  | 03-07                            | CK4426   | Use CK4440   |  |       |
| CK3453   | RM 250 K6/K7  | 06-07                            | CK4427   | Use CK4440   |  |       |
| CK3454   | RM 250 K3/K4/K5   | 03-05                            | CK4428   | Use CK4434   |  |       |
| CK3455   | GSXR 600 K6/K7  | 06-07                            |          |  |  |       |
| CK3456   | GSXR 750 K6/K7  | 06-07                            |          |  |  |       |
| CK3457   | VZR 1800 K6/K7  | 06-07                            |          |  |  |       |
| CK4401   | <b>KAWASAKI</b><br>No fitment   |                                  |          |  |  |       |
| CK4402   | No fitment  |                                  |          |  |  |       |
| CK4403   | Use CK4440  |                                  |          |  |  |       |
| CK4404   | No fitment  |                                  |          |  |  |       |
| CK4405   | No fitment  |                                  |          |  |  |       |
| CK4406   | Use CK4425  |                                  |          |  |  |       |
| CK4407   | No fitment  |                                  |          |  |  |       |
| CK4408   | No fitment  |                                  |          |  |  |       |
| CK4409   | Z1/Z1A/Z1B<br>Z 900 A4/A5<br>Z 1000 A1-A4/H1-H2<br>Z 1000 D1-D3 'ZIR' | 74-76<br>76-77<br>77-81<br>78-80 |          |  |  |       |
| CK4410   | Use CK4425  |                                  |          |  |  |       |
| CK4411   | KE 125 A7-A12   | 80-85                            |          |  |  |       |
|          | KH 125 A1-A4  | 77-81                            |          |  |  |       |
|          | KE 175 D1-D5  | 79-83                            |          |  |  |       |
| CK4412   | No fitment  |                                  |          |  |  |       |
| CK4413   | Z 650 B1-B3/C1/C3/D2-D3/F1-F4   | 77-83                            |          |  |  |       |
|          | Z 700 A1 'Ltd'  | 84                               |          |  |  |       |
|          | ZN 700 A1/A2 'Ltd'  | 84-85                            |          |  |  |       |
|          | ZN 750 N1/N2 'Spectre'  | 82-83                            |          |  |  |       |
|          | Z 750 E1/H1-H2/L1-L4  | 80-84                            |          |  |  |       |
|          | GT 750 P1-P5  | 82-90                            |          |  |  |       |
|          | GPZ 750 R1  | 82                               |          |  |  |       |
|          | GPZ 750 A1-A5   | 83-87                            |          |  |  |       |
| CK4414   | No fitment  |                                  |          |  |  |       |
| CK4415   | No fitment  |                                  |          |  |  |       |
| CK4416   | No fitment  |                                  |          |  |  |       |
| CK4417   | Use CK4421  |                                  |          |  |  |       |

| Part No.                            | Make/Model  | Year  | Part No.           | Make/Model  | Year   |   |                         |   |  |   |            |            |   |
|-------------------------------------|---|---|--------------------|---|--|---|-------------------------|---|--|---|------------|------------|---|
| CK4429                              | <b>KAWASAKI Cont.</b><br>Use CK4435   |   | CK4439             | <b>KAWASAKI Cont.</b><br>KDX 250 B1<br>KLF 400 B1/B3/B3A/B4/B5/B6/B7<br>KX 420 A1/A2  | 81<br>93-98<br>80-81   |   |                         |   |  |   |            |            |   |
| CK4430                              | No fitment  |   |                    | <b>SUZUKI</b><br>LT-F 400 K2/K3 Eiger   | 02-03  |   |                         |   |  |   |            |            |   |
| CK4431                              | Use CK4457  |   |                    | LT-F 400 FK2-FK7 Eiger 4WD  | 02-07  |   |                         |   |  |   |            |            |   |
| CK4432                              | Use CK4436  |   |                    | LT-F 500 FW/FX/FY/FK1/FK2   | 98-02  |   |                         |   |  |   |            |            |   |
| CK4433                              | KDX 250 B2/B3<br>KXT 250 A1 'Tecate'<br>Z 250 A1-A3/B1-B2<br>ER 250 B1-B3 'Scorpion'<br>GPZ 305 A1/B2-B10<br>KX 500 A1/A2 | 82-83<br>84<br>79-81<br>83-88<br>83-96<br>83-84 | CK4440             | AE 80 A1/B1<br>AR 80 A1/C1-C8<br>KSR II (KMX 80 B1/B2)<br>KC 100 C1-C4<br>KE 100 A8-A10<br>KE 100 B1-B15<br>KH 100 A2-A4/G2-G8<br>KM 100 A4-A6<br>KH 125 K1 | 81-83<br>81-91<br>90-91<br>81-83<br>79-81<br>82-98<br>78-87<br>79-80<br>82 |   |                         |   |  |   |            |            |   |
| CK4434                              | ZL 900 A1/A2 'Eliminator'   | 85-86   |                    | CK4441  | Use CK4457   |   |                         |   |  |   |            |            |   |
|                                     | GPZ 1000 RX A1-A3   | 86-88   |                    |   | CK4442   | AE 50 A1-A2<br>AR 50 A1/C2-C10<br>KSR I (KMX 50 B1/B2)  | 81-84<br>81-97<br>90-91 |   |  |   |            |            |   |
|                                     | 1000 GTR (AG 1000 A1-A18)   | 89-03   |                    |   |  | CK4443  | ZX 750 E1/E2 'Turbo'    | 84-87   |  |   |            |            |   |
|                                     | Z 1000 E1/E2 (ST Shaft)   | 79-80   | CK4444             |   |  |   | Use CK4435              |   |  |   |            |            |   |
|                                     | Z 1000 K1 (Ltd) J1-J3   | 81-83   |                    |   |  |   | CK4445                  | Use CK4438  |  |   |            |            |   |
|                                     | Z 1000 R2   | 83  |                    |   |  |   |                         | CK4446  | Z 200 A1 (Up to Eng No.005062<br>KLR 250 D2-D22<br>ZXR 400 L1-L5/L8/L9<br>ZXR 400 H1/H2<br>ZXR 400 R (ZX 400 M1-M4)<br>ZX 400 J1/J2<br>Xanthus (ZR 400 D1/D3/D4) | 77<br>84-05<br>91-03<br>89<br>91-94<br>89-90<br>92-95 |            |            |   |
|                                     | ZL 1000 A1  | 87  |                    |   |  |   |                         |   | CK4447   | Use CK4425  |            |            |   |
|                                     | GPZ 1100 B1-B2  | 81-82   |                    |   |  |   |                         |   |  | CK4448  | Use CK4459 |            |   |
|                                     | GPZ 1100 A1-A3  | 82-85   |                    |   |  |   |                         |   |  |   | CK4449     | Use CK4433 |   |
|                                     | Z 1100 A1-A3  | 81-83   |                    |   |  |   |                         |   |  |   |            | CK4450     | Use CK4459  |
| Z 1100 D1/D2 'Spectre'              | 82-83   | CK4451  |                    | Use CK4434  |  |   |                         |   |  |   |            |            |   |
| Z 1100 R1                           | 84  |   |                    | CK4452  | Z 1300 A1-A3   |   |                         |   |  |   |            |            | 79-81   |
| ZR 1100 A1/A2/A3/A4/B1              | 92-97   |   |                    |   | CK4453   | KX 80 W1/W2/W3<br>KX 85/85 II A1-A5/A6F/A7F<br>/B1-B5/B6F/B7F<br>KX 100 C1/C2/C3<br>AR 125 A1A-A7/B1-B8<br>KMX 125 A1/A2/B1/B2<br>(From E/No MX 125 AE 000001-013436) |                         |   |  |   |            |            | 98-00<br>01-07<br>98-00<br>83-94<br>86-87   |
| ZR 1100 B5 (Zephyr 1100 RS)         | 02  |   | CK4454             |   |  | <b>SUZUKI</b><br>RM 100 K3  |                         |   |  |   |            |            | 03  |
| ZX 10 B1/B2/B3                      | 88-90   |   |                    |   |  | CK4455  | use CK4465              |   |  |   |            |            |   |
| ZRX 1100 (ZX 1100 C1/C2/C3/C4)      | 97-00   |   |                    |   |  |   | CK4455                  | ZG 1300 A1-A3<br>VN 1500 B2/C1/C2/D1<br>VN 1500 C1/C2/D1/D2<br>VN 1500 E1/E2 'Classic'<br>VN 1500 B2-B6<br>VN 1500 G1/G2<br>VN 1500 J1/J2/R1/R2/R3<br>VN 1500 N1/N2/N3 "Classic Fi"<br>VN 1500 P1/P2<br>VN 1500 L1/L2/L3/L4 "Nomad Fi"<br>VN 1600 A1/A2/A3/A6F<br>VN 1600 B1 Mean Streak<br>VN 1600 B2H/B6F/B7F (Mean Streak)<br>VN 1600 D1H/D6F Classic Tourer |  |   |            |            | 84-86<br>88-96<br>94-98<br>98-99<br>88-92<br>98-99<br>99-04<br>00-04<br>02-04<br>00-03<br>03-07<br>04<br>05-07<br>05-07 |
| ZRX 1200 A1/A2/A3/A4/A5/A6F         | 01-07   |   |                    |   |  |   |                         | CK4455  |  |   |            |            |   |
| ZRX 1200 B1-B3                      | 01-03   |   |                    |   |  |   |                         |   | CK4455   |   |            |            |   |
| CK4435                              | KX 250 J1/J2/K1-K4/K5/L1-L4/M1<br>/M2/R1/R6F/R7F  |   |                    |   |  |   |                         |   |  | 92-07   | CK4455     |            |   |
|                                     | EJ 650 A1/C3-C7 (W650)  |   |                    |   |  |   |                         |   |  | 99-05   |            | CK4455     |   |
|                                     | KLR 650 C1-C10  | 95-04   |                    |   |  |   |                         |   |  | CK4455  |            |            |   |
|                                     | VN 700 A1 'Vulcan'  | 85  |                    | CK4455  |  |   |                         |   |  |   |            |            |   |
|                                     | Z 750 Y1 (Ltd)  | 82  |                    |   | CK4455   |   |                         |   |  |   |            |            |   |
|                                     | GPZ 750 R G2/G3   | 85-86   | CK4455             |   |  |   |                         |   |  |   |            |            |   |
|                                     | GPZ 900 R A1-A8   | 84-96   |                    |   |  | CK4455  |                         |   |  |   |            |            |   |
|                                     | ZX-7 RR (ZX 750 N1/N2)  | 96-99   |                    |   |  |   | CK4455                  |   |  |   |            |            |   |
|                                     | GPX 750 F1/F2/F3/F2A  | 87-89   |                    |   |  |   |                         | CK4455  |  |   |            |            |   |
|                                     | VN 750 A2/A3/A4/A5/A10  | 86-94   |                    |   |  |   |                         |   | CK4455   |   |            |            |   |
| ZXR 750 J1/J2/L1/L2/L3/P1-P7        | 91-03   | CK4455  |                    |   |  |   |                         |   |  |   |            |            |   |
| ZXR 750 R (ZX 750 K1/K2/M1/M2)      | 91-94   |   |                    |   |  |   |                         |   |  |   | CK4455     |            |   |
| Z 750 B1/B2                         | 77-78   |   |                    |   |  |   |                         |   |  | CK4455  |            |            |   |
| Z 750 D1                            | 76  |   |                    | CK4455  |  |   |                         |   |  |   |            |            |   |
| VN 800 A1-A3/B1-B10/B6F/C1/C2/E1-E3 | 95-06   |   |                    |   | CK4455   |   |                         |   |  |   |            |            |   |
| VN 900 AF6 Classic                  | 06  |   | CK4455             |   |  |   |                         |   |  |   |            |            |   |
| VN 900 C7F Custom (Cast wheel)      | 07  |   |                    |   |  | CK4455  |                         |   |  |   |            |            |   |
| VN 900 B7F Classis (Spoke wheel)    | 07  |   |                    |   |  |   | CK4455                  |   |  |   |            |            |   |
| ZX-9R (ZX 900 B1-B4)                | 94-97   |   |                    |   |  |   |                         | CK4455  |  |   |            |            |   |
| <b>SUZUKI</b> RM 250 T              | 96  |   |                    |   |  |   |                         |   | CK4455   |   |            |            |   |
| RM 250 V/W/X/Y/K1/K2                | 97-02   | CK4455  |                    |   |  |   |                         |   |  |   |            |            |   |
| CK4436                              | KX 125 B1   |   |                    |   |  |   |                         |   |  |   | 82         | CK4455     |   |
|                                     | KDX 175 A1-A3   |   |                    |   |  |   |                         |   |  | 80-82   | CK4455     |            |   |
|                                     | KH 250 B4-B5  |   |                    | 79-80   |  |   |                         |   |  | CK4455  |            |            |   |
| CK4437                              | Use CK4436  |   |                    |   | CK4455   |   |                         |   |  |   |            |            |   |
|                                     | CK4438  |   | KX 60 A1-A2/B1-B19 | 83-03   |  |   |                         |   |  |   |            |            | CK4455  |
| KX 65 A1/A2/A3/A4/A5/A6/A6F/A7F     |   |   | 00-07              | CK4455  |  |   |                         |   |  |   |            |            |   |
| KX 80 E1/E2                         |   |   | 83-84              |   |  | CK4455  |                         |   |  |   |            |            |   |
| KLX 110 R (KLX 110 A1-A4/A6F)       |   |   | 02-06              |   |  |   | CK4455                  |   |  |   |            |            |   |
| KH 125 K2-10                        |   |   | 82-98              |   |  |   |                         | CK4455  |  |   |            |            |   |
| KH 125 L1 (KH 125 EX)               |   | 83  | CK4455             |   |  |   |                         |   |  |   |            |            |   |
| <b>MODENAS</b>                      |   |   |                    |   |  |   |                         |   | CK4455   |   |            |            |   |
| Kriss 110/115                       |   |   |                    |   |  |   |                         |   |  |   | CK4455     |            |   |
| <b>SUZUKI</b>                       |   |   |                    |   |  |   |                         |   |  | CK4455  |            |            |   |
| Smash 110cc                         |   | 03  |                    |   | CK4455   |   |                         |   |  |   |            |            |   |
| DR-Z 110 K3/K4/K5                   | 03-05   | CK4455  |                    |   |  |   |                         |   |  |   |            |            |   |
| RM 60 K3                            | 03  |   |                    | CK4455  |  |   |                         |   |  |   |            |            |   |
| RM 65 K3/K4/K5                      | 03-05   |   |                    |   |  | CK4455  |                         |   |  |   |            |            |   |

| Part No. | Make/Model   | Year  | Part No. | Make/Model  | Year  |
|----------|--|---|----------|---|---|
| CK4455   | <b>SUZUKI</b><br>VZ 1600 K4 Marauder<br>VZ 1600 K5 (M 1600 Intruder)   | 04<br>05  | CK4482   | <b>KAWASAKI Cont.</b><br>KX 125 F1/G1<br>KDX 200 E1/E2/E3/E4/E5/E6  | 88-89<br>89-94  |
| CK4456   | Use CK4438   |   | CK4483   | Use CK4455  |   |
| CK4457   | KDX 200 A1-A3<br>KX 125 B2/C1<br>KH 400 A3-A5  | 83-85<br>83-84<br>76-78                               | CK4484   | KR1 (250 cc) (KR 250 B2/C2/C3)  | 89-92   |
| CK4458   | Z 1300 A4/A5   | 82-83   | CK4485   | KX 125 H1/H2/J1   | 90-92   |
| CK4459   | KX 250 D1/D2<br>KX 500 B1/B2   | 85-86<br>85-86  | CK4486   | KMX 125 B2-B12 (From E/No MX 125AE 013437)<br>KMX 125 A3/A4/A5<br>KMX 200 A2/A3   | 87-03<br>88-89<br>88-92   |
| CK4460   | Use CK4419   |   | CK4487   | Use CK4424  |   |
| CK4461   | Use CK4439   |   | CK4488   | ZZR 1100 C1/C2/C2A/C3/D1-D9<br>ZX 1100 E1/E2/F1<br>ZZR 1200 C1H/C2H   | 90-01<br>95-98<br>02-04   |
| CK4462   | No fitment   |   | CK4489   | KDX 125 A1/A2/B1/B2   | 90-94   |
| CK4463   | KLF 110 B1-B2  | 87-88   | CK4490   | Use CK4446  |   |
| CK4464   | Use CK1119   |   | CK4491   | Use CK4485  |   |
| CK4465   | KX 250 B1/C1/C2  | 82-84   | CK4492   | Use CK4435  |   |
| CK4466   | Use CK4459   |   | CK4493   | GT 750 P7/P9<br>ZR 750 C1/C2/C3/C4/C5/D1 'Zephyr'<br>ZR-7 (ZR 750 F1/F3/F5)<br>ZR-7S (ZR 750 H1/H3)   | 92-96<br>92-98<br>99-04<br>01-04  |
| CK4467   | No fitment   |   | CK4494   | Use CK4435  |   |
| CK4468   | KX 80 E3/G1/G2/J1/J2   | 85-87   | CK4495   | Use CK4439  |   |
| CK4469   | KX 125 D1/E1/E2<br>KDX 200 C1/C2/C3<br>KL 250 H1<br>KL 250 J1 Stockman<br>KLX 250 D1/D2/F1-F4<br>KLX 250 G1<br>KLX 250 J1-J6 D-Tracker<br>KLX 300 A2-A10/A6F/A7F   | 85-87<br>86-88<br>98<br>93-97<br>94<br>98-03<br>97-07 | CK4496   | Use CK4424  |   |
| CK4470   | Use CK4475   |   | CK4497   | Use CK4434  |   |
| CK4471   | Use CK4435   |   | CK4498   | KX 125 J2   | 93  |
| CK4472   | Use CK4435   |   | CK4499   | Use CK4425  |   |
| CK4473   | GPX 250 F2 (ZX250 F2/F3/F6/F8/F9)<br>GPX 250 RII (EX 250 G)<br>EL 250 D1-D5<br>EL 250 B1-B3 'Eliminator'<br>KLE 250 A1/A1A/A2 (Anhele)<br>GPZ 250 R (EX 250 E)<br>ZZR 250 (EX 250 H1-H13)<br>EL 252 (EL 250 F2/F3) | 88-95<br>88<br>90-94<br>87-89<br>86<br>90-03<br>97-03 | CK4500   | Use CK4435  |   |
| CK4474   | Use CK4424   |   | CK4501   | Use CK4488  |   |
| CK4475   | KX 250 E1/F1/G1/H1H2<br>KXF 250 A1/A2<br>KDX 250 D1<br>KX 500 C1/D1/E1-E16   | 87-91<br>87-88<br>91-93<br>87-04                      | CK4502   | Use CK4469  |   |
| CK4476   | Use CK4479   |   | CK4503   | ZX-6R F1/F2/F3/G1/G2/J1/J2<br>ZX6RR (ZX 600 K1)<br>ZX6R (636cc) (ZX636A1P/B1/B2)<br>Z 750 S (ZR 750 K1/K6F)<br>Z 750 J1/J2/J6F<br><b>SUZUKI</b><br>RG 400 EWF/EW-2G/EWH<br>Walter Wolf (Type 1&2)<br>RG 500 G/CH                              | 95-01<br>03<br>02-04<br>05-06<br>04-07<br>85-87<br>85-87                |
| CK4477   | KX 80 L1<br>KX 100 N1  | 88<br>88  | CK4505   | KDX 200 H1/H2/H3/H4/H5<br>KDX 220 R A4-A12/A6F<br>KDX 220 SR  | 95-99<br>97-06  |
| CK4478   | KX 80 L2/L3/R1-R7<br>KX 100 A1/A2/B1-B7  | 89-97<br>89-97  | CK4508   | BJ 250 B1-B7A 'Estrella'<br>BJ 250 C1-C7/D1-D7/F1/F2<br>BJ 250 E1-E4A Estrella-RS Custom<br>ZR 250 A1-A5<br>ZR 250 B6 (Ballius II)<br>ZXR 250 C1-C5/D1<br>ZXR 250 (ZX 250 A1/A2)<br>ZXR 250 R (ZX 250 B1/B2)<br><b>SUZUKI</b><br>GSX 250 FXK2 | 92-99<br>95-03<br>96-99<br>91-95<br>02<br>91-95<br>89-90<br>89-90<br>02 |
| CK4479   | Use CK4482   |   | CK4509   | KDX 250 SR (KDX 250 F1)   | 91  |
| CK4480   | Use CK4425   |   |          |   |   |
| CK4481   | Use CK1180   |   |          |   |   |

| Part No.                      | Make/Model                      | Year                        | Part No.                    | Make/Model                               | Year       |       |
|-------------------------------|---------------------------------|-----------------------------|-----------------------------|--|------------|-------|
| CK4510                        | <b>KAWASAKI Cont.</b>           |                             | CK5596                      | <b>KTM Cont.</b>                         |            |       |
|                               | ZX9R (ZX 900 C1/C2/E1/E2/F1/F2) | 98-04                       |                             | RXC-E 400                                | 95         |       |
|                               | Z 1000 (ZR 1000 A1/A2/A3/A6F)   | 03-06                       | Contd.                      | EXC-E 620                                | 95         |       |
|                               | Z 1000 (ZR 1000 B7F)            | 07                          | CK5597                      | <b>TRIUMPH</b>                           |            |       |
|                               | Z 1000 ABS (ZR 1000 C7F)        | 07                          |                             | Bonneville (790cc)                       | 01-05      |       |
| ZX10R (ZX 1000 C1/C2/D6F/D7F) | 05-07                           | Speedmaster 800 (790cc)     |                             | 03-04                                    |            |       |
|                               | <b>SUZUKI</b>                   |                             | Bonneville T100             | 02-04                                    |            |       |
|                               | GSXR 1000 K1/K2/K3/K4           | 01-04                       |                             |  |            |       |
| CK4511                        | BN 125 A1-A5/A6F/A7F Eliminator | 98-07                       | CK5598                      | <b>APRILIA</b>                           |            |       |
| CK4513                        | ZX12R (ZX 1200 A1)              | 00                          |                             | AF1 125                                  | 87-91      |       |
| CK4514                        | <b>SUZUKI</b>                   |                             |                             | Classic 125                              | 95-01      |       |
|                               | RM 125 K2/K3/K4/K5/K6/K7        | 02-07                       |                             | MX 125                                   | 04-06      |       |
|                               | RM-Z 250 K4/K5/K6/K7            | 04-07                       |                             | Pegaso 125                               | 91-95      |       |
|                               | <b>KAWASAKI</b>                 |                             | Red Rose 125                | 87-94                                    |            |       |
|                               | KX 250 F (KX 250 N1/N2/T6F/T7F) | 04-07                       | RS 125                      | 92-07                                    |            |       |
|                               | ZX-6R (ZX 600 P7F)              | 07                          | RX 125                      | 92-98                                    |            |       |
|                               | ZX-6R (ZX 636 C1/C6F)           | 05-06                       |                             |  |            |       |
|                               | ZX6RR (ZX 600 M1)               | 04                          | CK5599                      | <b>TRIUMPH</b>                           |            |       |
|                               | ZX-6RR (ZX 600 N1/N6F)          | 05-06                       |                             | Speed Triple (from VIN 141872 to 210444) |            |       |
| CK4515                        | ZX12R (ZX 1200 A2-A4/B1-B4/B6F) | 01-06                       |                             | Speed Triple 1050                        | 05-07      |       |
| CK4516                        | VN 2000 A1/A2/A6F/F7F           | 04-07                       |                             | Daytona (from VIN 132513)                | 01-06      |       |
| CK4517                        | KR 250 A1/A2                    | 84-86                       |                             | RS Sprint (from VIN 139277)              | 02-04      |       |
| CK4518                        | GTR 1400 (ZG 1400 A8F)          | 07                          | ST Sprint (from VIN 138277) | 02-04                                    |            |       |
|                               | ZX 1400 A6F/A7F                 | 06-07                       | Sprint ST (From VIN 208167) | 05-07                                    |            |       |
|                               | ZZR 1400 ABS (ZX 1400 B7F)      | 07                          |                             |  |            |       |
| CK5588                        | <b>TRIUMPH</b>                  |                             | CK5602                      | <b>KTM</b>                               |            |       |
|                               | Adventurer                      | 96-01                       |                             | 250 EXC-G Racing                         | 04         |       |
|                               | Trophy 3 cyl 900                | 92-01                       |                             | 250 EXC Racing                           | 04         |       |
|                               | Trophy 4 cyl 1200               | 92-01                       |                             | 400 EXC                                  | 00-01      |       |
|                               | Trident 750/900                 | 92-98                       |                             | 400 MXC                                  | 01         |       |
|                               | Legend TT                       | 98-01                       |                             | SX 400                                   | 00-01      |       |
|                               | Thunderbird/Sport               | 95-04                       |                             | 450 EXC Racing                           | 04         |       |
|                               | Speed Triple                    | 94-99                       |                             | 450 EXC-G Racing                         | 04         |       |
|                               | Sprint                          | 94-98                       |                             | 450 MXC-G Racing                         | 04         |       |
|                               | Daytona 900/Cyl                 | 93-96                       |                             | 450 SX Racing                            | 04         |       |
|                               | Daytona 1200 4 cyl              | 93-98                       |                             | 520 EXC                                  | 00-01      |       |
|                               | Daytona 750 3 cyl               | 92                          |                             | SX 520                                   | 00-01      |       |
|                               | Daytona 1000 4 cyl              | 92                          |                             | 525 EXC Racing                           | 04         |       |
|                               | Tiger                           | 93-98                       |                             | 525 EXC-G Racing                         | 04         |       |
|                               | Daytona Super 3                 | 94-97                       |                             | 525 MXC Desert Racing                    | 04         |       |
|                               |                                 | 525 MXC-G Racing            | 04                          |  |            |       |
|                               |                                 | 525 SX Racing               | 04-05                       |  |            |       |
| CK5589                        | <b>TRIUMPH</b>                  |                             | CK5605                      | <b>BMW</b>                               |            |       |
|                               | T595/955i Daytona               | 97-00                       |                             | F 650/93/97 (K60/0161/0162)              | 93-03      |       |
|                               | T509 'Speed Triple' 885/955cc   | 97-01                       | F 650 ST (K60/0163)         | 96-00                                    |            |       |
|                               | Sprint ST Upto VIN 139235       | 98-01                       |                             |  |            |       |
|                               | Sprint RS Upto VIN 138656       | 98-01                       |                             |  |            |       |
|                               | Tiger 955cc                     | 99-06                       |                             |  |            |       |
| CK5594                        | <b>KTM</b>                      |                             | CK5610                      | <b>TRIUMPH</b>                           |            |       |
|                               | SX 60                           | 98-00                       |                             | America (Cast wheel)                     | 07         |       |
| SX 65                         | 98-07                           | Scrambler (865cc)           |                             | 06-07                                    |            |       |
|                               |                                 | Speedmaster (865cc)         |                             | 03-06                                    |            |       |
|                               |                                 | Bonneville T100 (865cc)     |                             | 01-07                                    |            |       |
|                               |                                 | Bonneville 800              |                             | 01-04                                    |            |       |
|                               |                                 | Bonneville America          |                             | 02-06                                    |            |       |
|                               |                                 | Bonneville/Bonneville Black |                             | 07                                       |            |       |
|                               |                                 | Speedmaster 865cc           |                             | 03-07                                    |            |       |
|                               |                                 | Thruxton 900                |                             | 04-07                                    |            |       |
| CK5595                        | <b>KTM</b>                      |                             |                             | CK5611                                   | <b>KTM</b> |       |
|                               | 250 EGS                         | 94-99                       |                             |  | SX 85      | 03-07 |
|                               | 250 EXC                         | 94-07                       |                             | SX 105                                   | 04-07      |       |
|                               | 250 MXC                         | 98-99                       |                             |  |            |       |
|                               | SX 250                          | 94-07                       |                             |  |            |       |
|                               | 250 SXS                         | 01-03                       |                             |  |            |       |
|                               | 300 E-GS                        | 94-99                       |                             |  |            |       |
|                               | 300 EXC                         | 94-07                       |                             |  |            |       |
|                               | 300 MXC                         | 94-05                       |                             |  |            |       |
|                               | 300 Six Days                    | 96                          |                             |  |            |       |
|                               | SX 300                          | 94                          |                             |  |            |       |
|                               | 360 EGS                         | 96-97                       |                             |  |            |       |
|                               | 360 MXC                         | 96-01                       |                             |  |            |       |
|                               | 360 SXC                         | 96-97                       |                             |  |            |       |
|                               | 360 SX                          | 96-97                       |                             |  |            |       |
|                               | 360 Six Days                    | 96                          |                             |  |            |       |
|                               | 380 EXC                         | 98-02                       |                             |  |            |       |
|                               | SX 380                          | 98-02                       |                             |  |            |       |

| Part No.                           | Make/Model            | Year                | Part No.                    | Make/Model                    | Year                     |          |
|------------------------------------|-----------------------|---------------------|-----------------------------|-------------------------------|--------------------------|----------|
| CK5612                             | <b>KTM</b>            |                     | CK5631                      | <b>KTM Cont.</b>              |                          |          |
|                                    | 250 EXC Racing        | 02-03/05            |                             | 625 SMC                       | 04/06                    |          |
|                                    | 250 EXC-G Racing      | 03                  |                             | 625 SXC                       | 03-04                    |          |
|                                    | 400 EXC Racing        | 02/05/07            |                             | 640 Adventure-R               | 98-02                    |          |
|                                    | 400 EXC-G Racing      | 02/05-06            |                             | 640 Duke-E                    | 98                       |          |
|                                    | 400 SX Racing         | 02                  |                             | 640 Duke II                   | 99-04                    |          |
|                                    | 400 MXC               | 02                  |                             | 640 LC Rallye Dakar           | 97                       |          |
|                                    | 450 EXC Racing        | 03/05-07            |                             | 640 LC4                       | 99-00                    |          |
|                                    | 450 EXC-G Racing      | 03                  |                             | 640 LC4 Adventure             | 03-06                    |          |
|                                    | 450 LXC-G Racing      | 05                  |                             | 640 LC4 Supermoto             | 03-04                    |          |
|                                    | 450 MXC-G Racing      | 03/05               |                             | 640 LC4-E                     | 00-02                    |          |
|                                    | MXC 450               | 06                  |                             | 640 LC4 Six Days              | 99                       |          |
|                                    | 450 SMR               | 04-05               |                             | 660 LC4                       | 97                       |          |
|                                    | 450 SMS               | 04                  |                             | 660 LC4 Rallye                | 99-00                    |          |
|                                    | 450 SX Racing         | 03/05               |                             | 660 SM Factory Replica        | 02-03                    |          |
|                                    | SMR 450               | 06-07               | 660 SMC                     | 03-04                         |                          |          |
|                                    | SX 450                | 06                  | 660 SMS                     | 04                            |                          |          |
|                                    | 520 SX Racing         | 02                  |                             |                               |                          |          |
|                                    | 525 MXC Desert Racing | 03                  | CK5632                      | <b>KTM</b>                    |                          |          |
|                                    | 525 EXC-G Racing      | 03/05               |                             | 400 RXC-E                     | 95                       |          |
|                                    | 525 EXC               | 03                  | 620 RXC-E                   | 95                            |                          |          |
|                                    | 525 EXC Racing        | 05                  | CK5633                      | <b>KTM</b>                    |                          |          |
|                                    | 525 MXC Desert Racing | 05                  |                             | 660 Rallye                    | 01-03                    |          |
|                                    | 525 SMR               | 04-05               | 660 Rallye Factory          | 04                            |                          |          |
|                                    | 525 SX Racing         | 03                  | CK5634                      | <b>KTM</b>                    |                          |          |
|                                    | MXC 525               | 06                  |                             | F950 Adventure S              | 03-04                    |          |
|                                    | SX 525                | 06                  |                             | 950 Adventure                 | 06                       |          |
|                                    | 540 SXS Racing        | 02                  |                             | 950 Superenduro R             | 07                       |          |
|                                    | SMR 560               | 06-07               |                             | 990 Superduke                 | 06                       |          |
|                                    | CK5624                | <b>TRIUMPH</b>      |                             | CK5635                        | <b>BMW</b>               |          |
|                                    |                       | Rocket 111 (2300cc) | 04-06                       |                               | F 650 Dakar/M (K78/0176) | 03-06    |
|                                    |                       | Rocket 111 Classic  | 07                          | F 650 GS/M (K78/0175)         | 03-07                    |          |
|                                    | CK5628                | <b>CCM</b>          |                             | F 650 CS/M Scarver (K14/0177) | 03-06                    |          |
| 604 Trial/SM/RS/R30 (Rotax engine) |                       | 98-03               |                             |                               |                          |          |
| CK5631                             | <b>KTM</b>            |                     | CK5636                      | <b>BMW</b>                    |                          |          |
|                                    | 350 EXC               | 94                  |                             | F 650 Dakar (K78/0173)        | 99-03                    |          |
|                                    | 350 Super Comp        | 94-95               | F 650 GS (K78/0172)         | 99-03                         |                          |          |
|                                    | 380 EGS               | 98-99               | F 650 CS Scarver (K14/0174) | 00-03                         |                          |          |
|                                    | 400 Duke              | 94-95               | CK6601                      | <b>BMW</b>                    |                          |          |
|                                    | 400 EGS-E             | 97                  |                             | R 45                          | 09/80-85                 |          |
|                                    | 400 EGS               | 94/96-97            |                             | R 45/N                        | 09/80-85                 |          |
|                                    | 400 EXC-E             | 96-97               |                             | R 45 T                        | 09/80-85                 |          |
|                                    | 400 EXC               | 94/96               |                             | R 45 T/N                      | 09/80-85                 |          |
|                                    | 400 LC-4              | 98                  |                             | R 65                          | 09/80-85                 |          |
|                                    | 400 LC4-E             | 00-01               |                             | R 65 LS                       | 81-85                    |          |
|                                    | LC4 R 400             | 99                  |                             | R 65 T                        | 80-85                    |          |
|                                    | 400 LSE               | 97                  |                             | R 65 GS                       | 87-92                    |          |
|                                    | 400 LS-E              | 04                  |                             | R 65 RT                       | 85-88                    |          |
|                                    | 400 Super Comp        | 95                  |                             | R 80 GS                       | 80-87                    |          |
|                                    | 400 Super Comp/EXC    | 96-99               |                             | R 80 ST                       | 82-84                    |          |
|                                    | SXC 400               | 97                  |                             | R 80                          | 09/80-84                 |          |
|                                    | 400 SX                | 99                  |                             | R 80 RT                       | 82-84                    |          |
|                                    | 400 SX-C              | 98                  |                             | R 80 TIC                      | 09/80-85                 |          |
|                                    | 400 SXC               | 00                  |                             | R 100/7 T                     | 09/80-84                 |          |
|                                    | 400 TXC               | 98                  |                             | R 100 CS                      | 80-84                    |          |
|                                    | 540 SX-C              | 98-99               |                             | R 100 RS                      | 09/80-84                 |          |
|                                    | 620 Duke              | 94/97               |                             | R 80                          | 84-95                    |          |
|                                    | 620 EGS               | 94-95               |                             | R 80 RT                       | 84-95                    |          |
|                                    | 620 EGS-E             | 97                  |                             | R 80 GS                       | 87-90                    |          |
|                                    | 620 EGS/Adventure     | 96-97               |                             | R 80 PD/CH                    | 90                       |          |
|                                    | 620 Enduro Ltd        | 97                  |                             | R 80 MYS                      | 94-95                    |          |
|                                    | 620 EXC               | 94-95               |                             | R 80 R                        | 91-94                    |          |
|                                    | 620 LC-4              | 98                  |                             | R 80 GS                       | 96                       |          |
|                                    | 620 LC4 Competition   | 99                  |                             | R 100 MYS                     | 93-96                    |          |
|                                    | 620 LC4 Super Moto    | 99                  |                             | R 100 R                       | 91-95                    |          |
|                                    | 620 LSE               | 97                  |                             | R 100 GS                      | 86-90                    |          |
|                                    | 620 RXC-E             | 96-97               |                             | R 100 PD                      | 89-90                    |          |
|                                    | 620 SC                | 00-01               |                             |                               |                          |          |
|                                    | 620 Six Days          | 96                  |                             | CK6602                        | <b>BMW</b>               |          |
|                                    | 620 Super Comp        | 94-99               |                             |                               | R 45                     | -09/80   |
|                                    | 620 Super Moto        | 98                  |                             |                               | R 45                     | 78-09/80 |
|                                    | SX 620                | 94/97-99            | R 45 N                      |                               | -09/80                   |          |
|                                    | SXC 620               | 97                  | R 65                        |                               | 78-09/80                 |          |
|                                    | 620 TXC               | 98                  |                             |                               |                          |          |
|                                    | 625 SC                | 02                  |                             |                               |                          |          |
|                                    |                       |                     |                             |                               |                          |          |
|                                    |                       |                     |                             |                               |                          |          |
|                                    |                       |                     |                             |                               |                          |          |

| Part No.                                     | Make/Model   | Year  | Part No. | Make/Model | Year |
|--|--|---|----------|------------|------|
| CK6603<br>21 21 1 236 332<br>21 21 1 251 803 | <b>BMW</b><br>R 50/5<br>R 60/5<br>R 60/6<br>R 75/5<br>R 75/6<br>R 90/6<br>R 90 S<br>R 60/7<br>R 60 TIC<br>R 75/7<br>R 80<br>R 80 TIC<br>R 100<br>R 100/7T<br>R 100 RS<br>R 100 RT<br>R 100 S | 69-73<br>69-73<br>73-76<br>69-73/80<br>73-76<br>73-79<br>73-76<br>76-09/80<br>78-09/80<br>76-79<br>77-09/80<br>78-09/80<br>76-77<br>77-09/80<br>76-09/80<br>78-09/80<br>76-80 |          |            |      |
| CK6604<br>21 21 1 464 796<br>21 21 1 450 831 | <b>BMW</b><br>K 75<br>K 75/2<br>K 75 C<br>K 75 RT<br>K 75 S  | 84-96<br>84-96<br>85-88<br>89-96<br>85-95   |          |            |      |
| CK6605<br>21 21 1 451 721<br>21 21 1 464 795 | <b>BMW</b><br>K 100<br>K 100/2<br>K 100 LT<br>K 100 RS<br>K 100 RT (Valve models)<br>K1<br>K 100 RS<br>K 1100 LT<br>K 1100 RS  | 82-88<br>87-90<br>86-91<br>83-89<br>83-89<br>88-93<br>89-92<br>89-99<br>92-96   |          |            |      |
| CK6606                                       | <b>KTM</b><br>125 EGS<br>125 EXC<br>125 Six Days<br>SX 125   | 94-97<br>94-97<br>96<br>94-97   |          |            |      |
| CK6680                                       | <b>APRILIA</b><br>RSV 1000 (All models)<br>SL 1000 Falco<br>ETV 1000 Caponord<br>RST Futura 1000   | 99-07<br>00-04<br>01-07<br>01-04  |          |            |      |
|  |  |   |          |            |      |



# SUPERMOTO OVERSIZE DISC CONVERSIONS

320mm oversize Supermoto discs constructed with forged alloy centre hub for weight reduction and tough billet steel 4mm thickness brake rotor for maximum stopping power. These rotor rings have extra weight reducing scraper holes and are riveted together with a nine button sturdy rivet system.

The rotors **COME COMPLETE WITH ANODISED ALLOY RELOCATION BRACKETS** for the various models listed below and are supplied as a kit with the complete rotor unit and anodised bracket. The brake hose will need to be replaced with a longer version.

| Model   | Year  | 320mm SM Disc | Model                              | Year  | 320mm SM Disc |
|---|-------|---------------|------------------------------------|-------|---------------|
| <b>Honda</b>  |       |               | <b>Yamaha</b>                      |       |               |
| CR 125 RS/RT/RV/RW/RX/R1/R2/R3                      | 95-03 | SM6037        | YZ 125 K/L/M/N/P/R/S               | 98-04 | SM6028        |
| CR 125 R4/R5/R6/R7                                  | 04-07 | SM6437        | YZ 125 T/V/W                       | 05-07 | SM6528        |
| CR 250 RS/RT/RV/RW/RX/R1/R2/R3                      | 95-03 | SM6037        | WR 250 FN/FP/FR/FS                 | 01-04 | SM6028        |
| CR 250 R4/R5/R6/R7                                  | 04-07 | SM6437        | WR 250 FT/FV/FW                    | 05-07 | SM6528        |
| CRF 250 R4/R5/R6/R7                                 | 04-07 | SM6437        | YZ 250 K/L/M/N/P/R/S               | 98-04 | SM6028        |
| CRF 250 X4/X5/R6/R7                                 | 04-07 | SM6437        | YZ 250 T/V/W                       | 05-07 | SM6528        |
| CR 500 RS/RT/RV/RW/RX/R1                            | 95-01 | SM6037        | YZ 250 FN/FP/FR/FS                 | 01-04 | SM6028        |
| XR 250 RT/RV/RW/RX/R1/R2/R3/R4                      | 96-04 | SM6001        | YZ 250 FT/FV                       | 05-06 | SM6528        |
| XR 400 RT/RV/RW/RX/R1/R2/R3/R4/R5/R6                | 96-06 | SM6001        | YZ 250 FW                          | 07    | SM6728        |
| CRF 450 R2/R3                                       | 02-03 | SM6037        | YZ 400 FK/FL                       | 98-99 | SM6028        |
| CRF 450 R4/R5/R6/R7                                 | 04-07 | SM6437        | WR 400 FK/FL/FM/FN                 | 98-02 | SM6028        |
| CRF 450 X5/X6/X7                                    | 05-07 | SM6437        | WR 426 FN/FP                       | 01-02 | SM6028        |
| XR 600 RP/RR/RS/RT/RV/RW/RX/R1                      | 93-00 | SM6001        | YZ 426 FM/FN/FP                    | 00-02 | SM6028        |
| XR 650 RY/R1/R2/R3/R4/R5/R6/R7                      | 00-07 | SM6001        | WR 450 FR/FS                       | 03-04 | SM6028        |
| <b>Kawasaki</b>                                     |       |               | WR 450 FT/FV/FW                    | 05-07 | SM6528        |
| KX 125 K1/K2/K3/K4/K5/L1/L2/L3/L4                   | 94-02 | SM6015        | YZ 450 FR/FS                       | 03-04 | SM6028        |
| KX 125 M1/M2/M3                                     | 03-05 | SM6213        | YZ 450 FT/FV/FW                    | 05-07 | SM6528        |
| KX 125 M6F/M7F                                      | 06-07 | SM6264        | XT 600 E                           | 95-03 | SM6116        |
| KX 250 K1/K2/K3/K4/K5/L1/L2/L3/L4                   | 94-02 | SM6015        | XTZ 660 Tenere                     | 91-98 | SM6116        |
| KX 250 M1/M2/R1                                     | 03-05 | SM6213        | <b>Husaberg</b>                    |       |               |
| KX 250 R6F/R7F                                      | 06-07 | SM6264        | All models                         | 93-99 | SM6125        |
| KX 250 F T6F/T7F                                    | 06-07 | SM6264        | All models                         | 00-07 | SM6032        |
| KX 250 N1/N2  | 04-05 | SM6213        | <b>Husqvarna</b>                   |       |               |
| KX 450 F D6F/D7F                                    | 06-07 | SM6264        | All models <sup>1</sup>            | 95-99 | SM6125        |
| KX 500 E6-E15                                       | 94-03 | SM6015        | All models <sup>2</sup>            | 00-07 | SM6184        |
| KLR 650 A1-A3                                       | 87-89 | SM6042        | <sup>1</sup> 6 bolt zero offset    |       |               |
| <b>Suzuki</b>                                       |       |               | <sup>2</sup> 4 bolt zero offset    |       |               |
| RM 125 T/V/W/X/Y/K1/K2/K3/K4/K5/K6/K7               | 96-07 | SM6017        | <b>KTM</b>                         |       |               |
| RM 250 T/V/W/X/Y/K1/K2/K3/K4/K5/K6/K7               | 96-07 | SM6017        | All models with conventional forks | 94-98 | SM6032E       |
| RM-Z 250 K4/K5/K6/K7                                | 04-07 | SM6213        | All models with upside down forks  | 99-07 | SM6032        |
| DR-Z 400 SY/EY/Y/SEK1/EK1/K1/SK2/EK2/K3/EK3/SEK3/K4 |       |               |                                    |       |               |
| /EK4/SEK4/K5/EK5/SEK5/K6/EK6/SK6/SEK6/K7/SK7/SEK7   | 00-07 | SM6017        |                                    |       |               |
| RM-Z 450 K5/K6/K7                                   | 05-07 | SM6254        |                                    |       |               |

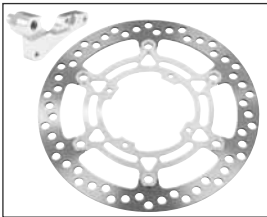

# OVERSIZE MX DISC FRONT FLOATING CONVERSIONS

280mm oversize design with a fully floating construction made from heat treated carbon steel. Comes complete with brackets - front applications only available. This extremely popular range of oversize discs has become a worldwide number one seller. The optimum 280mm design gives a significant improvement to stopping power but also great modulational/control without the risk of 'grounding' on excessively over diameter units. The rotors are quick and easy to fit with beautifully crafted brackets made by Ted Devol in the United States, available for all recent modern moto-x machines. (80/85cc bikes use 250mm oversize not 280mm).

| Model  | Year  | OS Disc  | Model  | Year  | OS Disc  |
|--|-------|----------|--|-------|----------|
| <b>Honda</b>   |       |          | <b>DR 250 RS/RLS/RT/RV/RLV/RLW/</b>            |       |          |
| CR 80 RT/RBT/RV/RBV/RW/RWB/RX/RBX/R1/RBY/R1/RB1/R2/RB2 | 96-02 | OS6058C  | /RW/R1 (SJ45A/DOHC)                            | 95-00 | OS6017   |
| CR 85 R3/RB3/R4/RB4/R5/RB5/R6/RB6/R7/RB7               | 03-07 | OS6058C  | DR 250 RXT/RXL/RTX/RXLV/RXW/RXLW/RXGW/RXGLW    |       |          |
| CR 125 RN/RP/RR  | 92-94 | OS6001E  | /RXY/RXGY (Dejbel 250 XC/GPS (SJ45A))          | 96-98 | OS6017   |
| CR 125 RS/RT/RV/RW/RX/R1/R2/R3                         | 95-03 | OS6037   | DR-Z 250 K1-K7                                 | 01-07 | OS6017   |
| CR 125 R4/R5/R6/R7                                     | 04-07 | OS6437   | RM 250 K/L/M/N/P/R/S                           | 89-95 | OS6017E  |
| CRF 150 F3/F4/F5/F6/F7                                 | 03-07 | OS6001   | RM 250 T/V/W/X/Y/K1/K2/K3/K4/K5/K6/K7          | 96-07 | OS6017   |
| CRF 230 R4/R5/R6/R7                                    | 04-07 | OS6001   | RMX 250 K/M/N/P/R/S                            | 89-95 | OS6017E  |
| CR 250 RN/RP/RR  | 92-94 | OS6001E  | RMX 250 T/V/W                                  | 96-98 | OS6017   |
| CR 250 RS/RT/RV/RW/RX/R1/R2/R3                         | 95-03 | OS6037   | RMX 250 ST/SV/SW/SX (SJ14A)                    | 96-99 | OS6017   |
| CR 250 R4/R5/R6/R7                                     | 04-07 | OS6437   | RMX 250 SN/SR/SS (SJ13A)                       | 95-97 | OS6017   |
| CRF 250 R4/R5/X4/X5/X6/X7                              | 04-07 | OS6437   | RM-Z 250 K4/K5/K6/K7                           | 04-07 | OS6213   |
| CRM 250-1 (MD24)                                       |       | OS6001   | DR-Z 400 SY/EY/Y/SEK1/EK1/K1/SK2/EK2/K2/K3/SK3 |       |          |
| CRM 250-2 RR (MD24)                                    | 94    | OS6001   | /EK3/K4/SK4/EK4/SK5/EK5/K5/K6/EK6/SK6/SK7      | 00-07 | OS6017   |
| CRM 250-3 (MD24)                                       |       | OS6001   | RM-Z 450 K5/K6/K7                              | 05-07 | OS6254   |
| CRM 250 ARV/ARW "Active Radical" (MD32)                | 97-98 | OS6001   | <b>Yamaha</b>                                  |       |          |
| XR 250 RM/RN/RP/RR/RS                                  | 91-95 | OS6001E  | YZ 80/85                                       | 93-07 | OSY6030C |
| XR 250 RT/RV/RW/RX/R1/R2/R3/R4                         | 96-04 | OS6001   | YZ 125 D/E/F/G/H/J                             | 92-97 | OS6028E  |
| CRF 450 R2/R3  | 02-03 | OS6037   | YZ 125 K/L/M/N/P/R/S/T/V/W                     | 98-07 | OS6028   |
| CRF 450 R4/R5/X5/X6/R6/R7/X7 FS Sport                  | 04-07 | OS6437   | YZ 125 T/V/W                                   |       | SM6528   |
| CR 500 RN/RP/RR  | 92-94 | OS6001E  | YZ 250 D/E/F/G/H/J/K/L/M/N/P/R/S/T/V/W         | 92-07 | OS6028   |
| CR 500 RS/RT/RV/RW/RX/R1                               | 95-01 | OS6037   | YZ 250 FM                                      | 07    | OS6728   |
| XR 600 RM  | 91    | OS6001E  | YZ 250 FN/FP/FR/FS/FT/FV                       | 01-06 | OS6028   |
| XR 600 RP/RR/RS/RT/RV/RW/RX/R1                         | 93-00 | OS6001   | YZ 250 T/V/W                                   |       | SM6528   |
| XR 650 RY/R1/R2/R3/R4/R5/R6/R7                         | 00-07 | OS6001   | WR 250 ZD/ZE/ZF/ZG/ZH/ZJ                       | 91-97 | OS6028E  |
| <b>Kawasaki</b>  |       |          | WR 250 K (5EN1)                                | 98    | OS6028   |
| KX 85 A1-A5/B1-B5                                      | 01-06 | OS6186C  | WR 250 FN/FP/FR/FS/FT/FV/FW                    | 01-07 | OS6028   |
| KX 125 K1/K2/K3/K4/K5/L1/L2/L3/L4                      | 94-02 | OS6015   | YZ 400 FK/FL                                   | 98-99 | OS6028   |
| KX 125 M1/M2/M3  | 03-05 | OS6213   | WR 400 FK/FL/FM/FN                             | 98-01 | OS6028   |
| KX 125 M6F/M7F   | 06-07 | OS6264   | WR 426 FN/FP                                   | 01-02 | OS6028   |
| KLX 250 R D1/D2  | 93-94 | OS6015   | YZ 426 FM/FN/FP                                | 00-02 | OS6028   |
| KLX 250 J1-J6 "D-Tracker"                              | 98-03 | OS6240   | WR 450 FR/FS/FT/FV                             | 03-07 | OS6028   |
| KX 250 K1/K2/K3/K4/K5/L1/L2/L3/L4                      | 94-02 | OS6015   | YZ 450 FR/FS/FT/FV                             | 03-07 | OS6028   |
| KX 250 M1/M2/R1  | 03-05 | OS6213   | <b>Honda Dall-Ara</b>                          |       |          |
| KX 250 F (KX 250 N1/N2)                                | 04-05 | OS6213   | XR 250 R                                       | 04    | OS6001   |
| KX 250 F T6F/T7F                                       | 06-07 | OS6264   | XR 400/440 R                                   | 04    | OS6437   |
| KX 250 R6F/R7F   | 06-07 | OS6264   | XR 650 R                                       | 04    | OS6001   |
| KLX 400 R (KLX 400 B1/B2)                              | 03-04 | OS6017   | <b>Honda-HM (Italy)</b>                        |       |          |
| KX 450 F D6F/D7F                                       | 06-07 | OS6264   | CRE 125  | 95-01 | OS6037   |
| KX 500 E6-E16  | 94-04 | OS6015   | CRE 230 Easy Trail                             | 04-07 | OS6437   |
| <b>Suzuki</b>  |       |          | CRE 230 Easy Enduro                            | 04-07 | OS6437   |
| RM 85 K5/L/K5/K6/L/K6/K7/L/K7                          | 05-07 | OSS6030C | CRE 230 Easy Motard                            | 04-07 | OS6437   |
| RM 125 K/L/M/N/P/R/S                                   | 89-95 | OS6017E  | CRE 250  | 97-01 | OS6037   |
| RM 125 T/V/W/X/Y/K1/K2/K3/K4/K5/K6/K7                  | 96-07 | OS6017   | CRE 250  | 02    | OS6037   |
| RM 250 SBK2 (LX 250 L)                                 | 02    | OS6240   | CRE 250 R Enduro                               | 02-03 | OS6037   |

# OVERSIZE MX DISC FRONT FLOATING CONVERSIONS Contd.

| Model                                       | Year  | OS Disc | Model                                      | Year  | OS Disc |
|---|-------|---------|--|-------|---------|
| CR 250 R Moto                               | 04-07 | OS6437  | SX 125 (Upside down forks)                 | 00-07 | OS6032  |
| CRE 250 F Enduro                            | 04-07 | OS6437  | EXC/EGS 200 (Standard forks)               | 98-99 | OS6032E |
| CRE 250 R Enduro                            | 04-07 | OS6437  | EXC/EGS 200 (Upside down forks)            | 00-03 | OS6032  |
| CRE 260                                     | 95-98 | OS6001  | EXC 200 (Upside down forks)                | 04-06 | OS6032  |
| CRE 450 F                                   | 02    | OS6037  | D-XC/E-XC/T-XC/E-GS 250 (Grimeca calipers) | 92-93 | OS6032E |
| CRE 450 F Enduro                            | 04-07 | OS6437  | EXC 250 (Standard forks)                   | 95-99 | OS6032E |
| CRF 450 Motard                              | 04-07 | OS6437  | EXC 250 (Upside down forks)                | 00-07 | OS6032  |
| <b>Husaberg</b>                             |       |         | EXC/EGS 250 (Standard forks)               | 94    | OS6032E |
| All models (fixing pin at end of brake pad) | 93-94 | OS6125  | MX 250 Brembo Calipers                     | 92-93 | OS6032E |
| All models (fixing pin at end of brake pad) | 95-99 | OS6125  | SX 250 (Standard Forks)                    | 94-99 | OS6032E |
| All MX/Enduro models                        |       |         | SX 250 (Upside down forks)                 | 00-07 | OS6032  |
| (Brembo 2 piston caliper 260mmØ front disc) | 00-07 | OS6032  | SXF 250                                    | 04-07 | OS6032  |
| <b>Husqvarna</b>                            |       |         | EXC 350 LC4 (Standard forks)               | 94-95 | OS6032E |
| CR 125                                      | 92-99 | OS6125  | EXC 350 (Standard forks)                   | 96-97 | OS6032E |
| CR 125                                      | 00-04 | OS6125  | SX 360 (Standard forks)                    | 96-97 | OS6032E |
| CR 125                                      | 05-07 | OS6184  | EXC 380 (Standard forks)                   | 98-99 | OS6032E |
| SM 125 S Supermotard                        | 00-07 | OS6184  | EXC 380 (Upside down forks)                | 00-03 | OS6032  |
| WRE 125                                     | 96-97 | OS6125  | SX 380 (Standard forks)                    | 98-99 | OS6032E |
| WR 125                                      | 95-99 | OS6125  | SX 380 (Upside down forks)                 | 00-03 | OS6032  |
| WR/WRE 125                                  | 00-07 | OS6184  | EXC/EGS 400 (USD)                          | 00-02 | OS6032  |
| CR 250                                      | 92-99 | OS6125  | EXC 400 Racing (USD)                       | 00    | OS6032  |
| CR 250                                      | 00-07 | OS6184  | SC 400 (Supercompetition LC4)              | 96-99 | OS6032E |
| TE 250                                      | 02-07 | OS6184  | SX 400 (Upside down forks)                 | 00-02 | OS6032  |
| TC 250                                      | 02-07 | OS6184  | EXC 440                                    | 94-95 | OS6032E |
| WR 250                                      | 92-05 | OS6125  | SX 440                                     | 94-95 | OS6032E |
| WR 360                                      | 97-99 | OS6125  | EXC 450                                    | 03-07 | OS6032  |
| WR 360                                      | 00-03 | OS6184  | SX 450 (USD)                               | 03-07 | OS6032  |
| TE 400                                      | 01-02 | OS6184  | EXC 520                                    | 01-03 | OS6032  |
| TE 410                                      | 96-99 | OS6125  | SX 520                                     | 01-03 | OS6032  |
| TE 410 E                                    | 00    | OS6184  | EXC 525                                    | 03-07 | OS6032  |
| TC 450                                      | 02-06 | OS6184  | MXC 525 (Desert Racing)                    | 03-04 | OS6032  |
| TE 450                                      | 02-06 | OS6184  | SX 525                                     | 03-06 | OS6032  |
| TC/TE 510 (Inc Centennial)                  | 04-07 | OS6184  | MXC 550                                    | 96    | OS6032E |
| TC/TE 570                                   | 01-04 | OS6184  | EGS-E 620 Adventure/Rallye                 | 99    | OS6032E |
| <b>KTM</b>                                  |       |         | SC 620 Supercompetition                    | 96-00 | OS6032E |
| EXC 125 (Standard forks)                    | 95-99 | OS6032E | SX 620/EXC/EGS                             | 94    | OS6032E |
| EXC 125 (Upside down forks)                 | 00-07 | OS6032  | SX EXC/EGS 620                             | 95    | OS6032E |
| EXC/EGS 125 (standard forks)                | 94    | OS6032E | SX 620                                     | 96-99 | OS6032E |
| EXE 125                                     | 00    | OS6032  | LC4 625 SC Supercompetition                | 02    | OS6032  |
| SX 125 (Standard forks)                     | 94-99 | OS6032E | SXC 625                                    | 03-04 | OS6032  |

## EBC RACE DISC PROGRAM - FRONT - SIZES & FITMENTS

| Make & Model (wheel)                                      | Yr    | Dia | Thickness | Offset | Bore  | Bolt Dia | PCD Bolts | No of Bolts | Part No Left | Part No Right | Contour Disc* |
|---|-------|-----|-----------|--------|-------|----------|-----------|-------------|--------------|---------------|---------------|
| Aprilia RSV Mille R/1000 Mille (Inc Radial Mount Caliper) | 01-04 | 320 | 4.5       | 9.5    | 64.2  | 8.5      | 80        | 6           | MD621LD      | MD621RD       | MD621CR       |
| Ducati STD 320 rotor                                      |       | 320 | 5         | 9.65   | 64.2  | 8.5      | 80        | 6           | MD633LD      | MD633RD       | MD633CR       |
| Ducati 320 'Corsa' Hub                                    |       | 320 | 5         | 9.65   | 80.2  | 8.5      | 101.5     | 6           | MD726LD      | MD726RD       |               |
| Ducati 748 SP/Biposto                                     | 95-98 | 320 | 5         | 9.65   | 64    | 8.5      | 80        | 6           | MD2003LD     | MD2003RD      | MD2003CR      |
| Ducati 748 Racing/SPS                                     | 98    | 320 | 5         | 9.65   | 64    | 8.5      | 80        | 6           | MD2003LD     | MD2003RD      | MD2003CR      |
| Ducati 748 SPS  | 99    | 320 | 5         | 9.65   | 64    | 8.5      | 80        | 6           | MD2003LD     | MD2003RD      | MD2003CR      |
| Ducati 748 R/RS/S   | 00    | 320 | 5         | 9.65   | 64    | 8.5      | 80        | 6           | MD633LD      | MD633RD       | MD633CR       |
| Ducati 748 R  | 01-02 | 320 | 4.5       | 14.5   | 64.2  | 8.5      | 80        | 6           | MD636LD      | MD636RD       | MD636CR       |
| Ducati 748 S  | 01-02 | 320 | 5         | 9.65   | 64    | 8.5      | 80        | 6           | MD633LD      | MD633RD       | MD633CR       |
| Ducati 749/749 S/749 R                                    | 03-06 | 320 | 4.5       | 14.5   | 72.2  | 8.5      | 90        | 5           | MD622LD      | MD622RD       | MD636CR       |
| Ducati 851 Superbike Biposto                              | 89-92 | 320 | 5         | 9.65   | 64    | 8.5      | 80        | 6           | MD2003LD     | MD2003RD      | MD2003CR      |
| Ducati 888 SP4/SP5  | 92-93 | 320 | 5         | 9.65   | 64    | 8.5      | 80        | 6           | MD2003LD     | MD2003RD      | MD2003CR      |
| Ducati 888 Superbike Strada                               | 94-95 | 320 | 5         | 9.65   | 64    | 8.5      | 80        | 6           | MD2003LD     | MD2003RD      | MD2003CR      |
| Ducati 916 SP   | 94-96 | 320 | 5         | 9.65   | 64    | 8.5      | 80        | 6           | MD2003LD     | MD2003RD      | MD2003CR      |
| Ducati 916 Biposto-Senna                                  | 94-98 | 320 | 5         | 9.65   | 64    | 8.5      | 80        | 6           | MD2003LD     | MD2003RD      | MD2003CR      |
| Ducati 916 SPS (996cc)                                    | 98    | 320 | 5         | 9.65   | 64    | 8.5      | 80        | 6           | MD2003LD     | MD2003RD      | MD2003CR      |
| Ducati 996  | 98    | 320 | 5         | 9.65   | 64    | 8.5      | 80        | 6           | MD2003LD     | MD2003RD      | MD2003CR      |
| Ducati 996 SPS/SPS II                                     | 99    | 320 | 5         | 9.65   | 64    | 8.5      | 80        | 6           | MD633LD      | MD633RD       | MD633CR       |
| Ducati 996  | 00    | 320 | 5         | 9.65   | 64    | 8.5      | 80        | 6           | MD633LD      | MD633RD       | MD633CR       |
| Ducati 996 S  | 01    | 320 | 5         | 9.65   | 64    | 8.5      | 80        | 6           | MD2003LD     | MD2003RD      | MD2003CR      |
| Ducati 998 S  | 02    | 320 | 4.5       | 14.5   | 64.2  | 8.5      | 80        | 6           | MD636LD      | MD636RD       |               |
| Ducati 998 R  | 02    | 320 | 5         | 9.65   | 64    | 8.5      | 80        | 6           | MD2003LD     | MD2003RD      | MD2003CR      |
| Ducati 998  | 02-03 | 320 | 4.5       | 14.5   | 64.2  | 8.5      | 80        | 6           | MD636LD      | MD636RD       |               |
| Ducati 999/999 S/999 R                                    | 03-06 | 320 | 4.5       | 14.5   | 72.2  | 8.5      | 90        | 5           | MD622LD      | MD622RD       |               |
| Honda RC 30 Oversize                                      |       | 320 | 5         | 17.8   | 58.3  | 6.3      | 74        | 6           | MD702LD      | MD702RD       |               |
| Honda CBR 600 F2 (Oversize Floating Conv.)                | 91-94 | 310 | 4.7       | 0      | 144.3 | 10.5     | 166       | 6           | MD601LD      | MD601RD       |               |
| Honda CBR 600 F3 Oversize (EBC 1003 type)                 | 95-98 | 320 | 5         | 17.2   | 58.3  | 6.3      | 74        | 6           | MD709LD      | MD709RD       |               |
| Honda CBR 600 F3/SJR/SE                                   | 95-98 | 296 | 5         | 17.2   | 58    | 6.3      | 74        | 6           | MD1003LD     | MD1003RD      | MD1003CR      |
| Honda CBR 600 F4 Standard 296mm disc                      | 99-00 | 296 | 5         | 17.2   | 62.2  | 6.3      | 78        | 6           | MD1014LD     | MD1014RD      | MD1014CR      |

\*Low profile disc requires narrow band (26mm) pad. Requires spacers for wheels designed for dished hubs. L/R = Left or Right

\*\*Wide band disc suitable for standard factory GSXR/ZXR/PM 6 pot calipers. Requires spacers for aftermarket wheels designed for dished hubs.

\*2 sets required as not handed.

FOR TECHNICAL INFO SEE START OF CATALOGUE

RACE/SPECIAL DISCS



| Make & Model (wheel)   | Yr    | Dia | Thickness | Offset | Bore  | Bolt Dia | PCD Bolts | No of Bolts | Part No Left | Part No Right | Contour Disc* |
|--|-------|-----|-----------|--------|-------|----------|-----------|-------------|--------------|---------------|---------------|
| Honda CBR 600 F4i Sport  | 01-05 | 296 | 4.7       | 12.5   | 95    | 6.3      | 110       | 6           | MD1141LD     | MD1141RD      | MD1141CR      |
| Honda CBR 600 RR3/4/5/6/7                                      | 03-07 | 310 | 4.5       | 12.5   | 94.2  | 6.3      | 110       | 6           | MD1152LD     | MD1152RD      | MD1152CR      |
| Honda RVF 750 R (RC45)   | 94-95 | 310 | 5.5       | 21.1   | 58    | 6.3      | 74        | 6           | MD1012LD     | MD1012RD      |               |
| Honda 750 R (RC 30)  | 90    | 310 | 6         | 17.8   | 58    | 6.3      | 74        | 6           | MD1010LD     | MD1010RD      |               |
| Honda CBR 900 R Oversize (EBC 1014 type)                       | 92-93 | 320 | 5         | 17.2   | 62.2  | 6.3      | 78        | 6           | MD716LD      | MD716RD       |               |
| Honda CBR 900 RR Fireblade                                     | 95-97 | 296 | 5         | 17.2   | 58    | 6.3      | 74        | 6           | MD1003LD     | MD1003RD      | MD1003CR      |
| Honda CBR 900 RR Fireblade                                     | 98-99 | 310 | 5         | 21.1   | 62    | 6.3      | 78        | 6           | MD1134LD     | MD1134RD      | MD1134CR      |
| Honda CBR 929 RR (929cc model)                                 | 00-01 | 330 | 4.5       | 12.5   | 94.3  | 6.3      | 110       | 6           | MD1137LD     | MD1137RD      | MD1137CR      |
| Honda CBR 954 RR (954cc model)                                 | 02-03 | 330 | 4.5       | 12.5   | 94.3  | 6.3      | 110       | 6           | MD1137LD     | MD1137RD      | MD1137CR      |
| Honda CBR 1000 RR4/RR5   | 04-05 | 310 | 5         | 12.25  | 94.2  | 6.3      | 110       | 6           | MD1153LD     | MD1153RD      | MD1153CR      |
| Honda CBR 1000 RR6/RR7   | 06-07 |     |           |        |       |          |           |             | MD1161LD     | MD1161RD      | MD1161CR      |
| Honda RVT 1000 R (RC51)  | 00-06 | 320 | 4.5       | 12.5   | 94.3  | 6.3      | 110       | 6           | MD1138LD     | MD1138RD      | MD1138CR      |
| Honda VTR 1000 F Super Hawk                                    | 98-06 | 296 | 5         | 17.2   | 58    | 6.3      | 74        | 6           | MD1003LD     | MD1003RD      | MD1003CR      |
| Kawasaki Ex (GPz) 500 Floating Rotor Conversion                | 87-93 | 280 | 5         | Ø      | 130.3 | 10.5     | 150       | 6           | MD714LD      |               |               |
| Kawasaki Ex (GPz) 500 Floating Rotor Conversion                | 94-05 | 280 | 5         | Ø      | 130.3 | 10.5     | 150       | 6           |              | MD714RD       |               |
| Kawasaki ZX 6R (ZX 600 F1/F2/F3)                               | 95-97 | 299 | 4.7       | 12.5   | 61    | 10.5     | 81.2      | 5           | MD4008LD     | MD4008RD      | MD4008CR      |
| Kawasaki 6R (ZX 600 G1/G2/J1/J2/J3)                            | 98-02 | 299 | 4.7       | 13.4   | 61    | 10.5     | 81.2      | 5           | MD4136LD     | MD4136RD      | MD4136CR      |
| Kawasaki 6RR (ZX 600 K1/M1) 599cc                              | 03-04 | 280 | 5.8       | 0      | 80.4  | 10.5     | 100       | 5           | MD4151LD     | MD4151RD      | MD4151CR      |
| Kawasaki ZX 6R (ZX 636 A1)                                     | 02    | 299 | 4.7       | 13.4   | 61    | 10.5     | 81.2      | 5           | MD4136LD     | MD4136RD      | MD4136CR      |
| Kawasaki 6R (ZX 636 B1/B2) 636cc                               | 03-04 | 280 | 5.8       | 0      | 80.4  | 10.5     | 100       | 5           | MD4151LD     | MD4151RD      | MD4151CR      |
| Kawasaki ZX6R (ZX 600 N1/N6F)                                  | 05-06 | 380 | 5.8       | 0      | 80.4  | 10.5     | 100       | 5           |              |               | MD4152CR      |
| Kawasaki ZX6RR (ZX 636 C1/C6F)                                 | 05-06 | 380 | 5.8       | 0      | 80.4  | 10.5     | 100       | 5           |              |               | MD4152CR      |
| Kawasaki ZX 7R (ZX 750 P1-P8) (6 piston pad) Tokico caliper    | 96-03 | 320 | 5         | 13.1   | 61    | 10.5     | 81.2      | 6           | MD4022LD     | MD4022RD      | MD4022CR      |
| Kawasaki ZX 7RR (ZX 750 N1/N2) (6 piston pad) Nissin caliper   | 96-99 | 320 | 5         | 13.1   | 61    | 10.5     | 81.2      | 6           | MD4022LD     | MD4022RD      | MD4022CR      |
| Kawasaki ZX-9R B1/B2/B3/B4 Ninja                               | 94-97 | 320 | 5         | 13.1   | 61    | 10.5     | 81.2      | 6           | MD4022LD     | MD4022RD      | MD4022CR      |
| Kawasaki ZX-9R (ZX 900 C1/C2)                                  | 98-99 | 299 | 4.7       | 13.4   | 61    | 10.5     | 81.2      | 5           | MD4136LD     | MD4136RD      | MD4136CR      |
| Kawasaki ZX9R (ZX 900 E1/E2)                                   | 00-01 | 310 | 5         | 13.25  | 61    | 10.5     | 81.2      | 5           | MD4012LD     | MD4012RD      | MD4012CR      |
| Kawasaki ZX9R (ZX 900 F1/F2)                                   | 02-03 | 320 | 5         | 13.1   | 61    | 10.5     | 81.2      | 6           | MD4022LD     | MD4022RD      | MD4022CR      |
| Kawasaki ZX10R (ZX 1000 C1/C2/D6F/D7F)                         | 04-07 | 300 | 5.8       | 0      | 80.4  | 10.5     | 100       | 5           |              |               | MD4152CR      |
| Suzuki - Oversize 320mm  | -97   | 320 | 5         | 22.3   | 64.2  | 10.5     | 86        | 5           | MD700LD      | MD700RD       |               |
| Suzuki/PM Superbike (zero offset) <sup>1</sup> (Narrow band)   | -98   | 320 | 5         | Ø      | 64.2  | 10.5     | 86        | 5           | MD717LD      | MD717RD       |               |
| Suzuki/PM Superbike (zero offset) <sup>2</sup> (Standard band) | -98   | 320 | 5         | Ø      | 64.2  | 10.5     | 86        | 5           | MD718LD      | MD718RD       |               |
| Suzuki GSX-R 600 WN/WP   | 92-93 | 310 | 5         | 22.3   | 64.2  | 10.5     | 86        | 5           | MD3007LD     | MD3007RD      | MD3007CR      |
| Suzuki GSXR 600 V/W/X/Y/K1-K3/ZK3                              | 97-03 | 320 | 5         | 0      | 69    | 10.5     | 91        | 5           | MD3058LD     | MD3058RD      | MD3058CR      |
| Suzuki GSXR 600 K4/K5  | 04-05 | 300 | 5.5       | 0      | 69.2  | 10.5     | 91        | 5           | MD3089LD     | MD3089RD      | MD3089CR      |
| Suzuki GSXR 600 K6/K7  | 06-07 | 310 | 5.5       | 0      | 100.2 | 10.5     | 120       | 5           | MD3091LD     | MD3091RD      | MD3091CR      |
| Suzuki GSX-R 750 T/V/W/X                                       | 96-99 | 320 | 5         | 0      | 69    | 10.5     | 91        | 5           | MD3058LD     | MD3058RD      | MD3058CR      |
| Suzuki GSX-R 750 Y/K1/K2/K3                                    | 00-03 | 320 | 5         | 0      | 69    | 10.5     | 91        | 5           | MD3058LD     | MD3058RD      | MD3058CR      |
| Suzuki GSXR 750 K4/K5  | 04-05 | 300 | 5.5       | 0      | 69.2  | 10.5     | 91        | 5           | MD3089LD     | MD3089RD      | MD3089CR      |
| Suzuki GSXR 750 K6/K7  | 06-07 | 310 | 5.5       | 0      | 100.2 | 10.5     | 120       | 5           | MD3091LD     | MD3091RD      | MD3091CR      |
| Suzuki GSXR 1000 K1/K2   | 01-02 | 320 | 5         | 0      | 69    | 10.5     | 91        | 5           | MD3058LD     | MD3058RD      | MD3058CR      |
| Suzuki GSXR 1000 K3/K4   | 03-04 | 300 | 5.5       | 0      | 69.2  | 10.5     | 91        | 5           | MD3089LD     | MD3089RD      | MD3089CR      |
| Suzuki GSXR 1000 K5/K6/K7                                      | 05-07 | 310 | 5.5       | 0      | 100.2 | 10.5     | 120       | 5           | MD3091LD     | MD3091RD      | MD3091CR      |
| Triumph Daytona 955i (6 bolt)                                  | 98-00 | 320 | 5         | 10     | 78    | 10.5     | 100.5     | 6           | MD647LD      | MD647RD       |               |
| Triumph Daytona 955i (5 bolt)                                  | 01-05 | 320 | 4.3       | 14.5   | 78    | 10.5     | 100       | 5           | MD669LD      | MD669RD       |               |
| Triumph TT 600   | 00-03 | 310 | 4.5       | 15.8   | 78.2  | 10.5     | 100       | 6           | MD662LD      | MD662RD       |               |
| Triumph Thruxton 900   | 04-05 | 320 | 5         | 0      | 144.3 | 6.5      | 166       | 6           | MD629LD      |               |               |
| Yamaha TZ 125/250  | -97   | 282 | 5         | 10.0   | 64.2  | 8.5      | 80        | 6           | MD2022LD     | MD2022RD      |               |
| Yamaha TZ 125/250  | 98-05 | 299 | 5         | 10     | 64.2  | 8.5      | 80        | 6           | MD730LD      | MD730RD       |               |
| Yamaha YZF 600 RG/RGC/RH/RHC                                   | 95-96 | 298 | 5         | 9.5    | 64    | 8.5      | 80        | 6           | MD2001LD     | MD2001RD      | MD2001CR      |
| Yamaha YZF 600 R/RJ/RK/RL/RM/RN/RR/RRS                         | 97-04 | 298 | 5         | 0      | 132   | 8.5      | 150       | 6           | MD2074LD     | MD2074RD      | MD2074CR      |
| Yamaha YZF 600 RRL/RRM/RRN/RRP (R6)                            | 99-02 | 298 | 5         | 0      | 132   | 8.5      | 150       | 6           | MD2074LD     | MD2074RD      | MD2074CR      |
| Yamaha YZF 600 RRR/RRS (R6)                                    | 03-04 | 299 | 5         | 0      | 132.5 | 8.5      | 150       | 5           | MD2082LD     | MD2082RD      | MD2082CR      |
| Yamaha R6 RRT/RRV/RRW  | 05-07 | 310 | 4.5       | 0      | 132.2 | 8.5      | 150       | 5           | MD2095LD     | MD2095RD      | MD2095CR      |
| Yamaha YZF 1000 R Thunderace                                   | 97    | 298 | 5         | 0      | 132   | 8.5      | 150       | 6           | MD2074LD     | MD2074RD      | MD2074CR      |
| Yamaha YZF 'R1'  | 98-03 | 298 | 5         | 0      | 132   | 8.5      | 150       | 6           | MD2074LD     | MD2074RD      | MD2074CR      |
| Yamaha YZF R1 (5VY)  | 04-06 | 320 | 4.5       | 0      | 132.2 | 8.5      | 150       | 5           | MD2094LD     | MD2094RD      | MD2094CR      |
| Yamaha YZF R1  | 07    | 310 | 5         | 0      | 132.2 | 8.5      | 150       | 5           | MD2102D      | MD2102RD      | MD2102CR      |

<sup>1</sup>Low profile disc requires narrow band (26mm) pad. Requires spacers for wheels designed for dished hubs. L/R = Left or Right

<sup>2</sup>Wide band disc suitable for standard factory GSXR/ZXR/PM 6 pot calipers. Requires spacers for aftermarket wheels designed for dished hubs.

\*2 sets required as not handed.

FOR TECHNICAL INFO SEE START OF CATALOGUE

RACE/SPECIAL DISCS

To special order discs not identifiable in our catalogue please copy this page - fill in all details and fax to our technical department on (01604) 583744.

Name: \_\_\_\_\_

Phone # \_\_\_\_\_

Address: \_\_\_\_\_

Bike Details: \_\_\_\_\_

\_\_\_\_\_

Wheel Details: \_\_\_\_\_

\_\_\_\_\_

|                     |             |  |
|---------------------|-------------|--|
| No of Discs needed: | FRONT LEFT  |  |
|                     | FRONT RIGHT |  |
|                     | REAR        |  |

## • DIMENSIONS OF DISC •

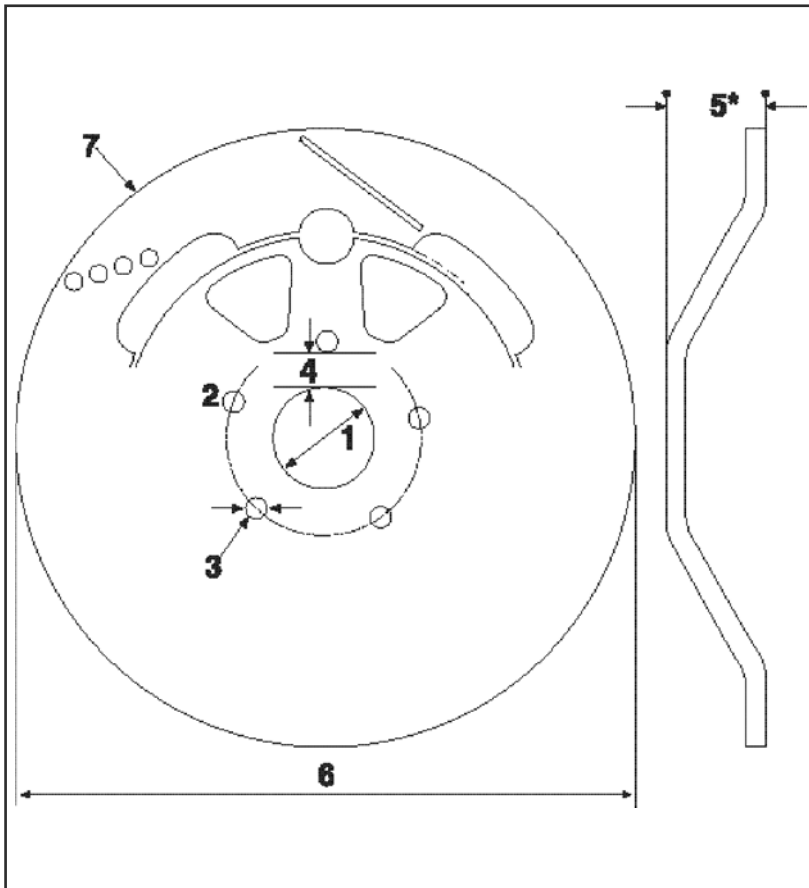

|            |   |  |
|------------|---|--|
| <b>1</b>   | Bore Dia in mm  |  |
| <b>2</b>   | No Holes in Hub   |  |
| <b>3</b>   | Dia of Hub Holes in mm  |  |
| <b>4</b>   | To determine PCD of Holes measure wall section only.<br><small>(From inside bolt hole to inside carrier bore)</small> |  |
| <b>5</b>   | Offset in mm  |  |
| <b>6</b>   | Dia of Disc in mm   |  |
| <b>7</b>   | Thickness of Disc in mm   |  |
| RACE USE   |   |  |
| STREET USE |   |  |

\* Measured from back of hub abutment face to front of disc.

### OUTLINE OF BRAKE PADS TO BE USED WITH DISC













### For EBC use only

|                    |  |
|--------------------|--|
| Disc #             |  |
| Price ea           |  |
| Delivery Time      |  |
| Method of Shipment |  |
| Method of Payment  |  |









RACE/SPECIAL DISCS

# STREETBIKE DISC BUYERS GUIDE

| DISC No.  | FRONT/ REAR | TYPE | MODELS  | DIA (MM) | DISC No.   | FRONT/ REAR  | TYPE | MODELS   | DIA (MM) |
|---|-------------|------|---|----------|--|--------------|------|--|----------|
| Old Part No.<br>MD506LS<br>MD506RS<br>Equivalent New Nos.<br>FSD001<br>FSD003<br>FSD005C<br>FSD007<br>FSD009<br>FSD011C                     | FRONT       | S/F  | Harley Davidson 11 1/2" Front Floating Disc Conversion. (Sportsters & Big Twins with speedo notch) See main catalogue listing for full fitment info.  | 292      | MD602LS<br>MD602RS<br>Contd.<br>            | FRONT /REAR  | F    | <b>BMW</b><br>R 100/7T 77-84<br>R 100 S 76-80<br>R 100 RS 76-84<br>R 100 RT 78-84  | 260      |
| MD508SKL<br>MD508SKR<br>Equivalent New Nos.<br>RSD013C<br>RSD015<br>RSD017C<br>RSD019   | REAR        | S/F  | As above but with counterbored. Hardware bolt kit included. (where originally countersunk hardware fitted). See main catalogue listing for full fitment info.   | 292      | MD603LS<br>MD603RS<br>                      | FRONT        | D    | <b>BMW</b><br>K75/K75-2 (Non ABS) 84-07/90<br>K75/75-S (ABS Model) 08/90-96<br>K75 RT (ABS Model) 89-96<br>K75 S (ABS Model) 85-95<br>K100/2 (ABS 8 Valve Model) 87-90<br>K100 LT (ABS 8 Valve Model) 86-91<br>K100 RS (ABS Model 8 Valve) 83-89<br>K 100 RT (ABS 8 Valve) 83-89 | 285      |
| MD509SR   | REAR        | S    | Harley Davidson - FLT, FLHT, FLHTCI 86-99<br>Harley Davidson - FLHR, FLHRCI 94-99   | 292      | MD604LS<br>MD604RS<br>(31.5mm offset)<br>   | FRONT        | F    | <b>BMW</b><br>K 75/75-S 84-88<br>K 75/75-2 88-96<br>K 75 C 85-88<br>K 75 RT 89-96<br>K 75 S 85-95<br>K 1000 82-88<br>K 100/2 87-90<br>K 100 LT 86-91<br>K 100 RS 83-89<br>K 100 RT 83-89   | 285      |
| MD511   | REAR        | S    | Buell All models 94-02  | 240      | MD605LS<br>MD605RS<br>(23.3mm offset)<br>  | FRONT        | F    | <b>BMW</b><br>R 65 88-89<br>R 65 RT 85-88<br>R 65 LS 81-85<br>R 80/R 80 RT 84-95<br>R 80 Mystic 94-95<br>R 80 R 91-94<br>R 850 GS 96<br>R 80 GS/PD/CH/ST 80-95<br>R 100 GS/PD 89-96<br>R 100 RS 86-92<br>R 100 RT 87-95<br>R 100 Mystic 93-96<br>R 100 R 91-95                   | 285      |
| MD512LS<br>MD512RS<br>FSD002<br>FSD004<br>FSD006C<br>FSD008<br>FSD010<br>FSD012C  | FRONT       | S/F  | Harley Davidson All models, 2000 onwards (Check main catalogue for model fitments)  | 292      | MD606LS<br>MD606RS<br>(47.8mm offset)<br> | FRONT        | F    | <b>BMW</b><br>R 45 All models 78-85<br>R 65 GS 87-92<br>R 65 T 80-85<br>R 65 LS (Brembo caliper) 81-85<br>R 100/7T 80-84   | 260      |
| Old Part No.<br>MD513SKL<br>MD513SKR<br>Equivalent New Nos.<br>RSD014C<br>RSD018C   | REAR        | S/F  | Harley Davidson All models, 2000 onwards (Check main catalogue for model fitments)  | 292      | MD607LS<br>MD607RS<br>                    | FRONT        | F    | <b>BMW</b><br>K100 RS 89-92<br>K1 88-93<br>K 1100 LT 89-99<br>K 1100 RS 92-96<br>R 850 RT 96-01<br>R 1100 R 93-01<br>R 1100 RS 92-01<br>R 1100 RT 94-01  | 305      |
| MD514LS/RS  | FRONT       | S    | Harley Davidson VRSCA V-Rod 02-04   | 292      | MD608LS<br>MD608RS   |              |      | USE MD607LS/RS   |          |
| MD515   | REAR        | S    | Harley Davidson VRSCA V-Rod 02-04   | 292      | MD609LS<br>MD609RS<br>                    | FRONT / REAR | D    | <b>DUCATI</b><br>900 SS-Darmah 78<br>900/1000 Hailwood Replica 79/84<br><b>LAVERDA</b><br>750 SF2 74<br>750 SFC 74<br>750 SF3 76-77<br>1000 3C 74-75<br>1000 3CL 76-81<br>1000 RGS 82<br>1000 RGA/RGS Exec 83<br>1200 78-79<br>1200 TS/Mirage 81                                 | 280      |
| MD516LS/RS  | FRONT       | S    | Harley Davidson V-Rod Models 06-<br>Check main page applications.   | 300      | MD609LS<br>MD609RS<br>                    | REAR         | D    | <b>DUCATI</b><br>900/1000 Hailwood Replica 79/84<br><b>LAVERDA</b><br>750 SFC 74<br>750 SF3 76-77<br>1000 3C 74-75<br>1000 3CL 76-81   | 280      |
| MD517   | REAR        | S    | Harley Davidson V-Rod Models 06-<br>Check main page applications.   | 300      |  |              |      |  |          |
| MD518LS<br>(Spoke wheel models)   | FRONT       | F    | Harley Davidson<br>FXBi Street Bob 06<br>FXDCi Dyna Superglide Custom 06<br>FXDWGi Dyna Wide Glide 06<br>FXDLi Dyna Low Rider 06<br>FXDi 35 "35th Anniversary Super Glide" 06   | 300      |  |              |      |  |          |
| MD601LS<br>MD601RS<br>① Oversize floating conversion<br> | FRONT       | F    | CBR 600 FM/FN/FP/FR 91-94<br><b>TRIUMPH</b><br>① Bonneville 800 01-05<br>① Bonneville T100 02-05<br>① Bonneville America 02-05<br>① Speedmaster (865cc) 05<br>① Thunderbird Sport 98-00<br>① Tiger 900 885cc 97-99<br>① Tiger 955cc Spoke wheel 99-04 | 310      |  |              |      |  |          |
| MD602LS<br>MD602RS<br>(35.8mm offset)<br>                | FRONT /REAR | F    | <b>BMW</b><br>R 60/7 76-80<br>R 60 TIC 78-82<br>R 75/6 / 75/7 73-79<br>R 80 77-84<br>R 80 RT 82-84<br>R 80 TIC 78-85<br>R 90 S 73-76<br>R 90/6 73-76<br>R 100 76-77   | 260      |  |              |      |  |          |









D = Dished Solid Original (We replace with floating rotor conversion unit) F = Floating Rotor S = Solid Rotor SF = Solid Flat Original Disc which we replace with fully floating unit - fits direct no mods required.

# STREETBIKE DISC BUYERS GUIDE

| DISC No.  | FRONT/ REAR          | TYPE         | MODELS   | DIA (MM)                            | DISC No.  | FRONT/ REAR        | TYPE  | MODELS   | DIA (MM)   |
|---|----------------------|--------------|--|-------------------------------------|---|--------------------|-------|--|--|
| MD609LS<br>Contd.<br>              | REAR                 | D            | <b>LAVERDA</b><br>1000 RGS 82<br>1000 RGA/RGS Exec 83<br>1000 SFC 85-86<br>1200 78-79<br>1200 TS/Mirage 81   | 280                                 | MD614LS<br>MD614RS<br>MD614C<br>Contd.<br> | FRONT              | F     | <b>MOTO GUZZI</b><br>Griso 1100 (8 valve) 07<br><b>MOTO MORINI</b><br>Corsaro 1200 Veloce 07<br><b>VOXAN</b><br>Black Magic 04-05<br>Street Scrambler 03-05<br>VB1-Evo 03-04<br>Cafe Racer 1000 02-06<br>Roadster 1000 02-06   | 320  |
|   | MD609ALS<br>MD609ARS | FRONT / REAR | F  | <b>LAVERDA</b><br>1000 RGS Corsa 84 |   | 280                |       |  |  |
| MD611<br>                          | REAR                 | F            | <b>BMW</b><br>K 75/75-S 90-96<br>K 75 RT 89-96<br>K 75 S 85-95<br>K 1000 82-88<br>K 100/2 87-90<br>K 100 LT 86-91<br>K 100 RS 83-89<br>K 100 RT 83-88<br>K 100 RS 89-92<br>K1 88-93<br>K 1100 LT 89-93   | 285                                 | MD615<br>                                  | REAR               | F     | <b>BMW</b><br>K 1200 LT 97-07<br>R 1200 CL 03-04   | 285  |
|   |                      |              |  |                                     |   | MD616LS<br>MD616RS | FRONT | S  | <b>BMW</b><br>R 850 R 04-06<br>K 1200 LT 00-06<br>R 1100 S 00-06<br>R 1150 GS 03-04<br>R 1150 R 01-06<br>R 1150 RS 01-04<br>R 1150 R Rockster 03-06<br>K 1200 R 05-07<br>K 1200 R Sport 07<br>R 1200 R Sport 06-07   |
| MD612RS<br>                        | FRONT                | F            | <b>APRILIA</b><br>AF 125 90-91   | 320                                 |   |                    |       |  |  |
| MD613<br>MD613C   | REAR                 | S            | <b>APRILIA</b><br>SL 1000 Falco 00-04<br>RSV 1000 Mille (All models) 99-07<br>Tuono 1000 (All models) 02-07<br><b>LAVERDA</b><br>SFC 1000 03-04  | 220                                 | MD617   | REAR               | S     | <b>CAGIVA</b><br>650 Raptor 01-07<br>1000 Raptor/V-Raptor 00-06<br>1000 Raptor/V-Raptor 00-05  | 220  |
|   |                      |              |  |                                     | MD618   | REAR               | S     | <b>DUCATI</b><br>749/749 S/749 R (All models) 03-06<br>999/999 S/999 R (All models) 03-06<br>Desmosedici RR (990cc) 07   | 240  |
| MD614LS<br>MD614RS<br>MD614C<br> | FRONT                | F            | <b>BENELLI</b><br>TRE-K 1130 06<br>Trek 899 07<br>2-UE (750cc) 07<br><b>CAGIVA</b><br>Planet 125 99-03<br>Mito 125 91-07<br>N1 125 97<br>Raptor 125 03-07<br>Supercity 125 92-00<br>Mito 500 07<br>River 600 94-<br><b>DUCATI</b><br>Hypermotard 07<br>400 Monster/Dark 00-04<br>600 Monster City/City Dark 99<br>600 Monster 00-01<br>620 IE/SIE Monster 02-04<br>Monster 620 Dark 03-04<br>748 Biposto 99-02<br>748 Testa Bassa 01<br>748 E<br>750 Supersport IE 00-02<br>750 Sport 01-02<br>750 Monster 00-01<br>Monster 800 IE/SIE 03-04<br>Supersport 800 03-04<br>900 Supersport IE 00-01<br>900 IE Monster 00-01<br>900 MH Evoluzione 00-01<br>900 Sport 02<br>Sport Touring ST4-916cc 99-02<br>Sport Touring ST2-944cc 97-02<br>Classic Sport Biposto (992cc) 07<br>STS 3 (992cc) 04-06<br>S2R (992cc) 06-07<br>Sport 1000 (992cc) 06-07<br>1000 DS Supersport 03-06<br>GT 1000 Sport (992cc) 06-07<br>Paul Smart 1000 Limited 06<br>Sport 1000 S (992cc) 07<br><b>KTM</b><br>690 SM Prestige 07<br><b>MOTO GUZZI</b><br>Nevada Classic 750 ie 05-07<br>Nevada 750 Touring 07<br>940 Custom 07<br>9 1/2 (998cc) 06<br>California Classic 1100 07<br>Fionda 1100 05 | 320                                 | MD619RS<br>                              | FRONT              | F     | <b>MZ/MUZ</b><br>Skorpion Tour/Traveller 95-02<br>Skorpion Sport/Cup 95-01   | 316  |
|   |                      |              |  |                                     |   | MD620LS<br>MD620RS | FRONT | S  | <b>BMW</b><br>F 800 S/ST 06-07<br>R 850 RT 06<br>K 1200 RS 01-04<br>K 1200 S (K40) 05-07<br>R 1100 S 00-03<br>R 1150 RT 00-04<br>K 1200 GT (K41) 03-06<br>K 1200 GT (K44) 06-07<br>R 1200 RT (K26) 03-07<br>R 1200 ST (K28) 03-07<br>R 1200 S 06-07<br>HP2 Megamoto 07 |
|   |                      |              |  |                                     | MD621LS<br>MD621RS<br>MD621C<br>         | FRONT              | F     | <b>APRILIA</b><br>RS 125 (Radial Caliper) 06-07<br>RSV Mille/Mille R 01-05<br>Pegaso Strada 650 05-06<br>Pegaso 650 Factory 07<br>Pegaso 650 07<br>SL 750 Shiver 07<br>NA 850 Mana 07<br>RSV 1000 (Radial Mount calipers) (All models) 03-07<br>Tuono 1000 (All models) 02-07<br><b>BENELLI</b><br>TNT 899 Tornado Naked Tre 07<br>Tornado TRE 1130 06<br>TNT 1130 Cafe Racer 06<br>TNT 1130 Titanium 06<br>Tornado Naked TRE 06<br>Tornado Tre 1130 06<br><b>BIMOTA</b><br>SB8K Santamonica<br><b>MONDIAL</b><br>Piega 1000 03-04<br>Evo 04<br><b>LAVERDA</b><br>SFC 1000 03-04<br><b>MOTO GUZZI</b><br>Griso 850 07<br>MGS-01 1000 cc 03-04<br>MGS-01 Corsa 07 | 320  |

D = Dished Solid Original (We replace with floating rotor conversion unit) F = Floating Rotor S = Solid Rotor  
SF = Solid Flat Original Disc which we replace with fully floating unit - fits direct no mods required.

# STREETBIKE DISC BUYERS GUIDE

| DISC No.  | FRONT/ REAR | TYPE | MODELS  | DIA (MM) | DISC No.  | FRONT/ REAR | TYPE | MODELS   | DIA (MM) |  |
|---|-------------|------|---|----------|---|-------------|------|--|----------|--|
| MD621LS<br>MD621RS<br>Contd.  | FRONT       | F    | <b>MOTO GUZZI</b><br>Griso 1100 05-07<br>1200 Sport 07  | 320      | MD633LS<br>MD633RS<br>MD633C  | FRONT       | F    | <b>DUCATI</b><br>748 Racing 99<br>748 R/RS/S 00<br>748 S 01-02<br>Monster S4 01-02<br>Monster S4R (996cc) 03-06<br>996 SPS/SPS II 99-00<br>996 00<br>Sport Touring ST4S 996cc 01-05<br>STS3 ABS 06-07<br>ST4S ABS 03<br>996/SPS 99-00<br>ST4 S 996 01<br>Monster S4 916 01<br><b>MOTO GUZZI</b><br>Brevia 850 07<br>Daytona (RS) 1000 93-97<br>Brevia 1100 05-06<br>V 1100 Brevia 04 | 320      |  |
| MD622LS/RS<br>                   | FRONT       | F    | <b>DUCATI</b><br>749/749 S/749 R (All models) 03-06<br>999/999 S/999 R (All models) 03-06   | 320      |                                        |             |      |  |          |  |
| MD623RS   | FRONT       | S    | <b>MZ/MUZ</b><br>Saxon 125 93-97<br>Saxon 150 95<br>251 Fun 95-96<br>Saxon "Tour" 251/301 93-98<br>Saxon 500 All models 93-98   | 280      |   |             |      |  |          |  |
| MD624LS<br>                      | FRONT       | F    | <b>DUCATI</b> STS 4 (996cc) (ABS) 03-05<br><b>MOTO GUZZI</b><br>Norge 850 07<br>Brevia 1100 (ABS) 07  | 320      |   |             |      |  |          |  |
| MD625LS   | FRONT       | S    | <b>APRILIA</b><br>Europa 50 90-92<br>AF1 Futura 50 90-92  | 290      | MD634LS<br>MD634RS<br>                 | FRONT /REAR | F    | <b>DUCATI</b><br>250/350/450 Desmo 74-77<br>750 Sport 74<br>750 SS 75-76<br>860 GT/GTS 75-76<br>900 GTS 75-76<br>900 SS Darmah 76-78<br><b>BENELLI</b><br>Tornado IE/Tornado Tre Novecento 03  | 280      |  |
| MD626RS<br>MD626RS<br>MD626C<br> | FRONT       | F    | <b>DUCATI</b><br>Monster S2R (803cc) 05-07<br>Multistrada 620 05-06<br>Monster 620 05-06<br>Monster Dark 620 05-06<br>695 Monster 06-07<br>S2R Dark (803cc) 06  | 300      | MD635RS<br>                            | FRONT       | F    | <b>APRILIA</b><br>AF1 125 87-89  | 320      |  |
| MD627<br>MD627C   | REAR        | S    | <b>DUCATI</b><br>695 Monster 06-07<br>Monster S2R (803cc) 05-07<br>S4R (998cc) 03-07<br>S4RS (998cc) 06-07<br>Multistrada 1000 03-06<br>Multistrada 1100 (1078c) 07<br>Multistrada 1100 S (1078cc) 07<br>S2R Dark (803cc) 06<br>S2R (992cc) 06-07   | 245      | MD636LS<br>MD636RS<br>               | FRONT       | F    | <b>BENELLI</b><br>Tornado Tre Novecento LE/RS 03-05<br><b>DUCATI</b><br>Monster 620 Catwoman 05<br>748 R 01-02<br>ST4-S (996cc) Non ABS 01-05<br>998 S 02<br>998 02<br><b>MOTO GUZZI</b><br>Brevia V1100 05  | 320      |  |
| MD628RS   | FRONT       | S    | <b>APRILIA</b><br>Classic 125 95-01<br>Red Rose 125 (Spoke wheel) 88-94   | 260      | MD637   | REAR        | S    | <b>TRIUMPH</b><br>Skorpion Tour/Traveller 95-02<br>Skorpion Sport/Cup 95-01<br>Skorpion Replica 95-01  | 240      |  |
| MD629LS<br>                    | FRONT       | F    | <b>TRIUMPH</b><br>Thruxton 04-07  | 320      | MD638   | REAR        | S    | Raptor 125 03-06<br>Super City 125 92-00<br>Mito 125 91-06<br>Planet 125 99-03<br>Mito 500 07  | 230      |  |
| MD630LS/RS  | FRONT       | S    | <b>DUCATI</b><br>750 Paso 87-90<br>750 Sport 88   | 280      | MD639LS   | FRONT       | S    | RS 50 (6 bolt fixing) 93-98  | 290      |  |
| MD631   | REAR        | S    | <b>DUCATI</b><br>750 Paso 87-90<br>750 Sport 88<br>906 Paso 88-89   | 270      | MD640LS<br>MD640RS<br>310mm disc<br> | FRONT       | F    | <b>TRIUMPH</b><br>Daytona 750 92<br>Daytona 900 93-96<br>Daytona Super 3 94-97<br>Speed Triple 94-97<br>Sprint 900 94-98<br>Trophy 900 94-01<br>Daytona 1000 92<br>Trophy 1200 94-01<br>Daytona 1200 93-98   | 310      |  |
| MD632<br>MD632C   | REAR        | S    | <b>DUCATI</b><br>748 SP/Biposto 95-98<br>748 Racing/SPS 98<br>748 Biposto 99<br>748 Racing 99<br>748 SPS 99<br>748 Biposto 00-02<br>748 R/RS/S 00<br>748 R 01-02<br>748 RS 01<br>748 S 01-02<br>748 Testa Bassa 01<br>748 E<br>900 MH Evoluzione 00-01<br>916 SP 94-96<br>916 Biposto-Senna 94-98<br>916 SPS (996cc) 98<br>996 98<br>996 SPS/SPS II 99-00<br>996 00<br>996 S 01<br>998 S 02<br>998 R 02<br>998 02 | 220      |   |             |      |  |          |  |

D = Dished Solid Original (We replace with floating rotor conversion unit) F = Floating Rotor S = Solid Rotor  
SF = Solid Flat Original Disc which we replace with fully floating unit - fits direct no mods required.

# STREETBIKE DISC BUYERS GUIDE

| DISC No.                         | FRONT/ REAR | TYPE | MODELS                                  | DIA (MM) | DISC No.                     | FRONT/ REAR | TYPE | MODELS                                       | DIA (MM) |
|----------------------------------|-------------|------|---|----------|------------------------------|-------------|------|--|----------|
| MD641                            | REAR        | S    | <b>TRIUMPH</b>                          | 255      | MD650LS/RS                   | FRONT       | S    | <b>BMW</b> (Select if left or right fitment) | 300      |
|                                  |             |      | Daytona 750 92                          |          |                              |             |      | F 650 All models 93-06                       |          |
| MD642LS                          | FRONT       | S    | <b>TRIUMPH</b>                          | 320      | MD651                        | REAR        | S    | <b>BMW</b>                                   | 240      |
|                                  |             |      | Adventurer 96-01                        |          |                              |             |      | F 650 All models 93-06                       |          |
| MD643                            | REAR        | S    | <b>TRIUMPH</b>                          | 285      | MD652LS<br>MD652RS<br>MD652C | FRONT       | S    | <b>BMW</b>                                   | 305      |
|                                  |             |      | Thunderbird 95-02                       |          |                              |             |      | F 650 Xchallenge 07                          |          |
| MD644LS<br>MD644RS               | FRONT       | S    | <b>TRIUMPH</b>                          | 276      | MD653<br>MD653C              | REAR        | S    | <b>BMW</b>                                   | 276      |
|                                  |             |      | Legend TT 98-01                         |          |                              |             |      | F 650 Xcountry 07                            |          |
| MD645                            | REAR        | S    | <b>TRIUMPH</b>                          | 255      | MD657LS<br>MD657RS           | FRONT       | D    | <b>BMW</b>                                   | 260      |
|                                  |             |      | Speedmaster (865cc) 05-07               |          |                              |             |      | R 1200 RS 96-00                              |          |
| MD646LS<br>MD646RS<br>296mm Disc | FRONT       | F    | <b>TRIUMPH</b>                          | 296      | MD658                        | REAR        | S    | <b>BMW</b>                                   | 260      |
|                                  |             |      | Tiger 900 885cc 92-97                   |          |                              |             |      | R 850 R 94-02/06                             |          |
| MD647LS<br>MD647RS<br>MD647C     | FRONT       | F    | <b>TRIUMPH</b>                          | 320      | MD659                        | REAR        | S    | <b>BMW</b>                                   | 220      |
|                                  |             |      | HONDA                                   |          |                              |             |      | R 850 RT 96-01                               |          |
| MD648<br>MD648C                  | REAR        | S    | <b>TRIUMPH</b>                          | 220      | MD660LS<br>MD660RS           | FRONT       | F    | <b>BMW</b>                                   | 285      |
|                                  |             |      | CBR 125 R4/R5/RW5/RS5/RS6 /RR6/R7 04-07 |          |                              |             |      | R 1100 GS 93-99                              |          |
| MD649LS<br>MD649RS               | FRONT       | S    | <b>TRIUMPH</b>                          | 310      | MD661                        | REAR        | F    | <b>BMW</b>                                   | 285      |
|                                  |             |      | CBR 150 R 00-03                         |          |                              |             |      | R 1100 R 93-01                               |          |
| MD649LS<br>MD649RS               | FRONT       | S    | <b>TRIUMPH</b>                          | 310      | MD662LS/RS<br>MD662C         | FRONT       | F    | <b>BMW</b>                                   | 310      |
|                                  |             |      | CBF 250 4/7 04-07                       |          |                              |             |      | R 1150 GS 98-04                              |          |
| MD649LS<br>MD649RS               | FRONT       | S    | <b>TRIUMPH</b>                          | 310      | MD662LS/RS<br>MD662C         | FRONT       | F    | <b>BMW</b>                                   | 310      |
|                                  |             |      | Speedmaster (865cc) 05-07               |          |                              |             |      | R 1150 R 01-06                               |          |
| MD649LS<br>MD649RS               | FRONT       | S    | <b>TRIUMPH</b>                          | 310      | MD662LS/RS<br>MD662C         | FRONT       | F    | <b>BMW</b>                                   | 310      |
|                                  |             |      | Thunderbird Sport 98-00                 |          |                              |             |      | R 1150 RS 01-06                              |          |
| MD649LS<br>MD649RS               | FRONT       | S    | <b>TRIUMPH</b>                          | 310      | MD662LS/RS<br>MD662C         | FRONT       | F    | <b>BMW</b>                                   | 310      |
|                                  |             |      | Tiger 855i (From VIN 71699) 98-88       |          |                              |             |      | R 1150 RT 00-04                              |          |
| MD649LS<br>MD649RS               | FRONT       | S    | <b>TRIUMPH</b>                          | 310      | MD662LS/RS<br>MD662C         | FRONT       | F    | <b>BMW</b>                                   | 310      |
|                                  |             |      | Tiger 900 885cc 97-99                   |          |                              |             |      | R 1150 Rockster 03-06                        |          |
| MD649LS<br>MD649RS               | FRONT       | S    | <b>TRIUMPH</b>                          | 310      | MD662LS/RS<br>MD662C         | FRONT       | F    | <b>BMW</b>                                   | 310      |
|                                  |             |      | Tiger 955cc Spoke wheel 99-04           |          |                              |             |      | R 1200 CL 03                                 |          |
| MD649LS<br>MD649RS               | FRONT       | S    | <b>TRIUMPH</b>                          | 310      | MD662LS/RS<br>MD662C         | FRONT       | F    | <b>BMW</b>                                   | 310      |
|                                  |             |      | Speedmaster (865cc) 05-07               |          |                              |             |      | R 1200 C 96-04                               |          |
| MD649LS<br>MD649RS               | FRONT       | S    | <b>TRIUMPH</b>                          | 310      | MD662LS/RS<br>MD662C         | FRONT       | F    | <b>BMW</b>                                   | 310      |
|                                  |             |      | Thunderbird Sport 98-00                 |          |                              |             |      | R 1200 CL 03                                 |          |
| MD649LS<br>MD649RS               | FRONT       | S    | <b>TRIUMPH</b>                          | 310      | MD662LS/RS<br>MD662C         | FRONT       | F    | <b>BMW</b>                                   | 310      |
|                                  |             |      | Tiger 855i (From VIN 71699) 98-88       |          |                              |             |      | R 1200 CL 03                                 |          |
| MD649LS<br>MD649RS               | FRONT       | S    | <b>TRIUMPH</b>                          | 310      | MD662LS/RS<br>MD662C         | FRONT       | F    | <b>BMW</b>                                   | 310      |
|                                  |             |      | Tiger 900 885cc 97-99                   |          |                              |             |      | R 1200 CL 03                                 |          |
| MD649LS<br>MD649RS               | FRONT       | S    | <b>TRIUMPH</b>                          | 310      | MD662LS/RS<br>MD662C         | FRONT       | F    | <b>BMW</b>                                   | 310      |
|                                  |             |      | Tiger 955cc Spoke wheel 99-04           |          |                              |             |      | R 1200 CL 03                                 |          |





D = Dished Solid Original (We replace with floating rotor conversion unit) F = Floating Rotor S = Solid Rotor  
SF = Solid Flat Original Disc which we replace with fully floating unit - fits direct no mods required.

# STREETBIKE DISC BUYERS GUIDE

| DISC No.                     | FRONT/ REAR | TYPE | MODELS  | DIA (MM) | DISC No.           | FRONT/ REAR | TYPE | MODELS  | DIA (MM) |
|------------------------------|-------------|------|---|----------|--------------------|-------------|------|---|----------|
| MD663                        | REAR        | S    | <b>TRIUMPH</b>  | 255      | MD675LS<br>MD675RS | FRONT       | F    | <b>MV AGUSTA</b>  | 310      |
|                              |             |      | Daytona 650 05<br>Bonneville 800 01-06<br>Bonneville T100 02-07<br>Bonneville/Bonneville Black 07<br>Scrambler (865cc) 06-07<br>Sprint ST 99-07<br>Sprint RS 99-04<br>Thruxton 900 04-07<br>Tiger 1050 07   |          |                    |             |      | F4 750 99-03<br>Brutale 750 S 03-06<br>Brutale 910 S 05-07<br>Brutale 910 Standard 05-07<br>F4 1000 04-06                                 |          |
| MD664                        | REAR        | S    | <b>APRILIA</b>  | 220      | MD676LS<br>MD676RS | FRONT       | F    | <b>TRIUMPH</b>  | 310      |
|                              |             |      | RS 50 99-06<br>Tuono 50 03-04<br>RS 125 96-07<br>Tuono 125 03-04  |          |                    |             |      | Tiger 955 From VIN 198875 04-06   |          |
| MD665                        | REAR        | S    | <b>APRILIA</b>  | 220      | MD677              | REAR        | S    | <b>TRIUMPH</b>  | 285      |
|                              |             |      | RS 250 95-02  |          |                    |             |      | Tiger 955 From VIN 198875 04-06   |          |
| MD666LS<br>MD666RS<br>MD666C | FRONT       | F    | <b>APRILIA</b>  | 320      | MD678LS<br>MD678RS | FRONT       | F    | <b>VICTORY</b>  | 300      |
|                              |             |      | RSV 1000 All models 98-99<br>RSV 1000 Mille SP 99<br>SL 1000 'Falco' 00-04<br><b>CAGIVA</b><br>Raptor X3 1000 03-04   |          |                    |             |      | Victory Models 03-07  |          |
| MD667LS/RS                   | FRONT       | F    | <b>MOTO GUZZI</b>   | 299      | MD678              | REAR        | F    | <b>VICTORY</b>  | 300      |
|                              |             |      | Daytona 1000 92-95  |          |                    |             |      | Victory Models 03-07  |          |
| MD668LS/RS                   | FRONT       | F    | <b>LAVERDA</b>  | 299      | MD679LS<br>MD679RS | FRONT       | S    | <b>TRIUMPH</b>  | 320      |
|                              |             |      | 1000 SFC 85-86  |          |                    |             |      | Speed Triple 1050cc 06-07<br>Tiger 1050 07  |          |
| MD669LS<br>MD669RS<br>MD669C | FRONT       | F    | <b>TRIUMPH</b>  | 320      | MD680LS<br>MD680RS | FRONT       | F    | <b>KTM</b>  | 305      |
|                              |             |      | Sprint ST (1050cc) 05-07<br>Speed Triple 01-02<br>Daytona 955i 01-02<br>Daytona 955i 06<br>Rocket 111 2300 04-07<br>Rocket 111 Classic 07   |          |                    |             |      | SMC 950 Supermoto 05-06   |          |
| MD670                        | FRONT/REAR  | S    | <b>LAVERDA</b>  | 280      | MD681              | REAR        | S    | <b>KTM</b>  | 240      |
|                              |             |      | Bolt On - Ring Only   |          |                    |             |      | 690 Supermoto 07<br>690 SM Prestige 07<br>SMC 950 Supermoto 05-06<br>950 R Superenduro 06-07<br>990 Superduke 05-06<br>990 Superduke R 07 |          |
| MD671                        | REAR        | S    | <b>BMW</b>  | 265      | MD682LS<br>MD682RS | FRONT       | S    | <b>DUCATI</b>   | 320      |
|                              |             |      | F 800 S/ST 06-07<br>HP 1200 05-06<br>R 1200 GS 04-06<br>K 1200 S (K40) 05-07<br>K 1200 R Sport 07<br>R 1200 R 05-07<br>R 1200 RT (K26) 03-07<br>R 1200 ST (K28) 03-07<br>R 1200 S 06-07<br>R 1200 R Sport 06-07<br>R 1200 GS Adventure 07<br>HP2 Megamoto 07<br><b>MBK</b><br>X Power 03-06 |          |                    |             |      | Multi Strada 1000 DS/1000 S DS 03-06<br>Multistrada 1100 (1078cc) 07<br>Multistrada 1100 S (1078cc) 07                                    |          |
| MD672LS                      | FRONT       | S    | <b>APRILIA</b>  | 280      | MD684LS/RS         | FRONT       | F    | <b>NORTON</b>   | 320      |
|                              |             |      | RS 50 (5 bolt fixing) 99-06<br>Tuono 50 04<br><b>YAMAHA</b><br>TZR 50 03-07   |          |                    |             |      | F1 (Rotary) - P55 Model 90-91   |          |
| MD673LS                      | FRONT       | F    | <b>APRILIA</b>  | 296      | MD685LS            | FRONT       | S    | <b>APRILIA</b>  | 300      |
|                              |             |      | Moto 6.5 95-01  |          |                    |             |      | RS 50 (Radial Caliper) 07<br><b>DERBI</b><br>GPR 50/Nude 04-07<br>Freexter 125 07<br>GPR 125/Nude 04-07<br><b>GILERA</b><br>SC 125 06-07  |          |
| MD674                        | REAR        | S    | <b>APRILIA</b>  | 220      | MD686              | REAR        | S    | <b>APRILIA</b>  | 180      |
|                              |             |      | Moto 6.5 95-01  |          |                    |             |      | RS 50 (Radial Caliper) 07<br><b>DERBI</b><br>GPR 50/Nude 04-06<br>GPR 125/Nude 04-06<br><b>GILERA</b><br>SC 125 06-07                     |          |
|                              |             |      |   |          | MD687              | FRONT       | S    | R 1200 GS 04-07<br>R 1100 S 96-00<br>R 1200 GS Adventure 07   | 320      |
|                              |             |      |   |          |                    |             |      |   |          |
|                              |             |      |   |          | MD688              | REAR        | S    | K 1200 GT (K44) 06-07   | 294      |
|                              |             |      |   |          |                    |             |      |   |          |
|                              |             |      |   |          | MD689              | REAR        | S    | <b>HYOSUNG</b>  | 230      |
|                              |             |      |   |          |                    |             |      | GT 125 R 06-07<br>GT 650 06-07<br>GT 650 X 07<br><b>SUPERBYKE</b><br>R-SR 250   |          |
|                              |             |      |   |          | MD690LS<br>MD690RS | FRONT       | F    | <b>HYOSUNG</b>  | 300      |
|                              |             |      |   |          |                    |             |      | GT 125 R 06-07<br>GT 650 06-07<br><b>SUPERBYKE</b><br>R-SR 250  |          |

D = Dished Solid Original (We replace with floating rotor conversion unit) F = Floating Rotor S = Solid Rotor  
SF = Solid Flat Original Disc which we replace with fully floating unit - fits direct no mods required.

# STREETBIKE DISC BUYERS GUIDE

| DISC No.  | FRONT/ REAR  | TYPE | MODELS   | DIA (MM) | DISC No. | FRONT/ REAR  | TYPE | MODELS   | DIA (MM) |  |
|---|--|------|--|----------|----------|--------------|------|--|----------|--|
| MD692   | REAR   | S    | <b>MOTO GUZZI</b><br>California Jackel 1100 99-01<br>California Special 1100 99-01<br>California Classic 1100 07<br>V11 (All models) 99-06<br>Le Mans (All models) 01-04<br>California Stone/Metal/Touring Stone 02-06<br>California EV/Special /Touring/Custom Touring 02-06<br>Norge 1200 (ABS) All models 06-07<br>1200 Sport 07  | 282      | MD901D   | FRONT & REAR | S    | <b>PEUGEOT</b><br>Street Board/Trekker (All models) 98-06<br>Looxor 100 01-04<br>Looxor 125/150 03-04<br>Vivacity 50/100 (All models) 99-07<br>Ludix Elegance 50cc 04<br>Ludix Ambition 125cc 04-05<br>TKR 06-07<br><b>PIAGGIO</b><br>Quartz 50 92-96  | 190      |  |
| MD693   | REAR   | F    | <b>MOTO GUZZI</b><br>750 SP 90-92<br>Nevada 750 91-92<br>1000 Le-Mans 84-93<br>Strada 1000 93-94<br>California 1100 94-97  | 270      | MD902D   | FRONT        | S    | <b>PIAGGIO</b><br>Skipper 125/150 94-97<br><b>MALAGUTI</b><br>Centro SL/SL CAT 94-00   | 200      |  |
| MD694LS<br>MD694RS<br>MD694C  | FRONT<br> | F    | <b>DUCATI</b><br>1098/1098 S/1098 Tricolore 07   | 330      | MD903D   | FRONT        | S    | <b>YAMAHA</b><br>YP 250 DX/A 'Majesty' 98-00<br>YP 250 Majesty 96-02<br>YP 250 Skyliner 96-98<br>YP 250 Skyliner 250 (+ABS) 00-03<br><b>MBK</b><br>YP 250 Skyliner 96-00   | 245      |  |
| MD695<br>MD695C   | REAR   | S    | <b>DUCATI</b><br>1098/1098 S/1098 Tricolore 07   | 245      | MD904D   | FRONT        | S    | <b>ADLY</b><br>Road Tracker 50/90/100 04-06<br><b>APRILIA</b><br>Amico (All models) 93-<br><b>GARELLI</b><br>Queenie 95-<br>Grinta 95-<br><b>GILERA</b><br>Easy Moving 50 95-96<br><b>JORDAN</b><br>Easy 50/100 03-04<br><b>MBK</b><br>CR 50 Z Target 91-95<br>CW 50 R Booster Road 94-95<br>CV 50 Evolis 97<br>CY 50 Forte/Forte Mufa 96-97<br>YA 50 R Forte 94-95<br>YE 50 Evolis 92-95<br>YM 50 Fizz 94-95<br>CV 80 Evolis 97<br><b>MOTO-ROMA</b><br>Go-Go 50 97-05<br>Stinger 50 99-05<br>Scrambler 50 01<br>Roadrunner 50/100 01-02<br><b>MUZ</b><br>Moskito FB50 97-03<br>Moskito SX JP50 00-03<br><b>PIAGGIO</b><br>Zip Fast Raider 93-97<br>Zip 50 Base 95-96<br>Zip 50 RST 96-99<br>Zip 50 Elettrico 02<br><b>PEUGEOT</b><br>Scooters with Leleu wheels disc attached with countersunk bolts<br>Ludix Snake/Bullet/Trend 50cc 04<br><b>P.G.O.</b><br>Big max 50/90 94-06<br>EPS 97<br>Tornado 50/125 97<br><b>SUPERBYKE</b><br>M-Ped 50 Road Classic<br><b>YAMAHA</b><br>CR-Z 50 (3WN) 91-95<br>YA 50 R Axis (4pc) 95-96<br>YE 50 Zest 93-95<br>YM 50 Breeze (4KH) 94-95<br>Jog 'R' 91- | 155      |  |
| MD711LD<br>MD711RD  | FRONT  | F    | <b>YAMAHA</b><br>TZ 125 94-97<br>TZ 250 89-97  | 282      |          |              |      |  |          |  |
| MD719LS/RS<br>   | FRONT  | F    | <b>BUELL</b> All models (Countersunk fixing) 94-99   | 340      |          |              |      |  |          |  |
| MD722LD<br>MD722RD  | FRONT  | F    | YZF-R7 750 'OWO2' (Race version) 320   | 320      |          |              |      |  |          |  |
| MD727LS/RS<br> | FRONT  | F    | <b>VICTORY</b><br>Victory Models 98-04   | 300      |          |              |      |  |          |  |
| MD727<br>REAR   | REAR   | F    | Victory Models 98-04   | 98-04    |          |              |      |  |          |  |
| MD730LD<br>MD730RD  | FRONT  | F    | <b>YAMAHA</b><br>TZ 250 98-05  | 298      |          |              |      |  |          |  |
| MD732   | REAR   | S    | <b>YAMAHA</b><br>TZ 250 98-05  | 185      |          |              |      |  |          |  |
| MD734RS<br>    | FRONT  | F    | <b>HARLEY DAVIDSON</b><br>M2 Cyclone, X1 Lightning 00-05   | 340      |          |              |      |  |          |  |
| MD901D<br>With counter sunk bolt holes  | FRONT & REAR   | S    | <b>ATALA</b><br>Hacker (LC) 97<br>Hacker (Racing) 97<br>Hacker 97<br><b>BETA</b><br>Eickon 50 99-06<br>Quadra 50 97-00<br>Tempo 50 98-02<br>ARK 1 LC/AC 97-07<br><b>HONDA</b><br>SJ 50 P/R/S/T/V/W/X 'Bali' 93-99<br>SJ 100 T/W/X 'Bali Ex' 96-99<br><b>MALAGUTI</b><br>Ciak 50/100 00-03<br>Phantom F12 50 (LC) 94-07<br>F12 50 Phantom 98<br>Firefox F15 96-03<br>Crosser CR1 97-01<br>F15 RR 99-01<br>F15 Firefox 01-05<br>F15 Firefox Kat 98-00<br><b>MBK</b><br>Ciak 50 Twin Disc<br>Ciak 100 99-01<br><b>PEUGEOT</b><br>Scooters with Grimeca Wheels<br>Disc attached with countersunk bolts<br>Elyseo 50 98-02<br>Looxor 50 TSDi 06<br>Metal-X 50 02-03<br>SV 100 L | 190      |          |              |      |  |          |  |
|   |  |      |  |          | MD905D   | FRONT        | S    | <b>PIAGGIO</b><br>Hexagon 125/150 94-97  | 175      |  |
|   |  |      |  |          | MD906D   | FRONT        | S    | <b>CAGIVA</b><br>City 50 92-<br><b>HONDA</b><br>SFX 50 'S/T/V/W/X/Y/1' 95-04<br>SXR 50 W/SW/X/SX 98-99   | 160      |  |

D = Dished Solid Original (We replace with floating rotor conversion unit) F = Floating Rotor S = Solid Rotor  
SF = Solid Flat Original Disc which we replace with fully floating unit - fits direct no mods required.



# STREETBIKE DISC BUYERS GUIDE

| DISC No.                          | FRONT/ REAR | TYPE | MODELS   | DIA (MM) | DISC No.   | FRONT/ REAR | TYPE  | MODELS   | DIA (MM) |
|-----------------------------------|-------------|------|--|----------|--|-------------|---|--|----------|
| MD907D                            | FRONT       | S    | <b>YAMAHA</b><br>YP 125 Majesty 98-06<br>XN 125 N Teo's 00-03  | 220      | MD916D   | FRONT       | S   | <b>YAMAHA</b><br>BWS 50 Original 99-02<br>CW 50 RS (4YA1/2/BWS) 96-97<br>CW 50 RS (4YA4/BWS NG) 98<br>CW 50 (5WW4/BWS) 05<br>CW 50 RSP (5CC1/3/4YA BWS Spy) 97-98  | 180      |
|                                   |             |      | <b>MBK</b><br>XN 125/150 Doo Do 00-05<br>YP 125 D Skyliner 98-06   |          |  |             |   | <b>GARELLI</b> FLO 50<br><b>MBK</b><br>CW 50 RS Booster (All models) 95-06<br>CW 50 Fizz 50 93-97<br>CW 50 Booster 06<br>CW 50 Power Rocket 06   |          |
| MD908D                            | FRONT       | S    | <b>HONDA</b><br>CN 250 H/J/L/M/P/R/S/T/V/X<br>SPAZIO/Helix 87-98<br>CN 250 3 Fusion/Fusion X/<br>Fusion X Special 03   | 186      | MD917D   | FRONT       | S   | <b>APRILIA</b><br>Scarabeo 50 93-97  | 220      |
| MD909D<br>With counterbored holes | FRONT REAR  | S    | <b>BENELLI</b><br>491 98-04<br>K2 50/100 98-01<br>Naked 50/100 02-03   | 190      | MD918D   | FRONT       | S   | <b>HONDA</b><br>SH 50 T/X/W/X/Y/1 'Fifty /Scoopy' 97-03<br>SH 100 T/W/X/Y/1 Scoopy 96-01   | 220      |
|                                   |             |      | <b>KEEWAY</b><br>Matrix 25/50 06<br>Matrix 125 06<br><b>PEUGEOT</b><br>Scooter with Leleu wheels discs attached with counterbored bolts<br>Ludix Elegance 50cc 04<br>Ludix Ambition 125cc 04   |          | MD919D   | FRONT       | S   | <b>HONDA</b><br>SK 50 MM-II/MM-YD/MN-II /MP-II (AF28) Dio SR<br>SK 50 MN-III/MP-III/MP-IV (AF28) Dio ZX<br>SK 50 MMR-II/MMT-II (AF28) Dio XR   | 160      |
| MD910D                            | FRONT       | S    | <b>PIAGGIO</b><br>Fly 50 (2T/4T) 05-07<br>Free 50 95-02<br>Sfera 50 RST 95-97<br>Zip 50 SP (L/C) 96-06<br>Free Delivery 50 00-02<br>Free 100 02<br>Fly 125/150 05-07<br>Sfera 125 95-97<br>Vespa ET4 125 96-99<br>Hexagon LX 180 98-99<br>Hexagon LXT 180 98-99<br>Hexagon LX4 125 98-99<br>Super Hexagon GTX 125/180 00<br>Zip 125 00-04<br>Hexagon GT 250 98-99<br>Super Hexagon GTX 250 00-02<br><b>GILERA</b> Ice 50 01-03 | 200      | MD920D   | FRONT       | S   | <b>HONDA</b><br>SZX 50 Super Sport Scooter X8R-SW/SX/SY/S1 98-04<br>SZX 50 XW Cross Sport X8R-XW/XX/XY/X1 98-04<br>PS 125 i 6/7 06-07  | 220      |
|                                   |             |      | <b>LML</b><br>Star 125 DLX<br><b>VESPA</b><br>LX 50 (2T & 4T) 05-07<br>Vespa ET2 50 97-05<br>Vespa ET4 50 00-04<br>LX 60 (Special Anniversary Model) 06<br>LX 125/150 (4T) 05-07<br>Vespa PX 125/150/200 98-07<br>Vespa ET4 125/150 99-05  |          | MD921D   | REAR        | S   | <b>HONDA</b><br>SZX 50 SW X8R-SW/SX/SY/S1 'Super Sport Scooter' 98-04<br>SZX 50 XW X8R-XW/XX/XY/X1 'Cross Sport' 98-04   | 190      |
| MD910D                            | REAR        | S    | <b>GILERA</b><br>DNA 50 01-06<br>Runner VX 125/180 01-04<br><b>PIAGGIO</b><br>Fly 100 07<br>Zip 100 07<br>Super Hexagon GTX 125/180 00   | 240      | MD922D   | FRONT       | S   | <b>HONDA</b><br>FES 125/150 W/Y/1-7 'Pantheon' 98-07<br>FES 250 W/X/Y/1/2/5 'Foresight' 98-05<br>NSS 250 Y/AY/1/A1/A3/3 Forza /Forza-S/Forza-T/Forza-ST/Jazz /Reflex (MF04/MF06) 00-04<br>NSS 250 EX5/EX6 Forza EX (ABS) 05-06<br>NSS 250 AX5/AX6 (Forza Z) (ABS) 05-06<br>PS 250 5/6 Big Ruckus 05-06<br><b>PEUGEOT</b><br>SV 250 01-02                         | 190      |
|                                   |             |      | <b>MD911D</b>  |          | FRONT  | S           | <b>SUZUKI</b><br>TR 50 SW/SX 98-00<br>UG 110 W/SW/Y/SY/SK1 Hokuto/Address 98-02<br>AN 125 S/T/V/W/X 95-00 | 180  |          |
| MD912D                            | FRONT       | S    | <b>SUZUKI</b><br>AH 100 P Address 95-96  | 161      | MD923D   | FRONT       | S   | <b>YAMAHA</b><br>YQ 50 'Aerox' R 97-07<br>YQ 100 "Aerox 100" 00-04<br>EW 50 "Slider" 00-05<br>BWS 50 Next Generation 99-07<br><b>ADLY</b><br>Activator/Thunderbike 125<br>Predator 50/100<br>SS 50/100 1/11 Supersonic 04-05<br>SS 125 B/D Supersonic 04-05<br><b>CPI</b><br>Baby J 50 02<br>Popcorn 50 02-06<br>Oliver 50 (All models) 03-06<br>Hussar 50 03-06 | 190      |
| MD913                             | FRONT       | S    | <b>HONDA</b><br>CH 250 F/G Spacy 85-86   | 170      |  |             |   |  |          |
| MD914                             | FRONT       | S    | <b>PEUGEOT</b><br>Scooter with Grimeca wheels discs attached with countersunk bolts<br>Ludix Snake/Bullet/Trend 50cc 04  | 155      | <b>GARELLI</b><br>FX 50<br>KRS 50<br>Freeland 125/150<br><b>GENERIC</b><br>XOR 50 05-07<br>Ideo 50 05-07<br>XOR 125 05-07<br><b>HONDA</b><br>SJ 50 P/R/S/T/V/W/X 'Bali' 93-99<br>SJ 100 T/W/X 'Bali Ex' 96-99<br><b>MBK</b><br>Nitro 98-01<br>CW 50 RS Booster NG 01-06<br>EW 50 Stunt 00-06<br>EW 50 Stunt Naked 05-06<br>YQ 50 Nitro 97-06<br>YQ 100 Nitro 01-03 |             |   |  |          |
| MD915D                            | FRONT       | S    | <b>MALAGUTI</b><br>F10 Jet Line/Jet Line WAP 96-07<br>Yesterday 98-03  | 155      |  |             |   |  |          |

D = Dished Solid Original (We replace with floating rotor conversion unit) F = Floating Rotor S = Solid Rotor  
SF = Solid Flat Original Disc which we replace with fully floating unit - fits direct no mods required.

# STREETBIKE DISC BUYERS GUIDE

| DISC No. | FRONT/ REAR | TYPE | MODELS  | DIA (MM) | DISC No. | FRONT/ REAR | TYPE | MODELS   | DIA (MM) |
|----------|-------------|------|---|----------|----------|-------------|------|--|----------|
| MD923D   | FRONT       | S    | <b>MOTO ROMA</b><br>Grand Prix 50/100 99-03<br>Grand Prix 125 02<br><b>BSM</b><br>TB 100<br>TB 125<br>FT 125<br><b>TGB</b><br>Delivery 50 06-07<br>Key West 50 06-07<br>RS 50cc 06-07<br>Sunset 50 07<br>Trigger 50<br><b>TGB</b><br>High Wheel 50<br>F409 Cruise 50/125<br>Sunset 150 07<br><b>P.G.O.</b><br>T-Rex All models 99-05<br>PMX 50/110 00-03<br>Charge 125 A/B 01-02<br>Ligero 125 06 | 190      | MD931D   | FRONT       | S    | <b>HONDA</b><br>SGX 50 V/W/X/Y/1 'Sky' 97-03<br>SRX 50 T/W/X 97-99<br>SRX 90 T/W/X 97-99   | 190      |
|          | REAR        |      | <b>YAMAHA</b><br>CW 50 RS (5FXA/VG5SA BWS) 99<br>CW 50 RS (5FXJ/VG5SA BWS) 00<br>CW 50 RS (5FXM/VG5SA BWS) 01-05<br>CW 50 (5MS2/4G54R) 02<br>YQ 50 'Aerox' R 97-07<br><b>BSM</b><br>TB 125<br><b>MBK</b><br>YQ 50 Nitro 97-05   |          | MD932D   | FRONT/ REAR | S    | <b>GILERA</b><br>50 DD/SP 'Runner/Purejet' 98-05<br>Runner 50 PJ/SP 06-07<br>Stalker 50 97-06<br><b>DERBI</b><br>GP-1 50 01-Feb 05<br>GP1 50 Open 06-07<br><b>PIAGGIO</b><br>NRG 50 RST (DD/DT) MC2 98<br>NRG 50 Extreme 99-01<br>NRG 50 MC3 DD 01-05<br>NRG 50 DD 06<br>NRG 50 Pure Jet 06-07<br>Zip 50 (A/C) 00-07   | 175      |
| MD924D   | FRONT       | S    | <b>PIAGGIO</b><br>NRG 50 Extreme 99-01<br>NRG 50 DT MC3 01-05<br>NRG 50 MC3 DD 01-04<br>Skipper LX 125/150 98-99<br>Skipper ST 125/150 4T 00-04<br><b>BENELLI</b><br>Adiva 125/150 00<br><b>DERBI</b><br>Boulevard 125/200/150 03-07<br><b>GILERA</b><br>50 DD/SP Runner/Purejet 98-05<br>125/180 Runner All models 98-04<br>125 VX 4T/180 VXR 4T 01-04<br>VXR 200 Runner (4T) 02-04              | 220      | MD933D   | FRONT       | S    | <b>CAGIVA</b><br>City 50 91-94<br><b>KYMCO</b><br>CX 50 Super (PR 50 AC) 94-97<br>Heroism 50 95-00<br>Sniper 50 (PR 50 B) 93<br>Sniper 50 DD (PR 50 BB) 94-96<br>KB 100 Manboy 97-00<br>Heroism 125 (SE25BA) 95-97<br>Heroism 150 (SE30AD) 95-97<br><b>SYM</b><br>City Hopper 60 96-06<br>MIO 50/100 05-07<br>Super Fancy 50 96-06<br>Attila 125 99-00<br>Megalo 125 00-07 | 160      |
| MD925D   | FRONT/ REAR | S    | <b>PEUGEOT</b><br>50/100 Speed Fight 97-07<br>Elyseo 50 03<br>Elyseo 100 03   | 180      | MD934D   | FRONT       | S    | <b>SUZUKI</b><br>UC 125 X/Y 99-02<br><b>KAWASAKI</b><br>SC 150 A1 (Epsilon 150) 02-03  | 220      |
| MD926D   | REAR        |      | <b>KYMCO</b><br>Sniper 50 DD 94-96<br>Heroism 150 (SE30AD) 95-97  |          | MD935D   | FRONT       | S    | <b>APRILIA</b><br>Sonic (All models) 98-07   | 155      |
| MD927D   | REAR        | S    | <b>YAMAHA</b><br>YP 250 Majesty 98-99<br><b>MBK</b><br>YP 250 Skyliner 98-99  | 230      | MD936D   | FRONT       | S    | <b>APRILIA</b><br>Area 51 98-02  | 190      |
| MD928D   | FRONT       | S    | <b>YAMAHA</b><br>YH 50 'Why' 98-07<br><b>MBK</b> YH 50 Flipper 98-06  | 220      | MD936D   | REAR        |      | <b>MALAGUTI</b><br>F12 50 Phantom 98-03<br>Phantom F69 (70cc) 98   |          |
| MD929D   | FRONT       | S    | <b>SUZUKI</b><br>AN 250 K1/K2 Burgman 01-02<br>AN 250 W/X/Y 'Burgman' 98-03<br>AN 400 X/Y/K1/K2 'Burgman' 99-02<br><b>KAWASAKI</b><br>SC 250 A1 (Epsilon 250) 02  | 260      | MD937D   | FRONT       | S    | <b>SUZUKI</b><br>AP 50 R/S/T/V/W 96-02   | 180      |
| MD930D   | REAR        | S    | <b>SUZUKI</b><br>AN 250 K1/K2 Burgman 01-02<br>AN 250 W/X/Y/K1/K2 'Burgman' 98-02<br>AN 400 X/Y/K1/K2 'Burgman' 99-02<br><b>KAWASAKI</b><br>SC 250 A1 (Epsilon 250) 02-03   | 210      | MD938D   | FRONT       | S    | <b>SUZUKI</b><br>AY 50 V/W/WV/WW/WX/WY/WRW<br>/WRX/WRY/WRK1/WRK2/WRK3<br>/K1/K2/K3/K4/WRK4/AK5 'Katana' 97-05<br>UF 50 Y 00-02<br>UX 50 WX/WY 99-02  | 180      |
|          |             |      |   |          | MD939D   | FRONT       |      | <b>SUZUKI</b><br>AH 80 Address 92-94<br>AH 100 Address 92-94   |          |
|          |             |      |   |          | MD940D   | REAR        | S    | <b>SUZUKI</b><br>AY 50 WRX/WX/WRY/WY/WRK1/WRK3<br>/WRK4/AK5 'Katana' 99-05   | 190      |
|          |             |      |   |          | MD941D   | FRONT       | S    | <b>ITALJET</b><br>Dragster 50LC 98-07<br>Formula 50/125 LC 96-02<br>Formula 50 Air 99-02<br>Dragster 125/180 LC 99-02<br>Dragster 250 07<br>Formula 50/125 LC 96-02  | 175      |
|          |             |      |   |          | MD942D   | FRONT       | S    | Leonardo 125/150 ST/SP 96-04<br>Leonardo 125 05-06<br>Leonardo 250 ST/SP 00-04<br>Scarabeo 125/150/GT 99-04<br>Scarabeo 250 06<br>Leonardo 300 05-06   | 220      |

D = Dished Solid Original (We replace with floating rotor conversion unit) F = Floating Rotor S = Solid Rotor  
SF = Solid Flat Original Disc which we replace with fully floating unit - fits direct no mods required.

# STREETBIKE DISC BUYERS GUIDE

| DISC No. | FRONT/ REAR | TYPE | MODELS   | DIA (MM) | DISC No. | FRONT/ REAR | TYPE | MODELS  | DIA (MM) |
|----------|-------------|------|--|----------|----------|-------------|------|---|----------|
| MD942D   | REAR        |      | Scarabeo 125/250/G6 04-06<br>Scarabeo 125/200 03<br>Sport City 125/200 04-07<br><b>DERBI</b><br>Boulevard S125 07  |          | MD952D   | FRONT       | S    | <b>APRILIA</b><br>Scarabeo 125/150/GT 99-07<br>Scarabeo 125/200 03/07<br>Sport City 125/200 04-07<br>Scarabeo 250 06<br>Sportcity 250 ie 07<br>Atlantic 400 Sprint 07<br>Scarabeo 400 ie 07<br>Atlantic 500 02-05<br>Atlantic 500 Sprint 07<br>Scarabeo 500/500 ABS 03-06<br>Scarabeo 500 Light 06<br>Scarabeo ie 07<br><b>DERBI</b><br>Boulevard S125 07   | 260      |
| MD943D   | FRONT       | S    | <b>APRILIA</b><br>SR 50 (All models) 97-07<br>Rally A/C & L/C 95-02<br>Gulliver (All models) 95-98<br>Habana 50 (All models) 99-02<br>Mojito/Mojito Custom 50 03-07<br>Habana 125 (All models) 00-02<br>SR 125/150 99-02<br>Mojito/Mojito Custom 125 03-07<br><b>GILERA</b><br>Stalker 50 (All models) 97-07<br>Storm 50 94-95<br><b>MBK</b><br>CS 50 Z/CS 50 Mach G 02-06<br>YN 50 R Ovetto 98-06<br>YN 100 Ovetto 99-03<br><b>PIAGGIO</b><br>Diesis 50 01-05<br>NRG 50 94-96<br>NTT 50 95-96<br>NRG 50 RST (DT/DD) MC2 96-98<br>Typhoon 50 94-97<br>Typhoon 50 X 98-99<br>Typhoon 50 XR 00<br>Typhoon 50 01-07<br>Diesis 100 01-03<br>Typhoon 125 95-03<br>Typhoon 125 X-XR 99-00<br><b>P.G.O.</b> T/Rex 125 99-00<br>PMX 50/110 00-02<br><b>YAMAHA</b><br>CS 50 Jog R/Jog RR 02-07<br>YN 50 R Neos 98-07<br>YN 100 "Neos 100" 99-03 | 190      | MD953D   | REAR        | S    | <b>ITALJET</b><br>Jupiter 125/150/250 02-03<br><b>MBK</b><br>YP 250 Skyliner 230 00-02<br><b>YAMAHA</b><br>YP 250 Majesty 00-03   | 230      |
| MD943D   | REAR        | S    | <b>APRILIA</b><br>Area 51 98-01<br>SR 50 (All models) 97-07<br>Rally 50 L/C 96-01<br>Leonardo 125/150 ST/SP 96-04<br>Scarabeo 50 98-04   |          | MD954D   | FRONT       | S    | <b>PEUGEOT</b><br>LOOXOR 50 01-06<br>LOOXOR 100 01-05<br>LOOXOR 125/150 03-06   | 226      |
| MD944D   | FRONT       | S    | <b>GILERA</b><br>DNA 50 01-06<br>DNA 125/180 01-05   | 240      | MD955D   | FRONT       | S    | <b>MALAGUTI</b><br>Ciak 50 00-04<br>Ciak 50 (4T) Master 04-07<br>Ciak 100 99-03<br>Ciak 125/150 01-07<br>Ciak 200 06-07<br><b>BENELLI</b><br>Pepe 50/50 LX 99-07<br><b>GILERA</b><br>Runner 50 PJ/SP 06-07  | 230      |
| MD944D   | REAR        | S    | <b>GILERA</b><br>Runner 125/180 All models 99-04<br>DNA 125/180 01-03  | 240      | MD956D   | FRONT       | S    | <b>PIAGGIO/VESPA</b><br>Liberty 50 2T/50 4T/2T 97-07<br>Liberty S 50 (2T/4T) 07<br>LXV 50 07<br>NRG 50 DD 06-07<br>NRG 50 Purejet 06-07<br>Liberty 125/200 98-06<br>Liberty S 125 07<br>GT 125 L Granturismo 03-06<br>GTV 125 07<br>LXV 125 07<br>GT 200 L Granturismo 03-06<br>Liberty S 200 07<br>GTS 250 iE/ABS 05-07<br>GT 60 (Special Anniversary Model) (GTV 250) 06<br>GTV 250 ie 07<br><b>DERBI</b><br>GP1 50 Open 06-07<br><b>PIAGGIO/VESPA</b><br>Super Hexagon GTX 125/180 (12" wheels) 01-03<br>GT 125 L Granturismo 03-06<br>GTV 125 07<br>GT 200 L Granturismo 03-06<br>GTS 250 iE/ABS 05-07<br>GT 60 (Special Anniversary Model) (GTV 250) 06<br>GTV 250 ie 07<br><b>GILERA</b><br>VX 125 Runner (4T) 05-07<br>VXR 200 Runner (4T) 02-04/05-07 | 220      |
| MD945D   | FRONT       | S    | <b>APRILIA</b><br>Scarabeo 50/100 (2T/4T) 98-07  | 220      | MD956D   | REAR        | S    | <b>PIAGGIO/VESPA</b><br>Super Hexagon GTX 125/180 (12" wheels) 01-03<br>GT 125 L Granturismo 03-06<br>GTV 125 07<br>GT 200 L Granturismo 03-06<br>GTS 250 iE/ABS 05-07<br>GT 60 (Special Anniversary Model) (GTV 250) 06<br>GTV 250 ie 07<br><b>GILERA</b><br>VX 125 Runner (4T) 05-07<br>VXR 200 Runner (4T) 02-04/05-07   | 220      |
| MD946D   | FRONT/ REAR | S    | <b>MALAGUTI</b><br>Phantom F12 (L/C) 96-07<br>F12 50 Phantom 99-03<br>F12 Phantom (Air cooled) 02-07<br>F15 Firefox 01-05<br>Firefox F15 (Air cooled) 99-06<br>CIAK (Electric Power) 00-05   | 200      | MD957D   | FRONT       | S    | <b>MBK</b><br>XQ 125/150 Thunder 01-03<br><b>YAMAHA</b><br>XQ 125/150 Maxster 01-03   | 245      |
| MD947D   | FRONT       | S    | <b>PEUGEOT</b><br>Elystar 50 TDSI/Advantage 02-07<br>Elyseo 100 98-03  | 226      | MD958D   | REAR        | S    | <b>MBK</b><br>XQ 125/150 Thunder 01-03<br><b>YAMAHA</b><br>XQ 125/150 Maxster 01-03   | 220      |
| MD948D   | REAR        | S    | <b>ITALJET</b><br>Dragster 50 LC 98-07<br>Dragster 250 07  | 190      |          |             |      |   |          |
| MD949D   | REAR        | S    | <b>ITALJET</b><br>Dragster 125/180 LC 00-03<br><b>SUZUKI</b><br>AH 80/100 92-94  | 240      |          |             |      |   |          |
| MD950D   | REAR        | S    | <b>ITALJET</b><br>Formula 50/125 LC 96-03  | 175      |          |             |      |   |          |
| MD951D   | FRONT       | S    | <b>ITALJET</b><br>Torpedo 50 All models 98-03<br>Torpedo 125 4T 99-03  | 220      |          |             |      |   |          |

D = Dished Solid Original (We replace with floating rotor conversion unit) F = Floating Rotor S = Solid Rotor  
SF = Solid Flat Original Disc which we replace with fully floating unit - fits direct no mods required.

# STREETBIKE DISC BUYERS GUIDE

| DISC No. | FRONT/ REAR | TYPE | MODELS  | DIA (MM) | DISC No. | FRONT/ REAR | TYPE | MODELS  | DIA (MM) |
|----------|-------------|------|---|----------|----------|-------------|------|---|----------|
| MD959D   | FRONT       | S    | <b>PIAGGIO</b><br>X9 125 00-07<br>X9 125 Evolution 03-05<br>X9 200 02-03<br>X9 200 Evolution 03-04<br>X9 250/250 SL 00-04<br>X9 250 05-06<br>X9 180 Amalfi 00-03  | 240      | MD964D   | FRONT       | S    | <b>DERBI</b><br>Hunter 96-99<br>Predator/Replica LC 98-02<br>Atlantis All models 50/100cc (2T) 99-05<br>Atlantis 50 LC/City/Bullet 02-07<br>Predator Air Cooled 98-01<br>Red Bullet 50 04-05<br>Atlantis Two Chic 06-07<br><b>HUSQVARNA</b><br>WRS 50 Scooter 98-00   | 190      |
|          | REAR        | S    | X9 125 00-07<br>X9 125 Evolution 03-05<br>X9 200 02-03<br>X9 200 Evolution 03-04<br>X9 250/250 SL 00-04<br>X9 250 05-06<br>X9 180 Amalfi 00-03<br><b>DERBI</b><br>GP 125 06-07  |          |          |             |      |   |          |
| MD960D   | FRONT/ REAR | S    | <b>PIAGGIO</b><br>MP3 125 (All models) 06-07<br>X8 125 04-06<br>X8 125 ie/Street 07<br>X8 150 Street 07<br>X8 200 04-05<br>MP3 250 ie (All models) 06-07<br>X8 250 ie 05-07<br>X9 250 04<br>MP3 400 ie (All models) 07<br>X8 400 ie 07<br>X9 500/500 SL 00-02<br>X9 500cc Evolution 03-04<br>X9 500 ie 07<br>Super Hexagon GTX 125/180 (12" wheels) 01-03<br>Beverley B500 02-06<br>Beverley 500 06<br>Beverley Cruiser 500 ie 07<br><b>GILERA</b><br>Nexus 250 ie 07<br>Nexus 125 07<br>Nexus 500 03-07<br>Fuoco 500 IE 07 | 240      | MD965D   | FRONT       | S    | <b>YAMAHA</b><br>CV 50 ZR (5PT1) Evolution 01-02<br>CV 50 (5KN1/2) Jog-Cool Style 00-02<br>CV A/R Jog 03  | 155      |
|          |             |      |   |          |          |             |      |   |          |
| MD961D   | FRONT       | S    | <b>PIAGGIO</b><br>Beverley B125/200 02-06<br>Beverley 125 07<br>Beverley S 125 07<br>X8 125 ie/Street 07<br>X8 150 Street 07<br>Beverley 250 06<br>Beverley 250 ie 07<br>Beverley S 250 ie 07<br>X8 250 ie 07<br>Beverley 400 ie 07<br>X8 400 ie 07<br>X9 500/500 SL 00-02<br>X9 500 ie 07<br>Beverley B500 02-05<br>Beverley 500 06  | 260      | MD966D   | REAR        | S    | <b>BENELLI</b><br>Velvet 125/150/250 99-07<br>250 99-03<br><b>MALAGUTI</b><br>250 S 99-03<br>Phantom Max 125/200 04-07<br>R 125 Madison 03-07<br>Madison S 200 04<br>250 Madison 05-07<br>Phantom Max 250 04-07   | 220      |
|          |             |      |   |          |          |             |      |   |          |
| MD961D   | REAR        | S    | Beverley B125/200 02-05<br>Beverley 125 07<br>Beverley S 125 07<br>Beverley 250 06<br>Beverley 250 ie 07<br>Beverley S 250 ie 07<br>Beverley 400 ie 07<br>Beverley Cruiser 500 ie 07<br><b>GILERA</b><br>Nexus 250 ie 07<br>Nexus 125 07  | 260      | MD968D   | FRONT/ REAR | S    | <b>BMW</b><br>C1 125/200 99-03  | 220      |
|          |             |      |   |          | MD969D   | FRONT       | S    | <b>MALAGUTI</b><br>K 400 Madison 02-06  | 270      |
| MD962D   | REAR        | S    | <b>MBK</b><br>YP 125 D Skyliner 01-06<br><b>YAMAHA</b><br>YP 125 Majesty 01-07  | 190      | MD970D   | FRONT       | S    | <b>HONDA</b><br>NES 125/150 Y/1/2/3/4/5 00-05<br>SH 125 1/3/4/5/6i/7i 01-07<br>SH 150 1/3/4/5/6i/7i 01-07<br>SES 125 2/3/4 Dylan 02-07<br>SES 150 2/3/4 Dylan 02-06   | 220      |
|          |             |      |   |          | MD971D   | FRONT/ REAR | S    | <b>KYMCO</b><br>Agility 50 (KG105A) 05-07<br>Cobra 50 Cross/Racer 00-06<br>Dink 50/Spacer 50/Yager 50 98-07<br>Super 9 50 (L/C) 00-06<br>Top Boy 50 (On road /off road models) 97-05<br>Vitality 50 (2T/4T) 05-07<br>Yager 50 07<br>Yup 50 02-07<br>ZX 50 Super Fever/Scout (SC10AS) 99-06<br>Maxxer 90 05-06<br>Agility 125 06-07<br>Grand Dink 125/150 01-02<br>Dink Classic 125/150 02<br>Dink LX 125/150 98-00<br>Dink 125/150/Spacer 97-04<br>Movie XL 125/150 01-05<br>Yager 125 00<br>People 250 S 06<br>Vitality Cross (10" wheels) 07<br><b>ARCTIC CAT</b><br>DVX 50 (Y6) 06<br>DVX 90 (Y12 4 Stroke) 06 | 180      |
| MD963D   | FRONT       | S    | <b>YAMAHA</b><br>T 105 E (5ER 1/2) Crypton-R 99<br>T 105 SE 02<br>V 110 ZE/ZK/ZHE/ZHK/FIZR/FIZR Sporty  | 220      | MD972D   | FRONT       | S    | <b>KYMCO</b><br>Movie XL 125/150 97-03<br>Vivio 125/150 00-03   | 200      |
|          |             |      |   |          |          |             |      |   |          |

D = Dished Solid Original (We replace with floating rotor conversion unit) F = Floating Rotor S = Solid Rotor  
SF = Solid Flat Original Disc which we replace with fully floating unit - fits direct no mods required.

# STREETBIKE DISC BUYERS GUIDE

| DISC No. | FRONT/ REAR | TYPE | MODELS  | DIA (MM) | DISC No. | FRONT/ REAR | TYPE | MODELS   | DIA (MM) |
|----------|-------------|------|---|----------|----------|-------------|------|--|----------|
| MD973D   | FRONT       | S    | <b>KYMCO</b><br>Bet & Win 50/Dink Sport 50 02-06<br>Bet & Win 125/150 00-06<br>Grand Dink/Miler 125/150 01-07<br>Dink Classic 125/150 02<br>Dink Classic Euro 2 50 03<br>Grand Dink 250 01-06<br>Bet & Win 250 00-06<br>Yup 250 03-06               | 220      | MD991D   | FRONT       | S    | <b>DERBI</b><br>GP-1 (50) 01-05  | 190      |
| MD974D   | REAR        | S    | <b>KYMCO</b><br>Bet & Win 125/150 00-06<br>Grand Dink/Miler 125/150 01-07<br>Yager GT 125 07<br>Grand Dink 250 01-06<br>Bet & Win 250 00-06<br>Yup 250 03-06  | 200      | MD992D   | FRONT       | S    | <b>PEUGEOT</b><br>Ludix Snake/Bullet/Trend 04-07<br>Ludix Acid 06<br>Ludix Red Zone 06<br>Ludix Urban Track 06-07  | 155      |
| MD975D   | REAR        | S    | <b>SUZUKI</b><br>UH 125 K2-K6 Burgman 02-06   | 220      | MD993D   | FRONT       | S    | <b>PEUGEOT</b><br>Ludix Elegance 04-07   | 190      |
| MD976D   | FRONT       | S    | <b>SUZUKI</b><br>UH 125 K2-K6 Burgman 02-06   | 220      | MD994D   | FRONT       | S    | <b>SUZUKI</b><br>AN 400 K3-K7 03-07<br>AN 650 AK4/K4/AK5/K5/AK6/AK7 04-07  | 260      |
| MD977D   | FRONT       | S    | <b>PEUGEOT</b><br>Elyseo 125/150 Rear Disc Model 03   | 226      | MD995D   | FRONT       | S    | <b>YAMAHA</b><br>VP 300 R/S/T Versity 03-05<br>XC 300 V Versity 06   | 270      |
| MD978D   | REAR        | S    | <b>PEUGEOT</b><br>Elyseo 125/150 Rear Disc Model 03<br>Elystar 50 TDSI/Advantage 02-07<br>Elystar 125/150 (All models) 02-07<br>Jet Force 125 (All models) 03-07<br>Satelis 125 4V Executive/<br>Premium/City 06-07<br>Satelis 125 Compressor 06-07 | 210      | MD996D   | REAR        | S    | Atlantic 125/150/250 03-05/07<br>SR 50 Diatech 03-05   | 190      |
| MD979D   | FRONT       | S    | <b>YAMAHA</b><br>YP 125 Majesty DX Taiwan Production 02   | 245      | MD997D   | FRONT       | S    | <b>APRILIA</b><br>Atlantic 125/150/250 03-05/07<br><b>BENELLI</b><br>Velvet 250 99-03  | 240      |
| MD980D   | FRONT       | S    | <b>PEUGEOT</b><br>Elystar 125/150 (All models) 02-07<br>Jet Force 125 (All models) 03-07  | 226      | MD998D   | REAR        | S    | <b>SUZUKI</b><br>AN 650 AK4-AK7 Burgman 04-07  | 250      |
| MD981D   | FRONT       | S    | <b>KYMCO</b><br>Super 9 50 (AC/LC) 00-07  | 210      | MD999D   | FRONT       | S    | <b>ITALJET</b><br>Jupiter 125/150 02<br>Jupiter 250 02-03  | 250      |
| MD982D   | REAR        | S    | <b>ADLY</b><br>125 Thunderbike/Activator  | 165      | MD9100D  | FRONT /REAR | S    | <b>KYMCO</b><br>People 250 (BC 50 AA) 03-06  | 260      |
| MD983D   | FRONT /REAR | S    | <b>GILERA</b><br>Nexus 500 03-07<br><b>PIAGGIO</b><br>X8 125 04-06<br>X8 200 04-05<br>X8 250 ie 05-06<br>X9 250 04<br>X9 500cc Evolution 03-06  | 260      | MD9101D  | FRONT       | S    | <b>BENELLI</b><br>Adiva 125/150 (13" front wheel) 01-04<br>Velvet 125/150 99-07  | 220      |
| MD984D   | REAR        | S    | <b>PEUGEOT</b><br>Jet Force 50 (All models) 03-07   | 190      | MD9102D  | FRONT       | S    | <b>YAMAHA</b><br>YP 125 X-Max 06-07<br>YP 250 V-Max 05-07<br>YP 400 T/V/W Majesty 05-07<br><b>MBK</b> YP 400 Skyliner 04                                     | 267      |
| MD985D   | FRONT       | S    | <b>PEUGEOT</b><br>JetForce 50 (All models) 03-07  | 226      | MD9103D  | REAR        | S    | <b>YAMAHA</b><br>YP 400 S/T Majesty 04<br>YP 400 T/V/W Majesty 05-07   | 267      |
| MD986D   | FRONT       | S    | XC 125 Cygnus X 04-06   | 260      | MD9104D  | REAR        | S    | <b>YAMAHA</b><br>YP 125 RV X-Max 06-07<br>YP 250 RV V-Max 05-07<br><b>MBK</b><br>VP 300 R Kilibre 03-04  | 240      |
| MD987D   | FRONT       | S    | <b>SUZUKI</b><br>AN 650 K3 Burgman 03   | 260      | MD9105C  | FRONT       | S    | <b>PEUGEOT</b><br>Ludix Buster 170 03-05<br>VP 300 R/S/T Versity 06<br>XC 300 V Versity 06   | 170      |
| MD988D   | REAR        | S    | <b>SUZUKI</b><br>AN 650 K3 Burgman 03   | 250      | MD9106D  | REAR        | S    | <b>BENELLI</b><br>Adiva 125/150 01-04  | 220      |
| MD989D   | FRONT       | S    | <b>KYMCO</b><br>People 50/125/200 05-07<br>People S 125/200 (BA40BA) 05-07  | 225      | MD9107D  | FRONT       | S    | CP 250 V (IB71) Maxam/Murphus 05   | 245      |
| MD990D   | REAR        | S    | <b>APRILIA</b><br>Leonardo 125 05-06<br>Leonardo 250 99-04<br>Leonardo 300 05-06<br>Atlantic 500 01-06<br>Scarabeo 500 03-05  | 220      | MD9108D  | REAR        | S    | CP 250 V (IB71) Maxam/Murphus 05   | 245      |
|          |             |      |   |          | MD9109D  | REAR        | S    | AN 400 K7 Burgman 07   | 210      |
|          |             |      |   |          | MD9110D  | FRONT       | S    | Cucciolo 125 00  | 240      |
|          |             |      |   |          | MD9111D  | FRONT       | S    | <b>PEUGEOT</b><br>Satelis 125 4V Executive /Premium/City 06-07<br>Satelis 125 Compressor 06-07<br>Geopolis 250 06-07<br>Satelis 250 06-07<br>Geopolis 400 07 | 260      |

D = Dished Solid Original (We replace with floating rotor conversion unit) F = Floating Rotor S = Solid Rotor  
SF = Solid Flat Original Disc which we replace with fully floating unit - fits direct no mods required.

# STREETBIKE DISC BUYERS GUIDE

















| DISC No.                        | FRONT/ REAR | TYPE | MODELS   | DIA (MM) | DISC No.                        | FRONT/ REAR | TYPE | MODELS   | DIA (MM) |
|---------------------------------|-------------|------|--|----------|---------------------------------|-------------|------|--|----------|
| MD9112D                         | FRONT       | S    | <b>GILERA</b><br>VX 125 Runner (4T) 05-07<br>VXR 200 Runner (4T) 05-07<br>Fuoco 500 ie 07<br><b>PIAGGIO</b><br>MP3 125 (All models) 06-07<br>MP3 250 ie (All models) 06-07<br>MP3 400 ie (All models) 07   | 240      | MD1004<br>MD1004C               | REAR        | S    | FES 125/150 3/4/5/6/7 Pantheon 03-07<br>CBR 250 RRL/RRN/RRR 90-94<br>CB 250 FT/FV/FX/FY/F1 'Hornet' 96-01<br>FES 250 Y/1/2/5 00-05<br>NSS 250 Y/AY/1/A1/A3/3 Forza<br>/Forza-S/Forza-T/Forza-ST/Jazz<br>/Reflex (MF04/MF06) 00-04<br>VTR 250 W/Y/1-7 (MC33) 98-07<br>CBR 400 RRL/RRN/RRR (NC29) Gull-Arm 90-94<br>CB 600 'Hornet' FW/FX/FY /F2Y/F1/F2Y/F2/F3/F4/F5/F6 98-06<br>CBR 600 FM/FN/FP/FR//FS/FT/FV/FW /FX/FY/F1/FS1/F2/FS2/F3/RR3/F3 /F4/RR4/F5/F6/F7 91-07<br>CBR 600 RR5/RR6/RR7 05-07<br>CBR 900 RRN/RRP/RRR/RRS /RRT/RRV/RRW/RRX/RRY /RR1/RR2/RR3 92-03<br>CBR 1000 RR4/RR5/RR6 Fireblade 04-05<br>CBR 1000 RR6/RR7 06-07<br>VTR 1000 SPY/SP1 00-01<br>VTR 1000 SP2/SP3/SP4/SP5/SP6 02-07<br>VTR 1000 FV/FW/FX/FY/F1 /F2/F3/F4/F5/F6 Firestorm 97-06<br><b>PEUGEOT</b><br>SV 250 01-02 | 220      |
| MD9113D                         | FRONT       | S    | <b>DERBI</b><br>GP 125 06-07<br>DPI 250 i 07   | 245      |                                 |             |      |  |          |
| MD9114D                         | FRONT       | S    | <b>ITALJET</b><br>Millenium M100/125/150 LC 00-04  | 218      |                                 |             |      |  |          |
| MD9115D                         | FRONT       | S    | <b>TGB</b><br>Delivery (151cc) 04-07<br>R9 125 cc 06-07<br>303 R Hawk/Laser 125/150 04-07  | 220      |                                 |             |      |  |          |
| MD9116D                         | FRONT       | S    | <b>SYM</b><br>Jet Basix 50 06-07<br>Jet 50/Euro X S 99-05<br>Jet Euro X 50/100 06-07<br>Jungle 50/100 99-02<br>Mask 50 00-05<br>Red Devil 50 99-05<br>Jet 100 G100P-6) 99-00   | 190      |                                 |             |      |  |          |
| MD1001LS<br>MD1001RS            | FRONT       | S    | CBR 400 RG/RH-YA (NC23) 86-87<br>VFR 400 RH2/RJ (NC24) 87-88<br>XBR 500 F/G/H/SJ 85-89<br>CBR 600 FH/FJ/FK/FL FM/FN/FP/FR 87-94<br>CBX 750 FE 84<br>CBR 750 FH Superaero 87<br>VF 750 S Sabre 82-83<br>VF 750 SC 82<br>VFR 750 FG/FH 86-87<br>CBR 400 RG/RH-YA (NC23) 86-87<br>PC 800 Pacific Coast 89-97<br>VF 1000 FE/FF/F2F/FG /F2G 84-86                                   | 276      | MD1005LS<br>MD1005RS            | FRONT       | S    | CB 350 SG/SJ 86-90<br>CB 450 SG/SJ 86-88   | 256      |
| MD1001                          | REAR        | S    | NT 650 VW/VX/VY/V1-V5 'Deauville' 98-05<br>CBR 1000 FH/FJ 87-88<br>CB 1300 DCV 97-   | 276      | MD1006LS<br>MD1006RS<br>MD1006C | FRONT       | S    | CBR 250 FG/FGYA/RH 86-87<br>NS 250 FE (MCII) 84<br>NS 250 RE/RG (MCII) 84-86<br>FJS 400 2 (NF01) Silverwing 01-02<br>FJS 400 D6 Silverwing 06<br>NS 400 RF/RG 85-87<br>VFR 400 ZG/ZH/RG/ RG-YA (NC21) 85-87<br>VF 500 FE/F2E/FF/F2F 84-85<br>FJS 600 1/2/A3/D3/A4/D4/A5/D5 /A6/D6/A7 01-07   | 256      |
| MD1002                          | REAR        | S    | NSR 250 RG (MC16) 86<br>NSR 250 R2J (MC18) 88<br>NSR 250 RSP/RSK/RSP (MC18)<br>NSR 250 RL/RN/RSP (MC21) 95-<br>NS 250 FE (MCII) 84<br>NS 250 RE/RG (MCII) 84-86<br>VT 250 FL Spada/Castec 88-90<br>CBR 400 RG/RGYA (NC23) 86<br>CBR 400 RRJ/RRK (NC23 Tri arm) 92-93<br>NS 400 RF/RG 85-87<br>VFR 400 ZG/ZH/RG/ RH-YA (NC21) 85-87<br>CBR 600 FH/FJ/FK/FL 87-90                | 220      | MD1006<br>MD1006C               | REAR        | S    | VF 500 FE/F2E/FF/F2F 84-85<br>CBR 750 FH/FJ Superaero 87-88<br>VFR 750 FG/FH/FJ/FK 86-89<br>CBR 1000 FP/FR/FS/FT/FV/FW/FX XL 1000 VA4/VA5/VA6 /VA7 Varadero 04-07<br>XL 1000 V3/V4/V5/V6 03-06<br>CB 1100 SFY/SF1 "XII" 00-03<br>CBR 1100 XXV/XXW/XXX/XXY/XX1/XX2 /XX3/XX4/XX5/XX6/XX7 Blackbird 97-07<br>CB 1300 F3/F13 03-04   | 256      |
| MD1003LD<br>MD1003RD            | FRONT       | F    | <b>HONDA</b><br>RS 125 90-<br>RS 250 90-   | 296      | MD1007                          | REAR        | S    | VFR 750 FL/FM/FN/FP FR/FS/FT/FV 94-97  | 256      |
| MD1003LS<br>MD1003RS<br>MD1003C | FRONT       | F    | CBR 400 RG-YA (NC23) 86<br>CBR 400 RRJ/RRK (NC23) Tri-Arm 81-89<br>CBR 400 RRL/RRN/RRR (NC30) Gull-Arm 90-94<br>RVF 400 RR/RR-II/RT/RT-II (NC35) 94-96<br>VFR 400 R3K/R3N (NC30) 89/92<br>VFR 400 R3L/R3M (NC30) 90-91<br>CBR 600 FS/FT/FV/FW 95-98<br>VFR 750 FR/FS/FT/FV/ 94-97<br>CBR 900 RRR/RRS/RRT/ RRV 94-97<br>VTR 1000 FV/FW/FX/FY /F1/F2/F3/F4/F5/F6 Firestorm 97-06 | 296      | MD1008LS<br>MD1008RS            | FRONT       | S    | NV 400 DCY/DC1/DC2 (NC40) Shadow Slasher 00-02<br>CB 500 R/T/V/W/SW/X/SY/SY2/S2 94-02<br>NT 650 VW/VX/VY/V1 Deauville 98-01<br>NT 650 V2-V5 Deauville 02-05<br>NT 700 V6/V7 Deauville 06-07<br>CB 750 F2N/F2R/F2S/F2T/F2V /F2W/F2X/F2Y/F21 CB 'Seven Fifty' 92-02<br>VFR 750 FJ/FK/FL/FM/ FN/FP 88-93<br>VT 750 CV/C2V/CW/C2W/CX/C2X/CY/C2Y /C1/C2/C4/C5/C6/C7 Shadow 97-07<br>VT 750 DC1/DC2 'Black Widow' 01-04<br>VT 750 DCA7 Shadow Spirit 07<br>CBR 1000 FH/FJ/FK/FL/FM/FN /FP/FR/FS/FT/FV/FW/FX 87-99<br>ST 1100 AT/AV/AW/AX 96-99<br><b>CAGIVA</b><br>Navigator 1000 00-05<br>Canyon 500 96-00<br>Canyon 600 96-99  | 296      |

DISC BUYERS GUIDE

























D = Dished Solid Original (We replace with floating rotor conversion unit) F = Floating Rotor S = Solid Rotor  
SF = Solid Flat Original Disc which we replace with fully floating unit - fits direct no mods required.

# STREETBIKE DISC BUYERS GUIDE

| DISC No.   | FRONT/ REAR | TYPE | MODELS   | DIA (MM)   | DISC No. | FRONT/ REAR  | TYPE  | MODELS                | DIA (MM)  |   |     |
|--|-------------|------|--|--|----------|--|-------|-----------------------|---|---|-----|
|  MD1010LS/RS            | FRONT       | F    | VFR 750 RJ/RK/RL (RC30)  | 88-90  | 310      |  |       | <b>NOT BEING MADE</b> |   |   |     |
| MD1011   | REAR        | S    | VFR 750 RJ/RK/RL (RC30)  | 88-90  | 220      |  MD1038 RS              | FRONT | F                     | CB-1 (CB 400 F)   | 89-90   | 310 |
|  MD1012LS/RS            | FRONT       | F    | RVF 750 RR/RS (RC45)   | 94-98  | 310      |  MD1040LS/RS            | FRONT | S                     | GL 650 D2E  | 84  | 276 |
| MD1013   | REAR        | S    | RVF 750 RR/RS (RC45)   | 94-98  | 220      | MD1041LS   | FRONT | S                     | CMX 450 CH/CJ Rebel   | 87-88   | 276 |
|  MD1014LS               | FRONT       | F    | CBR 600 FX/FY<br>VFR 800 FiW/FiX<br>VFR 800 FiY/Fi1/2/3/4/5<br>CBR 900 RRN/RRP<br>XL 1000 VX/VY/V1/V2/V3/V4/V5/V6<br>XL 1000 VA4-VA7<br>GL 1500 CV/CW/CX/CY<br>/C1/C2 (F6C)<br>GL 1800 A1-A7   | 99-00<br>98-99<br>00-05<br>92-93<br>99-06<br>04-07<br>97-03<br>01-07   | 296      | MD1045LS   |       |                       | <b>NOT BEING MADE</b>   |   |     |
| MD1016   | REAR        | S    | NT 700 V6/V7 Deauville<br>CB 1000 FP/FR/FS/FT/FV<br>CBR 1000 FK/FL/FM/FN<br>VT 1100 C4 Shadow Sabre  | 06-07<br>93-97<br>89-92<br>04-05   | 276      |  MD1046                 |       |                       | <b>USE MD1082</b>   |   |     |
| MD1020   | REAR        | S    | NSS 250 EX5/EX6 (ABS) Forza EX<br>NSS 250 AX5/AX6 (Forza Z) (ABS)<br>CB-1 (CB 400 F)<br>CB 400 SF (F2N/F2R<br>/F2V/F3T/F3V) Superfour<br>CB 500 VW/SW/X/SX/Y/SY/2/S2<br>CB 750 F2N/F2R/F2S/F2T/F2V<br>/F2W/F2X/F2Y/F21<br>'CB Seven Fifty'<br>CB 900 F2/F3/F4/F5/F6/F7   | 05-06<br>05-06<br>89-90<br>92-97<br>97-03<br>92-02<br>02-07  | 240      | MD1047LS   | FRONT | S                     | NV 400 CJ/CK Steed<br>NV 400 CS/CV Steed<br>FT 500 C<br>VT 600 CN/CR/CS/CT/CV/CW/CX<br>'Shadow custom'<br>VF 750 C Shadow   | 92-93<br>95-97<br>82<br>93-00<br>83                               | 296 |
|  MD1021LS<br>MD1021RS | FRONT       | SF   | VT 250 CR/CT/CV 'Magna'<br>NTV 600 J/K/M Revere<br>NTV 650 J/K/L/M/P/S/T/V<br>VF 750 CP/CR/CS/CT/CV<br>ST 1100 L/M/N/P/R/S/T/V/W/X<br>/AN/AP/AR/AS<br>VT 1100 C3 Shadow<br>VT 1100 C4 Shadow Sabre   | 95-97<br>88-92<br>88-97<br>93-97<br>90-99<br>04-05   | 316      |  MD1048                 | REAR  | F                     | FT 500 C  | 82  | 276 |
| MD1022   | REAR        | S    | VFR 400 RH2/RJ (NC24)<br>NT 400 'Bros' NC25<br>NT 650 J/K/L (Bros) (NC31)  | 87-88<br>88-92   | 240      | MD1051LS   |       |                       | <b>USE MD1047LS</b>   |   |     |
| MD1024LS/RS  |             |      | <b>USE MD1001LS/RS</b>   |  |          |  MD1056LS/RS            | FRONT | F                     | CB 1000 FP/FR/FS/FT/FV  | 93-97   | 310 |
| MD1025   | REAR        | S    | NTV 600 J/K/M Revere<br>NTV 650 J/K/L/M/P/S/T/V  | 89-92<br>88-97   | 276      | MD1059LS   | FRONT | S                     | VF 750 CH   | 87  | 316 |
| MD1026RS   |             |      | <b>NOT BEING MADE</b>  |  |          |  MD1062LS              | FRONT | D                     | CB 750 F/F1<br>CB 750 K6/K7   | 75-76<br>77-78  | 296 |
|  MD1030LS<br>MD1030RS | FRONT       | S    | CA 125 S/T/V/W/X Rebel<br>VT 125 CX/CY/C2Y/C1/C21/C3/C4/C7<br>'Shadow'<br>CBX 250<br>CMX 250 CT/CV/CW 'Rebel'  | 95-00<br>99-07<br>84-98<br>96-00   | 240      |  MD1064               | REAR  | F                     | CB 750 F/F1/F2<br>GL 1000 2 Goldwing<br>GL 1000 K/K1/K2/K3 Goldwing   | 76-78<br>79<br>75-  | 296 |
| MD1035LS/RS  |             |      | <b>NOT BEING MADE</b>  |  | MD1065   |  |       | <b>USE MD1071</b>     |   |   |     |
|  MD1036LS<br>MD1036RS | FRONT       | D    | CB 250 N/NA/NB/NDB/NDC<br>CM 250 TB<br>CX 500 EC<br>CB 650 SCC Nighthawk<br>CX 650 ED<br>CB 750 KZ<br>CB 750 FZ/FA/FB/FC/F2C/FD/F2D<br>CB 900 FZ/FA/FB/F2B<br>CB 900 FC/F2C/FD/F2D<br>CBX 1000 Z<br>GL 1000 K3/KZ Goldwing<br>GL 1000 Z<br>GL 1100 A/DA/B/DB<br>Goldwing<br>GL 1100 1A/1B Interstate<br>Goldwing<br>GL 1100 C/DC | 78-82<br>81<br>82<br>82<br>83<br>80<br>78-84<br>80-83<br>84-85<br>79-80<br>77-78<br>79<br>80-81<br>80-81<br>82 | 276      | MD1068   | REAR  | S                     | VF 750 FD/FE  | 83-84   | 296 |
|  |             |      |  |  |          |  MD1071               | REAR  | D                     | CB 750 FZ/FA/FB<br>CB 900 FZ/FA<br>CBX 1000 Z<br>CBX 1000 B/C<br>GL 1000 K/K1-K3/KZ<br>GL 1100 A/DA/B/DB Goldwing<br>GL 1100 1A/1B Interstate Goldwing<br>GL 1100 C/DC                          | 78-82<br>80-81<br>79-80<br>81-82<br>75-79<br>80-81<br>80-81<br>82 | 296 |
|  |             |      |  |  |          | MD1074LS/RS  | FRONT | D                     | GL 1000 K/K1/K2   | 75-77   | 276 |
|  |             |      |  |  |          |  MD1076LS<br>MD1076RS | FRONT | D                     | <b>USE MD1036LS/RS</b>  |   | 276 |
|  |             |      |  |  |          | MD1077   | REAR  | S                     | ST 1100 L/M/N/P/R/S/T/V<br>/W/X/Y/1<br>ST 1100 AN/AP/AR/AS<br>GL 1500 L/SEM/SEN/SEP/<br>SER/SES/SEV/SEW/SEX/SEY<br>Goldwing<br>GL 1500 CV/CW/CX   | 90-01<br>92-95<br>88-00<br>97-99                                  | 316 |
|  |             |      |  |  |          | MD1079   | REAR  | S                     | CBX 750 FE<br>VF 1000 FE/FF/F2F/FG/F2G  | 84<br>84-86   | 276 |
|  |             |      |  |  |          | MD1080   | FRONT | F                     | VT 1100 CH/CJ/CN/CP Shadow<br>VT 1100 CR/CS/CT/CV/CW Shadow   | 87-93<br>94-98  | 336 |
|  |             |      |  |  |          |  MD1082               | REAR  | D                     | CB 750 FC/F2C/FD/F2D<br>CB 900 FB/F2B/FC/F2C/FD/F2D<br>CBX 1000 B/C<br>GL 1100 AD<br>GL 1100 C/DC/1C Interstate<br>Goldwing<br>GL 1100 AC/AD Aspencade<br>Goldwing<br>GL 1200 DE/DF/DG/AE/AF/AG | 83-84<br>84-85<br>80-82<br>83<br>82<br>82-83<br>84-86             | 296 |

D = Dished Solid Original (We replace with floating rotor conversion unit) F = Floating Rotor S = Solid Rotor  
SF = Solid Flat Original Disc which we replace with fully floating unit - fits direct no mods required.













# STREETBIKE DISC BUYERS GUIDE

| DISC No.   | FRONT/ REAR | TYPE | MODELS   | DIA (MM)              | DISC No. | FRONT/ REAR   | TYPE  | MODELS | DIA (MM)   |  |     |
|--|-------------|------|--|-----------------------|----------|---|---|--------|--|--|-----|
| MD1083LS/RS<br>   | FRONT       | D    | VF 750 FD/FE<br>GL 1200 DE/DF/DG   | 83-84<br>84-86        | 276      | MD1126LS<br>MD1126RS  | FRONT   | S      | GL 1500 J/K/L/SEM/SEN/SEP/<br>SER/SES/SEV/SEW/SEX/SEY<br>Goldwing  | 88-00  | 296 |
| MD1084LS   | FRONT       | S    | NS 125 FG/FH/RH  | 86-90                 | 240      | MD1127  | REAR  | S      | GL 1500 J/K Goldwing   | 88-89  | 296 |
| MD1088LS<br>      | FRONT       | F    | NSR 125 FM/RK/RL/<br>RM/RN   | 91-92                 | 316      | MD1129LS/RS<br>              | FRONT   | F      | NSR 250 RG (MC16)  | 86   | 256 |
| MD1089LS<br>      | FRONT       | S    | CB 250 N/T/W/X/Y/1/4 (CB Two Fifty)  | 92-05                 | 240      | MD1130  |   |        | NOT BEING MADE   |  |     |
| MD1090LS   | FRONT       | S    | CBX 250 RSE<br>CD 250 UJ   | 84<br>88-92           | 240      | MD1131LS<br>                 | FRONT   | F      | FT 500 C   | 82   | 296 |
| MD1092LS<br>MD1092RS   |             |      | USE MD1003LS/RS  |                       |          | MD1132LS<br>MD1132RS<br>MD1132C   | FRONT   | F      | CB 400 SF (F2N/F2R/F2V/F3T/F3V)<br>Superfour<br>CB 600 FW/FX   | 92-<br>98-99                                 | 296 |
| MD1093LS<br>MD1093RS   |             |      | USE MD1003LS/RS  |                       |          |                              |   |        | 16" wheel  |  |     |
| MD1095LS<br>MD1095RS   |             |      | USE MD1083LS/RS  |                       |          | MD1133LS/RS<br>              | FRONT   | F      | GL 1100 AD<br>GL 1100 AC Aspencade<br>Goldwing   | 83<br>82                                     | 296 |
| MD1100LS<br>MD1100RS   |             |      | USE MD1133LS/RS  |                       |          | MD1134LS<br>MD1134RS<br>MD1134C   | FRONT<br> | F      | CBR 900 RRW/RRX  | 98-99  | 310 |
| MD1101   | FRONT       | S    | KYMCO<br>Venox 250   | 00-06                 | 316      | MD1135  | REAR  | S      | ST 1100 AT/AV/AW/AX/AY/A1<br>'Pan European'  | 96-01  | 296 |
| MD1102   |             |      | USE MD1077   |                       |          | MD1136LS/RS<br>MD1136C<br> | FRONT   | F      | CBR 1100 XXX/XXY/XX1-XX7 Blackbird<br>CB 1100 SFY/SF1 "XII"  | 99-07<br>00-03                               | 310 |
| MD1103LS   |             |      | USE MD1047LS   |                       |          | MD1137LS<br>MD1137RS<br>   | FRONT   | F      | CBR 900 RRY/RR1 "929cc Fireblade"<br>CBR 900 RR2/RR3 954cc   | 00-01<br>02-03                               | 330 |
| MD1108   |             |      | N/A  |                       |          | MD1137C<br>                |   |        |  |  |     |
| MD1109LS<br>    | FRONT       | F    | NSR 125 FP/FP/RR/<br>RV/RW/RX/R1   | 93-04                 | 316      | MD1138LS<br>MD1138RS<br>   | FRONT   | F      | VTR 1000 SPY/SP1 (SC45)<br>VTR 1000 SP2/SP3/SP4/SP5/SP6  | 00-01<br>02-07                               | 320 |
| MD1110   |             |      | N/A  |                       |          | MD1138C<br>                |   |        |  |  |     |
| MD1111   | REAR        | S    | NSR 250 RR/R2R (MC28)<br>VFR 400 RK3/R3L/R3M<br>/R3N (NC30)<br>RVF 400 RR/RR-II/RT/RT-II<br>(NC35) | 94-<br>89-92<br>94-96 | 220      | MD1139LS/RS<br>MD1139C  | FRONT   | F      | CB 600 FY/F2Y/F1/F21/F22/F2/F3<br>/F4/F5/F6  | 00-06  | 296 |
| MD1112LS<br>MD1112RS   |             |      | NOT BEING MADE   |                       |          | MD1140RS<br>               | FRONT   | F      | CBR 250 RJ/RK/R2K MC19   | 88-89  | 310 |
| MD1113   |             |      | NOT BEING MADE   |                       |          | MD1141LS/RS<br>MD1141C<br> | FRONT   | F      | CBR 600 F1/F2/F3/F4/F5/F6/F7<br>CBR 600 FS1/FS2 'Sport'<br>CB 600 F7 Hornet<br>CB 600 AF7 Hornet (ABS)<br>CB 900 F2-F7 Hornet<br>VTX 1800 C2/C3/C4/C15 | 01-07<br>01-02<br>07<br>07<br>02-07<br>02-05 | 296 |
| MD1114LS   |             |      | USE MD1001LS   |                       |          | MD1142RS  | FRONT   | S      | NSR 75 N/P/R/X/Y<br>(NS-1/NSR80)   | 92-00  | 256 |
| MD1115LS<br>MD1115RS   | FRONT       | D    | CX 650 TD Turbo  | 83                    | TBA      | MD1143  | REAR  | S      | NSR 75 N/P/R/X/Y<br>(NS-1/NSR80)   | 92-00  | 220 |
| MD1116<br>      | REAR        | D    | CB 1100 RB11/RC11/RD11   | 80-83                 | 296      | MD1144RS<br>               | FRONT   | F      | CB 250 FT/FV/FX/FY/F1 Hornet<br>VTR 250 W/Y/1-7 (MC33)   | 96-01<br>98-07                               | 296 |
| MD1117LS/RS<br> | FRONT       | F    | NSR 250 RL/RN/RSP (MC21)<br>NSR 250 RG (MC16)<br>NSR 250 R2J/RSP/RSK/RSP (MC18)                    | 95-<br>86             | 276      |   |   |        |  |  |     |
| MD1118   |             |      | USE MD1077   |                       |          |   |   |        |  |  |     |
| MD1120LS/RS<br> | FRONT       | F    | CBR 1100 XXV/XXW Blackbird   | 97-98                 | 310      |   |   |        |  |  |     |
| MD1124LS<br>    | FRONT       | F    | NT 400 BROS NC25<br>NT 650 J/K/L (Bros) (NC31)   | 88-92                 | 320      |   |   |        |  |  |     |
| MD1125LS/RS<br> | FRONT       | D    | GL 1200 AE/AF/AG<br>Goldwing   | 84-86                 | 276      |   |   |        |  |  |     |

D = Dished Solid Original (We replace with floating rotor conversion unit) F = Floating Rotor S = Solid Rotor  
SF = Solid Flat Original Disc which we replace with fully floating unit - fits direct no mods required.







# STREETBIKE DISC BUYERS GUIDE

| DISC No.   | FRONT/ REAR | TYPE | MODELS   | DIA (MM)                | DISC No. | FRONT/ REAR   | TYPE  | MODELS | DIA (MM)   |       |     |
|--|-------------|------|--|-------------------------|----------|---|-------|--------|--|-------|-----|
| MD1145LS/RS<br>                       | FRONT       | F    | CBR 250 RRL/RRN/RRR (MC22)   | 90-94                   | 276      | MD1164  | REAR  | S      | VFR 800 FiY/Fi1/2/3/4/5 00-05<br>VFR 800 A2/A3/A4/A5 (ABS) 02-05<br>VFR 800 6/7 06-07<br>VFR 800 A6/A7 (ABS) 06-07   | 256   |     |
| MD1146LS<br>MD1146RS   | FRONT       | S    | VF 1000 RE/RF/RG   | 84-86                   | 276      | MD1165  | REAR  | S      | VFR 800 FIW/FIX  | 98-99 | 256 |
| MD1147LS   | FRONT       | S    | CLR 125 W 'City Fly'<br>NX 125 K/S/T<br>CRM 125 RL/RM/R/RR/RRV/RX  | 99-03<br>89-97<br>90-99 | 240      | MD2001LS<br>MD2001RS<br> | FRONT | F      | TZR 250 (3MAI) 89<br>FZR 400 RR (4DX) 92<br>FZ 400 96<br>FZR 400 (3TJ1/2/6/7)<br>FZR 400 (3ENZ) 89<br>XJR 400 4HM1/4HM2/4HM4/4HM7 93-96<br>XJR 400 4HM3/4HM5/4HM6/4HM9<br>/4HMA/4HMB 95-99<br>FZR 600 89-93<br>FZR 600 R 94-95<br>FZS 600 Fazer 98-03<br>FZ 750 89-91<br>TDM 850 91-01<br>TRX 850 96-99<br>FJ 1200 (3CV/3XW Type) 88-95  | 298   |     |
| MD1148   | REAR        | S    | GL 1500 CY/C1/C2 (F6C)<br>VTX 1800 C2/C3/C4/C15  | 00-03<br>02-05          | 316      | MD2001C<br>              |       |        | APRILIA<br>RST Futura 1000 01-04<br>DUCATI<br>900 Supersport 89-90<br>907 IE 90-91   |       |     |
| MD1149   | REAR        | S    | FJS 400 2 (NF01) Silverwing 01-02<br>FJS 400 D6 Silverwing 06<br>FJS 600 1/2/A3/D3/A4/D4/A5/D5<br>/A6/D6/A7 01-07  |                         | 240      | MD2002<br>MD2002C   | REAR  | S      | FZ 400 96<br>FZ 400 N (1FK/33M/46X) 85<br>SRX 400 (1JL/3VN1/3VN2/3VN5) 85/90-96<br>XJR 400 4HM1/4HM2/4HM4/4HM7 93-96<br>XJR 400 4HM3/4HM5/4HM6/4HM9<br>/4HMA/4HMB 95-99<br>FZ 600 87-88<br>FZR 600 89-93<br>FZR 600 R 94-95<br>FZS 600 'Fazer' 98-03<br>SRX 600 (1JK)/3SX) -85/90-91<br>SRX 600 86-87<br>XJ 600 N 95-03<br>XJ 600 S Diversion 92-03<br>YZF 600 R Thundercat 96-03<br>YZF 750 R/SP 93-97<br>TDM 850 91-01<br>TRX 850 96-99<br>TDM 900 R/R/S/T/V 02-06<br>TDM 900 AT/AV/AW (ABS) 05-07<br>YZF 1000 R Thunderace 96-02<br>DUCATI<br>Supersport 400 93-97<br>400 Monster/Dark 95-97/00-04<br>600 Monster 93-01<br>600 Monster Dark 98-99<br>600 Monster City/City Dark 99<br>600 Supersport 91-97<br>620 IE/SIE Monster 02-04<br>Monster 620 Dark 03-04<br>Monster 620 Catwoman 05<br>Multistrada 620 Dark 05<br>Multistrada 620 05-06<br>Monster 620 05-06<br>Monster Dark 620 05-06<br>750 Supersport 91-99<br>750 Supersport IE 00-02<br>750 Sport 01-02<br>750 Monster 96-98<br>750 Monster City/City Dark 99<br>750 Monster/Monster Dark 99<br>750 Monster 00-01<br>Monster 800 IE/SIE 03-04<br>800 Supersport 03-04<br>851 Superbike Biposto 89-92<br>888 SP4/SP5 92-93<br>888 Superbike Strada 94-95<br>900 Supersport 89-90<br>900 Supersport/Superlight 91-97<br>900 Supersport 98-99<br>900 Supersport CR USA 98<br>900 Supersport FE 98<br>900 Supersport IE 00-01<br>900 Sport 02<br>900 Monster 93-99<br>900 Monster Cromo/Special 98 | 245   |     |
| MD1150RS   | FRONT       | S    | XL 125 V1-V7 Varadero  | 01-07                   | 276      |   |       |        |  |       |     |
| MD1151   | REAR        | S    | XL 125 V1-V7 Varadero 01-07<br>CBR 125 R4/R5/RS5/RW5/RS6/R7 04-07<br>CBR 150 R 00-03   |                         | 220      |   |       |        |  |       |     |
| MD1152LS<br>MD1152RS<br>              | FRONT       | F    | CBR 600 RR3/RR4/RR5/RR6/RR7 03-07<br>CB 1300 5/6 (Superfour) 05-06<br>CB 1300 A5/A6/A7 (Superfour ABS) 05-07<br>CB 1300 SA5/SA6/SA7 Super<br>Bol-Dor 05-07   |                         | 310      |   |       |        |  |       |     |
| MD1152C<br>                           |             |      |  |                         |          |   |       |        |  |       |     |
| MD1153LS<br>MD1153RS<br>            | FRONT       | F    | CBR 1000 RR4/RR5   | 04-05                   | 310      |   |       |        |  |       |     |
| MD1153C<br>                         |             |      |  |                         |          |   |       |        |  |       |     |
| MD1154LS/RS<br>MD1154C<br>          | FRONT       | F    | ST 1300 2/A2/3/A3/4/A4/5/A5/6/A6/A702-07   |                         | 310      |   |       |        |  |       |     |
| MD1155RS   | FRONT       | S    | CBF 500 4 (Non ABS Model) 04<br>CBF 500 A4/A5/A6/A7 ABS Model 04-07  |                         | 296      |   |       |        |  |       |     |
| MD1156   | REAR        | S    | CBF 500 4 (Non ABS Model) 04-05<br>CBF 500 A4/A5/A6/A7 ABS Model 04-07<br>CB 600 F7 Hornet 07<br>CB 600 AF7 Hornet (ABS) 07<br>CBF 600 NA4/NA5/NA6 (ABS) 04-06<br>CBF 600 S4/S5 (NON ABS) 04-05<br>CBF 600 SA4/SA5/SA6 (ABS) 04-06<br>CBF 1000 F6/FA6 06 |                         | 240      |   |       |        |  |       |     |
| MD1157LS<br>MD1157RS<br>MD1157C<br> | FRONT       | F    | VFR 800 A2/A3/A4/A5 (ABS) 02-05<br>VFR 800 6/7 06-07<br>VFR 800 A6/A7 (ABS) 06-07  |                         | 296      |   |       |        |  |       |     |
| MD1158RS   | FRONT       | S    | VTX 1300 S3/S4/S5/S6/S7  | 03-07                   | 336      |   |       |        |  |       |     |
| MD1159   | REAR        | S    | VTX 1300 S3/S4/S5/S6/S7  | 03-07                   | 296      |   |       |        |  |       |     |
| MD1160LS/RS<br>                     | FRONT       | F    | CBR 1000 F6/FA6  | 06                      | 296      |   |       |        |  |       |     |
| MD1161LS/RS<br>                     | FRONT       | F    | CBR 1000 RR6/RR7   | 06-07                   | 320      |   |       |        |  |       |     |
| MD1162LS/RS<br>                     | FRONT       | F    | CBR 750 FJ   | 88                      | 296      |   |       |        |  |       |     |
| MD1163   | REAR        | S    | ST 1300 2/A2/3/A3/4/A4/5/A5/6/A6/A7 02-07  |                         | 316      |   |       |        |  |       |     |

D = Dished Solid Original (We replace with floating rotor conversion unit) F = Floating Rotor S = Solid Rotor  
SF = Solid Flat Original Disc which we replace with fully floating unit - fits direct no mods required.

# STREETBIKE DISC BUYERS GUIDE

| DISC No.   | FRONT/ REAR | TYPE | MODELS   | DIA (MM)  | DISC No.             | FRONT/ REAR   | TYPE  | MODELS                 | DIA (MM)                 |     |
|--|-------------|------|--|---|----------------------|---|-------|------------------------|--------------------------|-----|
| MD2002<br>MD2002C<br>Contd.  | REAR        | S    | <b>DUCATI</b>  | 245   | MD2011LS<br>MD2011RS | FRONT   | S     | RZ 250 R (1AR/1XG/2GL) | 267                      |     |
|  |             |      | 900 Monster City/City Dark 99<br>900 IE Monster 00-01<br>907 IE 90-93<br>Sport Touring ST4-916cc 99-02<br>Monster S4 01-02<br>Sport Touring ST2-944cc 97-02<br>Classic Sport Biposto (992cc) 07<br>STS 3 (992cc) 04-06<br>Sport Touring ST4S/STS ABS 996cc 03-05<br>ST3S (ABS) 06-07<br>GT 1000 Sport (992cc) 06-07<br>1000 DS Supersport 03-06<br>Monster 1000 S4R (996cc) 04-06<br>Paul Smart 1000 Limited 06<br>Sport 1000 (992cc)/1000 S 06-07<br><b>LAVERDA</b> 650 All models 94-95<br>668/750 All models 97-01<br>TTS 800 99-01<br><b>VOXAN</b><br>Black Magic 04-05<br>Street Scrambler 03-05<br>VB1-Evo 03-04<br>Cafe Racer 1000 02-06<br>Roadster 1000 02-06   | RZ 250 RR (5K)<br>RD 350 YPVS 83-84<br>RD 350 F/F2 85-92<br>R 350 N 85<br>RD 350 R 92-95<br>FZ 400 N (IFK/33M/46X) 85-<br>SRX 400 (1J6) 85<br>XS 400 82<br>XZ 550 82-84<br>FZ 600 87-88<br>SRX 600 (1JK) 85<br>SRX 600 86-87<br>XJ 600 84-91<br>XX 600 S/SC/T/TC/U/UC/W<br>'WCA/AAC 'Radian' 86-90<br>XJ 650 Turbo 82<br>XJ 650 LX 'Seca' 83<br>FZX 700 S/SC/T/TC 'Fazer' 86-87<br>FZ 750 87-88<br>FZX 750 87<br>XV 750 Virago 92-93<br>XJ 900 F 87-92<br>XV 1000 Virago 86<br>XV 1000 SE Virago 88<br>XV 1100 Virago 89-93 |                      |   |       |                        |                          |     |
| MD2003LS<br>MD2003RS<br>MD2003C<br> | FRONT       | F    | FZR 250 87-<br>TDR 250 88-92<br>TZR 250 (2MA/2XW) 87-92<br>TZR 250 87<br>SRX 400 (3VN1/3VN2/3VN5) 90-96<br>SRX 600 (3SX) 90-91<br>SZR 660 96-97<br>FZR 750 Genesis 87<br>YZF 750 R/SP 93-97<br>FZR 1000 Genesis 87-88<br>FZR 1000 EX-UP 89-95<br>XJR 1200 95-98<br>XJR 1300 5EA1/5EA7 98-99<br><b>APRILIA</b><br>MX 125 04-06<br>RS 125 92-05<br>Tuono 125 03-04<br><b>DUCATI</b><br>Supersport 400 93-97<br>400 Monster 95-97<br>600 Monster 93-99<br>600 Monster Dark 98-99<br>600 Supersport 91-97<br>748 SP/Biposto 95-98<br>748 Racing/SPS 98<br>748 SPS 99<br>750 Supersport 91-99<br>750 Monster 96-98<br>750 Monster City/City Dark 99<br>750 Monster/Monster Dark 99<br>851 Superbike Biposto 89-92<br>888 SP4/SP5 92-93<br>888 Superbike Strada 94-95<br>900 Supersport/Superlight 91-97<br>900 Supersport 98-99<br>900 Supersport CR USA 98<br>900 Supersport FE 98<br>900 Monster 93-99<br>900 Monster Cromo/Special 98<br>900 Monster City/City Dark 99<br>907 IE 92-93<br>916 SP 94-96<br>916 Biposto-Senna 94-98<br>916 SPS (996cc) 98<br>996 98<br>996 S 01<br>998 R 02<br><b>LAVERDA</b><br>650 All models 94-95<br>668/750 All models 97-01<br>TTS 800 99-01 | 320   | MD2011               | REAR  | S     | RZ 250 R (1AR/1XG/29L) | 267                      |     |
|  |             |      | RZ 250 RR (51C)<br>RD 350 YPVS 83-84<br>RD 350 F/F2 85-92<br>RD 350 N 85<br>RD 350 R 92-95<br>T-Max XP500 04-07<br>XJ 600 84-91<br>FZ 750 87-91<br>FZR 750 Genesis 87<br>XJ 900 S 'Diversion' 95-03<br>FZR 1000 Genesis 87-88<br>FZR 1000 EX-UP 89-95<br>FZS 1000 Fazer 01-05<br>BT 1100 Bulldog P/R/S/T/V 02-06<br>XV 1100 99<br>XVS 1100 Dragstar 99-01<br>XVS 1100 A Dragstar Classic 00-01<br>XJR 1200 95-98<br>FJR 1300 N/P/R/AR/S/AS 01-04<br>XJR 1300 5EA1/5EA7 98-99<br>XJR 1300 L 5EA2/5EA3/5EA4 99<br>XJR 1300 M 5EA5/5EAB/5EAC 00<br>XJR 1300 (5EA9/5EAG) 00<br>XJR 1300 N/P (5EAP/5EAR/5EAS<br>/5EAT/5EAW/5EAW/5EAY) 01-02<br>XJR 1300 R/S 5WWM1/5WWM3/5WWM5<br>/5WWM6/5WWM7/5WWM9 03-04<br>XJR 1300 T/V/W 5WMA/5WMC/<br>/5WMD/5WMMF 05-07<br>XJR 1300 SP (L) 5EA5/5EA6/5EA8 99<br>XJR 1300 SP (M) 5EAD/5EAE/5EAF 00<br>XJR 1300 SP (N) 5EAL/5EAM/5EAN 01<br>MT-01 (1670 cc) 05-07   |   |                      |   |       |                        |                          |     |
| MD2008   | REAR        | S    | FZR 750 R 'OWO1'   | 89-90   | 210                  | MD2012LS<br>MD2012RS  | FRONT | S                      | XJ 900 S Diversion 95-03 | 320 |
| MD2009LS/RS<br>                   | FRONT       | F    | FZR 750 R 'OWO1'   | 89-90   | 320                  | MD2019LS<br>MD2019RS<br> | FRONT | D                      | RD 250/350 LC 80-83      | 266 |
|  |             |      | XS 250 C 78<br>XS 250 D/E 79-81<br>XS 250 SE/SF 79-81<br>XV 250 Virago 89-94<br>RD 350 LC 80-82<br>XS 360 C 76<br>XS 400 C 78<br>XS 400 79<br>XS 400 SE 80-81<br>XJ 550 81-84<br>XJ 650 RJ 'Seca' 82<br>XJ 650 80-84<br>XV 1000 Tri 81   |   |                      |   |       |                        |                          |     |
| MD2019<br>                        | REAR        | D    | XS 250 C 78<br>XS 360 C 76<br>XS 400 C 78  | 266   |                      |   |       |                        |                          |     |
|  |             |      |  |   |                      |   |       |                        |                          |     |

D = Dished Solid Original (We replace with floating rotor conversion unit) F = Floating Rotor S = Solid Rotor  
SF = Solid Flat Original Disc which we replace with fully floating unit - fits direct no mods required.

# STREETBIKE DISC BUYERS GUIDE

| DISC No.             | FRONT/ REAR | TYPE | MODELS   | DIA (MM) | DISC No. | FRONT/ REAR                    | TYPE  | MODELS     | DIA (MM)   |     |  |
|----------------------|-------------|------|--|----------|----------|--------------------------------|-------|------------|--|-----|--|
| MD2020LS/RS          | FRONT       | F    | FZR 400 Genesis (1WG)  | 86       | 282      | MD2056RS                       | FRONT | S          | TZR 125 90-92<br>SDR 200 (2TV) 87-89<br>SRX 250 (51Y/52E/1JA)  | 267 |  |
| MD2021               | REAR        | S    | TZR 125 90-92<br>TZR 125 R 93-<br>TZR 150 R 00<br>SDR 200 (2TV) 87-89<br>FX 250 Zeal (3YX1/2/4) 91-92<br>FZR 250 R<br>TDR 250 88-92<br>TZR 250 (2MA/2XW) 87-92<br>FZR 250<br>TZR 250 (3MA1) 89<br>TZR 250 (3MA3/A5) 90<br>TZR 250 SP (3MA4) 90<br>TZR 250 R (3XV1/4/6) 91<br>TZR 250 R (3XV8/9) 92-94<br>RIZ 350 92<br>FZR 400 Genesis (1WG) 86<br>FZR 400 RSP (2TK EX-UP) 87<br>FZR 400 (3EN1/2) 88-89<br>FZR 400 RR (3TJ1/2/6/7) 88-89<br>FZR 400 RR (4DX) 92<br>SZR 660 96-97 | 210      | MD2057   |                                |       | USE MD2021 |  |     |  |
|                      |             |      |  |          |          | MD2058LS/RS                    |       |            | USE MD2011LS/RS  |     |  |
|                      |             |      |  |          |          | MD2058                         |       |            | USE MD2011   |     |  |
|                      |             |      |  |          |          | MD2067LS<br>MD2067RS           | FRONT | S          | TZR 50 'Thunderkid' (SDU1/3) 97-00<br>TZR 50 X-Power 00<br>XV 125 Virago 97-00<br>XVS 125 Dragstar 00-04<br>SRV 250 "Soulfultwin<br>/Renaissa" 92-97<br>XV 250 S Virago 95-00<br>XVS 250 Dragstar 01-04<br>XV 750 Virago 94-97<br>XV 1100 Virago 94-99   | 280 |  |
|                      |             |      |  |          |          | MD2068LS<br>MD2068RS<br>MD2068 | FRONT | S          | FJ 1100 84-85<br>FJ 1200 (ITX) 86-87<br>FJ 1100 84-85<br>FJ 1200 (ITX/3CV/3XW) 86-95<br>FJ 1200 A (ABS Model) 91-95<br>V MAX 12 'All models' 91-02   | 282 |  |
|                      |             |      |  |          |          |                                | REAR  | S          |  | 282 |  |
| MD2022LS<br>MD2022RS | FRONT       | F    | TZR 125 R 93-<br>FZR 250 R (3LN) 87<br>FZR 400 RSP (2TK EX-UP) 87<br>FZR 400 (3EN1) 88   | 282      |          | MD2069LS<br>MD2069RS           | FRONT | S          | RD 500 LC 84-86<br>FZ 750 85-86<br>XJ 900/900F 83-86   | 267 |  |
|                      |             |      |  |          |          | MD2069                         | REAR  |            | FZX 700 S/SC/T/TC 'Fazer' 86-87<br>FZ 750 85-86<br>FZX 750 87  |     |  |
| MD2023LS<br>MD2023RS | FRONT       | D    | SR 500 78-82<br>XV 535 Virago 88-94<br>XJ 550 H/J/K 'Maxim' 81-83<br>XJ 550 RH/RJ/RK 'Seca' 81-83<br>XJ 650 G/H/J/K 'Maxim' 80-83<br>XJ 650 LH 'Midnight' 81<br>XJ 750 81-84   | 298      |          | MD2070                         | REAR  | S          | RD 500 LC 84-86  | 245 |  |
|                      |             |      |  |          |          | MD2073RS                       |       |            | USE MD2022RS   |     |  |
| MD2024LS<br>MD2024RS | FRONT       | D    | XS 500 C/D 78-79<br>XS 650 SE 79-<br>XV 750 SE 81<br>XS 850 80<br>XS 1100 78-80<br>XS 1100 S 81  | 298      |          | MD2074LS<br>MD2074RS           | FRONT | F          | YZF 600 R Thunder Cat 96-03<br>XJ 600 S 'Diversion' 98-03<br>XJ 600 N 98-03<br>YZF 600 R 'R6' 99-02<br>TDM 900 P/R/S/T/V 02-06<br>TDM 900 AT/AV/AW 05-07<br>FZS 1000 Fazer 01-04<br>XV 1900 A 06-07<br>YZF 1000 R Thunder Ace 96-02<br>YZF 1000 R1 98-03<br>BT 1100 P/R/S/T/V Bulldog 02-06<br>V-Max 12 93-03<br>FJR 1300 N/P 01-02<br>XJR 1300 L 5EA2/5EA3/5EA4 99<br>XJR 1300 M 5EAA/5EAB/5EAC 00<br>XJR 1300 (5EA9/5EAG) 00<br>XJR 1300 N/P (5EAP/5EAR/5EAS<br>/5EAT/5EAW/5EAW/5EAY) 01-02<br>XJR 1300 R/S 5WWM1/5WWM3/5WWM5<br>/5WWM6/5WWM7/5WWM9 03-04<br>XJR 1300 T/V/W 5WMA/5WMC/<br>/5WMD/5WWMF 05-07<br>XJR 1300 SP (L) 5EA5/5EA6/5EA8 99<br>XJR 1300 SP (M) 5EAD/5EAE/5EAF 00<br>XJR 1300 SP (N) 5EAL/5EAM/5EAN 01<br>XVS 1300 A Midnight Star 07<br>XV 1700 PCR Road Star Warrior 03-05 | 298 |  |
| MD2024               | REAR        | D    | XS 1100 78-80<br>XS 1100 S 81  | 298      |          | MD2074C                        |       |            |  |     |  |
| MD2025LS<br>MD2025RS | FRONT       | D    | RD 250 E/F 78-79<br>RD 400 E/F 78-79<br>XS 650 77-81<br>XS 650 SE 79-80<br>XS 750 77-79<br>XS 750 SE 79-80   | 266      |          |                                |       |            |  |     |  |
| MD2025               | REAR        | D    | RD 250 E/F 78-79<br>RD 400 E/F 78-79<br>XS 500 C/D 78-79<br>XS 750 77-79<br>XS 750 SE 79-80  | 266      |          |                                |       |            |  |     |  |
| MD2031LS             | FRONT       | S    | XJ 600 N 95-97<br>XJ 600 S Diversion 92-97   | 320      |          | MD2075                         | REAR  | S          | GTS 1000 93-99   | 282 |  |
| MD2033LS/RS          |             |      | USE MD2011LS/RS  |          |          | MD2076LS<br>MD2076RS           | FRONT | S          | XVS 400 96<br>XV 535/535 S Virago 95-03<br>XVS 650 Drag star 97-04<br>XVS 650 A Dragstar Classic 98-07<br>XVS 1100 Dragstar 99-04<br>XVS 1100 A Dragstar Classic 00-07<br>XVZ 13 AH/ATH Royal Star 96-00<br>XVZ 1300 TF 'Venture Star' 99-01<br>XV 1600 A 'Wildstar' 99-04   | 298 |  |
| MD2044LS/RS          |             |      | USE MD2024LS/RS  |          |          | MD2077                         | REAR  | S          | TZR 50 'Thunderkid' (SDU1/3) 97-00<br>TZR 50 X-Power 00  | 203 |  |
| MD2044               |             |      | USE MD2024   |          |          |                                |       |            |  |     |  |
| MD2046LS/RS          | FRONT       | F    | FJ 1200 A (ABS model) 91-95  | 298      |          |                                |       |            |  |     |  |
| MD2047               |             |      | USE MD2074LS/RS  |          |          |                                |       |            |  |     |  |
| MD2053RS             | FRONT       | S    | RD 125 LC (MK2/3) 85-87<br>RG 125 (1GV 030101-) 85<br>TZR 125 87-89  | 245      |          |                                |       |            |  |     |  |
| MD2055RS             |             |      | USE MD2053RS   |          |          |                                |       |            |  |     |  |

D = Dished Solid Original (We replace with floating rotor conversion unit) F = Floating Rotor S = Solid Rotor  
SF = Solid Flat Original Disc which we replace with fully floating unit - fits direct no mods required.

# STREETBIKE DISC BUYERS GUIDE

| DISC No.               | FRONT/ REAR | TYPE | MODELS   | DIA (MM) | DISC No.                        | FRONT/ REAR | TYPE | MODELS  | DIA (MM) |
|------------------------|-------------|------|--|----------|---------------------------------|-------------|------|---|----------|
| MD2078                 | REAR        | S    | XVZ 13 AH/ATH Royal Star 96-00<br>XVZ 1300 TF 'Venture Star' 99-01   | 320      | MD2103                          | REAR        | S    | XVS 1300 A Midnight Star 07   | 298      |
| MD2081LS/RS            | FRONT       | S    | XVZ 12 TD 85   | 298      | MD3001LS<br>MD3001RS            | FRONT       | S    | GSXR 400 H 87<br>GSX 400 RS (GK71F)<br>GSX 400 X/XA/XS<br>GSX 600 FJ 88   | 290      |
| MD2081                 | REAR        | S    | XVZ 12 TD 85   |          |                                 |             |      |   |          |
| MD2082LS/RS<br>MD2082C | FRONT       | F    | YZF R6 03-04<br>FZ6 Fazer/Fazer A 04-07<br>FZ6 Naked version 04-07<br>FZ6 S2 ABS (Naked) 07<br>FZ6 Fazer S2 (ABS) 07<br>MT-03V (660cc) 06-07                           | 298      | MD3002<br>MD3002C               | REAR        | S    | GSF 250 N/ZM/P/NP/ZP/R/NR/V/S 92-97<br>GSX 250 SSM Katana 91<br>GSF 400 M/N/P Bandit 91-95<br>GSX 400 FJ/FK/FAK/FL (GK74A) 88-90<br>GSX 400 R/S/T/X/ZR/ZS/ZT Impulse Type S 94-99<br>GSX 400 SSN Katana 92<br>GSF 400 K/NK/Z/V/M/ZM/P/NP /NP/ZP/VR Bandit (GK75A) 89-94<br>GS 500 EK/EL/EM/EN/EP/ER/ES /ET/EV/EW/EX/EY/K1/K2/K3/K4 FK4/FK5/K5/K6/FK6/K7/FK7 89-07<br>GSX 600 FJ/FK/FL/FM/FN/FP /FR/FS/FT/FV 88-97<br>GSX 750 FK/FL/FM/FN/FP/FR/FS/FT/FV 89-96   | 250      |
| MD2083LS/RS            | FRONT       | F    | YZF-R7 750 'OWO2' 99-00  | 320      | MD3003LS<br>MD3003RS<br>MD3003C | FRONT       | F    | RGV 250 J/K/L 88-90<br>GSXR 250 RK (GJ73A) -89<br>GSX 400 FJ/FK/FAK/FL (GK74A) 88-90<br>GSX 400 R/S/T/ZR/ZS/ZT Impulse type 94-96<br>GSX 400 X 99<br>GSX 400 FSV/FSK1 (GK7B) Inazuma 00<br>GSX 400 SSN Katana 92<br>GSF 400 K/NK/Z/V/M/ZM/P/NP/VP /VZP/VR Bandit (GK75A) 89-94<br>GSF 400 S/V/S/V-V /VZ-V Bandit 95-97<br>GSXR 400 J/RR/RAK (GK73A) 88-90<br>RF 400 RP/RR/RS/RT/RTV/RV-V 93-97<br>GSF 600 S/T/ST/V/SV/W/SW/X/SX /Y/SY/K1/SK1/K2/SK2/SK3/K3 /K4/SK4 Bandit 95-04<br>RF 600 RP/RR/RS/RT/RV 93-97<br>GSX 600 FK/FL/FM/FN/FP FR/FS/FT/FV 89-97<br>GSX 600 FW/FX/FY/FK1/FK2 98-02<br>SV 650 X/SX/Y/K1/K2/SK1/SK2 99-02<br>GSX 750 FK/FL/FM/FN/FP/FR/FS/FT/FV 89-97<br>GSX 750 FW/FX/FY/FK1/FK2 98-02 | 290      |
| MD2084<br>MD2084C      | REAR        | S    | YZF 600 R 'R6' 99-02<br>YZR 1000 R1 02-03  | 220      |                                 |             |      |   |          |
| MD2085LS               | FRONT       | S    | SR 125 97-03   | 267      |                                 |             |      |   |          |
| MD2086<br>MD2086C      | REAR        | S    | YZF R7 OWO2 (Road version) 99-01<br>YZF R1 98-01   | 245      |                                 |             |      |   |          |
| MD2087LS               | FRONT       | S    | XP 500 N/P/R/S T-Max 01-04   | 282      |                                 |             |      |   |          |
| MD2088                 | REAR        | S    | XV 1600 A Wildstar 99-04   | 320      |                                 |             |      |   |          |
| MD2089LS/RS            | FRONT       | F    | FJR 1300 R/AR/S/AS/AT/T (ABS) /AV/ASV/AW/ASW 03-07<br>FJR 1300 AS (2D21) 06-07   | 320      |                                 |             |      |   |          |
| MD2090LS/RS            | FRONT       |      | USE MD2074LS/RS  |          |                                 |             |      |   |          |
| MD2091<br>MD2091C      | REAR        | S    | YZF R6 03-07<br>YZF-R6 S 07<br>YZF R1 04-07<br>YZF-R1SP 06   | 220      |                                 |             |      |   |          |
| MD2092                 | REAR        | S    | XVS 1100 Dragstar 99-04<br>XVS 1100 A Dragstar Classic 00-07<br>FJR 1300 R/AR/S/AS/T/AT (ABS) 03-05<br>XV 1700 PCR Road Star Warrior 03-05                             | 282      |                                 |             |      |   |          |
| MD2093<br>MD2093C      | REAR        | S    | FZ1-N/NV (SD2) 06-07<br>FZ1S 3C3 06-07<br>FZ6 Fazer/Fazer A 04-07<br>FZ6 Naked version 04-07<br>FZ6 S2 ABS (Naked) 07<br>FZ6 Fazer S2 (ABS) 07<br>MT-03V (660cc) 06-07 | 245      |                                 |             |      |   |          |
| MD2094LS/RS<br>MD2094C | FRONT       | F    | YZF R1 04-06<br>MT-01 (1670cc) 05-07   | 320      | MD3004LS/RS                     | FRONT       | F    | GSXR 1100 G/H/J 86-88   | 310      |
| MD2095LS/RS            | FRONT       | F    | YZF R6 05-07<br>YZF-R6 S 07  | 310      | MD3005LS/RS                     | FRONT       | F    | GSXR 750 F/G/H/RG 85-87   | 300      |
| MD2095C                |             |      |  |          | MD3006LS<br>MD3006RS<br>MD3006C | FRONT       | F    | GSF 250 N/ZM/P/NP/ZP/R/NR/V/S 92-97<br>GSX 250 SSM Katana 91<br>GSF 400 M/N/P Bandit 91-95<br>GSR 400 K6 06<br>GS 500 EK/EL/EM/EN/EP/ER/ES /ET/EV/EW/EX/EY/K1/K2/K3/K4 /FK4/K4/FK5/K5/K6/FK6/K7/FK789-07<br>GSXR 600 K6 06<br>RF 900 RR/RS/RS2/RT/RV/RW 94-98<br>GSX 1200 FSW/FSX 'Inazuma' 98-99<br>GSF 1200 T/ST/V/SV/SW/X/SX /Y/SY/SK1/K1/K2/SK2/K3/SK3 /K4/SK4/SK5/K5 Bandit 96-05<br>GSF 1200 K6/SAK6 06   | 310      |
| MD2097RS               | FRONT       | S    | YBR 125 ED (3D91) 05-07  | 245      | MD3007LS<br>MD3007RS            | FRONT       | F    | TV 250 J/K/AK/L Wolf 88-90<br>GSXR 750 J/K/L/M/WN/ WP/WR/WS 88-95<br>GSXR 1100 K/L/M/N/WP /WR/WS/WT 89-96   | 310      |
| MD2098LS/RS            | FRONT       | F    | T-Max XP 500 04-07   | 267      | MD3007C                         |             |      |   |          |
| MD2099                 | REAR        | S    | XV 1900 Midnight Star 06-07  | 320      |                                 |             |      |   |          |
| MD2100                 | REAR        | S    | FJR 1300 AV/ASV/AW/ASW 06-07<br>FJR 1300 AS (2D21) 06-07   | 282      |                                 |             |      |   |          |
| MD2101LS<br>MD2101RS   | FRONT       | F    | FZ1 N/NV (2D112/3) 06-07<br>FZ1 Fazer S (3C3) 06-07  | 320      |                                 |             |      |   |          |
| MD2102LS/RS            | FRONT       | F    | YZF R1 07  | 310      |                                 |             |      |   |          |

D = Dished Solid Original (We replace with floating rotor conversion unit) F = Floating Rotor S = Solid Rotor  
SF = Solid Flat Original Disc which we replace with fully floating unit - fits direct no mods required.





















# STREETBIKE DISC BUYERS GUIDE

| DISC No.  | FRONT/ REAR | TYPE | MODELS   | DIA (MM) | DISC No.                           | FRONT/ REAR | TYPE | MODELS                             | DIA (MM) |
|---|-------------|------|--|----------|------------------------------------|-------------|------|------------------------------------|----------|
| <b>MD3008</b><br><b>MD3008C</b>   | REAR        | S    | RF 400 RP/RR/VR/RT/RVT/RV-V 93-97  | 240      | <b>MD3019LS</b><br><b>MD3019RS</b> |             | D    | GT 500 A/B 75-78                   | 296      |
|   |             |      | GSX 400 FSV/FSK1 Inazuma 00  |          |                                    |             |      | RE5 M/A 75-77                      |          |
|   |             |      | GSF 600 S/T/ST/V/SV/W/SW/X/SX/Y/SY /K1/K2/SK1/SK2/K3/SK3/K4/SK4 Bandit 95-04   |          |                                    |             |      | GT 550 K/L/M/A/B 73-77             |          |
|   |             |      | RF 600 RP/RR/RS/RT/RV 93-97  |          |                                    |             |      | GT 750 K/L/M/A/B 73-77             |          |
|   |             |      | GSX 600 FW/FX/FY/FK1/FK2/FK3/FK4 98-04   |          |                                    |             |      | GT 750 B 77                        |          |
|   |             |      | GSXR 600 K6 06   |          |                                    |             |      |                                    |          |
|   |             |      | GSF 650 K5/SK5 Bandit 05   |          |                                    |             |      |                                    |          |
|   |             |      | GSF 650 K6/SK6/K7/SK7 06-07  |          |                                    |             |      |                                    |          |
|   |             |      | SV 650 X/Y/K1/K2 99-02   |          |                                    |             |      |                                    |          |
|   |             |      | SV 650 SX/SY/SK1/SK2 99-02   |          |                                    |             |      |                                    |          |
|   |             |      | GSX 750 FW/FX/FY/FK1/FK2/FK3 /FK4/FK5/FK6 98-06  |          |                                    |             |      |                                    |          |
|   |             |      | GSXR 750 J/K/L/M/WN/ WP/WR/WS 88-95  |          |                                    |             |      |                                    |          |
|   |             |      | GSX 750 W/X/Y/K1 98-03   |          |                                    |             |      |                                    |          |
|   |             |      | GSX 750 FK3/FK4/FK5/FK6 03-06  |          |                                    |             |      |                                    |          |
|   |             |      | RF 900 RR/RS/RS2/RT/RV/RW 94-99  |          |                                    |             |      |                                    |          |
| GSX 1100 K/L/M/N/WP/ WR/WS/WT 89-96   |             |      |  |          |                                    |             |      |                                    |          |
| GSF 1200 T/ST/V/SV/SW/X/SX /Y/SY/SK1/K1/K2/SK2/K3/SK3 /K4/SK4/SK5/K5 Bandit 96-05 |             |      |  |          |                                    |             |      |                                    |          |
| GSF 1200 FSW/FSX 'Inazuma' 98-99  |             |      |  |          |                                    |             |      |                                    |          |
| GSF 1200 K6/SAK6 06   |             |      |  |          |                                    |             |      |                                    |          |
| GS 1200 SSK1/ZK1 01   |             |      |  |          |                                    |             |      |                                    |          |
| GSX 1300 RX/RV/RK1/RK2/RK3 /RK3/RK4/RK5/K6 99-06                                  |             |      |  |          |                                    |             |      |                                    |          |
| <b>MD3009</b>   | REAR        | S    | GSXR 750 F/G/H/RG 85-87<br>GSXR 1100 G/H/J 86-88   | 220      |                                    |             |      |                                    |          |
| <b>MD3010LS</b>   | FRONT       | S    | RB 50 H 'GSXR 50' 87   | 162      |                                    |             |      |                                    |          |
| <b>MD3014LS</b><br><b>MD3014RS</b>  | FRONT       | D    | GN 250 F/J/M/R/T 87-97   | 276      | <b>MD3030LS</b><br><b>MD3030RS</b> |             | S    | GV 1200 GLF/GLF2/GLG Madura 85-86  | 276      |
|   |             |      | GT 250 K/L/M/N/A/B/C 73-78   |          |                                    |             |      |                                    |          |
|   |             |      | GSX 250 ET/EX/EZ 80-82   |          |                                    |             |      |                                    |          |
|   |             |      | GS 250 TT/TX 80-81   |          |                                    |             |      |                                    |          |
|   |             |      | RG 250 WD/WE 83-84   |          |                                    |             |      |                                    |          |
|   |             |      | GT 380 K/L/M/A/B 73-77   |          |                                    |             |      |                                    |          |
|   |             |      | GS 400 B/C 77-78   |          |                                    |             |      |                                    |          |
|   |             |      | GSX 400 ET/EX/EZ 81-83   |          |                                    |             |      |                                    |          |
|   |             |      | GN 400 TT 80   |          |                                    |             |      |                                    |          |
|   |             |      | GSX 400 LX/TX 81   |          |                                    |             |      |                                    |          |
|   |             |      | GS 425 EN 78-80  |          |                                    |             |      |                                    |          |
|   |             |      | GS 450 ET/EG/EJ 80-88  |          |                                    |             |      |                                    |          |
|   |             |      | GS 550 DB/DC/EC/EN 77-79   |          |                                    |             |      |                                    |          |
|   |             |      | GS 650 GTX/GTZ/GTD/GX/GZ 81-83   |          |                                    |             |      |                                    |          |
|   |             |      | GR 650 D/XD Tempter 83   |          |                                    |             |      |                                    |          |
|   |             |      | GS 750 DB/DC/EC/EN 77-80   |          |                                    |             |      |                                    |          |
|   |             |      | GSX 750 ET/EX 80-81  |          |                                    |             |      |                                    |          |
|   |             |      | GSX 750 SE Katana 85   |          |                                    |             |      |                                    |          |
|   |             |      | GSX 750 SE 85  |          |                                    |             |      |                                    |          |
|   |             |      | GS 850 GN/GT/GX 79-81  |          |                                    |             |      |                                    |          |
|   |             |      | GS 850 GZ/GE/GG 82-85  |          |                                    |             |      |                                    |          |
|   |             |      | GS 1000 HC/EC/EN/SN/ET 78-81   |          |                                    |             |      |                                    |          |
|   |             |      | GS 1000 GT/GX 81-82  |          |                                    |             |      |                                    |          |
|   |             |      | GSX 1000 SZ Katana 82  |          |                                    |             |      |                                    |          |
|   |             |      | GS 1100 GZ 82  |          |                                    |             |      |                                    |          |
| GSX 1100 ET/EX/EZ/ESD 80-83   |             |      |  |          |                                    |             |      |                                    |          |
| GSX 1100 SZ/SD 82-83  |             |      |  |          |                                    |             |      |                                    |          |
| <b>MD3014</b>   | REAR        | D    | GS 550 EC/EN/ET/EX/EZ /LT/LX/MX/MZ 78-84   | 276      | <b>MD3031LS</b><br>(5 bolt)        |             | S    | VS 700 GLFG/GLPG 86-87             | 296      |
|   |             |      | XN 85 Turbo 83   |          |                                    |             |      | VS 750 GLF/GLPG/GLFG 85-90         |          |
|   |             |      | GS 750 B/DB/DC/EC/EN 77-80   |          |                                    |             |      |                                    |          |
|   |             |      | GSX 750 ET/EX 80-81  |          |                                    |             |      |                                    |          |
|   |             |      | GSX 750 S/SS Katana 84   |          |                                    |             |      |                                    |          |
|   |             |      | GSX 750 S-2/S-2C Katana 84   |          |                                    |             |      |                                    |          |
|   |             |      | GS 850 GN/GT/GX 79-81  |          |                                    |             |      |                                    |          |
|   |             |      | GS 1000 GT/GX 81-82  |          |                                    |             |      |                                    |          |
|   |             |      | GSX 1000 SZ Katana 82  |          |                                    |             |      |                                    |          |
|   |             |      | GSX 1100 ET/EX/EZ/ESD 80-83  |          |                                    |             |      |                                    |          |
|   |             |      | GSX 1100 SZ/SD 'Katana' 82-83  |          |                                    |             |      |                                    |          |
|   |             |      |  |          |                                    |             |      |                                    |          |
| <b>MD3032LS</b><br><b>MD3032RS</b>  | FRONT       | SF   | VS 400 VR/FR/VTR/FTR/ V-T/F-T Intruder 94-96<br>VS 600 GLS/GLT 95-96<br>VS 700 GLFH/GLPH 86-87<br>VS 750 GLFH/GLPH 'Intruder' Spoke Wheel 87<br>VS 750 GLPK/GLPL/GLPM 'Intruder' 'Spoke wheel' 88-91<br>VS 800 GLN/GLP/GLR/GLS/GLT /GLV/GLW/GLX 'Intruder' 92-99<br>VS 1400 GLPH/GLFH/GLPJ/GLFJ /GLPR/GLPT/GLPV/GLPW/GLPX /GLPY/GLPK1 Intruder 87-02 |          |                                    |             |      |                                    |          |
| <b>MD3033LS</b>   | FRONT       | S    | VX 800 L/M/N/P/R 90-96   | 310      |                                    |             |      |                                    |          |
| <b>MD3034LS/RS</b>  |             |      | <b>USE MD3014LS/RS</b>   |          |                                    |             |      |                                    |          |
| <b>MD3036</b>   | REAR        | S    | GSX 1100 FJ/FK/FL/FN/FM/FP 89-93   | 276      |                                    |             |      |                                    |          |
| <b>MD3037LS/RS</b>  | FRONT       | S    | GSX 1100 GM/GN 91-94   | 310      |                                    |             |      |                                    |          |
| <b>MD3038</b>   | REAR        | S    | GSX 1100 GM/GN 91-94   | 295      |                                    |             |      |                                    |          |
| <b>MD3039LS</b><br><b>MD3039RS</b>  | FRONT       | F    | GSX 1100 EFE/EFF/ESE 84-86   | 276      | <b>MD3039</b><br><b>MD3039RS</b>   |             | F    | GSX 1100 EFE/EFF/ESE 84-86         | 276      |
|   |             |      | GSX 1100 FJ/FK/FL/FN/FM/FP 89-93   |          |                                    |             |      |                                    |          |
| <b>MD3041</b>   | REAR        | D    | GV 1200 GLF/GLF2/GLG Madura 85-86  | TBA      |                                    |             |      |                                    |          |
| <b>MD3042LS</b><br><b>MD3042RS</b>  | FRONT       | S    | GV 1400 Cavalcade All models 85-88   | 275      | <b>MD3043</b>                      |             | S    | GV 1400 Cavalcade All models 85-88 | 295      |
|   |             |      |  |          |                                    |             |      |                                    |          |
| <b>MD3044</b>   | REAR        | S    | VS 1400 GLPH/GLFH/GLPJ/GLFJ /GLPR/GLPT/GLPV/GLPW/GLPX /GLPY/GLPK1/GLPK2 Intruder 87-03   | 278      |                                    |             |      |                                    |          |

DISC BUYERS GUIDE

D = Dished Solid Original (We replace with floating rotor conversion unit) F = Floating Rotor S = Solid Rotor SF = Solid Flat Original Disc which we replace with fully floating unit - fits direct no mods required.

# STREETBIKE DISC BUYERS GUIDE

| DISC No.  | FRONT/ REAR | TYPE | MODELS  | DIA (MM) | DISC No.   | FRONT/ REAR | TYPE | MODELS  | DIA (MM) |
|---|-------------|------|---|----------|--|-------------|------|---|----------|
| MD3045LS<br>MD3045RS<br> | FRONT       | F    | RG 125 UN 'Wolf' 92-94<br>RG 125 FUN/FUP/FUR 'Gamma' 92-96<br>RGV 250 M/N/P/R/S 91-95<br>GSXR 400 RL/RM/RN/RP /RS (GK76A) 90-95<br>GSX 750 W/X/Y/K1 98-03<br>VZ 800 V/W/X/Y/K1/K2 'Marauder' 97-03  | 300      | MD3075LS<br>MD3075RS<br>             | FRONT       | F    | GSF 1200 SAV ABS Bandit 97  | 310      |
|   |             |      |   |          | MD3076   | REAR        | S    | GSF 1200 SAV ABS Bandit 97  | 276      |
|   |             |      |   |          | MD3077LS/RS  |             |      | <b>USE MD3045LS/RS</b>  |          |
| MD3048LS  | FRONT       | S    | RG 125 UCG/UCH/UCJ/J/ BUJ 'Gamma' 85-91   | 260      | MD3078RS   | FRONT       | S    | VL 1500 W/X/Y/K1 'Intruder Legendary Classic' 98-01   | 300      |
| MD3051  |             |      | <b>USE MD3059</b>   |          | MD3079<br>                            | REAR        | F    | VL 1500 W/X 'Intruder Legendary Classic' 98-02  | 276      |
| MD3058LS<br>MD3058RS<br> | FRONT       | F    | GSXR 600 V/W/X/Y/SY/K1-K3/ZK3 97-03<br>GSXR 750 T/V/W/X/Y/K1-K3 96-03<br>GSXR 1000 K1/K2 01-02<br>TL 1000 SV/SW/RW/SX/RX/RV/K1/SK1 97-02<br>GS 1200 SSK1/ZK1 01<br>GSX 1300 RX/RV/RK1/RK3/RZK3/RK3 /RK4/RK5/K6 'Hayabusa' 99-06<br>GSX 1400 K1-K7 01-07 | 320      | MD3080RS<br>                          | FRONT       | F    | SG 350 N 'Goose' 92   | 299      |
| MD3058C<br>              |             |      |   |          | MD3081   | REAR        | S    | RGV 250 J/K/L 88-90<br>TV 250 J/K/AK/L Wolf 88-90<br>SG 350 N 'Goose' 92<br>GSXR 400 RL/RM/RN/RP /RS (GK76A) 90-95<br>GSXR 400 J/R/RAK (GK73A) 88-90  | 210      |
| MD3059  | REAR        | S    | RG 125 FUN/FUP/FUR 92-96<br>RG 125 UN 'Wolf' 92-94<br>RGV 250 M/N/P/R/S/T 91-96<br>GSXR 250 J (GJ72A)<br>GSXR 250 CK  | 210      | MD3082LS/RS<br>                       | FRONT       | F    | RGV 250 T (RGVR 250 SP) 96  | 290      |
| MD3060<br>MD3060C   | REAR        | S    | GSXR 600 V/W/X/Y/K1/K2/K3 /ZK3/K4/K5/K6/K7 97-07<br>SV 650 SK3/K3/K4/SK4/SK5/K5 /K6/SK6/K7/SK7 03-07<br>GSXR 750 T/V/W/X/Y/K1-K7 96-07<br>GSXR 1000 K1-K7 01-07<br>SV 1000 SK3/K3/K4/SK4/K5/SK5/SK6 TL 1000 SV/SW/RW/SX/RX SY/RV/RK1/SK1 97-02          | 220      | MD3083/C   | REAR        | S    | GSX 1400 K1-K7 01-07  | 260      |
|   |             |      |   |          | MD3084   | REAR        | S    | GSF 400 S/S/V/VZ-V Bandit 95-97   | 250      |
| MD3061  | REAR        | S    | VX 800 L/M/N/P/R 90-96  | 250      | MD3086<br>                          | REAR        | F    | VL 1500 Y/K1/K2/K3 Intruder Legendary Classic 00-03<br>VL 1500 K5/K6/K7 (C 1500 Intruder) 05-07<br>VZR 1800 K6/K7 (M 1800 R Intruder) 06-07   | 276      |
| MD3063  |             |      | <b>USE MD3059</b>   |          | MD3087LS<br>MD3087RS   | FRONT       | S    | VL 1500 K2/K3/K5/K6/K7 Intruder Legendary Classic 02-03/05-07   | 290      |
| MD3064  | REAR        | S    | RG 250 WD/WE 83-84<br>RG 250 FG/CH/FCH/FH Gamma 85-88<br>GSX 250 R CH/H (GJ72A)<br>GSX 400 R2 (GK71B)<br>GSX 400 R3 (GK71F)<br>GSX 400 X/XA/XS Impulse<br>RG 400 EWF/EW-2G/EWH Walter Wolf 85-87<br>RG 500 G/CH 85-87<br>GSXR 400 H 87                  | 210      | MD3088LS/RS<br>                     | FRONT       | F    | DL 650 K4/K5/K6 04-05<br>DL 1000 K2-K7 02-07<br>SV 1000 K3/SK3/K4/SK4/K5/SK5/SK6 03-06  | 310      |
|   |             |      |   |          | MD3088C<br>                         |             |      |   |          |
| MD3065LS/RS   |             |      | <b>NOT BEING MADE</b>   |          | MD3089LS<br>MD3089RS<br>           | FRONT       | F    | GSXR 600 K4/K5 04-05<br>GSXR 750 K4/K5 04-05<br>GSXR 1000 K3/K4 03-04   | 300      |
| MD3066LS/RS<br>        | FRONT       | D    | GSX 400 FX/FZ/FD 81-83  | 276      | MD3089C<br>                         |             |      |   |          |
| MD3067  |             |      | <b>USE MD3025</b>   |          | MD3090LS/RS<br>                     | FRONT       | F    | GSX 600 FK3/FK4/FK5/FK6 03-06<br>GSF 650 K5/SK5/K6/SAK6 Bandit 05-06<br>GSF 650 K6/SK6/K7/SK7 06-07<br>GT 650 X 07<br>SV 650 SK3/K3/K4/SK4/K5/SK5 /K6/SK6/K7/SK7 03-07<br>GSX 750 FK3/FK4/FK5/FK6 03-06 | 290      |
| MD3068LS/RS   |             |      | <b>USE MD3001LS/RS</b>  |          | MD3090C<br>                         |             |      |   |          |
| MD3069  |             |      | <b>USE MD3064</b>   |          | MD3091LS/RS<br>                     | FRONT       | F    | GSXR 600 K6/K7 06-07<br>GSXR 750 K6/K7 06-07<br>GSXR 1000 K5/K6/K7 05-07<br>VZR 1800 K6/K7 06-07  | 310      |
| MD3070LS/RS<br>        | FRONT       | F    | RG 500 G/CH 85-87<br>RG 400 EWF/EW-2G/EWH Walter Wolf 85-87   | 260      | MD3091C<br>                         |             |      |   |          |
| MD3071  |             |      | <b>USE MD3064</b>   |          | MD3092LS<br>MD3092RS<br>MD3092C<br> | FRONT       | F    | GSR 400 K6 06<br>GSR 600 K6/AK7 06-07<br>GSF 650 AK7/ASK7/AK6/ASK6 06-07<br>DL 650 AK7 VStrom ABS 07<br>DL 650 K7 07<br>GSF 1200 SAK6/AK6/GTSAK6 06<br>GSF 1250 AK7/ASK7 Bandit 07                      | 310      |
| MD3072RS  |             |      | <b>USE MD3045RS</b>   |          |  |             |      |   |          |
| MD3073LS<br>           | FRONT       | SF   | VS 700 GLEFG/GLEPG /GLEFH/GLEPH 86-87<br>VS 750 GLEFH/GLEPH 'Intruder' 'Cast wheel' 87  | 296      |  |             |      |   |          |
| MD3074LS<br>MD3074RS  | FRONT       | S    | GSX 250 R CH/H (GJ72A)<br>GSXR 250 J (GJ72A)<br>GSXR 250 CK   | 275      |  |             |      |   |          |















D = Dished Solid Original (We replace with floating rotor conversion unit) F = Floating Rotor S = Solid Rotor SF = Solid Flat Original Disc which we replace with fully floating unit - fits direct no mods required.

# STREETBIKE DISC BUYERS GUIDE

| DISC No.                             | FRONT/ REAR | TYPE | MODELS  | DIA (MM) | DISC No.   | FRONT/ REAR | TYPE | MODELS  | DIA (MM) |
|--------------------------------------|-------------|------|---|----------|--|-------------|------|---|----------|
| <b>MD3093</b><br><b>MD3093C</b>      | REAR        | S    | GSR 400 K6 06<br>GSR 600 K6/AK7 06-07<br>GSF 650 AK7/ASK7/AK6/ASK6 06-07<br>SV 650 AK7/SAK7 ABS 07<br>GSF 1200 SAK6/AK6/GTSAK6 06<br>GSF 1250 AK7/ASK7 Bandit 07  | 240      | <b>MD4010LS</b><br><b>MD4010RS</b><br>5mm disc thickness | FRONT       | S    | Z 250 A3 81<br>Z 400 J2-J3 81-83<br>Z 440 D5-D6 'Ltd' 83-84<br>Z 440 C2/H1-H2 81-83<br>Z 550 A2-A3 81-82<br>Z 550 C1-C2 Ltd 82-84<br>GPZ 550 D1 82<br>Z 650 F2-F4 80-83<br>VN 700 A1 'Vulcan' 85<br>Z 700 A1 Ltd 84<br>Z 750 E1 80<br>GPZ 750 R1 82<br>GT 750 P1-P9 82-96<br>Z 750 H1-H2 Ltd 80-81<br>Z 750 N1/N2 Spectre 82-83<br>Z 750 L1-L4 81-84<br>VN 750 A2-A5/10 86-94 | 260      |
| <b>MD3094LS/RS</b><br><b>MD3094C</b> | FRONT       | F    | SV 650 AK7/SAK7 ABS 07  | 290      | <b>MD4010</b><br>7mm disc thickness                      | REAR        | S    | GPZ 550 D1 82<br>Z 700 A1 Ltd 84<br>GPZ 750 R1 82<br>GT 750 P1-P9 82-96<br>Z 750 E1 80<br>Z 750 H1-H2 Ltd 80-81<br>Z 750 N1/N2 Spectre 82-83<br>Z 750 L1-L4 81-84   | 260      |
| <b>MD3095</b>                        | FRONT       | S    | VL 800 K1-K6 01-06  | 300      |  |             |      |   |          |
| <b>MD3096RS</b>                      | FRONT       |      | VZ 800 K5-K7 Intruder M800 05-07  |          |  |             |      |   |          |
| <b>MD4001</b>                        | REAR        | S    | Z 400 C2/C3 (Z 400 F2) 85-87<br>GPZ 550 A1-A4 84-87   | 260      |  |             |      |   |          |
| <b>MD4002LS</b><br><b>MD4002RS</b>   | FRONT       | S    | EL 252 F2 (EX 250 F2/F5) 97-03<br>EL 250 D1-D5 90-94<br>EL 250 'Eliminator' 87-89<br>GPX 250 R (EX 250 E) 86<br>GPZ 550 A1-A4 84-87   | 260      |  |             |      |   |          |
| <b>MD4004LS/RS</b>                   |             |      | <b>USE MD4099LS/RS</b>  |          | <b>MD4012LS</b><br><b>MD4012RS</b>                       | FRONT       | F    | ZXR 750 H1-H2 89-90<br>ZX9R (ZX 900 E1/E2) 00-01<br>ZR 1100 A1-A4 'Zephyr' 92-95<br>ZR 1100 B1 'Zephyr' 96-97<br>ZZR 1100 C1-C3 90-92<br>ZX 1200 A1-A5/A6F/B1-B3 01-07<br>ZR 1100 C1-C4 97-00<br>ZR 1100 B5 02  | 310      |
| <b>MD4005LS/RS</b>                   | FRONT       | F    | ZXR 400 L1-L9 91-03<br>ZXR 400 R (ZX 400 M1-M4) 91-94   | 310      | <b>MD4012C</b>   |             |      |   |          |
| <b>MD4006LS</b><br><b>MD4006RS</b>   | FRONT       | S    | EN 450 A1-A5 86-89<br>EN 500 A1-A3 90-93<br>GT 550 G1-G9 83-01<br>Z 1000 J1/J2 81-82<br>Z 1000 K1 'Ltd' 83<br>GPZ 1100 B1 82<br>Z 1100 D1/D2 'Spectre' 82-83<br>Z 1100 A1-A3 81-83  | 270      | <b>MD4013</b><br><b>MD4013C</b>                          | REAR        | S    | ZXR 750 H1/H2/K1/K2/J1 /J2/M1/M2/L1-L3/P1-P7 /N1/N2 89-03<br>ZX 9R (ZX 900 B1-B4) 94-97   | 230      |
| <b>MD4007</b>                        | REAR        | S    | ZZR 400 (ZX 400 K1/2/3) 90-92<br>ZZR 600 D1-D3 90-93<br>GPX 750 R F1-F3 87-89<br>ZR 750 C1-C5/D1 Zephyr 92-   | 230      | <b>MD4014</b>  | REAR        | S    | ZZR 1100 D1-D9 93-01  | 250      |
| <b>MD4008LS</b><br><b>MD4008RS</b>   | FRONT       | F    | KR-1S (KR 250 C2/C3) 90-92<br>ZR 250 A1-A5 91-95<br>ZR 250 B6 (Balius-II) 02<br>ZXR 250 A1/A2/B1/B2 89-90<br>ZZR 250 (EX 250 H1-H13) 90-03<br>ZRX 400 (ZR 400 E1-E7) 94-01<br>ZXR 400 H1/H2 89-90<br>ZXR 400 J1/J2 89-90<br>ZZR 400 (ZX 400 K1-K3/N1-N7) 90-99<br>ZR 550 B2-B6 91-99<br>ZX6-R F1-F3 95-97<br>ZL 600 B1 95-97<br>EJ 650 A1/C3-C7 (E650) 00-05<br>ZR 750 C1-C5/D1 Zephyr 92-<br>GPZ 900 A7/A8 90-96<br>GPZ 900 R (ZX 900 A11) 98<br>ZG 1000 A9-A18 94-03<br>GPZ 1100 E1/E2/F1 95-98 | 300      | <b>MD4015</b>  | REAR        | S    | FX 400 R (ZX 400 E1-E3) 86-88<br>GPZ 400 R (ZX 400 D1/D3/D3A) 85-87<br>GPZ 600 R A1-A5A 85-89<br>GPZ 900 A7-A8 90-96<br>GPZ 900 R (ZX 900 A11) 98<br>GPZ 900 R (ZX 900 A12-15) 99-02<br>ZX 1000 B1-B3 (ZX10) 88-90<br>ZZR 1100 C1-C3 90-92  | 250      |
| <b>MD4008C</b>                       |             |      |   |          | <b>MD4016LS</b><br><b>MD4016RS</b>                       | FRONT       | S    | ZL 400 A 'Eliminator' 86-87<br>ER-5 (ER 500 A1/A2/A3/A4/C1-C5P) 97-07<br>GPZ 500 'S' (EX 500 A1-A6) 87-93<br>GPZ 500 'S' (EX 500 D1-D9) 94-02<br>GPZ 750 R G2-G3 85-86<br>GPZ 750 E1/E2 Turbo 84-87<br>GPZ 900 R A1-A6 84-89<br>ZL 900 A1/A2 'Eliminator' 85-86<br>GPZ 1000 RX (A1-A3) 86-88<br>ZL 1000 A1 87<br>GPZ 1100 A1-A3 83-85   | 280      |
| <b>MD4009</b><br><b>MD4009C</b>      | REAR        | S    | ZXR 400 L1-L9 91-03<br>ZXR 400 H1/H2 89-90<br>ZXR 400 J1/J2 89-90<br>ZXR 400 (M1-M4) 91-94<br>ZX-4 (ZX 400 G1/G1A/G1B) 88<br>ZR 400 Zephyr 97-01<br>ZR 400 Zephyr (G2/G3/G3A/G4/G5) 97-01<br>ZZR 400 (ZX 400 N1-N7) 93-99<br>ZR 550 B2-B6 91-98<br>ZZR 600 E1-E13 93-05<br>ZZR 600 (ZX 600 E6F) 06-07   | 240      | <b>MD4017</b>  | REAR        | S    | GPZ 750 E1/E2 Turbo 84-87<br>GPZ 750 R G2-G3 85-86<br>GPZ 900 R A1-A6 84-89<br>ZL 900 A1/A2 'Eliminator' 85-86<br>ZL 1000 A1 87<br>GPZ 1100 A1-A3 83-85   | 270      |
|                                      |             |      |   |          | <b>MD4018LS/RS</b>                                       |             |      | <b>USE MD4016LS/RS</b>  |          |
|                                      |             |      |   |          | <b>MD4019</b>  | REAR        | S    | GPZ 750 A1-A5 83-87<br>GPZ 1000 RX A1-A3 86-88  | 260      |
|                                      |             |      |   |          | <b>MD4020LS/RS</b>                                       |             |      | <b>USE MD4016LS/RS</b>  |          |
|                                      |             |      |   |          | <b>MD4021LS</b><br><b>MD4021RS</b>                       | FRONT       | S    | ZX 1000 B1-B3 (ZX10) 88-90  | 300      |

D = Dished Solid Original (We replace with floating rotor conversion unit) F = Floating Rotor S = Solid Rotor  
SF = Solid Flat Original Disc which we replace with fully floating unit - fits direct no mods required.















# STREETBIKE DISC BUYERS GUIDE

| DISC No.  | FRONT/ REAR | TYPE | MODELS   | DIA (MM) | DISC No.   | FRONT/ REAR | TYPE | MODELS  | DIA (MM) |
|---|-------------|------|--|----------|--|-------------|------|---|----------|
| MD4022LS<br>MD4022RS<br><br>MD4022C<br> | FRONT       | F    | ZXR 750 K1/K2/J1/J2/M1/M2 /L1-L3/P1-P7/N1/N2 91-03<br>ZX-9R B1-B4 94-97<br>ZX9R (ZX 900 F1/F2) 02-04<br>ZZR 1100 D1-D9 93-01<br>ZX12R (A1/A2/B1/B2/B3) 00-04<br>ZZR 1200 C1H/C2H 02-04<br>VN 1500 P1/P2 Mean Streak 02-04<br>VN 1600 B1/B2/B2H/B6F/B7F Mean Streak 04-07<br>SUZUKI VZ 1600 K4/K5 04-05 | 320      | MD4054LS<br><br>MD4054<br>7mm disc thickness   |             |      | USE MD4006<br><br>Z 1000 J1-J3 81-83<br>Z 1000 K1 'Ltd' 83<br>Z 1000 R2 83<br>GPZ 1100 B1-B2 82-83<br>Z 1100 A1-A3 81-83<br>Z 1100 D1/D2 'Spectre' 82-83<br>Z 1100 R1 'Lawson Replica' 84<br>VN 1500 A6 92<br>VN 1500 B2-B6 88-92 | 270      |
| MD4023<br>MD4023C   | REAR        | S    | ZX-6R F1-F3 95-97<br>ZX12R (A1/A2/B1/B2/B3/B4/B6F) 00-06   | 230      | MD4056   |             |      | USE MD4009  |          |
| MD4024  | REAR        | S    | GPZ 550 H1-H2 82-83  | 260      | MD4059LS/RS<br>   | FRONT       | D    | Z 650 C1/C2/C3/D2/D3 76-80  | 276      |
| MD4025LS/RS   |             |      | USE MD4012LS/RS  |          | MD4060LS/RS  |             |      | USE MD4006LS/RS   |          |
| MD4026LS<br>MD4026RS  | FRONT       | S    | GPX 600 R C1-C7 88-96  | 260      | MD4062<br>        | REAR        | D    | Z 650 C1-C2 77-78   | 276      |
| MD4027  | REAR        | S    | GPX 400 R (ZX 400 F1) 87<br>GPX 600 R C1-C7 88-96<br>ZR 1100 A1-A4 Zephyr 92-95<br>ZR 1100 B1 96-97<br>ZR 1100 B5 02   | 240      | MD4063<br>        | REAR        | D    | Z 650 C3 (D2/D3-SR) 78-80   | 276      |
| MD4028LS<br>MD4028RS  | FRONT       | S    | Z 400 C2/C3 (Z 400 F2) 85-87<br>GPZ 600 R A1-A5A 85-89<br>GPZ 750 A1-A5A 83-87<br>ZG 1000 A1-A7 86-93  | 270      | MD4064LS/RS<br>   | FRONT       | D    | Z 1000 A1-A4 77-80<br>Z 1000 H1 74  | 296      |
| MD4029  |             |      | USE MD4015   |          | MD4067LS<br>MD4067RS   | FRONT       | S    | ZN 700 A1/A2 'Ltd' 84-85  | 270      |
| MD4031LS  |             |      | USE MD4002LS   |          | MD4068   | REAR        | S    | ZN 700 A1/A2 'Ltd' 84-85  | 260      |
| MD4032  | REAR        | S    | GPX 250 R (EX 250 E) 86  | 240      | MD4069LS/RS<br> | FRONT       | D    | Z 900 Z1A/Z1B 74-76   | 296      |
| MD4033LS/RS   |             |      | USE MD4028LS/RS  |          | MD4071LS<br>MD4071RS   | FRONT       | S    | GPX 750 R F1-F3 87-89   | 270      |
| MD4034  |             |      | USE MD4019   |          | MD4075   |             |      | USE MD4077  |          |
| MD4035LS/RS   |             |      | USE MD4016LS/RS  |          | MD4076LS/RS<br> | FRONT       | D    | Z 1000 D1-D3 (ZIR) 78-79  | 298      |
| MD4036  |             |      | USE MD4017   |          | MD4077<br>      | REAR        | D    | Z 1000 D1-D3 (ZIR) 78-79<br>Z 1000 A1-A4 77-80<br>Z 1000 H1 74  | 290      |
| MD4038LS<br>MD4038RS  | FRONT       | S    | Z 1000 J3 83<br>Z 1000 R2 83<br>GPZ 1100 B2 83<br>Z 1100 R1 'Lawson Replica' 84  | 280      | MD4078LS/RS<br> | FRONT       | D    | Z 1000 ST E1-E2 79-82   | 286      |
| MD4040LS  | FRONT       | S    | AR 50 A1/C2-C10 81-97<br>AR 80 A1/C1-C8 81-91  | 210      | MD4082   | REAR        | S    | ZG 1000 A1-A7 86-93<br>ZG 1000 A9-A18 94-03   | 280      |
| MD4041RS  | FRONT       | S    | GPX 250 R (EX250 F) 87<br>GPX 250 R 88-95  | 260      | MD4085   | REAR        | S    | VN 900 A6F Classic 06<br>VN 900 C7F Custom (Cast wheel) 07<br>VN 900 B7F Classic (Spoke wheel) 07   | 270      |
| MD4042  | REAR        | S    | GPX 250 R 88-95<br>GPX 250 R (EX 250 F/G) 87-88  | 230      | MD4089LS/RS<br> | FRONT       | D    | Z 1300 A1-A5 79-83<br>ZG 1300 A1-A3 84-86   | 299      |
| MD4043LS<br>MD4043RS  | FRONT       | F    | Z 750 Y1 Ltd 82  | 260      | MD4090   | REAR        | S    | Z 1000 ST E1-E2 79-82<br>Z 1300 A1-A5 79-83<br>ZG 1300 A1-A3 84-86  | 290      |
| MD4047LS<br>MD4047RS<br>   | FRONT       | D    | Z 400 J1 80<br>Z 440 A2 'Ltd' 79<br>Z 440 D4 'Ltd' 82<br>Z 500 B1-B2 79-80<br>Z 550 A1 80  | 278      | MD4093LS   |             |      | USE MD4124LS  |          |
| MD4048LS  |             |      | USE MD4006LS   |          | MD4094LS<br>    | FRONT       | SF   | VN 1500 B2-B6 88-92   | 300      |
| MD4051<br>MD4051C   | REAR        | S    | ZXR 250 A1/A2/B1/B2 89-90<br>ZR 250 A1-A5 91-95<br>ZR 250 B6 Badius-II 02<br>ZXR 250 C1-C3/D1 91-95<br>GPZ 500 'S' (EX 500 D1-D7) 94-01<br>GPZ 500 S (EX 500 E1-E10) 94-04   | 230      | MD4095LS/RS<br> | FRONT       | F    | KR-1 (KR 250 B2) 89   | 280      |
| MD4052LS<br>   | FRONT       | D    | Z 650 B1-B3 79-81<br>Z 650 F1 79<br>Z 900 A4 77  | 296      |  |             |      |   |          |

D = Dished Solid Original (We replace with floating rotor conversion unit) F = Floating Rotor S = Solid Rotor  
SF = Solid Flat Original Disc which we replace with fully floating unit - fits direct no mods required.







# STREETBIKE DISC BUYERS GUIDE

| DISC No.   | FRONT/ REAR | TYPE | MODELS  | DIA (MM) | DISC No.          | FRONT/ REAR | TYPE | MODELS  | DIA (MM) |
|--|-------------|------|---|----------|-------------------|-------------|------|---|----------|
| MD4096   | REAR        | S    | KR-1 (KR 250 B2) 89<br>KR-1S (KR 250 C2-C3) 90-92   | 210      | MD4138<br>MD4138C | REAR        | S    | ZX6R (ZX 600 G1/G2/J1/J2) 98-01<br>ZX6R (ZX 636 A1P/B1/B2) 636cc 02-04<br>ZX-6R (ZX 636 C1/C6F) 05-06<br>ZX6R (ZX 600 P7F) 07<br>ZX6RR (ZX 600 K1/M1) 03-04<br>ZX-6RR (ZX 600 N1/N6F) 05-06<br>ER-6N (ER 650 A6F/A7F) 06-07<br>ER-6F (EX 650 A6F/A7F) 06<br>ER-6F (ABS Model) (EX 650 B6F/B7F) 06-07<br>ER-6N (ABS Model) ER 650 B6F 06-07<br>KLE 650 A7F Versys 07<br>KLE 650 B7F Versys ABS 07<br>Z 750 (ZR 750 J1/J2/J6F) 04-06<br>Z 750 S (ZR 750 K1/K6F) 05-06<br>ZX9R (ZX 900 C1/C2/E1/E2) 98-01<br>ZX9R (ZX 900 F1/F2) 02-04<br>ZX10R (ZX 1000 C1/C2/D6F) 04-06<br>Z 1000 (ZR 1000 A1/A2/A3/A6F) 03-06 | 220      |
| MD4099LS   | FRONT       | S    | AR 125 A1-A7/B1-B8 82-94<br>ER 250 B1-B3 83-88<br>GPZ 550 H1-H2 82-83   | 260      |                   |             |      |   |          |
| MD4105LS<br>MD4105RS   | FRONT       | S    | KH 100 G5-G8 (EX) 84-87<br>KH 125 L1 (EX) 84<br>GPZ 305 A1/B1-B10 83-96   | 240      |                   |             |      |   |          |
| MD4108LS<br>MD4108RS   | FRONT       | S    | ZR 400 A1/B1 83-84<br>ZR 550 A1-A2 (Z 550 F) 83-84  | 270      |                   |             |      |   |          |
| MD4115LS   |             |      | USE MD4124LS  |          |                   |             |      |   |          |
| MD4116LS   | FRONT       | S    | KH 100 G2-G4 81-83  | 240      |                   |             |      |   |          |
| MD4117   | REAR        | S    | ZZR 250 (EX 250 H1-H13) 90-03   | 220      |                   |             |      |   |          |
| MD4122LS<br>MD4122RS   |             |      | USE MD4008LS/RS   |          |                   |             |      |   |          |
| MD4123<br>  | REAR        | D    | Z 500 B1-B2 79-80   | 270      |                   |             |      |   |          |
| MD4124LS<br>  | FRONT       | F    | EN 500 B1-B2/C1-C9 94-04<br>VN 800 A1-A3 95-99<br>VN 1500 C1-C2 94-95<br>VN 1500 A6 92<br>VN 1500 N1/N2/N3 00-02  | 299      |                   |             |      |   |          |
| MD4125LS   | FRONT       | S    | VN 800 B1-B10/B6F Classic 96-06<br>VN 800 C1/C2/E1/E2/E3 Drifter 99-04<br>VN 1500 J1/J2/R1/R2/R3 /N1/N2/N3 99-04  | 300      |                   |             |      |   |          |
| MD4126LS<br>MD4126RS   |             |      | USE MD4038LS/RS   |          |                   |             |      |   |          |
| MD4127   |             |      | USE MD4054  |          |                   |             |      |   |          |
| MD4128   | REAR        | S    | VN 1500 C1-C2 94-95<br>VN 1500 D1/D2/E1/F2 96-99  | 270      |                   |             |      |   |          |
| MD4129LS<br>MD4129RS   |             |      | USE MD4008LS/RS   |          |                   |             |      |   |          |
| MD4130   | REAR        | S    | GPZ 1100 E1/E2/F1 95-98   | 250      |                   |             |      |   |          |
| MD4131LS<br>  | FRONT       | F    | VN 1500 D1/D2/E1/E2 96-99   | 299      |                   |             |      |   |          |
| MD4132RS<br>  | FRONT       | F    | GPZ 1100 F1 96-98   | 300      |                   |             |      |   |          |
| MD4133<br>MD4133C  | REAR        | S    | ZRX 1100 C1/C2/C3/C4 97-00<br>ZRX 1200 A1-A5/A6F 01-07<br>ZRX 1200 B1-B3 01-03<br>ZZR 1200 C1H/C2H 02-04  | 250      |                   |             |      |   |          |
| MD4134LS/RS<br>   | FRONT       | F    | ZX-4 (ZX 400 G1/G1A/G1B) 88   | 300      |                   |             |      |   |          |
| MD4135LS<br>MD4135RS   | FRONT       | S    | GPZ 400 R (ZX 400 D/D3/D3A) 85-87<br>ZL 400 B 'Eliminator 400 SE' 88<br>FX 400 R (ZX 400 E1-E3) 86-88   | 270      |                   |             |      |   |          |
| MD4136LS/RS<br><br>MD4136C<br> | FRONT       | F    | ZX6R (ZX 600 G1/G2/J1/J2) 98-01<br>ZZX6R (ZX 636 A1P) 636cc 02<br>ZX9R (ZX 900 C1/C2) 98-99   | 300      |                   |             |      |   |          |
| MD4137RS   | FRONT       | S    | BN 125 A1-A5/A6F/A7F Eliminator 98-07   | 260      |                   |             |      |   |          |
| MD4140LS<br>MD4140RS   | FRONT       | S    | GPX 400 R (ZX 400 F1) 87  | 270      |                   |             |      |   |          |
| MD4141LS/RS<br>MD4141C<br>  | FRONT       | F    | ZR-7 (ZR 750 F1/F3/F5) 99-04<br>ZR-7S (ZR 750 H1/H3) 01-04<br>ZZR 600 D1-D3 90-93<br>Z 750 S K1/K6F/J1/J2/J6F Naked   | 300      |                   |             |      |   |          |
| MD4142   | REAR        | S    | ZR-7 (ZR 750 F1/F3/F5) 99-04<br>ZR-7S ZR 750 H1/H3 01-04  | 240      |                   |             |      |   |          |
| MD4143LS<br>MD4143RS   | FRONT       | S    | GPZ 400 R D4 88   | 280      |                   |             |      |   |          |
| MD4144LS<br>MD4144RS   | FRONT       | S    | GPZ 500 S (EX 500 B1-B5) 88-93<br>GPZ 500 S (EX 500 E1-E10) 94-04   | 270      |                   |             |      |   |          |
| MD4146   | REAR        | S    | VN 1500 P1/P2 03-04<br>VN 1600 A1/A2/A3/A6F/B1 03-07<br>VN 1600 B2H/B6F/B7F (Mean Streak) 05-07<br>VN 1600 D1H/D6F Classic Tourer 05-06<br><b>SUZUKI</b><br>VZ 1600 K4 Marauder 04<br>VZ 1600 K5 (M 1600 Intruder) 05 | 300      |                   |             |      |   |          |
| MD4147   | REAR        | S    | VN 1500 G1/G2/L1/L2/L3/L4 98-03   | 320      |                   |             |      |   |          |
| MD4148   | FRONT       | S    | VN 800 C1/C2/E1/E2/E3 99-04<br>VN 1500 J1/J2/R1/R2/R3 /N1/N2/N3 99-04   | 270      |                   |             |      |   |          |
| MD4149LS/RS<br>   | FRONT       | F    | ZXR 250 C1/C2/C3/D1 91-95   | 300      |                   |             |      |   |          |
| MD4150LS<br>MD4150RS   | FRONT       | S    | VN 1500 G1/G2 98-99<br>VN 1500 L1/L2/L3/L4 00-03  | 280      |                   |             |      |   |          |
| MD4151LS/RS<br><br>MD4151C<br> | FRONT       | F    | ZX6RR (ZX 600 K1/M1) 03-04<br>ZX6R (ZX 636 B1/B2) 03-04   | 280      |                   |             |      |   |          |
| MD4152C<br>Contour disc<br>   | FRONT       | F    | ZX-6RR (ZX 600 N1/N6F) 05-06<br>ZX-6R (ZX 636 C1/C6F) 05-06<br>ZX-6R (ZX 600 P7F) 07<br>ZX10R (ZX 1000 C1/C2/D6F/D7F) 04-07<br>Z 1000 (ZR 1000 B7F) 07<br>Z 1000 ABS (ZR 1000 C7F) 07                                 | 300      |                   |             |      |   |          |
| MD4153LS/RS<br>MD4153C<br>  | FRONT       | F    | ZZR 600 E1-E13 93-05<br>ZZR 600 (ZX 600 E6F) 06-07  | 300      |                   |             |      |   |          |
| MD4154LS<br>MD4154RS<br>MD4154C<br>   | FRONT       | F    | Z 1000 (ZR 1000 A1-A3/A6F) 03-06<br>ZX12R B3/B4/B6F 04-06   | 300      |                   |             |      |   |          |

DISC BUYERS GUIDE

D = Dished Solid Original (We replace with floating rotor conversion unit) F = Floating Rotor S = Solid Rotor  
SF = Solid Flat Original Disc which we replace with fully floating unit - fits direct no mods required.

# STREETBIKE DISC BUYERS GUIDE

| DISC No.   | FRONT/ REAR | TYPE | MODELS  | DIA (MM) | DISC No. | FRONT/ REAR | TYPE | MODELS | DIA (MM) |
|--|-------------|------|---|----------|----------|-------------|------|--------|----------|
| MD4155C<br>                     | FRONT       | F    | GTR 1400 (ZG 1400 A8F) 07<br>ZZR 1400 (ZX 1400 A6F/A7F) 06-07<br>ZZR 1400 ABS (ZX 1400 B7F) 07  | 310      |          |             |      |        |          |
| MD4156C<br>                     | FRONT       | F    | ER-6F (EX 650 A6F/A7F) 06-07<br>ER-6N (ER 650 A6F/A7F) 06-07  | 300      |          |             |      |        |          |
| MD4156AC<br>(With ABS ring)<br> | FRONT       | F    | ER-6F (ABS Model) (EX 650 B6F/B7F) 06-07<br>ER-6N (ABS Model) (ER 650 B6F/B7F) 06-07<br>KLE 650 B7F Versys ABS 07<br>Z 750 ABS (ZR 750 M7F) 07  | 300      |          |             |      |        |          |
| MD4157C  | REAR        | S    | Z 750 (ZR 750 L7F) 07<br>Z 750 ABS (ZR 750 M7F) 07<br>Z 1000 (ZR 1000 B7F) 07<br>Z 1000 ABS (ZR 1000 C7F) 07<br>GTR 1400 (ZG 1400 A8F) 07<br>ZZR 1400 (ZX 1400 A6F) 06<br>ZZR 1400 ABS (ZX 1400 B7F) 07 | 250      |          |             |      |        |          |
| MD4158LS<br>MD4158RS   | FRONT       | S    | VN 900 A6F Classic 06<br>VN 900 C7F Custom (Cast wheel) 07<br>VN 900 B7F Classic (Spoke wheel) 07<br>VN 1600 A1/A2/A3/A6F 03-07<br>VN 1600 D1H/D6F 05-07<br>VN 2000 A1/A2/A6F 04-07                     | 300      |          |             |      |        |          |
| MD4159C<br>                     | FRONT       | F    | KLE 650 A7F Versys 07<br>Z 750 (ZR 750 L7F) 07  | 300      |          |             |      |        |          |
|  |             |      |   |          |          |             |      |        |          |

D = Dished Solid Original (We replace with floating rotor conversion unit) F = Floating Rotor S = Solid Rotor  
SF = Solid Flat Original Disc which we replace with fully floating unit - fits direct no mods required.

370 Part numbers, illustrations and format of this catalogue are covered by COPYRIGHT. Imitation or copy without our written consent will result in prosecution.



# OFF ROAD DISC BUYERS GUIDE

| DISC No.   | FRONT/ REAR | TYPE | MODELS  | DIA (MM) | DISC No.  | FRONT/ REAR | TYPE | MODELS  | DIA (MM) |
|--|-------------|------|---|----------|---|-------------|------|---|----------|
| <b>MD6017D</b><br><b>OS6017</b><br><b>OS6017E</b><br><b>MD6017C</b><br><b>Contd.</b> | FRONT       | S    | <b>SUZUKI</b><br>RMX 250 P/R/S/T/V/W 94-98<br>RMX 250 ST/SV/SW/SX (SJ14A) 96-99<br>RMX 250 SN/SR/SS 95-97<br>WR 250 FW 07<br>YZ 250 FW 07<br>DR 350 SEW/SEX 98-99<br>DR-Z 400 EY/Y/SY/EK1/K1/SEK1/EK2<br>/SEK2/K2/K3/SK2/EK2/K2/SK3/EK3<br>/K3/SK4/EK4/K4/SK5/EK5/K6/EK6<br>/SK6/SK7/EK7/K7 00-07<br><b>KAWASAKI</b><br>KLX 400 R (KLX 400 B1/B2) 03-04<br><b>YAMAHA</b><br>YZ 125/250 N/P/R/S/T/V/W 01-09<br>WR 250 FP/FR/FS/FT/FV 02-06<br>YZ 250 FN/FP/FR/FS/FT/FV 01-06<br>WR 400 FN 01<br>WR 426 FN/FP 01-02<br>YZ 426 FN/FP 01-02<br>YZ 450 FR/FS/FT/FV/FW 03-07<br>WR 450 FR/FS/FT/FV/FW 03-07 | 250      | <b>MD6032D</b><br><b>OS6032</b><br><b>OS6032E</b><br><b>MD6032C</b> | FRONT       | S    | <b>KTM</b><br>MX 125 92-93<br>SX 125 94-07<br>EXC/EGS 125 94<br>EXC 125 95-06<br>EXE 125 00<br>EXC/EGS 200 98-99<br>EXC 200 04-07<br>MX 250 92-93<br>SX 250 94-05<br>SXF 250 06-07<br>EXC/EGS 250 94<br>EXC 250 95-07<br>EXC-F 250 06-07<br>EXC 250 Racing 06<br>EXC 300 00-07<br>EXC 350 94-95<br>SX 360 96-97<br>EXC 360 96-97<br>SX 380 98-03<br>EXC 380 98-03<br>SC 400 96-99<br>SX 400 00-02<br>EXC/EGS 400 (USD) 00-02<br>EXC 400 Racing (USD) 00<br>EXC 400 Racing 06-07<br>SX 440 94-95<br>EXC 440 94-95<br>SX-F 450 03-07<br>EXC 450 03-05<br>EXC 450 Racing 06-07<br>SMR 450 05<br>SXF 505 07<br>SX 520 01-03<br>EXC 520 01-03<br>EXC 525 03-05<br>XC 525 Racing 06-07<br>MXC 525 03-04<br>SX 525 03-06<br>XC 525 Racing 06<br>MXC 550 96<br>SX/EXC/EGS 620 94-95<br>EGS-E 620 Adventure/Rallye 99<br>SX 620 96-99<br>SC 620 Supercompetition 96-00<br>SXC 625 03-06<br>LC4 625 SC Supercompetition 02<br><b>BENELLI</b><br>BX 450 07<br><b>HUSABERG</b><br>All MX/Enduro Models<br>Brembo 2 piston caliper 260Ø F Disc | 260      |
| <b>MD6018D</b><br><b>MD6018C</b>   | FRONT       | S    | RM 80 XG/XH/XJ/XK/XL/XM/XN<br>/XP/XR/XS/T/V/W/X/Y/K1 86-01<br>RM 85 K2/LK2/K3/LK3/LK4/K4 02-04  | 200      |   |             |      |   |          |
| <b>MD6019D</b>   |             |      | <b>USE MD6025D</b>  |          |   |             |      |   |          |
| <b>MD6020D</b>   | FRONT       | S    | LT 250 RH/RJ/RK/RL 87-90  | 160      |   |             |      |   |          |
| <b>MD6021D</b>   | REAR        | S    | LT 250 RH/RJ/RK/RL 87-90  | 220      |   |             |      |   |          |
| <b>MD6022D</b>   | FRONT       | S    | LT 500 RL 90  | 170      |   |             |      |   |          |
| <b>MD6023D</b>   | REAR        | S    | LT 500 RL 90  | 240      |   |             |      |   |          |
| <b>MD6024D</b><br><b>MD6024C</b>   | REAR        | S    | KX 125 G1/H1/H2/J1/J2/<br>K1-K5/L1/L2/L3 89-01<br>KDX 200 E1-E6 89-94<br>KX 250 G1/H1/H2/J1/J2<br>K1-K5/L1/L2/L3 89-01<br>KX 500 E1-E16 89-04   | 220      |   |             |      |   |          |
| <b>MD6025D</b><br><b>MD6025C</b>   | REAR        | S    | KX 80 L1/L2/N2/L3/N3<br>R1/T1 88-91<br>KX 80 R2-R7/T2-T6/W1-W3 92-00<br>KX 100 A1/A2/B1-B7/C1-C3 89-00<br><b>SUZUKI</b><br>RM 80 XL/XM/XN/XP/<br>XR/XS/T/V/W/X/Y/K1 90-01<br>RM 85 K2/LK2/K3/LK3/LK4/K4 02-04   | 185      |   |             |      |   |          |
| <b>MD6026D</b>   | FRONT       | S    | KX 80 R2-R7/T2-T6/W1-W3 92-00<br>KX 85/85 II A1/B1 01<br>KX 100 B2-B7/C1/C2/C3 91-00  | 220      | <b>MD6033D</b>  |             |      | <b>USE MD6035</b>   |          |
| <b>MD6027D</b>   | FRONT       | S    | KX 80 E2/E3/G1/G2/J1/J2 84-87<br>KX 80 L1-L3/N2/N3/R1/T1 88-91<br>KX 100 A1/A2/B1 89-91   | 200      | <b>MD6034D</b>  | FRONT       | S    | <b>KTM</b> EXC 125 89<br>D-XC/E-XC/E-GS 125 90-93<br>EXC/EGS 250 89<br>DXC/EXC 250 90<br>DXC/EXC/EGS 250 91<br>DXC/EXC/EGS 350 90-91<br>EXC 350 89<br>LC-4 MX/EXC 500 89<br>LC-4 MX 500 (Brembo) 90-91<br>LC-4 EXC 500 (Grimeca) 90-91<br>LC-4 MX/EXC 600 89<br>LC-4 EXC 600 90-93  | 240      |
| <b>MD6028D</b><br><b>OS6028</b><br><b>OS6028E</b><br><b>MD6028C</b>                  | FRONT       | S    | YZ 125 D/E/F/G/H/J/K/L/M 92-00<br>YZ 250 D/E/F/G/H/J/K/L/M 92-00<br>WR 250 ZB/ZD/ZE/ZF/ZG/ZH/ZJ/ZK 91-98<br>WR 400 FL/FM 99-00<br>YZ 400 FK/FL/<br>WR 400 FK/FL/FM 98-00<br>YZ 426 FM 00  | 245      | <b>MD6035D</b><br><b>MD6035C</b>                                    | REAR        | S    | <b>KTM</b><br>SX 125 94-07<br>EXC/EGS 125 94<br>EXC 125 95-07<br>EXE 125 00<br>SM 125 Supermoto 00<br>EXC/EGS 200 98-03<br>EXC 200 04-07<br>D-XC/E-XC/T-XC/E-GS 250 92-93<br>SX 250 94-07<br>EXC/EGS 250 94<br>EXC-F 250 06-07<br>EXC 250 95-07<br>EXC 250 Racing 06<br>SXF 250 06-07<br>EXC 300 00-07<br>EXC 350 LC4 94-95<br>SX/EXC 360 96-97   | 220      |
| <b>MD6029D</b>   | FRONT       | S    | YZ 80 S/T/U/W 86-89   | 190      |   |             |      |   |          |
| <b>MD6030D</b><br><b>MD6030C</b><br><b>OSS6030C</b><br><b>OSY6030C</b>               | FRONT       | S    | <b>YAMAHA</b><br>YZ 80 E/F/LWF/LWG/G/LWH/<br>H/LWJ/J/LWK/K/L/LWL/<br>M/LWM/N/LWN 93-01<br>YZ 85 P/LWP/R/LWR/S/LWS<br>T/LWT/V/LWV 02-06<br><b>SUZUKI</b><br>RM 85 K5/LK5/K6/LK6/K7/LK7 05-07   | 220      |   |             |      |   |          |
| <b>MD6031D</b><br><b>MD6031C</b>   | REAR        | S    | YZ 80 E/F/LWF/LWG/G/LWH<br>/H/LWJ/J/LWK/K/L/LWL<br>M/LWM/N/LWN 93-01<br>YZ 85 P/LWP/R/LWR/S/LWS<br>T/LWT/V/LWV 02-06  | 190      |   |             |      |   |          |



★ = Note - Twin disc front - order D suffix for LHS - DR suffix for RHS

# OFF ROAD DISC BUYERS GUIDE

| DISC No.  | FRONT/ REAR | TYPE                               | MODELS                               | DIA (MM) | DISC No.   | FRONT/ REAR | TYPE | MODELS  | DIA (MM) |
|---|-------------|------------------------------------|--------------------------------------|----------|--|-------------|------|---|----------|
| <b>MD6035D</b><br><b>MD6035C</b><br><b>Contd.</b> | REAR        | S                                  | <b>KTM</b>                           | 220      | <b>MD6040D</b>                                     | FRONT       | S    | DR 250 SL/SM/SN/SEP/SER/SES 90-95                     | 250      |
|   |             |                                    | SX 380 98-03                         |          |  |             |      | DR 350 SL/SM/SN/SP/SER/SES /SET/SEV 91-97             |          |
|   |             |                                    | EXC 380 98-99                        |          |  |             |      |   |          |
|   |             |                                    | SC 400 96-99                         |          |  |             |      |   |          |
|   |             |                                    | EGS 400/EGS-E/LSE (LC4 Enduro) 96-99 |          |  |             |      |   |          |
|   |             |                                    | SX 400 00-02                         |          |  |             |      |   |          |
|   |             |                                    | EXC/EGS 400 (USD) 00-02              |          |  |             |      |   |          |
|   |             |                                    | EXC 400 Racing 00/06-07              |          |  |             |      |   |          |
|   |             |                                    | LC4-E 400 Enduro 00-01               |          |  |             |      |   |          |
|   |             |                                    | SX/EXC 440 94-95                     |          |  |             |      |   |          |
|   |             |                                    | SX-F 450 03-07                       |          |  |             |      |   |          |
|   |             |                                    | EXC 450 03-05                        |          |  |             |      |   |          |
|   |             |                                    | EXC 450 Racing 06-07                 |          |  |             |      |   |          |
|   |             |                                    | SMR 450 04-07                        |          |  |             |      |   |          |
|   |             |                                    | SX-F 55 07                           |          |  |             |      |   |          |
|   |             |                                    | EXC 525 03                           |          |  |             |      |   |          |
|   |             |                                    | SX 525 03-06                         |          |  |             |      |   |          |
|   |             |                                    | LC-4 MX 500 90-91                    |          |  |             |      |   |          |
|   |             |                                    | LC-4 EXC 500 90-91                   |          |  |             |      |   |          |
|   |             |                                    | EXC 520 01-03                        |          |  |             |      |   |          |
|   |             |                                    | SX 520 01-03                         |          |  |             |      |   |          |
|   |             |                                    | EXC 525 04-05                        |          |  |             |      |   |          |
|   |             |                                    | EXC 525 Racing 06-07                 |          |  |             |      |   |          |
|   |             |                                    | MXC 525 03-04                        |          |  |             |      |   |          |
|   |             |                                    | SMR 525 05                           |          |  |             |      |   |          |
|   |             |                                    | MXC 550 96                           |          |  |             |      |   |          |
|   |             |                                    | SMR 560 Supermoto 06-07              |          |  |             |      |   |          |
|   |             |                                    | LC4 MX 600 90-91                     |          |  |             |      |   |          |
|   |             |                                    | LC4 EXC 600 90-93                    |          |  |             |      |   |          |
|   |             |                                    | SX EXC/EGS 620 95                    |          |  |             |      |   |          |
|   |             |                                    | SX 620 96-99                         |          |  |             |      |   |          |
|   |             |                                    | SC 620 Supercompetition 96-00        |          |  |             |      |   |          |
|   |             |                                    | EGS/EGS-E/LSE 620 Enduro 96-99       |          |  |             |      |   |          |
| EGS-E 620 Adventure/Rallye 99                     |             |                                    |                                      |          |  |             |      |   |          |
| LC4 620 SC Supermoto 00                           |             |                                    |                                      |          |  |             |      |   |          |
| LC4 625 SC Supermoto 02                           |             |                                    |                                      |          |  |             |      |   |          |
| LC4 625 SC Supercompetition 02                    |             |                                    |                                      |          |  |             |      |   |          |
| SMC 625 05  |             |                                    |                                      |          |  |             |      |   |          |
| SXC 625 03-04                                     |             |                                    |                                      |          |  |             |      |   |          |
| LC4-E 640 Enduro 00-04                            |             |                                    |                                      |          |  |             |      |   |          |
| LC4-E 640 Supermoto 00-04                         |             |                                    |                                      |          |  |             |      |   |          |
| LC4 640 Adventure R 00                            |             |                                    |                                      |          |  |             |      |   |          |
| LC4 640 Adventure 01-05                           |             |                                    |                                      |          |  |             |      |   |          |
| 640 LC4 Adventure 03-07                           |             |                                    |                                      |          |  |             |      |   |          |
| Duke II 640 01-06                                 |             |                                    |                                      |          |  |             |      |   |          |
| SMC 660 Supermoto 03-04                           |             |                                    |                                      |          |  |             |      |   |          |
| <b>BENELLI</b>                                    |             |                                    |                                      |          |  |             |      |   |          |
| BX 450 07   |             |                                    |                                      |          |  |             |      |   |          |
| <b>HUSABERG</b>                                   |             |                                    |                                      |          |  |             |      |   |          |
| All MX/Enduro Models                              |             |                                    |                                      |          |  |             |      |   |          |
| Brembo 2 piston caliper 220Ø F Disc               |             |                                    |                                      |          |  |             |      |   |          |
| <b>MD6036D</b>                                    | FRONT       | S                                  | KX 125 D1/E1/E2/F1 85-88             | 250      | <b>MD6054D</b>                                     | FRONT       | S    | YFS 200 R/S/T/V 03-06                                 | 161      |
|   |             |                                    | KDX 200 C1-C3 86-88                  |          |  |             |      | YFM 250 XN/XP/XR/XS 01-04                             |          |
|   |             |                                    | KDX 200 E1-E4 89-92                  |          |  |             |      | YFM 250 BT/BV Bruin 05-06                             |          |
| KDX 200 SR (DX 200 G)                             |             | YFM 250 BW Big Bear 07             |                                      |          |  |             |      |   |          |
| KX 250 D1-D2/E1/F1 85-88                          |             | YFM 350 XD/XE/XF/XG/XH/XJ 92-04    |                                      |          |  |             |      |   |          |
| KX 500 B1-B2/C1/D1 85-88                          |             | YFM 350 S/T/V/R-WV/RW Raptor 04-07 |                                      |          |  |             |      |   |          |
| <b>MD6037D</b><br><b>OS6037</b><br><b>MD6037C</b> | FRONT       | S                                  | CR 125 RS/RT/RV/RW/RX/R1/R7 95-07    | 240      | <b>MD6055D</b>                                     | REAR        | S    | YFM 350 XD/XE/XF/XG/XH/XJ /XK/XL/XM/XN/XP/XR/XS 92-04 | 245      |
|   |             |                                    | CR 250 RS/RT/RV/RW/RX/R1/R7 95-07    |          |  |             |      |   |          |
|   |             |                                    | CRE 250 X                            |          |  |             |      |   |          |
|   |             |                                    | CRF 250 R4/R5/R6/R7 04-07            |          |  |             |      |   |          |
|   |             |                                    | CRF 250 X4/X5/X6/X7 04-07            |          |  |             |      |   |          |
|   |             |                                    | CRE F 290 X 07                       |          |  |             |      |   |          |
|   |             |                                    | CRE 450 X                            |          |  |             |      |   |          |
|   |             |                                    | CRF 450 R2/R3/R4/R5/R6/R7 02-07      |          |  |             |      |   |          |
|   |             |                                    | CRF 450 X5/X6/X7 05-07               |          |  |             |      |   |          |
|   |             |                                    | CRE F 490 X 07                       |          |  |             |      |   |          |
| CR 500 RS/RT/RV/RW/RX/R1 95-01                    |             |                                    |                                      |          |  |             |      |   |          |
| <b>MD6038D</b>                                    | REAR        | S                                  | TS 125 RK/RL/RM/RN/ RP/RR 90-96      | 220      | <b>MD6056D</b>                                     |             |      | <b>USE MD6008D</b>                                    |          |
|   |             |                                    | TS 200 RK/RL/RM/RN/RP/RR 89-94       |          |  |             |      |   |          |
|   |             |                                    | DR 250 SL/SM/SN/SEP/SER/SES 90-95    |          |  |             |      |   |          |
| DR 350 SL/SM/SN/SP/SER /SES 91-95                 |             |                                    |                                      |          |  |             |      |   |          |
| <b>MD6039D</b>                                    | FRONT       | S                                  | DT 125 R 88-03                       | 230      | <b>MD6057D</b>                                     | FRONT       | S    | KMX 200 A2/A3 89-92                                   | 240      |
|   |             |                                    | DT 125 RE 04-07                      |          |  |             |      | KLR 250 D2-D22 84-05                                  |          |
|   |             |                                    | YZ 125/250 U 88                      |          |  |             |      |   |          |
|   |             |                                    | YZ 490 U 88                          |          |  |             |      |   |          |
|   |             |                                    | TT 600 W (59X/2JT/3SW1) 89-92        |          |  |             |      |   |          |
| <b>MD6039D</b>                                    | FRONT       | S                                  | WR 200 D/E/F 92-94                   | 245      | <b>MD6058D</b><br><b>MD6058C</b><br><b>OS6058C</b> | FRONT       | S    | CR 80 RT/RBT/RBV/RV/RBW /RW/RX/RBX/R1/RB1 96-02       | 220      |
|   |             |                                    | DT 200 WR 92-93                      |          |  |             |      | R21/RB2 96-02   |          |
|   |             |                                    | DT 230 Lanza (LTP1/2) 97-98          |          |  |             |      | CR 85 R/R2 03-07                                      |          |
|   |             |                                    | TT 250 R (4GY) Raid/4MR2 96          |          |  |             |      | CR 85 R3/RB3/R4/RB4/R5/RB5 /R6/RB6/R7/RB7 03-07       |          |
|   |             |                                    | TT-R 250 RLRM/RN/RP/RR 99-04         |          |  |             |      | CRF 150 RB7/R7 07                                     |          |
|   |             |                                    |                                      |          |  |             |      |   |          |
|   |             |                                    |                                      |          |  |             |      |   |          |
|   |             |                                    |                                      |          |  |             |      |   |          |
|   |             |                                    |                                      |          |  |             |      |   |          |
|   |             |                                    |                                      |          |  |             |      |   |          |
|   |             |                                    |                                      |          |  |             |      |   |          |

\* = Note - Twin disc front - order D suffix for LHS - DR suffix for RHS

# OFF ROAD DISC BUYERS GUIDE

| DISC No.  | FRONT/ REAR                       | TYPE  | MODELS  | DIA (MM)                                      | DISC No.   | FRONT/ REAR | TYPE                                   | MODELS  | DIA (MM) |       |   |  |     |
|---|-----------------------------------|-------|---|---|--|-------------|--|---|----------|-------|---|--|-----|
| MD6067D   | FRONT                             | S     | DT 125 LC 86-87                                   | 220   | MD6086D  | FRONT       | F                                      | KLX 650 C1-C3 93-97   | 290      |       |   |  |     |
|   |                                   |       | TW 125 99-04                                      |   |  |             |  |  |          |       |   |  |     |
|   |                                   |       | YZ 125/250 S/T 86-87                              |   |  |             |  |   |          |       |   |  |     |
|   |                                   |       | DT 200 (2LR) 87                                   |   |  |             |  |   |          |       |   |  |     |
|   |                                   |       | TW 200 (2JL/4CS1/2/3/4/5/6/5LB1/2) 01-02          |   |  |             |  |   |          |       |   |  |     |
|   |                                   |       | ST 225 (5BT) Bronco 97                            |   |  |             |  |   |          |       |   |  |     |
|   |                                   |       | T 225 E (5VC1/2) 03                               |   |  |             |  |   |          |       |   |  |     |
|   |                                   |       | XT 225 Serrow (4JG) MK1-2                         |   |  |             |  |   |          |       |   |  |     |
|   |                                   |       | XT 225 W (4JG106 Serrow) 93-98                    |   |  |             |  |   |          |       |   |  |     |
|   |                                   |       | XT 225 (2LN) Serrow (1KH 020101-) 86-87           |   |  |             |  |   |          |       |   |  |     |
| XT 225 (3RW1-5 Serrow) (1KH 034101-13200) 89-93 | MD6087D                           | FRONT | S   | CR 125 RE/RF/RG/RH/RJ 84-88                   |  |             |  |   |          |       |   |  |     |
| XG 250 Tricker (5TX1) 04-06                     |                                   |       |   | MTX 125 RWE/RWF/RWH/RWL 85-95                 |  |             |  |   |          |       |   |  |     |
| YZ 490 N/S/T 85-87                              |                                   |       |   | Sauel 125                                     |  |             |  |   |          |       |   |  |     |
| KT Karion 125 02-06                             |                                   |       |   | XL 125 RF/RH 85-86                            |  |             |  |   |          |       |   |  |     |
|   |                                   |       |   | MTX 200 RWF 85                                |  |             |  |   |          |       |   |  |     |
|   |                                   |       |   | CR 250 RE/RF/RG/RH/RJ 84-88                   |  |             |  |   |          |       |   |  |     |
|   |                                   |       |   | CRM 250 R (RK) MK1 MD24 (10001-1008385) 89-90 |  |             |  |   |          |       |   |  |     |
|   |                                   |       |   | XR 250 RG/RH/RJ/RK/RL 86-90                   |  |             |  |   |          |       |   |  |     |
|   |                                   |       |   | XLR 250 R 88-90                               |  |             |  |   |          |       |   |  |     |
|   |                                   |       |   | XR 350 RE 84                                  |  |             |  |   |          |       |   |  |     |
|   | CR 500 RE/RF/RG/RH/RJ 84-88       |       |   |   |  |             |  |   |          |       |   |  |     |
|   | XR 500 RD/RE 84-85                |       |   |   |  |             |  |   |          |       |   |  |     |
|   | XL 600 RD/LD/RE/LE/RF/RG/RH 83-87 |       |   |   |  |             |  |   |          |       |   |  |     |
|   | XL 600 LMF                        |       |   |   |  |             |  |   |          |       |   |  |     |
|   | XR 600 RF/RG/RH/RJ/RK/RL 85-90    |       |   |   |  |             |  |   |          |       |   |  |     |
| MD6068D   | FRONT                             | S     | XT 350 85-95                                      | 245   | MD6088D  |             |  | USE MD6088D   |          |       |   |  |     |
| MD6070D   | FRONT                             | S     | XT 600 84-87                                      | 267   | MD6089D  |             |  | USE MD6083D   |          |       |   |  |     |
|   |                                   |       | XT 600 Z Tenere 84-90                             |   | MD6090D  |             |  | USE MD6105D   |          |       |   |  |     |
|   |                                   |       | XT 600 E 92-94                                    |   | MD6091D  | FRONT       | S                                      | KLX 250 G1 94   | 250      |       |   |  |     |
| MD6072D   | REAR                              | S     | XT 600 87   | 220   | MD6092D  |             |  | USE MD6085D   |          |       |   |  |     |
|   |                                   |       | XT 600/600 Z Tenere 88-90                         |   | MD6093D  | FRONT       | S                                      | KLE 500 A1-A12/B1 91-05   | 300      |       |   |  |     |
|   |                                   |       | XT 600 E 92-03                                    |   |  |             |  | KLE 500 B1P/B6F/B7F 05-07   |          |       |   |  |     |
|   |                                   |       | XT 660 'Tenere' 91-98                             |   | MD6094D  | FRONT       | F                                      | DR 650 SET 96   | 290      |       |   |  |     |
| MD6073D   | FRONT                             | S     | DF 125 85-94                                      | 230   |  | REAR        | S                                      | DR 650 SET 96   | 240      |       |   |  |     |
|   |                                   |       | DR 125 SF/SH/SJ 85-94                             |   |  |             |  | XF 650 V/W/X/Y Freewind 97-02   |          |       |   |  |     |
|   |                                   |       | DR 125 SEX/SEY 99-01                              |   |  |             |  | MD6096D   |          | FRONT | S | XL 600 LMF 85                                  | 255 |
|   |                                   |       | TS 125 XUF/XUG/XUH/XUJ 86-90                      |   |  |             |  | MD6097D   |          | REAR  | S | XL 600 VM/VN/VP/VR/VT/VV/VW /VX Transalp 91-99 | 240 |
|   |                                   |       | DF 200 EV/EW/EY (SH42A) 86-89                     |   |  |             |  |   |          |       |   | XL 650 VY/V1-V7 Transalp 00-07                 |     |
|   |                                   |       | DR 200 G/H/J 86-89                                |   |  |             |  |   |          |       |   | XRV 650 J/K Africa Twin 88-89                  |     |
|   |                                   |       | DR 200 SEP/SER/SES/SEV /SEW/SEX/SEY (SH42A) 01-05 | MD6098D                                       |  |             | USE MD6013D                            |   |          |       |   |  |     |
| MD6075D   | FRONT                             | S     | TS 250 XE/XG/XH/XJ/XK 85-89                       | 240   | MD6099D  | REAR        | S                                      | NX 500 N/P/R/S/T/V/W/X 92-99  | 220      |       |   |  |     |
|   |                                   |       | DR 600 SF/RG/RH/SG/SH 85-87                       |   |  |             | NX 650 N/P/R/S/T/V/W/X Dominator 92-02 |   |          |       |   |  |     |
| MD6076D   | FRONT                             | S     | DR 650 RL/RM 90-91                                | 280   | MD6100D  |             |  | USE MD6010D   |          |       |   |  |     |
|   |                                   |       | DR 650 RSL/RSM (SP42A) 90-91                      |   | MD6101D  |             |  | USE MD6099D   |          |       |   |  |     |
|   |                                   |       | DR 750 SJ/SK 88-89                                |   | MD6102D/DR   | FRONT       | S                                      | XRV 750 L/M/N/P/R/S/T/V/W/X/Y 90-03   | 276      |       |   |  |     |
|   |                                   |       | DR 800 SL 90                                      |   | MD6103D  | REAR        | S                                      | XRV 750 L/M/N/P/R/S/T/V/W/X/Y 90-03   | 256      |       |   |  |     |
| MD6077D   | REAR                              | S     | DR 650 RL/RM 90-91                                | 250   |  |             |  | XL 1000 XV/VY/V2-V6 Varadero 99-06  |          |       |   |  |     |
|   |                                   |       | DR 650 RSL/RSM (SP42A) 90-91                      |   | MD6104D  |             |  | USE MD6083D   |          |       |   |  |     |
|   |                                   |       | DR 650 RUN/RN/RUP/RP (SP44A/B) 92-93              |   | MD6105D  | REAR        | S                                      | KDX 125 A1/A2/B1/B2 90-94   | 220      |       |   |  |     |
|   |                                   |       | DR 650 RSEM/RSEN/RSEP/RES 91-95                   |   |  |             | KDX 200 H1/H2/H3/H4/H5 95-99           |   |          |       |   |  |     |
|   |                                   |       | DR 750 SK 89                                      |   |  |             | KDX 200 SR (DX 200 G) 97-06            |   |          |       |   |  |     |
|   |                                   |       | DR 800 SL/SM 90-91                                |   |  |             | KDX 220 SR (DX 220 B) 91-93            |   |          |       |   |  |     |
| MD6078D   | FRONT                             | S     | DR 650 RSEM/RSEN/RSEP/RES 91-95                   | 300   |  |             | KDX 220 R A4-A12/A6F 97-06             |   |          |       |   |  |     |
|   |                                   |       | DR 650 RUN/RN/RUP/RP (SP44A/B) 92-93              |   |  |             |  | KDX 250 D1 91-93  |          |       |   |  |     |
| MD6080D   | FRONT                             | S     | KLR 600 A1/A3 B1-B4/B6-B9 84-94                   | 250   | MD6106D  | FRONT       | S                                      | KMX 125 A1-A5/B1-B12 86-03  | 230      |       |   |  |     |
| MD6081D   | FRONT                             | S     | KL 650 B1-B3 'Tengai' 89-92                       | 280   | MD6107D  | REAR        | S                                      | KMX 125 A1-A5/B1-B12 86-03  | 210      |       |   |  |     |
|   |                                   |       | KLR 650 C1-C10 95-04                              |   |  |             |  | KJ 250 J1-J3 00-02  |          |       |   |  |     |
| MD6082D   | REAR                              | S     | KLE 500 A1-A12/B1 91-05                           | 230   | MD6108D  | REAR        | S                                      | KMX 200 A2-A3 89-92   | 210      |       |   |  |     |
|   |                                   |       | KLE 500 B1P/B6F/B7F 05-07                         |   |  |             |  | KLX 250 J1/G1A/H1 Super Sherpa 97-98  |          |       |   |  |     |
|   |                                   |       | KL 650 B1-B3 'Tengai' 89-92                       |   | MD6109D  | FRONT       | S                                      | TS 125 RK/RL/RM/RN/RP/RR 90-96  | 240      |       |   |  |     |
|   |                                   |       | KLR 650 A1-A3 87-89                               |   |  |             | TS 200 RK/RL/RM/RN/RP/RR 89-94         |   |          |       |   |  |     |
|   |                                   |       | KLR 650 C1-C10 95-04                              |   |  |             |  |   |          |       |   |  |     |
| MD6083D   | FRONT                             | S     | KDX 125 A1/A2/B1/B2 90-94                         | 250   |  |             |  |   |          |       |   |  |     |
|   |                                   |       | KDX 200 H1/H2/H3/H4/H5 95-99                      |   |  |             |  |   |          |       |   |  |     |
|   |                                   |       | KDX 220 R A4-A12/A6F 97-06                        |   |  |             |  |   |          |       |   |  |     |
|   |                                   |       | KDX 220 SR (DX220B) 91                            |   |  |             |  |   |          |       |   |  |     |
|   |                                   |       | KDX 250 SR 91-93                                  |   |  |             |  |   |          |       |   |  |     |
|   |                                   |       | KDX 250 D1 91-93                                  |   |  |             |  |   |          |       |   |  |     |
| MD6084D   |                                   |       | USE MD6105D                                       |   |  |             |  |   |          |       |   |  |     |
| MD6085D   | REAR                              | S     | KLX 250 R D1-D2 93-94                             | 230   |  |             |  |   |          |       |   |  |     |
|   |                                   |       | KLX 250 G1 94-                                    |   |  |             |  |   |          |       |   |  |     |
|   |                                   |       | KLX 650 C1-C3 93-97                               |   |  |             |  |   |          |       |   |  |     |

★ = Note - Twin disc front - order D suffix for LHS - DR suffix for RHS

# OFF ROAD DISC BUYERS GUIDE

| DISC No.  | FRONT/ REAR | TYPE | MODELS   | DIA (MM) | DISC No.                      | FRONT/ REAR | TYPE        | MODELS  | DIA (MM) |
|---|-------------|------|--|----------|-------------------------------|-------------|-------------|---|----------|
| MD6110D   | REAR        | S    | DR 250 RS/RLS/RT/RLV/RLW<br>/RV/RW/RY (SJ45A/DOHC) 95-00<br>DR 250 RXT/RXLT/RXV/RXLV/RXW<br>/RXLW/RXGW/RXGLW/RXY/RXGY<br>(Dejbel 250 XC/GPS SJ45A) 96-98<br>DR-Z 250 K1-K7 01-07<br>DR 350 SET/SEV/SEW/SEX 96-99   | 220      | MD6126D<br>Contd.             | REAR        | S           | <b>HUSQVARNA</b><br>TE 410 95-99<br>TE 410 E 00<br>TE 510 90<br>TC 510 90<br>LT 610 00<br>SM 610 98-00<br>SM 610 R 00<br>TE 610 91-94<br>TE 610/E 95-00<br>TC 610 91-94<br>TC 610/E 95-99   | 220      |
| MD6111D   |             |      | <b>USE MD6094D</b>   |          |                               |             |             |   |          |
| MD6112D   |             |      | <b>USE MD6095D</b>   |          |                               |             |             |   |          |
| MD6113D/DR<br>★ Note<br> | FRONT       | F    | XF 650 V/W/X/Y Freewind 97-02<br>DR 800 SM 91  | 300      | MD6127D                       |             |             | <b>USE MD6095D</b>  |          |
| MD6114D   |             |      | <b>USE MD6039</b>  |          | MD6128D                       | REAR        | S           | Pegaso 650 91-00  | 220      |
| MD6115D   | REAR        | S    | DT 125 R 88-03<br>DT 125 RE 04-07<br>DT 125 X 05-06<br>TDR 125 R 93-03   | 220      | MD6129D                       | FRONT       | S           | <b>APRILIA</b><br>Pegaso 650/650 ie 91-04<br>Pegaso 650 Trail 06-07   | 300      |
| MD6116D   | FRONT       | S    | TDR 125 R 93-03<br>XT 600 E 95-03<br>XTZ 660 Tenere 91-98  | 280      | MD6130D<br>MD6130C<br>MD6130F | FRONT       | S<br>F<br>F | <b>KTM</b><br>EGS 400/EGS-E/LSE (LC4 Enduro) 96-99<br>LC4-E 400 Enduro 00-01<br>EGS/EGS-E/LSE 620 Enduro 96-99<br>LC-E 640 Enduro 00-04<br>LC4 640 Adventure R 00   | 300      |
| MD6117D   |             |      | <b>USE MD6116D</b>   |          | MD6131D                       | FRONT       | S           | KLF 300 C1-C17 89-05<br>KVF 300 A1-A4/B1-B4 (Prairie 4x4) 99-02<br>KLF 400 B1-B7 93-99<br>KVF 400 A1/A2/B1/C1-C4/D1-D4 97-02  | 200      |
| MD6118D   | FRONT       | S    | XTZ 750 Super Tenere 89-95   | 245      | MD6132D                       | REAR        | S           | KSF 250 A8-A18 94-04<br>KEF 300 B1/B2/B3 01-03  | 220      |
| MD6119D   | REAR        | S    | XTZ 750 Super Tenere 89-95   | 245      | MD6133D                       | FRONT       | S           | KSF 250 A8-A18 94-04<br>KXF 250 A1/A2 87-88<br>KEF 300 B1/B2/B3 01-03<br>KLF 300 B1-B17 'Bayou' 88-04   | 168      |
| MD6120D   |             |      | <b>USE MD6066D</b>   |          | MD6135D<br>MD6135C            | REAR        | S           | YZ 125/250 K/L/M/N 98-01<br>WR 250 ZK (5EN1) 98<br>WR/YZ 250 FN 01<br>YZ 400 FL 99<br>WR 400 FL/FM/FN 99-01<br>YZ 426 FM/FN/WR 426 FN 00-01   | 240      |
| MD6121D   | REAR        | S    | DT 200 WR 92-93<br>WR 200 D/E/F 92-94<br>DT 230 Lanza 4TP1/2 97-98<br>TT 250 R (4GY) Raid/4MR2 96<br>TT-R 250 RL/RM/RN/RP/RR/RS 99-04  | 220      | MD6136D                       | REAR        | S           | KXF 250 A1/A2 87-88   | 231      |
| MD6123D   | FRONT       | S    | YFM 350 FXG/FXH/FXJ/FXK/FXL/FXM<br>/FXN/FX/FXRP/FXS Wolverine 96-04<br>YFM 400 FAM 00<br>YFM 400 FWP/FPR/FPS Big Bear 4x4 02-04  | 180      | MD6137D                       | FRONT       | S           | KFX 450 R Quad 07<br>KSV 700 A1/B1/A2/A6F/B2/B6F (KFX 700) 04-06  | 163      |
| MD6124D<br>MD6124C  | REAR        | S    | CR 125 RW/RX/RY/R1 98-01<br>CR 250 RV/RW/RX/RY/R1 97-01  | 240      | MD6140D                       | FRONT       | S           | YFM 600 FWAK/FWAL/FWAM/FWAN<br>'Grizzly' 98-00<br>YFM 600HM "Grizzly Hunting" 00  | 220      |
| MD6125D   | FRONT       | S    | <b>HUSABERG</b><br>All Models 93-99<br><b>HUSQVARNA</b><br>CR 125 92-94<br>SM 125 98-99<br>WR 125 93-94<br>WRE 125 93-99<br>CR 250 92-99<br>WR 250 92-99<br>TE 350 92-97<br>CR 360 92-94<br>WR 360 92-99<br>TE 410 95-99<br>TE 610 92-94<br>TE 610/E 95-99<br>TC 610/E 95-99 | 260      | MD6141D                       | FRONT       | S           | <b>HUSABERG</b>   | 260      |
| MD6126D   | FRONT       | S    | <b>HUSQVARNA</b><br>CR 125 95-99<br>WR 125 95-99<br>TC 610 92-94   | 220      | MD6142D                       | REAR        | S           | <b>HUSABERG</b>   | 220      |
| MD6126D   | REAR        | S    | <b>HUSABERG</b><br>All Models 93-99<br><b>HUSQVARNA</b><br>CR 125 91-99<br>SM 125 98-99<br>WR 125 91/93-99<br>WRE 125 93-99<br>WR 240 90-91<br>CR 250 91-99<br>WR 250 90-99<br>WR 260 90-91<br>TE 350 90-97<br>CR 360 92-94<br>WR 360 92-99                                  | 220      | MD6144D                       | REAR        | S           | <b>HONDA</b><br>FL 400 R Pilot RK/RL 89-90  | 256      |
|   |             |      |  |          | MD6145D                       | FRONT       | S           | LT-F 500 FW/FX/FY/FK1/FK2 98-02   | 206      |
|   |             |      |  |          | MD6147D                       | FRONT       | S           | <b>POLARIS</b><br>Big Boss 250 4x6 89-90<br>Trail Boss 88-90<br>Trail Boss 4x4 87<br>Trail Boss 2x4/4x4 88-89<br>Trail Blazer 90  | 165      |
|   |             |      |  |          | MD6148D                       |             |             | <b>USE MD6214D</b>  |          |
|   |             |      |  |          | MD6149D                       | FRONT       | S           | <b>POLARIS</b><br>Big Boss 250 4x6 Middle Axle 89-92<br>Big Boss 250 6x6 91-92<br>Big Boss 350 L 93<br>Big Boss 300 6x6 Middle Axle 94<br>Big Boss 400 L 6x6 94-97<br>Big Boss 500 6x6 98-99<br>350 L 4x4 90<br>250 2x4/4x4 90<br>400 L 4x4 94<br>Magnum 325 4x4/2x4 00 | 228      |

★ = Note - Twin disc front - order D suffix for LHS - DR suffix for RHS

# OFF ROAD DISC BUYERS GUIDE

| DISC No.                           | FRONT/ REAR | TYPE | MODELS                                     | DIA (MM)     | DISC No.        | FRONT/ REAR | TYPE  | MODELS  | DIA (MM) |   |                                |     |         |       |   |                                       |     |   |                             |     |         |      |   |                                 |     |
|------------------------------------|-------------|------|--|--------------|-----------------|-------------|-------|---|----------|---|--------------------------------|-----|---------|-------|---|---------------------------------------|-----|---|-----------------------------|-----|---------|------|---|---------------------------------|-----|
| MD6149D Contd.                     | FRONT       | S    | <b>POLARIS</b>                             | 228          | MD6156 Contd.   | REAR        | S     | <b>POLARIS</b>  | 175      |   |                                |     |         |       |   |                                       |     |   |                             |     |         |      |   |                                 |     |
|                                    |             |      | Magnum 330 (2x4/HDS) 03-04                 |              |                 |             |       | Trail Boss 330 03-04  |          |   |                                |     |         |       |   |                                       |     |   |                             |     |         |      |   |                                 |     |
|                                    |             |      | Magnum 425 4x4 95-98                       |              |                 |             |       | Xpedition 425 4x4 00  |          |   |                                |     |         |       |   |                                       |     |   |                             |     |         |      |   |                                 |     |
|                                    |             |      | Magnum 425 6x6 96-97                       |              |                 |             |       | Xpedition 325 00  |          |   |                                |     |         |       |   |                                       |     |   |                             |     |         |      |   |                                 |     |
|                                    |             |      | Magnum 500 4x4 99-00                       |              |                 |             |       | Xplorer 4x4 400 01-02   |          |   |                                |     |         |       |   |                                       |     |   |                             |     |         |      |   |                                 |     |
|                                    |             |      | Magnum 500 01                              |              |                 |             |       |   |          |   |                                |     |         |       |   |                                       |     |   |                             |     |         |      |   |                                 |     |
|                                    |             |      | Magnum 500 (2x4/4x4 HDS) 02                |              |                 |             |       |   |          |   |                                |     |         |       |   |                                       |     |   |                             |     |         |      |   |                                 |     |
|                                    |             |      | Sportsman 350 4x4 93                       |              |                 |             |       |   |          |   |                                |     |         |       |   |                                       |     |   |                             |     |         |      |   |                                 |     |
|                                    |             |      | Sportsman 400 L 4x4 94-97                  |              |                 |             |       |   |          |   |                                |     |         |       |   |                                       |     |   |                             |     |         |      |   |                                 |     |
|                                    |             |      | Sportsman 400 01-04                        |              |                 |             |       |   |          |   |                                |     |         |       |   |                                       |     |   |                             |     |         |      |   |                                 |     |
|                                    |             |      | Sportsman 500 4x4 96-                      |              |                 |             |       |   |          |   |                                |     |         |       |   |                                       |     |   |                             |     |         |      |   |                                 |     |
|                                    |             |      | Sportsman/Worker 500 4x4 EBS/500 RSE 98-02 |              |                 |             |       |   |          |   |                                |     |         |       |   |                                       |     |   |                             |     |         |      |   |                                 |     |
|                                    |             |      | Sportsman/Worker 335 4x4 99-00             |              |                 |             |       |   |          |   |                                |     |         |       |   |                                       |     |   |                             |     |         |      |   |                                 |     |
| Sportsman 6x6 (500) Big Boss 00-01 |             |      |  |              |                 |             |       |   |          |   |                                |     |         |       |   |                                       |     |   |                             |     |         |      |   |                                 |     |
| Trail Boss 350 L 4x4 91            |             |      |  |              |                 |             |       |   |          |   |                                |     |         |       |   |                                       |     |   |                             |     |         |      |   |                                 |     |
| Xpedition 425 (4x4) 00             |             |      |  |              |                 |             |       |   |          |   |                                |     |         |       |   |                                       |     |   |                             |     |         |      |   |                                 |     |
| Xplorer 400 L 4x4 95-00            |             |      |  |              |                 |             |       |   |          |   |                                |     |         |       |   |                                       |     |   |                             |     |         |      |   |                                 |     |
| Xplorer 500 4x4 97                 |             |      |  |              |                 |             |       |   |          |   |                                |     |         |       |   |                                       |     |   |                             |     |         |      |   |                                 |     |
| Xplorer 400 01-02                  |             |      |  |              |                 |             |       |   |          |   |                                |     |         |       |   |                                       |     |   |                             |     |         |      |   |                                 |     |
| Diesel 455cc 4x4 EBS 99-00         |             |      |  |              |                 |             |       |   |          |   |                                |     |         |       |   |                                       |     |   |                             |     |         |      |   |                                 |     |
| Diesel 01                          |             |      |  |              |                 |             |       |   |          |   |                                |     |         |       |   |                                       |     |   |                             |     |         |      |   |                                 |     |
| PPS/PTV 6x6/Series 10              |             |      |  |              |                 |             |       |   |          |   |                                |     |         |       |   |                                       |     |   |                             |     |         |      |   |                                 |     |
| Ranger 99                          |             |      |  |              |                 |             |       |   |          |   |                                |     |         |       |   |                                       |     |   |                             |     |         |      |   |                                 |     |
| PPS LUH 6x6 02                     |             |      |  |              |                 |             |       |   |          |   |                                |     |         |       |   |                                       |     |   |                             |     |         |      |   |                                 |     |
| MD6150D                            | FRONT       | S    | <b>POLARIS</b>                             | 175          | MD6157D/C       | REAR        | S     | RM 125/250 X/Y/K1-K7 99-07                                      | 240      |   |                                |     |         |       |   |                                       |     |   |                             |     |         |      |   |                                 |     |
|                                    |             |      | Big Boss 250 4x6 91-92                     |              |                 |             |       | DR-Z 400 SMK5/K6/K7 05-07                                       |          |   |                                |     |         |       |   |                                       |     |   |                             |     |         |      |   |                                 |     |
|                                    |             |      | Big Boss 250 6x6 92-93                     |              |                 |             |       |   |          |   |                                |     |         |       |   |                                       |     |   |                             |     |         |      |   |                                 |     |
|                                    |             |      | Big Boss 300 6x6 94                        |              |                 |             |       |   |          |   |                                |     |         |       |   |                                       |     |   |                             |     |         |      |   |                                 |     |
|                                    |             |      | 350 L 2x4 90                               |              |                 |             |       |   |          |   |                                |     |         |       |   |                                       |     |   |                             |     |         |      |   |                                 |     |
|                                    |             |      | 250 2x4/4x4 93                             |              |                 |             |       |   |          |   |                                |     |         |       |   |                                       |     |   |                             |     |         |      |   |                                 |     |
|                                    |             |      | 350 L 4x4 93                               |              |                 |             |       |   |          |   |                                |     |         |       |   |                                       |     |   |                             |     |         |      |   |                                 |     |
|                                    |             |      | 300 2x4/4x4 94-95                          |              |                 |             |       |   |          |   |                                |     |         |       |   |                                       |     |   |                             |     |         |      |   |                                 |     |
|                                    |             |      | 400 L 2x4 94-95                            |              |                 |             |       |   |          |   |                                |     |         |       |   |                                       |     |   |                             |     |         |      |   |                                 |     |
|                                    |             |      | Magnum 425 2x4 95-98                       |              |                 |             |       |   |          |   |                                |     |         |       |   |                                       |     |   |                             |     |         |      |   |                                 |     |
|                                    |             |      | Scrambler 400 L 4x4 95-97                  |              |                 |             |       |   |          |   |                                |     |         |       |   |                                       |     |   |                             |     |         |      |   |                                 |     |
|                                    |             |      | Scrambler 500 4x4 97                       |              |                 |             |       |   |          |   |                                |     |         |       |   |                                       |     |   |                             |     |         |      |   |                                 |     |
|                                    |             |      | Sport 400 L 94-98                          |              |                 |             |       |   |          |   |                                |     |         |       |   |                                       |     |   |                             |     |         |      |   |                                 |     |
| Sport 400 99-00                    |             |      |  |              |                 |             |       |   |          |   |                                |     |         |       |   |                                       |     |   |                             |     |         |      |   |                                 |     |
| Sportsman 335 4x4 99-00            |             |      |  |              |                 |             |       |   |          |   |                                |     |         |       |   |                                       |     |   |                             |     |         |      |   |                                 |     |
| Trail Boss 250 91-99               |             |      |  |              |                 |             |       |   |          |   |                                |     |         |       |   |                                       |     |   |                             |     |         |      |   |                                 |     |
| Trail Boss 250 2x4/4x4 91-92       |             |      |  |              |                 |             |       |   |          |   |                                |     |         |       |   |                                       |     |   |                             |     |         |      |   |                                 |     |
| Trail Boss 350 L 2x4 91-93         |             |      |  |              |                 |             |       |   |          |   |                                |     |         |       |   |                                       |     |   |                             |     |         |      |   |                                 |     |
| Trail Blazer 91-93                 |             |      |  |              |                 |             |       |   |          |   |                                |     |         |       |   |                                       |     |   |                             |     |         |      |   |                                 |     |
| Trail Blazer 250 94-98             |             |      |  |              |                 |             |       |   |          |   |                                |     |         |       |   |                                       |     |   |                             |     |         |      |   |                                 |     |
| Xpedition 300/400 L 96-97          |             |      |  |              |                 |             |       |   |          |   |                                |     |         |       |   |                                       |     |   |                             |     |         |      |   |                                 |     |
| Xpress 300 2x4 98-00               |             |      |  |              |                 |             |       |   |          |   |                                |     |         |       |   |                                       |     |   |                             |     |         |      |   |                                 |     |
| Xplorer 300 4x4 96-00              |             |      |  |              |                 |             |       |   |          |   |                                |     |         |       |   |                                       |     |   |                             |     |         |      |   |                                 |     |
| MD6153D                            | FRONT       | S    | <b>POLARIS</b>                             | 253          | MD6158D MD6158C | FRONT       | S     | DT 50 LC 98-  | 220      |   |                                |     |         |       |   |                                       |     |   |                             |     |         |      |   |                                 |     |
|                                    |             |      | Big Boss 400 L 6x6 Middle Axle 96          |              |                 |             |       | TTR 125 LWM/LWN/LWP/LWR/LWES/LWS /LWET/LWT/LV/LEV/EW/LWEW 00-07 |          |   |                                |     |         |       |   |                                       |     |   |                             |     |         |      |   |                                 |     |
|                                    |             |      | Magnum 425 6x6 Middle Axle 96              |              |                 |             |       |   |          |   |                                |     |         |       |   |                                       |     |   |                             |     |         |      |   |                                 |     |
|                                    |             |      | MD6154D                                    |              |                 |             |       | REAR  |          | S | <b>POLARIS</b>                 | 150 | MD6159D | FRONT |   | <b>USE MD6149D</b>                    |     |   |                             |     |         |      |   |                                 |     |
|                                    |             |      |  |              |                 |             |       |   |          |   | Sportsman 500 97               |     |         |       |   |                                       |     |   |                             |     |         |      |   |                                 |     |
|                                    |             |      |  |              |                 |             |       |   |          |   | MD6155D                        |     |         |       |   | FRONT                                 |     | S | <b>POLARIS</b>              | 182 | MD6160D | REAR | S | Canyon 600 96-99                | 240 |
|                                    |             |      |  |              |                 |             |       |   |          |   |                                |     |         |       |   |                                       |     |   | Magnum 325 2X4/4X4 Mose 01  |     |         |      |   | E 750 Elephant 93-95            |     |
|                                    |             |      |  |              |                 |             |       |   |          |   |                                |     |         |       |   |                                       |     |   | Magnum 325 (2x4) HDS 02     |     |         |      |   | E 900 Elephant 93-99            |     |
|                                    |             |      |  |              |                 |             |       |   |          |   |                                |     |         |       |   |                                       |     |   | Magnum 325 4x4 02           |     |         |      |   | 900 IE Canyon/Gran Canyon 97-00 |     |
|                                    |             |      |  |              |                 |             |       |   |          |   |                                |     |         |       |   |                                       |     |   | Scrambler 400 (2x4/4x4) 00  |     |         |      |   |                                 |     |
|                                    |             |      |  |              |                 |             |       |   |          |   |                                |     |         |       |   |                                       |     |   | Scrambler 400 4x4/2x4 98-02 |     |         |      |   |                                 |     |
|                                    |             |      |  |              |                 |             |       |   |          |   |                                |     |         |       |   |                                       |     |   | Scrambler 500 4x4 98-00     |     |         |      |   |                                 |     |
|                                    |             |      |  |              |                 |             |       |   |          |   |                                |     |         |       |   |                                       |     |   | Scrambler 500 2x4/4x4 01-02 |     |         |      |   |                                 |     |
| Trail Boss 325 00-02               |             |      |  |              |                 |             |       |   |          |   |                                |     |         |       |   |                                       |     |   |                             |     |         |      |   |                                 |     |
| Trail Blazer 250 99-00             |             |      |  |              |                 |             |       |   |          |   |                                |     |         |       |   |                                       |     |   |                             |     |         |      |   |                                 |     |
| Trail Blazer 250 Freedom 01-02     |             |      |  |              |                 |             |       |   |          |   |                                |     |         |       |   |                                       |     |   |                             |     |         |      |   |                                 |     |
| Xpedition 325 00/02                |             |      |  |              |                 |             |       |   |          |   |                                |     |         |       |   |                                       |     |   |                             |     |         |      |   |                                 |     |
| Xplorer 250 4x4 00                 |             |      |  |              |                 |             |       |   |          |   |                                |     |         |       |   |                                       |     |   |                             |     |         |      |   |                                 |     |
| Xplorer 4x4 400 01-02              |             |      |  |              |                 |             |       |   |          |   |                                |     |         |       |   |                                       |     |   |                             |     |         |      |   |                                 |     |
| MD6156                             | REAR        | S    | <b>POLARIS</b>                             | 175          | MD6161D         | REAR        | S     | KX 125 E/E2/F1 86-88  | 220      |   |                                |     |         |       |   |                                       |     |   |                             |     |         |      |   |                                 |     |
|                                    |             |      | Magnum 325 (4x4) (2x4) 00                  |              |                 |             |       | KX 250 D2 86-   |          |   |                                |     |         |       |   |                                       |     |   |                             |     |         |      |   |                                 |     |
|                                    |             |      | Magnum 325 2x4/4x4 Mose 01                 |              |                 |             |       | KX 250 E1/F1 87-88  |          |   |                                |     |         |       |   |                                       |     |   |                             |     |         |      |   |                                 |     |
|                                    |             |      | Magnum 500 4x4 99-00                       |              |                 |             |       | KX 500 B2/C1/D1 86-88   |          |   |                                |     |         |       |   |                                       |     |   |                             |     |         |      |   |                                 |     |
|                                    |             |      | Magnum 500 01                              |              |                 |             |       |   |          |   |                                |     |         |       |   |                                       |     |   |                             |     |         |      |   |                                 |     |
|                                    |             |      | Scrambler 400 (2x4/4x4) 00                 |              |                 |             |       |   |          |   |                                |     |         |       |   |                                       |     |   |                             |     |         |      |   |                                 |     |
|                                    |             |      | Scrambler 400 4x4 98-02                    |              |                 |             |       |   |          |   |                                |     |         |       |   |                                       |     |   |                             |     |         |      |   |                                 |     |
|                                    |             |      | Scrambler 400 2x4 02                       |              |                 |             |       |   |          |   |                                |     |         |       |   |                                       |     |   |                             |     |         |      |   |                                 |     |
|                                    |             |      | Scrambler 500 4x4 98-00                    |              |                 |             |       |   |          |   |                                |     |         |       |   |                                       |     |   |                             |     |         |      |   |                                 |     |
|                                    |             |      | Scrambler 500 2x4/4x4 01-02                |              |                 |             |       |   |          |   |                                |     |         |       |   |                                       |     |   |                             |     |         |      |   |                                 |     |
|                                    |             |      | Sport 400 99-00                            |              |                 |             |       |   |          |   |                                |     |         |       |   |                                       |     |   |                             |     |         |      |   |                                 |     |
|                                    |             |      | Trail Boss 325 00-02                       |              |                 |             |       |   |          |   |                                |     |         |       |   |                                       |     |   |                             |     |         |      |   |                                 |     |
|                                    |             |      | Trail Blazer 250 99-00                     |              |                 |             |       |   |          |   |                                |     |         |       |   |                                       |     |   |                             |     |         |      |   |                                 |     |
| Trail Blazer 250 Freedom 01-02     |             |      |  |              |                 |             |       |   |          |   |                                |     |         |       |   |                                       |     |   |                             |     |         |      |   |                                 |     |
| MD6157D                            | FRONT       | S    | <b>POLARIS</b>                             | 253          | MD6162D         |             |       | <b>USE MD6014D</b>  |          |   |                                |     |         |       |   |                                       |     |   |                             |     |         |      |   |                                 |     |
|                                    |             |      | Big Boss 400 L 6x6 Middle Axle 96          |              |                 |             |       |   |          |   |                                |     |         |       |   |                                       |     |   |                             |     |         |      |   |                                 |     |
|                                    |             |      | Magnum 425 6x6 Middle Axle 96              |              |                 |             |       |   |          |   |                                |     |         |       |   |                                       |     |   |                             |     |         |      |   |                                 |     |
|                                    |             |      | MD6163D                                    |              |                 |             |       | FRONT   |          | S | <b>SUZUKI</b>                  | 240 | MD6163D | FRONT | S | RM 125/250 F/G/H/J 85-88              | 240 |   |                             |     |         |      |   |                                 |     |
|                                    |             |      |  |              |                 |             |       |   |          |   | Sportsman 500 97               |     |         |       |   |                                       |     |   |                             |     |         |      |   |                                 |     |
|                                    |             |      |  |              |                 |             |       |   |          |   | MD6164D                        |     |         |       |   | REAR                                  |     | S | <b>POLARIS</b>              | 150 | MD6164D | REAR | S | TRX 400 EXX/EXY/EX1-EX6 99-06   | 220 |
|                                    |             |      |  |              |                 |             |       |   |          |   |                                |     |         |       |   |                                       |     |   | Magnum 325 2X4/4X4 Mose 01  |     |         |      |   |                                 |     |
|                                    |             |      |  |              |                 |             |       |   |          |   |                                |     |         |       |   |                                       |     |   | Magnum 325 (2x4) HDS 02     |     |         |      |   |                                 |     |
|                                    |             |      |  |              |                 |             |       |   |          |   |                                |     |         |       |   |                                       |     |   | Magnum 325 4x4 02           |     |         |      |   |                                 |     |
|                                    |             |      |  |              |                 |             |       |   |          |   |                                |     |         |       |   |                                       |     |   | Scrambler 400 (2x4/4x4) 00  |     |         |      |   |                                 |     |
|                                    |             |      |  |              |                 |             |       |   |          |   |                                |     |         |       |   |                                       |     |   | Scrambler 400 4x4/2x4 98-02 |     |         |      |   |                                 |     |
|                                    |             |      |  |              |                 |             |       |   |          |   |                                |     |         |       |   |                                       |     |   | Scrambler 500 4x4 98-00     |     |         |      |   |                                 |     |
|                                    |             |      |  |              |                 |             |       |   |          |   |                                |     |         |       |   |                                       |     |   | Scrambler 500 2x4/4x4 01-02 |     |         |      |   |                                 |     |
| Trail Boss 325 00-02               |             |      |  |              |                 |             |       |   |          |   |                                |     |         |       |   |                                       |     |   |                             |     |         |      |   |                                 |     |
| Trail Blazer 250 99-00             |             |      |  |              |                 |             |       |   |          |   |                                |     |         |       |   |                                       |     |   |                             |     |         |      |   |                                 |     |
| Trail Blazer 250 Freedom 01-02     |             |      |  |              |                 |             |       |   |          |   |                                |     |         |       |   |                                       |     |   |                             |     |         |      |   |                                 |     |
| Xpedition 325 00/02                |             |      |  |              |                 |             |       |   |          |   |                                |     |         |       |   |                                       |     |   |                             |     |         |      |   |                                 |     |
| Xplorer 250 4x4 00                 |             |      |  |              |                 |             |       |   |          |   |                                |     |         |       |   |                                       |     |   |                             |     |         |      |   |                                 |     |
| Xplorer 4x4 400 01-02              |             |      |  |              |                 |             |       |   |          |   |                                |     |         |       |   |                                       |     |   |                             |     |         |      |   |                                 |     |
| MD6165D                            | FRONT       | S    | <b>POLARIS</b>                             | 182          | MD6165D         | REAR        | S     | CRM 250-1 (RK) M1/MD24 (10001-1008385) 89-90                    | 220      |   |                                |     |         |       |   |                                       |     |   |                             |     |         |      |   |                                 |     |
|                                    |             |      | Big Boss 400 L 6x6 Middle Axle 96          |              |                 |             |       | FMX 650 05-07   |          |   |                                |     |         |       |   |                                       |     |   |                             |     |         |      |   |                                 |     |
|                                    |             |      | Magnum 425 6x6 Middle Axle 96              |              |                 |             |       |   |          |   |                                |     |         |       |   |                                       |     |   |                             |     |         |      |   |                                 |     |
|                                    |             |      | MD6166D                                    |              |                 |             |       | FRONT   |          | S | <b>SUZUKI</b>                  | 180 | MD6166D | FRONT | S | KX 65 A1/A2/A3/A4/A5/A6/A6F/A7F 00-07 | 180 |   |                             |     |         |      |   |                                 |     |
|                                    |             |      |  |              |                 |             |       |   |          |   | Sportsman 500 97               |     |         |       |   |                                       |     |   |                             |     |         |      |   |                                 |     |
|                                    |             |      |  |              |                 |             |       |   |          |   | MD6166D                        |     |         |       |   | REAR                                  |     | S | <b>SUZUKI</b>               | 180 | MD6166D | REAR | S | RM 65 K3/K4/K5 03-05            | 180 |
|                                    |             |      |  |              |                 |             |       |   |          |   |                                |     |         |       |   |                                       |     |   | Magnum 325 2X4/4X4 Mose 01  |     |         |      |   |                                 |     |
|                                    |             |      |  |              |                 |             |       |   |          |   |                                |     |         |       |   |                                       |     |   | Magnum 325 (2x4) HDS 02     |     |         |      |   |                                 |     |
|                                    |             |      |  |              |                 |             |       |   |          |   |                                |     |         |       |   |                                       |     |   | Magnum 325 4x4 02           |     |         |      |   |                                 |     |
|                                    |             |      |  |              |                 |             |       |   |          |   |                                |     |         |       |   |                                       |     |   | Scrambler 400 (2x4/4x4) 00  |     |         |      |   |                                 |     |
|                                    |             |      |  |              |                 |             |       |   |          |   |                                |     |         |       |   |                                       |     |   | Scrambler 400 4x4/2x4 98-02 |     |         |      |   |                                 |     |
|                                    |             |      |  |              |                 |             |       |   |          |   |                                |     |         |       |   |                                       |     |   | Scrambler 500 4x4 98-00     |     |         |      |   |                                 |     |
|                                    |             |      |  |              |                 |             |       |   |          |   |                                |     |         |       |   |                                       |     |   | Scrambler 500 2x4/4x4 01-02 |     |         |      |   |                                 |     |
| Trail Boss 325 00-02               |             |      |  |              |                 |             |       |   |          |   |                                |     |         |       |   |                                       |     |   |                             |     |         |      |   |                                 |     |
| Trail Blazer 250 99-00             |             |      |  |              |                 |             |       |   |          |   |                                |     |         |       |   |                                       |     |   |                             |     |         |      |   |                                 |     |
| Trail Blazer 250 Freedom 01-02     |             |      |  |              |                 |             |       |   |          |   |                                |     |         |       |   |                                       |     |   |                             |     |         |      |   |                                 |     |
| Xpedition 325 00/02                |             |      |  |              |                 |             |       |   |          |   |                                |     |         |       |   |                                       |     |   |                             |     |         |      |   |                                 |     |
| Xplorer 250 4x4 00                 |             |      |  |              |                 |             |       |   |          |   |                                |     |         |       |   |                                       |     |   |                             |     |         |      |   |                                 |     |
| Xplorer 4x4 400 01-02              |             |      |  |              |                 |             |       |   |          |   |                                |     |         |       |   |                                       |     |   |                             |     |         |      |   |                                 |     |
| MD6168D                            | FRONT       | S    | <b>HONDA</b>                               | 296          | MD6168D         | FRONT       | S     | XRV 650 J Africa Twin 88-89                                     | 296      |   |                                |     |         |       |   |                                       |     |   |                             |     |         |      |   |                                 |     |
|                                    |             |      | Sportsman 500 97                           |              |                 |             |       |   |          |   |                                |     |         |       |   |                                       |     |   |                             |     |         |      |   |                                 |     |
|                                    |             |      | MD6169D                                    |              |                 |             |       | FRONT   |          | S | <b>POLARIS</b>                 | 203 | MD6169D | FRONT | S | Sportsman 6x6 02-04                   | 203 |   |                             |     |         |      |   |                                 |     |
|                                    |             |      |  |              |                 |             |       |   |          |   | Magnum 325 2X4/4X4 Mose 01     |     |         |       |   |                                       |     |   |                             |     |         |      |   |                                 |     |
|                                    |             |      |  |              |                 |             |       |   |          |   | Magnum 325 (2x4) HDS 02        |     |         |       |   |                                       |     |   |                             |     |         |      |   |                                 |     |
|                                    |             |      |  |              |                 |             |       |   |          |   | Magnum 325 4x4 02              |     |         |       |   |                                       |     |   |                             |     |         |      |   |                                 |     |
|                                    |             |      |  |              |                 |             |       |   |          |   | Scrambler 400 (2x4/4x4) 00     |     |         |       |   |                                       |     |   |                             |     |         |      |   |                                 |     |
|                                    |             |      |  |              |                 |             |       |   |          |   | Scrambler 400 4x4/2x4 98-02    |     |         |       |   |                                       |     |   |                             |     |         |      |   |                                 |     |
|                                    |             |      |  |              |                 |             |       |   |          |   | Scrambler 500 4x4 98-00        |     |         |       |   |                                       |     |   |                             |     |         |      |   |                                 |     |
|                                    |             |      |  |              |                 |             |       |   |          |   | Scrambler 500 2x4/4x4 01-02    |     |         |       |   |                                       |     |   |                             |     |         |      |   |                                 |     |
|                                    |             |      |  |              |                 |             |       |   |          |   | Trail Boss 325 00-02           |     |         |       |   |                                       |     |   |                             |     |         |      |   |                                 |     |
|                                    |             |      |  |              |                 |             |       |   |          |   | Trail Blazer 250 99-00         |     |         |       |   |                                       |     |   |                             |     |         |      |   |                                 |     |
|                                    |             |      |  |              |                 |             |       |   |          |   | Trail Blazer 250 Freedom 01-02 |     |         |       |   |                                       |     |   |                             |     |         |      |   |                                 |     |
| Xpedition 325 00/02                |             |      |  |              |                 |             |       |   |          |   |                                |     |         |       |   |                                       |     |   |                             |     |         |      |   |                                 |     |
| Xplorer 250 4x4 00                 |             |      |  |              |                 |             |       |   |          |   |                                |     |         |       |   |                                       |     |   |                             |     |         |      |   |                                 |     |
| Xplorer 4x4 400 01-02              |             |      |  |              |                 |             |       |   |          |   |                                |     |         |       |   |                                       |     |   |                             |     |         |      |   |                                 |     |
| MD6169D                            | REAR        | S    | <b>POLARIS</b>                             | 203          | MD6169D         | REAR        | S     | Xplorer 400 L (4x4) 99-02                                       | 203      |   |                                |     |         |       |   |                                       |     |   |                             |     |         |      |   |                                 |     |
|                                    |             |      | Sportsman 500 97                           |              |                 |             |       |   |          |   |                                |     |         |       |   |                                       |     |   |                             |     |         |      |   |                                 |     |
|                                    |             |      | MD6170D                                    |              |                 |             |       | FRONT   |          | S | <b>POLARIS</b>                 | 228 | MD6170D | FRONT | S | Sportsman 6x6 (500) 00-04             | 228 |   |                             |     |         |      |   |                                 |     |
|                                    |             |      |  |              |                 |             |       |   |          |   | Magnum 325 2X4/4X4 Mose 01     |     |         |       |   | PPS LUH 6x6 02                        |     |   |                             |     |         |      |   |                                 |     |
|                                    |             |      |  |              |                 |             |       |   |          |   | Magnum 325 (2x4) HDS 02        |     |         |       |   |                                       |     |   |                             |     |         |      |   |                                 |     |
|                                    |             |      |  |              |                 |             |       |   |          |   | Magnum 325 4x4 02              |     |         |       |   |                                       |     |   |                             |     |         |      |   |                                 |     |
|                                    |             |      |  |              |                 |             |       |   |          |   | Scrambler 400 (2x4/4x4) 00     |     |         |       |   |                                       |     |   |                             |     |         |      |   |                                 |     |
|                                    |             |      |  |              |                 |             |       |   |          |   | Scrambler 400 4x4/2x4 98-02    |     |         |       |   |                                       |     |   |                             |     |         |      |   |                                 |     |
|                                    |             |      |  |              |                 |             |       |   |          |   | Scrambler 500 4x4 98-00        |     |         |       |   |                                       |     |   |                             |     |         |      |   |                                 |     |
|                                    |             |      |  |              |                 |             |       |   |          |   | Scrambler 500 2x4/4x4 01-02    |     |         |       |   |                                       |     |   |                             |     |         |      |   |                                 |     |
|                                    |             |      |  |              |                 |             |       |   |          |   | Trail Boss 325 00-02           |     |         |       |   |                                       |     |   |                             |     |         |      |   |                                 |     |
|                                    |             |      |  |              |                 |             |       |   |          |   | Trail Blazer 250 99-00         |     |         |       |   |                                       |     |   |                             |     |         |      |   |                                 |     |
|                                    |             |      |  |              |                 |             |       |   |          |   | Trail Blazer 250 Freedom 01-02 |     |         |       |   |                                       |     |   |                             |     |         |      |   |                                 |     |
| Xpedition 325 00/02                |             |      |  |              |                 |             |       |   |          |   |                                |     |         |       |   |                                       |     |   |                             |     |         |      |   |                                 |     |
| Xplorer 250 4x4 00                 |             |      |  |              |                 |             |       |   |          |   |                                |     |         |       |   |                                       |     |   |                             |     |         |      |   |                                 |     |
| Xplorer 4x4 400 01-02              |             |      |  |              |                 |             |       |   |          |   |                                |     |         |       |   |                                       |     |   |                             |     |         |      |   |                                 |     |
| MD6171D                            | FRONT       | S    | <b>BOMBARDIER</b>                          | 166          | MD6171D         | FRONT       | S     | DS 650 00-04  | 166      |   |                                |     |         |       |   |                                       |     |   |                             |     |         |      |   |                                 |     |
|                                    |             |      | Sportsman 500 97                           |              |                 |             |       |   |          |   |                                |     |         |       |   |                                       |     |   |                             |     |         |      |   |                                 |     |
|                                    |             |      | MD6172D                                    |              |                 |             |       | REAR  |          | S | <b>BOMBARDIER</b>              | 196 | MD6172D | REAR  | S | DS 650 00-04                          | 196 |   |                             |     |         |      |   |                                 |     |
|                                    |             |      |  |              |                 |             |       |   |          |   | Magnum 325 2X4/4X4 Mose 01     |     |         |       |   |                                       |     |   |                             |     |         |      |   |                                 |     |
|                                    |             |      |  |              |                 |             |       |   |          |   | Magnum 325 (2x4) HDS 02        |     |         |       |   |                                       |     |   |                             |     |         |      |   |                                 |     |
|                                    |             |      |  |              |                 |             |       |   |          |   | Magnum 325 4x4 02              |     |         |       |   |                                       |     |   |                             |     |         |      |   |                                 |     |
|                                    |             |      |  |              |                 |             |       |   |          |   | Scrambler 400 (2x4/4x4) 00     |     |         |       |   |                                       |     |   |                             |     |         |      |   |                                 |     |
|                                    |             |      |  |              |                 |             |       |   |          |   | Scrambler 400 4x4/2x4 98-02    |     |         |       |   |                                       |     |   |                             |     |         |      |   |                                 |     |
|                                    |             |      |  |              |                 |             |       |   |          |   | Scrambler 500 4x4 98-00        |     |         |       |   |                                       |     |   |                             |     |         |      |   |                                 |     |
|                                    |             |      |  |              |                 |             |       |   |          |   | Scrambler 500 2x4/4x4 01-02    |     |         |       |   |                                       |     |   |                             |     |         |      |   |                                 |     |
|                                    |             |      |  |              |                 |             |       |   |          |   | Trail Boss 325 00-02           |     |         |       |   |                                       |     |   |                             |     |         |      |   |                                 |     |
|                                    |             |      |  |              |                 |             |       |   |          |   | Trail Blazer 250 99-00         |     |         |       |   |                                       |     |   |                             |     |         |      |   |                                 |     |
|                                    |             |      |  |              |                 |             |       |   |          |   | Trail Blazer 250 Freedom 01-02 |     |         |       |   |                                       |     |   |                             |     |         |      |   |                                 |     |
| Xpedition 325 00/02                |             |      |  |              |                 |             |       |   |          |   |                                |     |         |       |   |                                       |     |   |                             |     |         |      |   |                                 |     |
| Xplorer 250 4x4 00                 |             |      |  |              |                 |             |       |   |          |   |                                |     |         |       |   |                                       |     |   |                             |     |         |      |   |                                 |     |
| Xplorer 4x4 400 01-02              |             |      |  |              |                 |             |       |   |          |   |                                |     |         |       |   |                                       |     |   |                             |     |         |      |   |                                 |     |
| MD6173D                            | FRONT /REAR | S    | <b>MASSEY FERGUSON</b>                     | 202          | MD6173D         | FRONT /REAR | S     | MF 250/300/400/500 (2WD/4WD) 04                                 | 202      |   |                                |     |         |       |   |                                       |     |   |                             |     |         |      |   |                                 |     |
|                                    |             |      | Sportsman 500 97                           |              |                 |             |       |   |          |   |                                |     |         |       |   |                                       |     |   |                             |     |         |      |   |                                 |     |
|                                    |             |      | MD6174D                                    |              |                 |             |       | REAR  |          | S | <b>YAMAHA</b>                  | 220 | MD6174D | REAR  | S | YFM 400 FAM/FAN 00-01                 | 220 |   |                             |     |         |      |   |                                 |     |
|                                    |             |      |  |              |                 |             |       |   |          |   | Magnum 325 2X4/4X4 Mose 01     |     |         |       |   |                                       |     |   |                             |     |         |      |   |                                 |     |
|                                    |             |      |  |              |                 |             |       |   |          |   | Magnum 325 (2x4) HDS 02        |     |         |       |   |                                       |     |   |                             |     |         |      |   |                                 |     |
|                                    |             |      |  |              |                 |             |       |   |          |   | Magnum 325 4x4 02              |     |         |       |   |                                       |     |   |                             |     |         |      |   |                                 |     |
|                                    |             |      |  |              |                 |             |       |   |          |   | Scrambler 400 (2x4/4x4) 00     |     |         |       |   |                                       |     |   |                             |     |         |      |   |                                 |     |
|                                    |             |      |  |              |                 |             |       |   |          |   | Scrambler 400 4x4/2x4 98-02    |     |         |       |   |                                       |     |   |                             |     |         |      |   |                                 |     |
|                                    |             |      |  |              |                 |             |       |   |          |   | Scrambler 500 4x4 98-00        |     |         |       |   |                                       |     |   |                             |     |         |      |   |                                 |     |
|                                    |             |      |  |              |                 |             |       |   |          |   | Scrambler 500 2x4/4x4 01-02    |     |         |       |   |                                       |     |   |                             |     |         |      |   |                                 |     |
|                                    |             |      |  |              |                 |             |       |   |          |   | Sport 400 99-00                |     |         |       |   |                                       |     |   |                             |     |         |      |   |                                 |     |
|                                    |             |      |  |              |                 |             |       |   |          |   | Trail Boss 325 00-02           |     |         |       |   |                                       |     |   |                             |     |         |      |   |                                 |     |
|                                    |             |      |  |              |                 |             |       |   |          |   | Trail Blazer 250 99-00         |     |         |       |   |                                       |     |   |                             |     |         |      |   |                                 |     |
| Trail Blazer 250 Freedom 01-02     |             |      |  |              |                 |             |       |   |          |   |                                |     |         |       |   |                                       |     |   |                             |     |         |      |   |                                 |     |
| MD6175D                            | FRONT       | S    |  | <b>DERBI</b> | 218             | MD6175D     | FRONT |   | S        |   | Senda-R 96-99                  |     |         |       |   | 218                                   |     |   |                             |     |         |      |   |                                 |     |
|                                    |             |      | Magnum 325 2X4/4X4 Mose 01                 |              |                 |             |       |   |          |   |                                |     |         |       |   |                                       |     |   |                             |     |         |      |   |                                 |     |
|                                    |             |      | Magnum 325 (2x4) HDS 02                    |              |                 |             |       |   |          |   |                                |     |         |       |   |                                       |     |   |                             |     |         |      |   |                                 |     |
|                                    |             |      | Magnum 325 4x4 02                          |              |                 |             |       |   |          |   |                                |     |         |       |   |                                       |     |   |                             |     |         |      |   |                                 |     |
|                                    |             |      | Scrambler 400 (2x4/4x4) 00                 |              |                 |             |       |   |          |   |                                |     |         |       |   |                                       |     |   |                             |     |         |      |   |                                 |     |
|                                    |             |      | Scrambler 400 4x4/2x4 98-02                |              |                 |             |       |   |          |   |                                |     |         |       |   |                                       |     |   |                             |     |         |      |   |                                 |     |
|                                    |             |      | Scrambler 500 4x4 98-00                    |              |                 |             |       |   |          |   |                                |     |         |       |   |                                       |     |   |                             |     |         |      |   |                                 |     |
|                                    |             |      | Scrambler 500 2x4/4x4 01-02                |              |                 |             |       |   |          |   |                                |     |         |       |   |                                       |     |   |                             |     |         |      |   |                                 |     |
|                                    |             |      | Sport 400 99-00                            |              |                 |             |       |   |          |   |                                |     |         |       |   |                                       |     |   |                             |     |         |      |   |                                 |     |
|                                    |             |      | Trail Boss 325 00-02                       |              |                 |             |       |   |          |   |                                |     |         |       |   |                                       |     |   |                             |     |         |      |   |                                 |     |
|                                    |             |      | Trail Blazer 250 99-00                     |              |                 |             |       |   |          |   |                                |     |         |       |   |                                       |     |   |                             |     |         |      |   |                                 |     |
|                                    |             |      | Trail Blazer 250 Freedom 01-02             |              |                 |             |       |   |          |   |                                |     |         |       |   |                                       |     |   |                             |     |         |      |   |                                 |     |

★ = Note - Twin disc front - order D suffix for LHS - DR suffix for RHS



# OFF ROAD DISC BUYERS GUIDE

| DISC No. | FRONT/ REAR | TYPE | MODELS   | DIA (MM) | DISC No.  | FRONT/ REAR | TYPE | MODELS   | DIA (MM) |
|----------|-------------|------|--|----------|---|-------------|------|--|----------|
| MD6176D  | REAR        | S    | N/A  |          | MD6191D   | REAR        | S    | CRF 450 X5/X6/X7 05-07   | 240      |
| MD6180D  | FRONT       | S    | <b>APRILIA</b><br>Tuareg Wind 600 89   | 260      | MD6191C   |             |      | CRM F 450 R Supermoto 07   |          |
|          |             |      |  |          | Contd.  |             |      | CRM F 450 X Supermoto 07   |          |
|          |             |      |  |          |   |             |      | CRE F 490 X 07   |          |
| MD6181D  | REAR        | S    | XR 650 RY/R1-R7 00-07<br><b>HONDA-DALL'ARA</b><br>XR 650 R 04  | 240      | MD6192D   | FRONT       | S    | <b>KTM</b><br>60 SX 98-00<br>65 SX 00-03   | 198      |
| MD6182D  | FRONT       | S    | TT 600 E (4LW3/4LW4/4GV4/4GV5)94-01<br>TT 600 E (4GV2) 94-95<br>TT 600 K (4LW1/4GV1/4LW2) 93-96<br>TT 600 R (5CH1/5CH2/5CH3)97-02<br>TT 600 RE (5CH5) 04   | 267      | MD6195D   | FRONT       | S    | LT-A 400 FK2/K2/FK3/K3/K4/FK4<br>/FK5/FK6/FK7 Eiger 4WD 02-07<br>LT-F 400 FK2/K2/FK3/K3/FK4<br>/K4/FK5/FK6/FK7 Eiger 02-07<br>LT-A 500 FK2/FK3/FK4/FK5/FK6/FK7<br>Vinson 4WD 02-07<br>LT-F 500 FK3/FK4/FK5/FK6/FK7 03-07   | 190      |
| MD6183D  | REAR        | S    | TT 600 E (4LW3/4LW4/4GV4/4GV5)94-01<br>TT 600 E (4GV2) 94-95<br>TT 600 K (4LW1/4GV1/4LW2) 93-96<br>TT 600 R (5CH1/5CH2/5CH3)97-02<br>TT 600 RE (5CH5) 04   | 220      | MD6196D   | REAR        | S    | LT-A 500 FK2/FK3/FK4/FK5/FK6/FK7<br>Vinson 4WD 02-07<br>LT-F 500 FK3/FK4/FK5/FK6/FK7 03-07   | 216      |
| MD6184D  | FRONT       | S    | <b>HUSQVARNA</b><br>CR 125 00-07<br>SM 125 00<br>SM 125 S 02-07<br>WR 125 00-07<br>WRE 125 00/02-07<br>WXE 125 07<br>CR 250 00-05<br>TC 250 02-03/05-07<br>TE 250 02-07<br>WR 250 00-07<br>WR 360 00-02<br>TE 400 02<br>TE 410 00/06<br>TE 410 E 00<br>TC 450 03/05-07<br>TE 450 03-07<br>TC 510 04-07<br>TE 510 04-07<br>TC 570 02-03<br>TE 570 01-04<br>TC 610 00<br>TE 610 00<br>TE 610 E 00/02-03<br>TE 610/IE 06-07 | 260      | MD6197D   | REAR        | S    | YFM 660 FWAP/FWAR/FWAS<br>/FWAT/FWAV/FGW Grizzly 02-07<br>YFM 660 FR/FS/FT Grizzly 03-05   | 148      |
|          |             |      |  |          | MD6198D   | REAR        | S    | AX-1 (NX 250 J/K/R/R3) 89-94   | 220      |
|          |             |      |  |          | MD6199D   | FRONT       | F    | <b>KTM</b> Duke 400 LC4 94-98<br>Duke 620 LC4<br>LC4 620 SC Supermoto 00<br>LC4 625 SC Supermoto 02<br>SMC 625 05<br>Duke II 640 01-06<br>LC4-E 640 Supermoto 00-06<br>LC4 640 Adventure 01-02   | 320      |
|          |             |      |  |          |  |             |      |  |          |
|          |             |      |  |          | MD6199C   |             |      |  |          |
|          |             |      |  |          | MD6200D   | REAR        | S    | <b>POLARIS</b><br>Magnum 325 2x4 HDS 02<br>Magnum 325 4x4 02<br>Magnum 325 4x4 HDS 02<br>Magnum 330 (4x4/HDS) 03-04<br>Magnum 500 (2x4/4x4 HDS)02-03<br>Xpedition 325 02<br>PPS/PTV 4x4/Series 10<br>PPS/PTV 6x6/Series 10   | 206      |
| MD6186D  | FRONT       | S    | KX 85/85 II A1-A5/A6F/A7F/B1-B5<br>/B6F/B7F 01-07<br><b>SUZUKI</b> - RM 100 K3 03  | 220      | MD6201D   | REAR        | S    | Sportsman 500 X2 06<br>Sportsman 600 (4x4) 03-04<br>Sportsman 700 4x4 02-04<br>Sportsman MV 700 05<br>Sportsman 800 05<br>PPS/Series 10 UTV 2x4/4x6<br>PPS/Series II UTV 1500 2x4<br>PPS/Series 11 2x4/4x4/6x6<br>Ranger 6x6 04-05<br>Ranger TM 04-05<br>Ranger XP 05<br>Ranger 2x4/4x4 04-06<br>Ranger Series 10<br>Ranger Series 10 500 6x6<br>Ranger Series 11  | 218      |
| MD6187D  | REAR        | S    | KX 85/85 II A1-A5/A6F/A7F/B1-B5<br>/B6F/B7F 01-07<br><b>SUZUKI</b> - RM 100 K3 03  | 184      |   |             |      |  |          |
| MD6187C  |             |      |  |          | MD6202D   | FRONT /REAR | S    | <b>POLARIS</b><br>Magnum 325 4x4 HDS 02<br>ATP 330 (4x4) 04<br>Magnum 330 (4x4/HDS) 03-04<br>ATP 500 HO (4x4) 04<br>Magnum 500 HDS 02-03<br>Sportsman 500 HO 03-04<br>Sportsman 700 (4x4) 02-04<br>Sportsman MV 700 05<br>Sportsman 800 05<br>PPS/PTV 4x4/Series 10<br>PPS/Series 10 UTV 2x4/4x6<br>PPS/Series II UTV 1500 2x4<br>PPS/Series 11 2x4/4x4/6x6<br>Ranger 6x6 04-05<br>Ranger TM 04-06<br>Ranger XP 05<br>Ranger 2x4/4x4 04-06<br>Ranger 500 (2x4/4x4/4x4 EFi) 06<br>Ranger 6x6 EFi 700 06<br>Ranger XP 700 4x4 06<br>Ranger Series 10<br>Ranger Series 10 500 6x6<br>Ranger Series 11 | 228      |
| MD6188D  | FRONT       | S    | KVF 360 A1-A3/A6F/B1-B3<br>/B6F/C1-C3/C6F 03-06<br>KVF 650 A1/A2 02-03<br>KVF 650 D1/D6F Brute Force 4x4 05-06<br>KVF 650 E1/E6F Brute Force 4x4<br>Hardwoods Green HD 05-06<br>KVF 700 A1/B1/B6F/A2/B2/A6F<br>4x4 (Prairie) 04-06<br>KVF 700 D1 Team Green 05<br>KVF 750 A1/B1/A6F/B6F Brute Force 4x4 05-06  | 200      |   |             |      |  |          |
| MD6189D  | FRONT       | S    | YFM 660 FWAP/FWAR/FWAS<br>/FWAT/FWAV/FGW Grizzly 02-07<br>YFM 660 FR/FS/FT Grizzly 03-05   | 220      |   |             |      |  |          |
| MD6190D  | REAR        | S    | YZ 125/250 P/R/S/T/V/W 02-07<br>WR 250 FP/FR/FS/FT/FV/FW 02-07<br>YZ 250 FP/FR/FS/FT/FV/FW 02-07<br>YZ/WR 426 FP 02<br>YZ/WR 450 FR/FS/FT/FV/FW 03-07  | 245      |   |             |      |  |          |
| MD6190C  |             |      |  |          |   |             |      |  |          |
| MD6191D  | REAR        | S    | CR 125 R2/R3/R4/R5/R6/R7 02-07<br>CRM 125 R Supermoto 07<br>CR 250 R2/R3/R4/R5/R6/R7 02-07<br>CRE 250 X<br>CRF 250 R4/R5/R6/R7 04-07<br>CRF 250 X4/X5/X6/X7 04-07<br>CRM 250 X Supermoto 07<br>CRE F 290 X 07<br>CRE 450 X<br>CRF 450 R2/R3/R4/R5/R6/R7 02-07  | 240      |   |             |      |  |          |
| MD6191C  |             |      |  |          |   |             |      |  |          |

\* = Note - Twin disc front - order D suffix for LHS - DR suffix for RHS

# OFF ROAD DISC BUYERS GUIDE

| DISC No.           | FRONT/ REAR | TYPE | MODELS   | DIA (MM) | DISC No.           | FRONT/ REAR | TYPE | MODELS   | DIA (MM) |
|--------------------|-------------|------|--|----------|--------------------|-------------|------|--|----------|
| MD6203D            |             |      | USE MD6188D  |          | MD6223D            | REAR        | S    | <b>BOMBARDIER</b><br>Outlander 330/400 03-04<br>Outlander 800 06<br><b>CAN AM</b><br>Outlander 400/500/650/800 07<br>Outlander Max 400/500/650/800 07  | 180      |
| MD6206D            | FRONT       | S    | LT-F 300 FK2 02  | 168      | MD6224D            | FRONT /REAR | S    | <b>BOMBARDIER</b><br>Traxter 01-04<br>Quest 500/650 02-04  | 203      |
| MD6207D            | FRONT       | S    | LT-Z 250 K4/K5/K6/K7 QuadSport 04-07<br>LT-F 250 K2-K6 Ozark 02-06   | 160      | MD6225D            | FRONT /REAR | S    | <b>BOMBARDIER</b><br>Traxter 01-04<br>Quest 500/650 02-04<br>Traxter Max 650 04-05<br>Traxter XL (7920/7921) 04<br>Quest Max/STD/XT 04-05<br><b>JOHN DEERE ATV</b><br>Trail Buck 500 Utility 04-05<br>Trail Buck 650/650 EX/EXT 04-05<br>Buck 500/500 EX/EXT 04-05 | 218      |
| MD6208D<br>MD6208C | REAR        | S    | KX 125 M1/M2/M3/M6F/M7F 03-07<br>KX 250 F (KX 250 N1/N2) 04-05<br>KX 250 M1/M2/R1/R6F/R7F 03-07<br>KX 250 F (T6F/T7F) 06-07<br>KX 450 F (D6F/D7F) 06-07<br>KLX 450 R (A8F) 07<br><b>SUZUKI</b><br>RM-Z 250 K4/K5/K6 04-06  | 240      | MD6226D            | FRONT       | F    | XT 660 X Supermoto 04-07   | 320      |
| MD6209D            | FRONT       | F    | 404 DS Supermoto 03-04<br>604 E Supermoto 99-03<br>604 RS "Roadster" 00-03<br>644 DS Supermoto 04<br>644 DS 04<br>R 30 (Spoke wheel) 02-04   | 320      | MD6227D            | REAR        | S    | <b>KTM</b> MX/MXC/GS 125 86<br>MX 125 88-89<br>EXC 125 88-89<br>MX/MXC 250 86<br>GS 250 86<br>MX 250 88-89<br>EXC/EGS 250 88-89<br>MX/MXC/GS 300 86<br>MX/MXC/GS 350 86/88<br>MX 350 89<br>EXC 350 89  | 220      |
| MD6210D            | FRONT       | S    | LT-Z 400 K3/K4/K5/K6/K7 03-07<br>KSF 400 A1/A2/A3 03-05<br>DVX 400 04  | 170      | MD6228D            | FRONT       | S    | Use MD6229D  |          |
| MD6211D            | REAR        | S    | LT-Z 400 K3/K4/K5/K6/K7 03-07<br>KSF 400 A1/A2/A3 03-05<br>DVX 400 04  | 220      | MD6229D            | FRONT       | S    | <b>BOMBARDIER</b><br>Traxter 99-04   | 205      |
| MD6212D            | FRONT       | S    | DR-Z 125 LK3/LK4/LK5/LK6/LK7 03-07<br>KLX 125 L (B1/B2/B3/A6F) 03-06   | 220      | MD6230D            | REAR        | S    | <b>BOMBARDIER</b><br>Traxter 99-04   | 220      |
| MD6213D<br>MD6213C | FRONT       | S    | KX 125 M1/M2/M3 03-04<br>KX 250 N1/N2 04-05<br>KX 250 M1/M2/R1 03-05<br>RM-Z 250 K4/K5/K6 04-06  | 250      | MD6231D            | FRONT       | F    | Use MD3088LS/RS  |          |
| MD6214D            | FRONT       | S    | DT 50 R-L 97-03<br>MX 50 03-05<br>RX 3-5 Marce (M/N/P/R) 91-94<br>RX 50 C/CD 95-04   | 230      | MD6232D            | REAR        | S    | <b>SUZUKI</b><br>DL 650 K4/K5/K6/AK7/K7 V-Strom 04-07<br>DL 1000 K2-K7 V-Strom 02-07<br><b>KAWASAKI</b><br>KLV 1000 (LV 1000 A1H/A2H) 04-05  | 260      |
| MD6215D            | FRONT       | S    | YFM 350 FAS/FAT/FAV Bruin 4x4 04-06<br>YFM 350 ANS/ANT Bruin 2x4 04-06<br>YFM 350 FGW Grizzly 07<br>YFM 400 FAR/FAS Kodiak Auto 03-04<br>YFM 400 AR Kodiak (5VH3/4) 03<br>YFM 400 FAT/FAV (Big Bear) 05-06<br>YFM 450 FAR/FAS Kodiak (5ND3/4) 03-04<br>YFM 450 FAT/FAHT/FAV (Kodiak) 05-06<br>YFM 450 FXV Wolverine 06 | 200      | MD6233D            | REAR        | S    | TRX 450 R4/R5/R6/ER6/R7/ER7 04-07  | 190      |
| MD6216D            | REAR        | S    | <b>KTM</b><br>60/65 SX 00-01<br>65 SX 00-03  | 160      | MD6234D            | REAR        | S    | XT 660 X Supermoto 04-07<br>XT 660 R 04-07   | 245      |
| MD6217D            | REAR        | S    | TRX 650 FA3/FA4/FA5 Rincon 03-05<br>TRX 680 FA6/7 06-07<br>TRX 680 FGA6/FGA7 Fourtrax Rincon 06-07   | 170      | MD6235D            | FRONT       | F    | DT 125 X 04-06<br>XT 660 R 04-07   | 298      |
| MD6218D            | REAR        | S    | Predator 500 03-04   | 196      | MD6236D            | REAR        | S    | YFM 350 S/T/N/R-VW/RW Raptor 04-07<br>YFZ 450 S/T 04-05  | 200      |
| MD6219D            | FRONT       | S    | Predator 500 03-04<br>Phoenix 200 05   | 178      | MD6237D            | REAR        | S    | YFS 200 R/S/T/V 03-06<br>YZF 350 U/B/D/E/F/G/H/J/K/L /M/N/P/R/S/T/V Banshee 88-06<br>YFM 660 RN/RP/RR /RS/RT Raptor 01-05  | 220      |
| MD6220D            | FRONT       | S    | <b>BOMBARDIER</b><br>Rally 200 03-06<br><b>CAN AM</b><br>Rally 200 07  | 155      | MD6238D            | FRONT       | S    | USE MD6215D  |          |
| MD6221D            | REAR        | S    | <b>BOMBARDIER</b><br>Rally 200 03-04   | 155      | MD6239D            | FRONT       | S    | KLX 250 G1/G1A/H1 Super Sherpa 97-98<br>KL 250 J1-J3 00-02   | 240      |
| MD6222D            | FRONT       | S    | <b>BOMBARDIER</b><br>Outlander 330/400 03-04<br>Outlander 800 06<br><b>CAN AM</b><br>Outlander 400/500/650/800 07<br>Outlander Max 400/500/650/800 07  | 205      | MD6240D<br>MD6240C | FRONT       | S    | 250 SBK2 (LX 250 L) 02<br>KLX 250 J1-J6 D-Tracker 98-03  | 250      |
|                    |             |      |  |          | MD6241D            | FRONT       | S    | YXR 66 FAS Rhino 4x4 Side x Side 04  | 200      |
|                    |             |      |  |          | MD6242D            | REAR        | S    | YXR 66 FAS Rhino 4x4 Side x Side 04  | 165      |



\* = Note - Twin disc front - order D suffix for LHS - DR suffix for RHS

# OFF ROAD DISC BUYERS GUIDE

| DISC No.                               | FRONT/ REAR  | TYPE | MODELS  | DIA (MM) | DISC No.  | FRONT/ REAR | TYPE | MODELS  | DIA (MM) |
|--|--|------|---|----------|-----------|-------------|------|---|----------|
| MD6243C                                | FRONT  | S    | <b>KTM</b> 65 SX 04-07  | 198      | MD6267D   | FRONT       | S    | <b>KYMCO</b>  | 180      |
| MD6244D                                | REAR   | S    | XT 225 W (4JG1-6 Serrow) 93-98<br>XT 250 Tricker (5XT1) 04-06   | 203      |           |             |      | Mxer 50 (Quad) 00-07<br>MXU 50 05-07<br>KXR 250 04-06<br>MXU 250 04-06<br>Maxxer 300 06<br>MXU 300 SD 05-06   |          |
| MD6245D                                | FRONT  | S    | Traxter Max 650 04-05<br>Traxter XL (7920/7921) 04<br>Quest Max/STD/XT 04-05<br><b>JOHN DEERE ATV</b><br>Trail Buck 500 Utility 04-05<br>Trail Buck 650/650 EX/EXT 04-05<br>Buck 500/500 EX/EXT 04-05 | 203      | MD6268D   | REAR        | S    | <b>KYMCO</b><br>KXR 250 04-06<br>MXU 250 04-06<br>Maxxer 300 06   | 220      |
| MD6246D<br>MD6246C                     | REAR   | S    | RM 85 LK5/K5/LK6/K6/LK7/K7 05-07  | 200      | MD6269D   | REAR        | S    | 950 Adventure/S 04-06   | 240      |
| MD6247D<br>MD6247C                     | FRONT<br> | F    | DRZ 400 SMK5/SMK6/SMK7 05-07  | 310      | MD6270D/C | FRONT       | F    | <b>KTM</b> SMR 450/525 05-07<br><b>HUSABERG</b><br>FS 650 E Supermoto 05-07   | 310      |
| MD6248D                                | REAR   | S    | <b>DERBI</b> Senda-R 00-07<br>(Check application pages)   | 180      | MD6271D   | FRONT       | S    | <b>ARCTIC CAT</b><br>XT 650 H1 Prowler 06   | 252      |
| MD6249C                                | REAR   | S    | <b>KTM</b> 65 SX 04-07  | 160      | MD6272D   | FRONT       | S    | <b>POLARIS</b><br>Hawkeye 300 2x4/4x4 06  | 198      |
| MD6250D                                | FRONT  | S    | <b>DERBI</b> Senda-R 00-07<br>(Check application pages)   | 230      | MD6273D   | REAR        | S    | <b>POLARIS</b><br>Hawkeye 300 2x4/4x4 06  | 202      |
| MD6251D                                | FRONT  | S    | YFM 450 FGW Grizzly 07<br>TRX 500 FA5/FA6/FA7 05-07<br>TRX 500 FGA5/6/7 05-07<br>TRX 680 FGA6/FGA7 06-07<br>TRX 680 FA6/7 06-07   | 180      | MD6274D   | FRONT       | S    | Cobra 220 (Quad) 06-07<br>Overland 300 (Quad) (AT20) 06-07  | 173      |
| MD6252D                                | REAR   | S    | YFM 400 FAT/FAV (Big Bear) 05-06<br>YFM 450 FAT/FAHT/FAV (Kodiak) 05-06<br>YFM 400/450 FGW Grizzly 07   | 220      | MD6275D   | REAR        | S    | Sportsman 500 X2 06<br>Ranger 500 (2x4/4x4) 06<br>Ranger 500 (4x4 EFI) 06<br>Ranger 6x6 EFI 700 06<br>Ranger XP 700 4x4 06<br>Ranger TM 06                                | 218      |
| MD6253D                                | REAR   | S    | <b>GAS-GAS</b><br>See application pages   | 210      | MD6276D   | REAR        | S    | <b>CCM</b><br>404 E 03-04<br>404 DS 03-04<br>404 DS Supermoto 03-04<br>604 E DS 98-03<br>604 E Supermoto 99-03<br>604 RS 00-03<br>644 DS/SM 04<br>R30 (Spoke Wheel) 02-04 | 220      |
| MD6254D<br>MD6254C<br>OS/SM6254        | FRONT  | S    | RM-Z 250 K7 07<br>RM-Z 450 K5/K6/K7 05-07   | 250      | MD6277D   | FRONT       | S    | LTR 450 K6/K7 06-07   | 160      |
| MD6255D<br>MD6255C                     | REAR   | S    | RM-Z 250 K7 07<br>RM-Z 450 K5/K6/K7 05-07   | 240      | MD6278D   | REAR        | S    | LTR 450 K6/K7 06-07   | 190      |
| MD6256D                                | REAR   | S    | Scrambler 500 05  | 203      | MD6279D   | FRONT       | S    | <b>MALAGUTI</b><br>XSM 50 Supermotard 03-07<br><b>YAMAHA</b><br>DT 50 X (Supermotard) 04-07<br>XT 125 R 05-07   | 190      |
| MD6257C                                | REAR   | S    | KTM SX85 03-07  | 200      | MD6280D   | REAR        | S    | DT 50 R 02-07<br>DT 50 X Supermotard 02-07<br>XT 125 R 05-07<br>XT 125 X 05-07  | 220      |
| MD6258C<br>OS6258C                     | FRONT  | S    | KTM SX85 03-07  | 220      | MD6281D   | FRONT       | S    | RV 125 K2-K7 02-07<br>RV 200 K2/K3 02-03  | 220      |
| MD6259D                                | REAR   | S    | 650 Elefant 88-89<br>750 Elefant 90-92  | 240      | MD6282D   | REAR        | S    | DS 250 06<br><b>CAN AM</b><br>DS 250 07   | 190      |
| MD6260D                                | FRONT  | S    | <b>CCM</b><br>404E 03-04<br>404 DS 03-04<br>604 E DS 98-03  | 260      | MD6283D   | FRONT       | S    | DS 250 06<br><b>CAN AM</b><br>DS 250 07   | 175      |
| MD6261D                                | FRONT  | S    | <b>SUZUKI</b><br>LT-A 450 XK7 07<br>LT-A 700 XK5/XCK6/XK6/XK7 05-07   | 200      | MD6284D   | REAR        | S    | MZ/MUZ Baghura/Mastiff 00-05<br><b>DERBI</b><br>Senda X Race 03-07<br>Senda X-treme SM Supermoto 03-07  | 245      |
| MD6262D                                | FRONT  | S    | <b>POLARIS</b><br>Trail Blazer 250 05-06<br>Trail Boss 330 05-06  | 182      | MD6285D   | REAR        | S    | Rally 200 05-06<br><b>CAN AM</b><br>Rally 200 07  | 200      |
| MD6263D                                | REAR   | S    | YFZ 450 V/W 06-07<br>YFM 700 RV/RW Raptor 06-07   | 200      |           |             |      |   |          |
| MD6264D<br>MD6264C<br>OS6264<br>SM6264 | FRONT  | F    | KX 125 M6F/M7F 06-07<br>KX 250 R6F/R7F 06-07<br>KX 250 F (T6F/T7F) 06-07<br>KX 450 F (D6F/D7F) 06-07<br>KLX 450 R (A8F) 07  | 250      |           |             |      |   |          |
| MD6265D                                | FRONT  | S    | 650 Elefant 88-89<br>750 Elefant 90-92  | 260      |           |             |      |   |          |
| MD6266D                                | FRONT  | S    | LC-4 640 Adventure 03-07<br>950 Adventure/S 04-06   | 300      |           |             |      |   |          |

\* = Note - Twin disc front - order D suffix for LHS - DR suffix for RHS

# OFF ROAD DISC BUYERS GUIDE

| DISC No.   | FRONT/ REAR | TYPE | MODELS                  | DIA (MM) | DISC No. | FRONT/ REAR | TYPE | MODELS                  | DIA (MM) |   |  |     |
|--|-------------|------|-------------------------|----------|----------|-------------|------|-------------------------|----------|---|--|-----|
| MD6286D  | REAR        | S    | DT 50 R-L (SM) 02-03    | 220      | MD6296D  | FRONT       | S    | RK6 93-96               | 240      |   |  |     |
|  |             |      | MX 50 03-05             |          | MD6297D  |             |      | FRONT                   |          | S | YAMAHA<br>DT 50 R 02-06<br>XT 125 R 05-07  |     |
| MD6287D  | REAR        | S    | <b>HUSQVARNA</b>        | 220      | MD6298D  | FRONT       | F    | 950 R Superenduro 06-07 | 300      |   |  |     |
|  |             |      | CR 125 00-01            |          | MD6299D  |             |      | REAR                    |          | F | 950 R Superenduro 06-07  | 240 |
|  |             |      | SM 125 00               |          | MD6300D  |             |      | FRONT                   |          | S | HONDA<br>FMX 650 5/6 05-06   | 296 |
|  |             |      | SM 125 S 02-07          |          |          |             |      |                         |          |   |  |     |
|  |             |      | WR 125 00-01            |          | MD6301D  |             |      | REAR                    |          | S | HYOSUNG<br>TE 50 05-07<br>TE 90 05-07<br>TE 100 05-07                                    | 160 |
|  |             |      | WRE 125 00/02-07        |          |          |             |      |                         |          |   |  |     |
|  |             |      | CR 250 00-01            |          | MD6302D  |             |      | FRONT                   |          | S | HONDA<br>TRX 450 FE7/TE7 Fourtax<br>Rancher 07<br>TRX 420 FM7/TM7 Fourtrax<br>Rancher 07 | 185 |
|  |             |      | WR 250 00-01            |          |          |             |      |                         |          |   |  |     |
|  |             |      | WR 360 00-01            |          |          |             |      |                         |          |   |  |     |
|  |             |      | TE 410 00               |          |          |             |      |                         |          |   |  |     |
|  |             |      | SM 570 R 01             |          |          |             |      |                         |          |   |  |     |
|  |             |      | TE 570 01               |          |          |             |      |                         |          |   |  |     |
| SM 610 S 02-06   |             |      |                         |          |          |             |      |                         |          |   |  |     |
| TC 610 00  |             |      |                         |          |          |             |      |                         |          |   |  |     |
| TE 610 00  |             |      |                         |          |          |             |      |                         |          |   |  |     |
| TE 610 E 02-03   |             |      |                         |          |          |             |      |                         |          |   |  |     |
| TE 610 / IE 06-07  |             |      |                         |          |          |             |      |                         |          |   |  |     |
| MD6288D<br>240 O/D<br>Floats on<br>O/E pins  | REAR        | F    | <b>HUSQVARNA</b>        | 240      |          |             |      |                         |          |   |  |     |
|  |             |      | CR 125 06-07            |          |          |             |      |                         |          |   |  |     |
|  |             |      | WR 125 06-07            |          |          |             |      |                         |          |   |  |     |
|  |             |      | TC 250 05-07            |          |          |             |      |                         |          |   |  |     |
|  |             |      | TE 250 06-07            |          |          |             |      |                         |          |   |  |     |
|  |             |      | WR 250 06-07            |          |          |             |      |                         |          |   |  |     |
|  |             |      | TE 410 06               |          |          |             |      |                         |          |   |  |     |
|  |             |      | SM 450 R 07             |          |          |             |      |                         |          |   |  |     |
|  |             |      | SMR 450 RR 06-07        |          |          |             |      |                         |          |   |  |     |
|  |             |      | TC 450 05-07            |          |          |             |      |                         |          |   |  |     |
|  |             |      | TE 450 06-07            |          |          |             |      |                         |          |   |  |     |
|  |             |      | SM 510 R 06-07          |          |          |             |      |                         |          |   |  |     |
|  |             |      | TC 510 05-07            |          |          |             |      |                         |          |   |  |     |
|  |             |      | TE 510 06-07            |          |          |             |      |                         |          |   |  |     |
| SM 610 S 06  |             |      |                         |          |          |             |      |                         |          |   |  |     |
| MD6291D  | FRONT       |      | YFM 700 FGPW Grizzly 07 | 220      |          |             |      |                         |          |   |  |     |
| MD6292D  | REAR        |      | YFM 700 FGPW Grizzly 07 | 203      |          |             |      |                         |          |   |  |     |
| MD6293D<br>4 Bolt<br>Fixing<br> | FRONT       | F    | <b>HUSQVARNA</b>        | 320      |          |             |      |                         |          |   |  |     |
|  |             |      | SM 400 R 02             |          |          |             |      |                         |          |   |  |     |
|  |             |      | SM 450 R 03-07          |          |          |             |      |                         |          |   |  |     |
|  |             |      | SMR 450 R 06-07         |          |          |             |      |                         |          |   |  |     |
|  |             |      | SM 510 R 06-07          |          |          |             |      |                         |          |   |  |     |
|  |             |      | SM 570 R 01-04          |          |          |             |      |                         |          |   |  |     |
|  |             |      | SM 610/S 02-06          |          |          |             |      |                         |          |   |  |     |
|  |             |      | SM 610 ie 07            |          |          |             |      |                         |          |   |  |     |
|  |             |      | SMR 630 06              |          |          |             |      |                         |          |   |  |     |
|  |             |      | STR 650 CRC 07          |          |          |             |      |                         |          |   |  |     |
| MD6294D<br>6 Bolt<br>Fixing<br> | FRONT       | F    | <b>HUSQVARNA</b>        | 320      |          |             |      |                         |          |   |  |     |
|  |             |      | LT 610 00               |          |          |             |      |                         |          |   |  |     |
|  |             |      | SM 610 R 00             |          |          |             |      |                         |          |   |  |     |
| SM 610 98-00   |             |      |                         |          |          |             |      |                         |          |   |  |     |
| MD6295D<br>220 O/D<br>Floats on<br>O/E pins  | REAR        | F    | <b>HUSQVARNA</b>        | 220      |          |             |      |                         |          |   |  |     |
|  |             |      | CR 125 02-05            |          |          |             |      |                         |          |   |  |     |
|  |             |      | WR 125 02-05            |          |          |             |      |                         |          |   |  |     |
|  |             |      | CR 250 02-05            |          |          |             |      |                         |          |   |  |     |
|  |             |      | TC 250 02-03            |          |          |             |      |                         |          |   |  |     |
|  |             |      | TE 250 02-05            |          |          |             |      |                         |          |   |  |     |
|  |             |      | WR 250 02-05            |          |          |             |      |                         |          |   |  |     |
|  |             |      | WR 360 02               |          |          |             |      |                         |          |   |  |     |
|  |             |      | SM 400 R 02             |          |          |             |      |                         |          |   |  |     |
|  |             |      | TE 400 02               |          |          |             |      |                         |          |   |  |     |
|  |             |      | SM 450 R 03-06          |          |          |             |      |                         |          |   |  |     |
|  |             |      | TC 450 03               |          |          |             |      |                         |          |   |  |     |
|  |             |      | TE 450 03-05            |          |          |             |      |                         |          |   |  |     |
|  |             |      | SM 510 R 06             |          |          |             |      |                         |          |   |  |     |
|  |             |      | TC 510 04               |          |          |             |      |                         |          |   |  |     |
|  |             |      | TE 510 04-05            |          |          |             |      |                         |          |   |  |     |
|  |             |      | SM 570 R 02-04          |          |          |             |      |                         |          |   |  |     |
|  |             |      | TC 570 02-03            |          |          |             |      |                         |          |   |  |     |
|  |             |      | TE 570 02-04            |          |          |             |      |                         |          |   |  |     |
|  |             |      | SM 610 ie 07            |          |          |             |      |                         |          |   |  |     |
| SMR 630 06   |             |      |                         |          |          |             |      |                         |          |   |  |     |
| STR 650 CRC 07   |             |      |                         |          |          |             |      |                         |          |   |  |     |

\* = Note - Twin disc front - order D suffix for LHS - DR suffix for RHS

# S&B FILTERS



## CUSTOM AIR FILTERS

STILL OUTSELLING ALL OTHER BRANDS S & B. Better than ever value with lower retail prices. The popular S & B Custom Filter Range now extended with NEW HIGH FLOWING OFFSET OVAL FILTERS to fit all big bikes.

S & B "OVALS" have been tested by LEDAR and shown to maintain improved and unrestricted airflow whilst offering adequate filtration. Best run dry for road use and protect from direct rainfall when bike is parked.

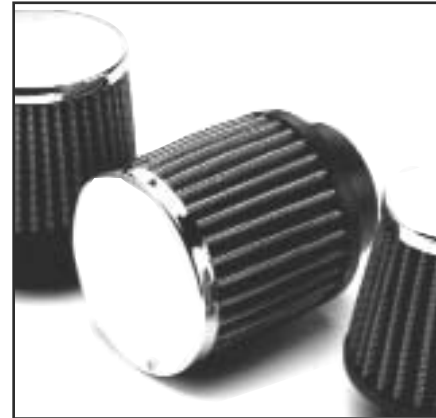

### DIMENSION CHART

| CONICAL TYPES |      |    |     |    | PARALLEL TYPES    |                         |     |    |     |
|---------------|------|----|-----|----|-------------------|-------------------------|-----|----|-----|
| FILTER No.    | A    | B  | C   | D  | FILTER No.        | A                       | B   | C  | D   |
| RC79          | 35   | 63 | 58  | 51 | RC17              | 40                      | 89  | 38 | 89  |
| RC106         | 48   | 76 | 76  | 51 | RC34              | 44                      | 114 | 38 | 114 |
| RC107         | 43   | 76 | 70  | 51 | RU99              | (Special Norton Filter) |     |    |     |
| RC120         | 52.5 | 89 | 102 | 51 | <b>OVAL TYPES</b> |                         |     |    |     |
| RC125         | 57   | 86 | 95  | 51 |                   |                         |     |    |     |
| RC135         | 55   | 88 | 104 | 88 | RC059             | 43                      | 112 | 70 | 75  |
| RC234         | 55   | 76 | 70  | 51 | RC069             | 50                      | 112 | 70 | 75  |
| RC311         | 28   | 57 | 57  | 51 | RC84              | 40                      | 72  | 51 | 51  |
| RC312         | 51   | 73 | 63  | 51 | RC098             | 55                      | 112 | 70 | 75  |
| RC313         | 43   | 76 | 60  | 51 |                   |                         |     |    |     |

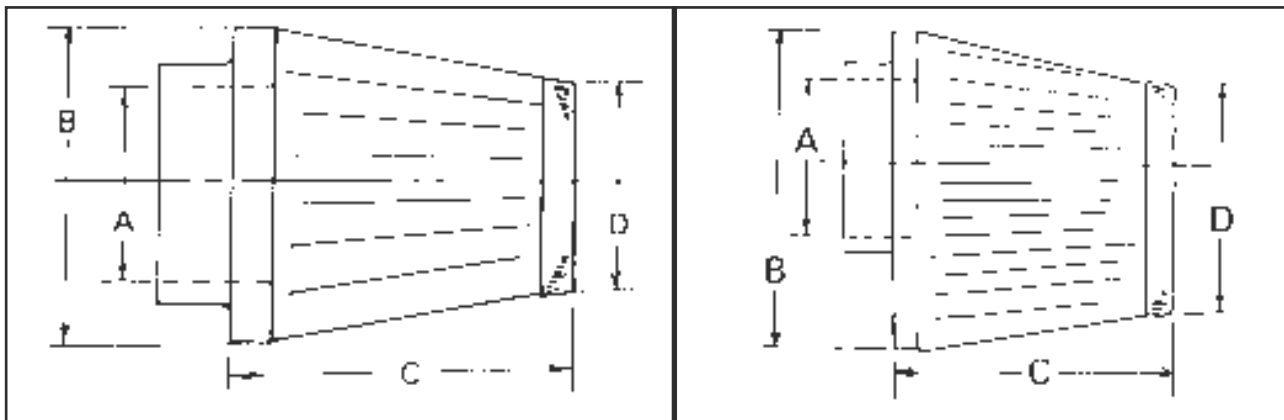

# hy-tech racing reeds

For **STREET Bikes** New CW38 Fibre for higher durability and perfect Reed block seal in high revving 2 stroke motors.

For **DIRT Bikes** New TWO STAGE Action. By using a lighter fibre on the lower reed block position New Hy-Tech "D" suffix. Reed Kits open earlier and give perfect TWO STAGE response without turbulence or early primary stage reed petal fatigue or New Carbon Fibre CF Series. See below.

## CARBON FIBRE REEDS for most Street and Dirt Bike models Prefix **CF** for Carbon Fibre.

**ROAD BIKE REEDS ALSO  
AVAILABLE IN CARBON FIBRE**  
CF02, CF11, CF15, CF18, CF81,  
CF118, CF201, CF202, CF210, CF215

| DIRT BIKE APPLICATIONS           |        | DIRT BIKE APPLICATIONS          |       | STREET BIKE APPLICATIONS                                       |        |
|----------------------------------|--------|---------------------------------|-------|--|--------|
| <b>CAGIVA</b>                    |        | <b>SUZUKI Cont.</b>             |       | <b>KAWASAKI</b>  |        |
| WMX 125/250 (1985)               | HT09D  | RM 125 H/J                      | CF18  | AE/AR 50   | HT05   |
| WMX 500                          | CF14   | RM 125 L/M/N/P/R/S              | CF78  | AE/AR 80   | HT05   |
| <b>HONDA</b>                     |        | RM 125 T/V/W/X/Y/K1-K5          | CF93  | KMX 125 (All Models)   | CF06   |
| CR 80 RC/RD/RE/RF                | HT19D  | RM 250 X-G (81-86)              | CF14  | KDX 125 A1-A2/B1-B2  | CF64   |
| CR 80 RG-R2 (86-02)              | CF48   | RM 250 H/J (87-88)              | CF06  | KR1/KR1-S  | HT81   |
| CR 85 R3-R7 (03-07)              | CF48   | RM 250 K/L (89-90)              | CF68  | <b>SUZUKI</b>  |        |
| CR 125 (All Models) up to 01     | CF18   | RM 250 M/N                      | CF83  | TS/ZR 50   | HT16   |
| CR 125 R1/R2/R3/R4               | CF208  | RM 250 P/R/S                    | CF65  | TS 100/125/185/250   |        |
| CR 250 RC/RD/RE/RF               |        | RM 250 T/V/W/X/Y/K1-K5          | CF94  | (C&ER Models)  | HT12   |
| /RG/RH                           | HT61D  | RMX 250 K/L                     | HT68D | RG 125 (All Models up to 91)                                   | CF11   |
| CR 250 RJ-RW                     | CF66   | RMX 250 M/N/P/R/S/T/V/W         | CF83  | RG 125 FUN/FUP/UN  | CF18   |
| CR 250 RX/R1/R2/R3               | CF167  | LT 250 RF/RG/RH                 | HT38  | TS 125 X (All Models)  | CF11   |
| CR 500 RE/RF/RG/RH               |        | LT 250/500 RJ/RK/RL/RM/RN       | HT68D | TS 125 RK/RL/RR  | CF18   |
| /RJ/RK                           | HT17D  | RM 465 X/Z                      | CF57  | GT 250 "X7"  | HT216  |
| CR 500 RL-R1                     | CF77   | RM 500 D/E                      | CF57  | RG 250 (All Models)  | CF211  |
| ATC/TRX 250 (All Models)         | CF06   | <b>YAMAHA</b>                   |       | RGV 250 K  | HT80   |
| <b>HUSQVARNA</b>                 |        | YZ 50 G-K                       | HT05  | RGV 250 L/M/N/P/R  | N/A    |
| 125 (82-98)                      | HT33D  | YZ 80 N-S                       | HT32D | TS 250 XE  | HT38   |
| <b>KTM</b>                       |        | YZ 80 T/U/W/A/B                 | HT46  | TS 250 XG/XH/XJ  | HT09D  |
| 125 (All Models) (84-96)         | CF22   | YZ 80 E/F/G/H/J/K/L/M/N         | CF88  | <b>YAMAHA</b>  |        |
| 250 (All Models) (84-96)         | CF22   | YZ 85 P/R/S                     | CF88  | DT/RD 50 M   | HT105  |
| 495/500 (All Models) (82-96)     | HT23D  | YZ 125 G-T/E (86-87/93)         | CF03  | DT/RD 50 MX  | HT30   |
| <b>KAWASAKI</b>                  |        | YZ 125 U-D (88-92)              | HT67D | RD 80 MX/LC  | HT05   |
| KX 60 B1-B19                     | HT40D  | YZ 125 F/G/H/J/K/L/M (94-00)    | CF89  | DT 80 MX (81-)   | HT30   |
| KX 65 A1/A2/A3/A4                | HT40D  | YZ 125 N/P/R/S/T/V/W (01-07)    | CF185 | DT 80 MX (82-)   | HT05   |
| KX 80 G1/G2/J1/J2                | HT54D  | WR 200 89-96                    | CF04  | RS 100   | HT05   |
| KX 80 L1-L3/R1-R7/W1/W3          | CF01NC | YZ 250 E-J                      | CF04  | DT/RXS 100   | HT01   |
| KX 85 A1/B1/A2/B2/A3/B3          | CF01NC | YZ 250 K                        | HT31D | DT 125 MX  | HT01   |
| KX 100 A1/A2/B1-B7/C1-C3         | CF01NC | YZ 250 L-U                      | HT07D | RD 125/200   | HT205  |
| KX 125 (All Models) (82-93)      | CF64   | YZ 250 W-H                      | CF04  | DT 125 LC/LC2  | HT02R  |
| KX 125 K1-K3                     | CF78   | YZ 250 J/K/L/M/N/P/R/S/T        | CF150 | RD 125 LC MK1-3  | HT02R  |
| KX 125 K4-M7F                    | N/A    | YZ 465 G/H                      | CF04  | DT 125 R   | HT15   |
| KDX 200 (All Models)             | CF64   | YZ 490 J to L                   | CF04  | RS 125   | HT01   |
| KDX 220 A4-A10                   | CF64   | YZ 490 N to U                   | HT07D | TZR 125/TDR 125  | HT15   |
| KX 250 C2/D1/D2/E1/F1/G1/H1      |        | IT 125/175/200 "All Models"     | CF03  | DT 175 MX  | HT01   |
| /H2/J1/J2/K1/K2/K3               | CF14   | IT 250 D/E/F                    | CF03  | DT 250/400   | CF18   |
| KX 250 K4/K5/L1/L2               | CF66   | IT 250 E/F/G/H                  | CF04  | DT 250/400 MX  | HT29D  |
| KX 250 L3/L4/M1/M2               | CF184  | TY 80/175                       | HT05  | RD 250/350/400   |        |
| KX 500 A2/B1                     | HT20D  | TY 250                          | HT01  | (Air Cooled)   | HT201R |
| KX 500 B2/C1/D1/E1-E15           | CF57   | TY 250 S/R                      | HT29D | RD 250/350 LC  | HT201R |
| <b>MAICO</b>                     |        | WR 250 ZB/ZD/ZE/ZF/ZG/ZH/ZJ     | CF04  | TDR/TZR 250  | HT215  |
| 250/490                          | CF06   | <b>STREET BIKE APPLICATIONS</b> |       | RD 350 YPVS  | HT202R |
| <b>SUZUKI</b>                    |        | <b>HONDA</b>                    |       | <b>CARBON FIBRE REEDS</b>                                      |        |
| RM 80 G/H/J                      | HT56D  | MB/MT/MTX 50                    | HT21  | Last longer, work better - increase<br>rev range & performance |        |
| RM 80 K/L/M/N/P/R/S/T/V/W/X/Y/K1 | CF48   | MBX 50                          | HT34  |  |        |
| RM 85 K2/K3/K4                   | CF48   | MBX/MTX 80                      | HT34  |  |        |
|                                  |        | H 100                           | HT21  |  |        |
|                                  |        | MBX 125                         | HT36  |  |        |
|                                  |        | MTX 125/200                     | HT36  |  |        |
|                                  |        | NS 125 FG/FH/RK/RL              | HT210 |  |        |
|                                  |        | NSR 125 All models              | HT118 |  |        |

# MAIN JETS/JET BOXES

## R.D. Engineering



## PRECISION BRASS MAIN JETS

### PART NO. CRK 30

(Contains 30 sizes for Keihin Carbs, Hex Head Style.  
2 jets per size, sizes 80 to 225 in steps of 5).

### PART NO. HJK36

(Contains 36 sizes for Mikuni Carbs, Hex Head Style.  
2 jets per size, sizes 70 to 420 in steps of 10).

### PART NO. KJK 36

(Contains 36 sizes for Keihin Carbs, Slot Head Style.  
4 jets per size, sizes 72.5 to 160 in steps of 2.5).

### PART NO. SJK 36

(Contains 36 sizes for Mikuni Carbs, Slot Head Style.  
4 jets per size, sizes 72.5 to 160 in steps of 2.5).

|  |  |  |  |
|--|--|--|--|
|  | <p><b>DELL'ORTO<br/>(STYLE 6413)</b></p> <p>20 Different Sizes 100 thru<br/>200 in steps of 5<br/>For Loose Jets<br/>ORDER No. DO (Size)<br/>Packets of 5 pcs</p>                      |  | <p><b>STYLE: MIK<br/>(N 100/604)</b></p> <p>Fit Mikuni Carbs<br/>(on most Suzuki's)<br/>72.5 to 160 in steps of 2.5<br/>For Loose Jets<br/>ORDER No. SJ (Size)<br/>Packets of 4 pcs</p>                        |
|  | <p><b>KEIHIN<br/>(HEX HEAD STYLE)</b></p> <p>2 pcs each<br/>30 different Sizes<br/>80 thru 225 in steps of 5<br/>For Loose Jets<br/>ORDER No. CR (Size)<br/>Packets of 4 pcs</p>       |  | <p><b>JB36</b></p> <p>36 Compartment Box<br/>(10" x 7" x 11/2")</p>  |
|  | <p><b>STYLE: KEIH<br/>(N102 221)</b></p> <p>Fit Keihin Carbs<br/>(on most Honda's)<br/>72.5 to 160 in steps of 2.5<br/>For Loose Jets<br/>ORDER No. KJ (Size)<br/>Packets of 4 pcs</p> |  | <p><b>STYLE: HEX<br/>(4/042)</b></p> <p>Popular Hexagon Style in most<br/>Mikuni Two Stroke Carbs.<br/>Sizes:<br/>70 to 450 in steps of 10<br/>For Loose Jets<br/>ORDER No. HJ (Size)<br/>Packets of 4 pcs</p> |
|  |  |  |  |
|  |  |  |  |

ACCESSORY  
PAGES

# LEDAR NOZZLES

## LEDAR POWER NOZZLES 2 STROKE DETAILS

- Simply Change standard OE Nozzle for Immediate Power Boost.
- More Power through the range.
- Better Carburation, improved specific fuel consumption.
- Less Unburnt Hydro Carbons means cleaner exhaust & less pollution.



|  | NOZZLE No. | FITMENT                                       |
|--|------------|---|
|  | LN43       | RD 125 LC Mk 1/Mk 1 2 (Not YPVS)<br>DT 125 MX |
|  | LN44       | DT 125 LC/RXS 100                             |
|  | LN45       | RD 80 LC                                      |
|  | LN46       | MBX 125/MBX 50                                |
|  | LN59       | AR 50/AE 50/AR 80                             |
|  | LN61       | AR 125 LC                                     |
|  | LN63       | RD 125 LC Mk 3 (YPVS)                         |
|  | LN66       | GP 100  |
|  | LN66A      | GP 100 Big Bore 125 Conversion                |
|  | LN67       | RG 125  |
|  | LN68       | NS 125 FH/FG/RK                               |
|  |            |   |
|  |            |   |
|  |            |   |

## BAFFLE PAC

### BAFFLE-PAC-Silencer Glass. PART NO. BP-1

This material is labelled and conforms to BSAU 193T2. BEWARE of distributors selling cheaper roofing felt in its place. Repackable Tailpipes as the name implies require regular cleaning and repacking with BSAU approved "SILENCER GLASS" such as Winning BAFFLE PAC. Failure to maintain tailpipes in such a way will lead to clogging of the silencer wool and raised noise output together with reduced engine performance. Freeman Automotive (nor Dealers) are responsible for noise offences due to lack of maintenance as described above. "Recommended repacking period is every 3000 miles on two-strokes or when bike becomes noisy if sooner".

## BRAKE FLUID

# EBC BRAKE FLUID



- DOT 3** - A regular quality polyglycol fluid.
- DOT 4** - A refined specification polyglycol fluid as fitted to most faster street bikes now produced.
- DOT 5** - Silicone fluid as used in Harley Davidson Motorcycles and many special High Performance Brake systems.
- NEW BF307** - Highly refined Dot 3 Brake fluid, ideal for Racing or High performance Road bikes. Can be used in all systems specifying Dot 3 or Dot 4 but **NOT** with (Dot 5) silicone fluids.

EBC Brake Fluid is available in DOT 3, DOT 4 or DOT 5 (Silicone) Grades or new BF 307 Race Grade.

### TO ORDER USE THESE NUMBERS

|                                 |        |
|---------------------------------|--------|
| DOT 3 (Six Pack) .....          | BF 003 |
| DOT 4 (Six Pack) .....          | BF 004 |
| DOT 5 (Six Pack) (Silicone).... | BF 005 |
| BF 307 (Six Pack) .....         | BF 307 |



# GALINDO/BAJA GRIPS



**NEW**

USE HIGH RES SCANS FROM 2000 CATALOGUE AND TURN INTO PANTONE 560

## 4 1/2" GALINDO Superbike Grips

Made in USA with KRATON G material. Without doubt the highest quality grip sold worldwide for street bikes. New '96 format with all below colours at 4.1/2" with separate spacer ring to accommodate 5" throttle units. Complete with heavy plastic bar end plugs & new high visual "Clamshell" packaging.

| Colour | Part No. | Colour | Part No. |
|--------|----------|--------|----------|
| Black  | GX01     | Blue   | GX03     |
| Red    | GX02     |        |          |

4 1/2" Galindo Superbike grips

**hy-tech**  
racing reeds

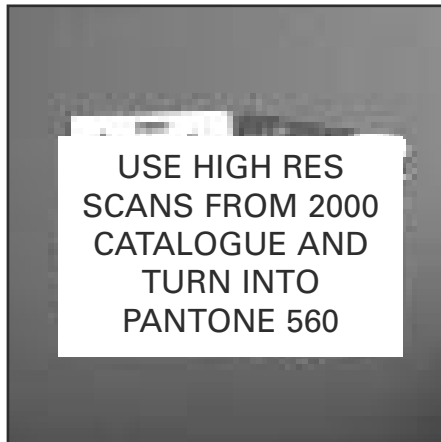

USE HIGH RES SCANS FROM 2000 CATALOGUE AND TURN INTO PANTONE 560

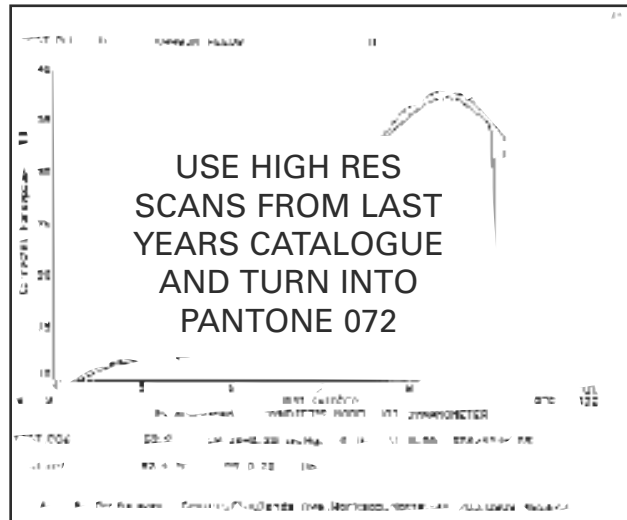

USE HIGH RES SCANS FROM LAST YEARS CATALOGUE AND TURN INTO PANTONE 072

**STREET** - CW38 fibre still ideal for smaller high revving two strokes but new for track or road Hy-Tech **CARBON FIBRE** reeds for these designs suffix regular part No with "CF" to order.

**DIRT** - Two stage system with stiffer top reed and standard lower reed gives wider power band + longer reed life on upper reed block position.

**OR** - NEW CF Carbon Fibre series now available.

### NEW CARBON REEDS More Torque - More Horses

All the way - Hy-Techs new Carbon reeds out perform the, previous market best. (Test done on RD 250 LC, in 4th gear at full throttle). Thanks to Shawn Webster at R&S Performance Centre for use of his Dynojet rolling road and expertise. (R&S phone # 0909 482670)  
**A FULL HORSEPOWER IMPROVEMENT AT TOP END**

Hy-Tech Racing Reeds



USE HIGH RES SCANS FROM 2000 CATALOGUE AND TURN INTO PANTONE 560

## BAJA FOAM GRIPS

BAJA Foam grips made in USA with "reticulated" foam closed cell construction. Sounds fancy but what it means is Baja foam grips do not "sponge" up water as will other cheap open cell foam rubber units. Complete with bar caps and mounting glue.

| Colour | Part No. |
|--------|----------|
| Black  | BG01     |
| Red    | BG02     |
| Blue   | BG03     |

Baja foam grips